

Eaton 9PXM UPS

Eaton 9PXM UPS

4–20kVA Users Guide



Powering Business Worldwide

p/n: P-164000669
Revision 10

Class A EMC Statements

FCC Part 15

 **NOTE** This equipment has been tested and found to comply with the limits for a Class A digital device, pursuant to part 15 of the FCC Rules. These limits are designed to provide reasonable protection against harmful interference when the equipment is operated in a commercial environment. This equipment generates, uses, and can radiate radio frequency energy and, if not installed and used in accordance with the instruction manual, may cause harmful interference to radio communications. Operation of this equipment in a residential area is likely to cause harmful interference in which case the user will be required to correct the interference at his own expense.

ICES-003

This Class A Interference Causing Equipment meets all requirements of the Canadian Interference Causing Equipment Regulations ICES 003.

Cet appareil numérique de la classe A respect et outes les exigences du Reglement sur le matériel brouilleur du Canada.

IEC 62040-2

Some configurations are classified under IEC 62040-2 as "C2 UPS for Unrestricted Sales Distribution."

Eaton reserves the right to change specifications without prior notice. Eaton reserves the right to change specifications without prior notice. Modbus is a registered trademark of Schneider Automation, Inc. MOXA is a registered trademark and MGate is a trademark of MOXA, Inc. Spiralock is a registered trademark of Spiralock Corporation. KIRK is a registered trademark of Kirk Key Interlock company, LLC, a subsidiary of Halma plc. National Electrical Code and NEC are registered trademarks of National Fire Protection Association, Inc. ERIFLEX and FLEXIBAR are registered trademark of Erico International Corporation. All other trademarks are property of their respective companies. All other trademarks are property of their respective companies.

©Copyright 2020 Eaton, Raleigh, NC, USA. All rights reserved. No part of this document may be reproduced in any way without the express written approval of Eaton.

Special Symbols

The following are examples of symbols used on the product to alert you to important information:



RISK OF ELECTRIC SHOCK - Observe the warning associated with the risk of electric shock symbol.



CAUTION: REFER TO OPERATOR'S MANUAL - Refer to your operator's manual for additional information, such as important operating and maintenance instructions.



This symbol indicates that you should not discard the product in the trash. This product must be disposed of properly. For more information, contact your local recycling/reuse or hazardous waste center.



This symbol indicates that you should not discard waste electrical or electronic equipment (WEEE) in the trash. For proper disposal, contact your local recycling/reuse or hazardous waste center.



IMPORTANT

To ensure you have the most up-to-date content and information for this product, please review the latest manual revision on our website, Eaton.com/9PXM.

Table of Contents

1 Introduction	1
1.1 Introduction	1
1.2 Safety Warnings	1
1.3 Physical Features	3
2 Installation Setup	9
2.1 Preparing for Installation	9
2.2 Equipment Clearances	9
2.3 Location Requirements	9
2.4 UPS Setup	9
2.5 Anchor Bracket Installation	11
2.6 Rack-Mount Installation	12
3 UPS With External Bypass Installation	15
3.1 Installation of the UPS with an External Bypass Switch	15
3.2 Circuit Breaker Input Ratings	16
3.3 UPS Connections	17
3.4 BPM Signal Input Wire Routing	22
3.5 System Wiring Diagrams	25
3.6 Bypass Overview	28
3.7 No Break Transfer from UPS Mode to Service Mode	29
3.8 Lock-out/Tag-out	30
3.9 No Break Transfer from Service Bypass to UPS Mode	31
4 UPS Electrical Installation	35
4.1 UPS Input Current Ratings	35
4.2 UPS Electrical Installation	37
4.3 System Wiring Diagram	40
5 Battery Cabinet Installation	43
5.1 Battery Cabinet Options	43
5.2 Standard Battery Cabinet Installation	43
5.3 Connected Battery Cabinet With No AC Input	46
5.4 Connected Battery Cabinet With 120VAC Input	49
5.5 Connected Battery Cabinet With Split Phase Input	53
6 UPS Startup	59
6.1 UPS Startup	59
6.2 UPS Startup Without an External Bypass Switch	61
6.3 Startup for Units Installed with an Eaton BPM Bypass Switch	62
6.4 Startup for Units installed with a BPE Type Switch	63
6.5 Initial Startup Parameters	65

Table of Contents

7 Operation.....	67
7.1 Normal Operation	67
7.2 UPS Standby Mode.....	67
7.3 UPS Shutdown	67
7.4 Operating Modes	67
7.4.1 Online Mode.....	67
7.4.2 Battery Mode.....	68
7.4.3 Low Battery Warning.....	68
7.4.4 Bypass Mode.....	68
7.5 Return of AC Input Power.....	69
7.6 Configuring Bypass Settings	69
7.7 Configuring Battery Settings	70
7.7.1 Advanced Battery Management.....	70
7.7.2 Auto Battery Test.....	70
7.7.3 Low Battery Warning.....	70
7.7.4 External Battery Setting	70
7.7.5 Deep Discharge Protection	70
7.8 Retrieving the Event Log	70
7.9 Retrieving the Fault Log	70
7.10 Control Panel Operation	70
7.11 Display Functions.....	71
7.12 LCD Description	72
7.13 Display Status Indicators	72
7.14 Changing Parameter Settings	73
7.15 Display Menu Screens	73
8 Communication	87
8.1 Intelligent Power Manager.....	87
8.2 Optional Interface Kits	87
8.3 Communication Ports	87
8.4 Dedicated Input Signals	88
8.5 DB-9 Communication Port	90
8.6 Communication Slots	90
9 Maintenance.....	93
9.1 Routine Maintenance	93
9.2 Storage Temperature	93
9.3 External Bypass Switch (Make Before Break Only) Operation.....	93
9.4 Battery Replacement.....	94
9.5 Power Module Replacement.....	95
9.6 UPS Firmware Upgrade	96
10 Specifications	97

10.1 Nominal Electrical Input and Output	97
10.2 Combined UPM Power Ratings	97
10.3 Circuit Breakers	98
10.4 Environmental and Safety	98
10.5 Battery Ratings	99
10.6 Output Run Times	99
10.7 Weights and Dimensions	99
10.8 Output Receptacles	100
10.9 Receptacle Circuit Breaker Ratings	101
11 Troubleshooting	103
11.1 Troubleshooting	103
11.2 Service and Support	106
11.3 Two-Year Limited Warranty	106

Table of Contents

List of Figures

Figure 1.	Eight and Twelve-Slot Cabinets (Front View)	3
Figure 2.	Twelve-Slot Rear View Access	4
Figure 3.	Power Modules and Battery Slots	5
Figure 4.	Battery Modules per Slot	6
Figure 5.	Uninterruptible Power Module	6
Figure 6.	UPS Control Panel	7
Figure 7.	UPS on Shipping Pallet	10
Figure 8.	Moving the UPS from the Pallet	11
Figure 9.	Floor Anchor Bracket Installation	12
Figure 10.	Rack-Mount Ear installation	13
Figure 11.	Rack Tray Location	13
Figure 12.	Remove Cabinet from Castor Tray	14
Figure 13.	Securing the UPS in the Rack.....	14
Figure 14.	Typical Installation with a Bypass Switch.....	15
Figure 15.	BPM Bypass Bottom	17
Figure 16.	UPS AC Power Terminal Access.....	18
Figure 17.	Split-Phase Power Modules.....	19
Figure 18.	UPS Input and Output Terminals	20
Figure 19.	Bypass Switch Wiring Label and Terminal Blocks.....	21
Figure 20.	UPS Input Control Signal Wiring for Maintenance Bypass	22
Figure 21.	BPE to UPS Connector	23
Figure 22.	Three-Pin BPM to UPS Connector.....	23
Figure 23.	Forced and Maintenance Bypass Screens	24
Figure 24.	Wiring Diagram- UPS with External Bypass Switch (BPM) (L1, L2, N)	26
Figure 25.	Wiring Diagram- UPS with External Bypass Switch (BPE) (L1, L2, N)	27
Figure 26.	Bypass Switch Positions.....	28
Figure 27.	Bypass From UPS to LINE.....	30
Figure 28.	Bypass From LINE to SERVICE	30
Figure 29.	LOTO Feature	31
Figure 30.	From SERVICE to LINE.....	32
Figure 31.	From LINE to UPS	32
Figure 32.	Typical Installation without a Bypass Switch.....	35
Figure 33.	UPS Power Terminals	37
Figure 34.	Split-Phase Power Modules.....	38
Figure 35.	UPS Input and Output Terminal Connections.....	39
Figure 36.	UPS with No External Bypass (L1,L2,N)	41
Figure 37.	Standard EBM Front and Back	44
Figure 38.	Standard EBM to UPS Connections.....	45
Figure 39.	EBM Emergency Disconnect Switch	46

List of Figures

Figure 40.	Connected EBM Front And Back	47
Figure 41.	Connected EBM (No AC Input Option)	48
Figure 42.	EBM Emergency Disconnect Switch	49
Figure 43.	Connected EBM Front And Back	50
Figure 44.	Connected EBM (120V AC Option).....	51
Figure 45.	UPS Input Control Signal Wiring (For External Controls)	52
Figure 46.	Securing The CAN Ground Wire	52
Figure 47.	EBM Emergency Disconnect Switch	53
Figure 48.	Connected EBM Front And Back	54
Figure 49.	Connected EBM (Split Phase Input).....	55
Figure 50.	UPS Input Control Signal Wiring (For External Controls)	56
Figure 51.	Securing The CAN Ground Wire	56
Figure 52.	EBM Emergency Disconnect Switch	57
Figure 53.	Inserting the Modules	60
Figure 54.	EBM Battery Modules and Charger	60
Figure 55.	Communication Ports.....	61
Figure 56.	UPS Control Panel	71
Figure 57.	LCD Display Status Indicators	72
Figure 58.	Display Status Indicators.....	73
Figure 59.	Start Screen	74
Figure 60.	Status Screen Menu	74
Figure 61.	Measurements Menu	75
Figure 62.	Control Menu	76
Figure 63.	Local Setting Menu	77
Figure 64.	In/Out Settings Menu.....	78
Figure 65.	On/Off Settings Menu.....	79
Figure 66.	Battery Settings Menu	80
Figure 67.	Input Signals Menu.....	81
Figure 68.	Comm Settings Menu	82
Figure 69.	Password Menus	83
Figure 70.	Event Log	83
Figure 71.	Fault Log Menu	83
Figure 72.	Identification Menu.....	84
Figure 73.	Register Product Menu	85
Figure 74.	UPS Communications Ports	88
Figure 75.	EBM Communication Port.....	88
Figure 76.	Normally Open Connections	89
Figure 77.	EPO Normally Closed Connections	89
Figure 78.	Battery Replacement	94
Figure 79.	Power Module Replacement	95
Figure 80.	Compatible Output Receptacles	100

List of Tables

Table 1.	Recommended Breaker Sizes	16
Table 2.	Recommended Wire Sizes	16
Table 3.	Bypass Switch Positions	29
Table 4.	BPM Dimensions	33
Table 5.	UPS Recommended Breaker Sizes.....	36
Table 6.	UPS Recommended Wire Sizes.....	36
Table 7.	Electrical Input and Output	97
Table 8.	Power Ratings	97
Table 9.	Circuit Breaker Sizes	98
Table 10.	Environmental and Safety.....	98
Table 11.	Battery Ratings	99
Table 12.	Weights and Dimensions	99
Table 13.	Receptacle Circuit Breaker Ratings.....	101
Table 14.	Typical Alarm Conditions	103

List of Tables

Chapter 1 Introduction

1.1 Introduction

The Eaton® 9PXM uninterruptible power system (UPS) is a modular UPS that contains two battery modules per slot (two-battery slot) and power control modules (referred to as power modules). These modules plug into a rack cabinet structure containing additional control, communication and display functions that enable integrated control of all power modules. The UPS is housed in a single cabinet with either eight or twelve slots which may be either floor or rack-mounted. Optional extra battery capacity is housed in extended battery module (EBM) cabinets.

The twelve-slot UPS cabinet can accommodate a maximum of six power modules and two battery modules per slot in the remaining six slots. However, if a customer chooses to only have one power module they can install two battery modules per slot in the remaining eleven slots. The eight-slot cabinet can accommodate the same configuration with two less total units each. Both UPS cabinet models allow their output to be limited such that an excess number of power modules allow the failure of one or more modules without causing the UPS to lose any functionality. Optional super charger modules can be installed in the power module slots.

The power modules can be removed and replaced (easily replaceable) without powering the UPS down if the UPS has sufficient redundant capacity. Battery modules (2 battery modules per slot) may also be easily replaced for maintenance. Power control circuitry in the cabinet senses problems in power modules, and automatically transfers control and load to the remaining power modules. Battery modules and Power modules are accessed through removable front panels.

All power modules share the load requirements equally. For example, three power modules are capable of supplying a total of 12 kVA. If a load requires only 6 kVA, each power module supplies 2 kVA to the output.

If one power module is removed or for some reason fails, each of the two remaining power modules would supply half of the load, or 3 kVA. In other words, redundancy exists when the load can be supplied by less than all of the installed power modules.

To permit UPS removal from the power path while maintaining power to the loads, an external bypass switch is required. This switch is optional but recommended for system serviceability.

1.2 Safety Warnings

IMPORTANT SAFETY INSTRUCTIONS - SAVE THESE INSTRUCTIONS

This manual contains important instructions that you should follow during installation and maintenance of the UPS and batteries. Please read all instructions before operating the equipment and save this manual for future reference.

- The 9PXM is a modular UPS with a power range of 4kVA to 20kVA. Each Power Module is rated for up to 4kVA. The 20kVA (N+1) Split-Phase model chassis will have twelve slots, two per row. All of the twelve slots can accommodate two battery modules per slot. The Power Modules will be restricted to the slots in only the left side of the chassis, when viewed from the front. A super charger can be installed in any of the power module slots. This super charger can also be used in an external battery module (EBM). The 16kVA (12kVA (N+1)) Models will be similar but will have eight slots.
- Do NOT install more than six power and/or optional super charger modules in the system.
- Battery modules to be used in the Eaton 9PXM system are model P-103002954. Each battery module weighs 15 kg (33 lb). Use care in lifting and moving battery modules.
- All input and output wiring must be copper and adequate to carrying currents as listed in .
- Torque all bolts holding input and output power conductors to values specified in .

- The user is required to provide power input and output disconnect devices for the UPS. These must be within sight of the UPS and easily accessible.

Consignes de Sécurité

CONSIGNES DE SÉCURITÉ IMPORTANTES – CONSERVER CES INSTRUCTIONS

Ce manuel comporte des instructions importantes que vous êtes invité à suivre lors de toute procédure d'installation et de maintenance des batteries et de l'onduleur. Veuillez consulter entièrement ces instructions avant de faire fonctionner l'équipement et conserver ce manuel afin de pouvoir vous y reporter ultérieurement.

- Les blocs de puissance à phase auxiliaire sont dotés d'étiquettes marron sur le dessus et produisent deux tensions de sortie: 110/110 pour 220, 120/120 pour 240, 120/120 pour 208, ou 127/127 pour 220 Vca.
- N'installez PAS plus de sept chargeurs de batteries optionnels et/ou de puissance dans le système.
- Les modules de batterie à utiliser dans le système Eaton 9PXM correspondent au modèle P-103002954. Chaque module de batterie pèse 15 kg (33 lb). Levez ou déplacez les modules de batterie avec soin.
- Tous les câblages d'entrée et de sortie doivent être en cuivre et doivent prendre en charge les courants répertoriés dans les .
- Couplez tous les boulons en maintenant les conducteurs de sortie sur les valeurs indiquées dans le .
- L'utilisateur doit fournir des appareils de déconnexion de l'alimentation en entrée et en sortie pour l'onduleur. Ceux-ci doivent se trouver dans le périmètre de l'onduleur et être faciles d'accès. En ce qui concerne l'unité de prise, la prise sert d'appareil de déconnexion de l'alimentation en entrée, laquelle doit également être facile d'accès.

Advertencias de Seguridad

INSTRUCCIONES DE SEGURIDAD IMPORTANTES – GUARDE ESTAS INSTRUCCIONES

Este manual contiene instrucciones importantes que debe seguir durante la instalación y el mantenimiento del SIE y de las baterías. Por favor, lea todas las instrucciones antes de poner en funcionamiento el equipo y guarde este manual para referencia en el futuro.

- Los módulos de potencia de fase dividida portan etiquetas de color café en la parte delantera y producen dos voltajes de salida: 110/110 para 220, 120/120 para 240, 120/120 para 208 ó 127/127 para 220 Vca.
- NO instale en los módulos de potencia del sistema más de siete módulos de potencia y/o de cargadores opcionales de baterías.
- Los módulos de baterías a utilizarse en el sistema Eaton 9PXM son del modelo P-103002954. Cada módulo de batería pesa 15 kg (33 lb). Levante y mueva con cuidado los módulos de baterías.
- Todo el cableado de entrada y de salida debe ser de cobre y del tipo adecuado para transportar las corrientes detalladas en la .
- Apriete todos los pernos que sostengan los conductos de alimentación de entrada y de salida según los valores de torsión especificados en la .
- Se le solicita al usuario suministrar dispositivos de desconexión de entrada y salida de alimentación para el SIE. Éstos deben estar a la vista del SIE y ser de fácil acceso.

1.3 Physical Features

The Eaton 9PXM UPS is available in eight or twelve-slot cabinet sizes. The cabinet front has a control panel and magnetic-latch front covers that provide access to the power modules and battery modules. Casters and leveling feet are installed on a caster tray for a floor-mounted UPS installation (see [Figure 1](#)).

Figure 1. Eight and Twelve-Slot Cabinets (Front View)

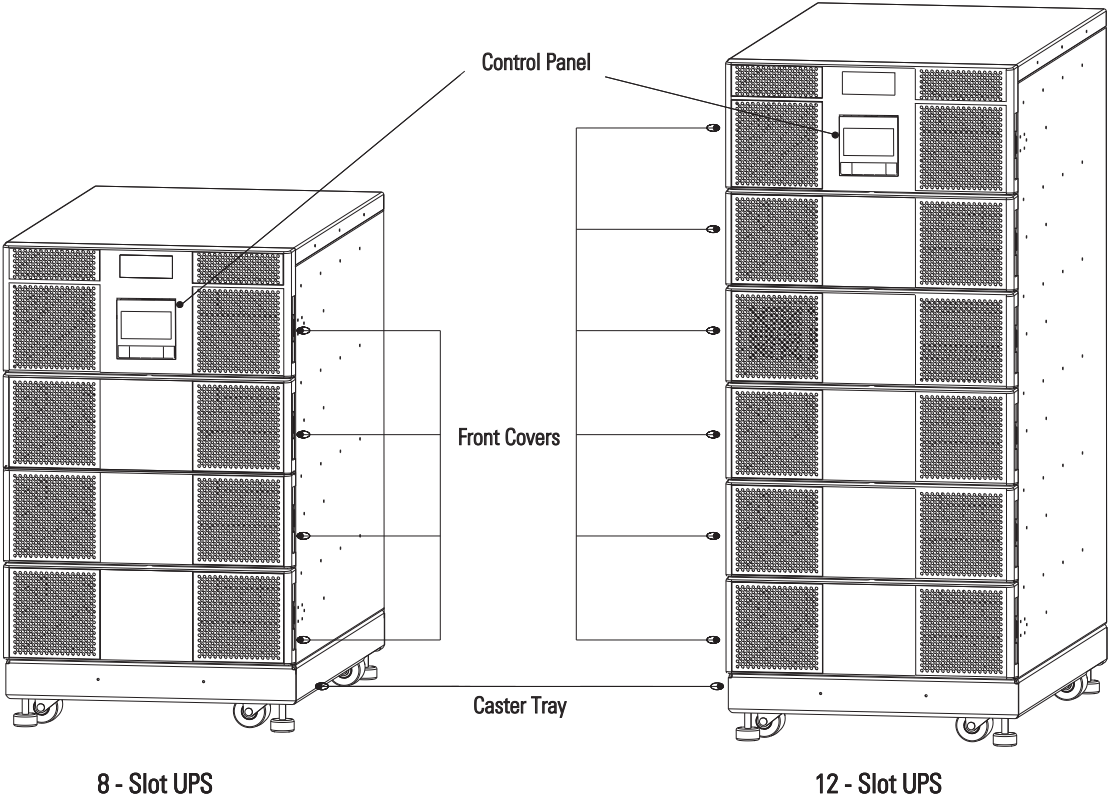

The rear UPS panel features power input and output connections with protective covers. Communication ports provide input signals for maintenance bypass, remote power off, etc. DB-9, USB ports and communication slots for network connectivity cards allow for remote monitoring of UPS operation. Slots for output receptacles installed by Eaton are available by removable knockout panels depending on the user’s requirements (see [Figure 2](#)).

Figure 2. Twelve-Slot Rear View Access

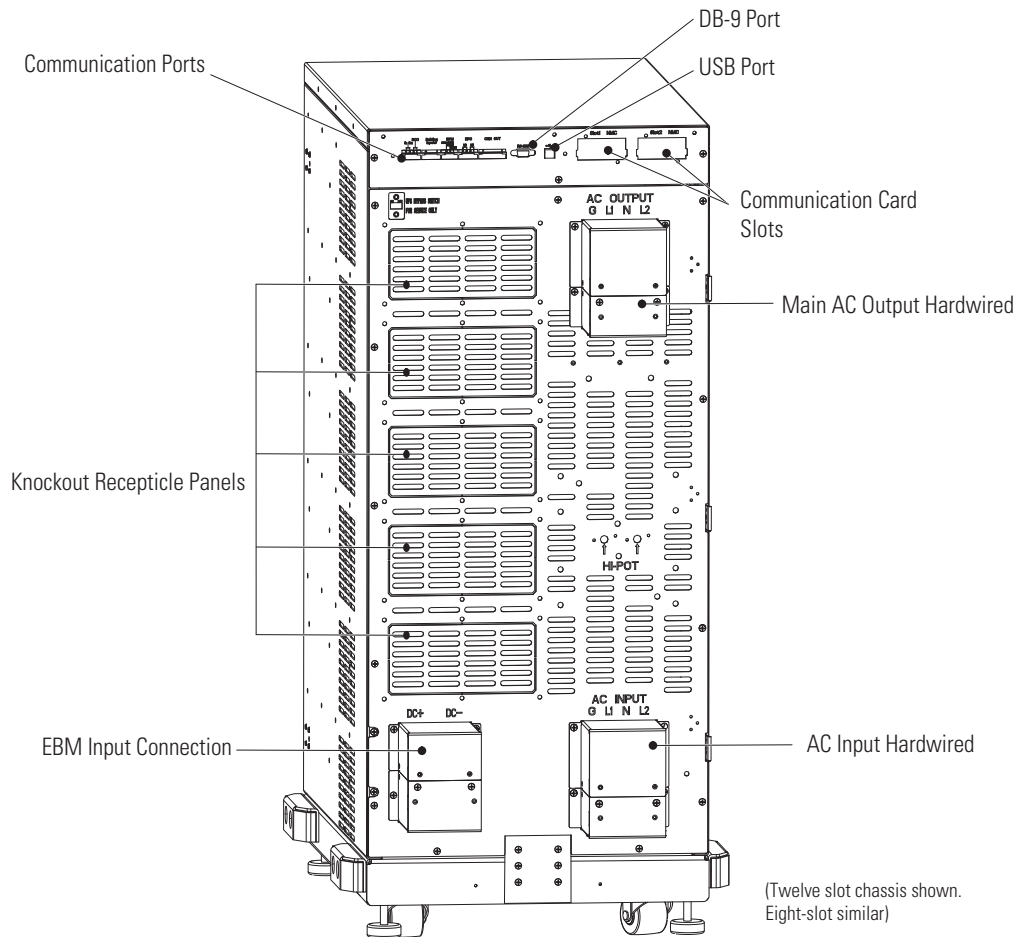

Power Modules

UPS power modules (UPMs) are installed in the left hand slots of the UPS behind the front covers. Battery slots consist of two battery modules each and can be used in both the right or left hand slots. (see [Figure 3](#).)

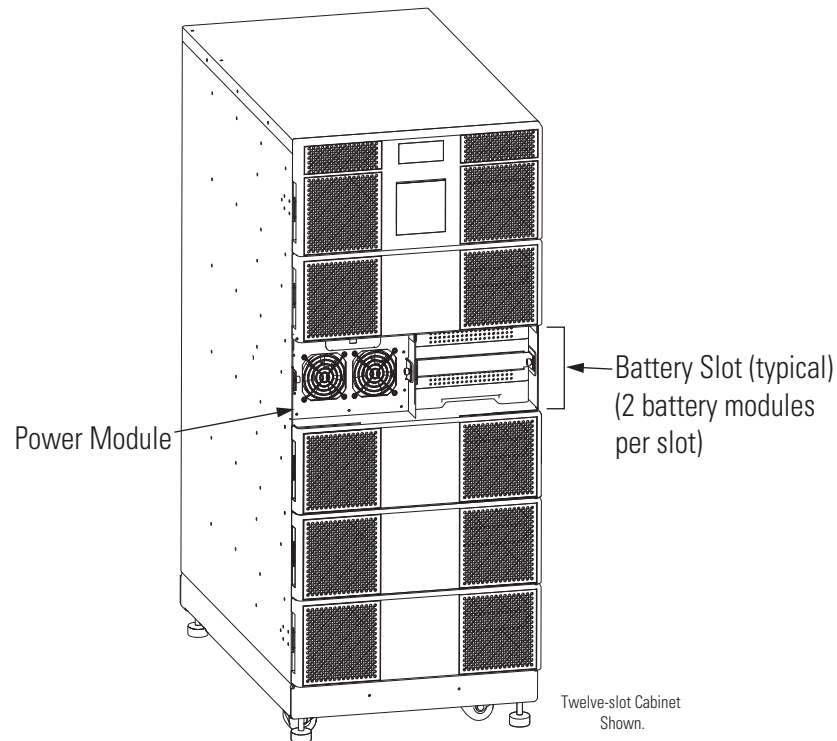
Figure 3. Power Modules and Battery Slots**Battery Modules**

As a UPS, the eight-slot 9PXM chassis can accommodate a maximum of seven two-battery slots and the twelve-slot can contain up to eleven two-battery slots. Each two-battery slot contains two battery modules that can be removed and installed separately from the battery slots in the chassis. A battery module supplies 60VDC with five 12V batteries, each 9PXM battery two-battery slot supplies 120VDC, with 10 batteries (see [Figure 4](#)).

**NOTE**

You must install one 9PXM battery string (Qty 2 battery modules) in the main UPS chassis for every power module present or the UPS will sound a “Not Enough Battery” alarm indication.

Figure 4. Battery Modules per Slot

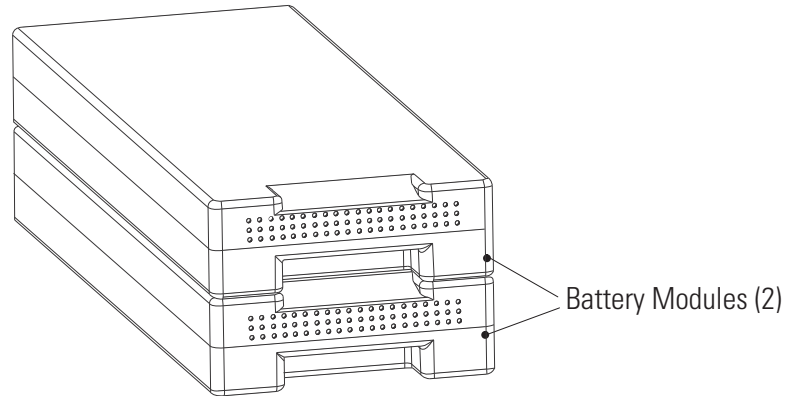

Uninterruptible Power Modules (UPM)

The eight-slot 9PXM chassis can accommodate a maximum of four power modules and the twelve-slot can contain up to six modules. Each 4kVA has a built in 5 amp battery charger and is cooled by two cooling fans. (see [Figure 5](#)). One power module (UPM) is able to fully charge five 9PXM battery strings (10 9PXM battery modules).

NOTE You must install one 9PXM battery string (2 battery modules) in the main UPS chassis for every power module present or the UPS will sound an “Not Enough Battery” alarm indication.

Figure 5. Uninterruptible Power Module

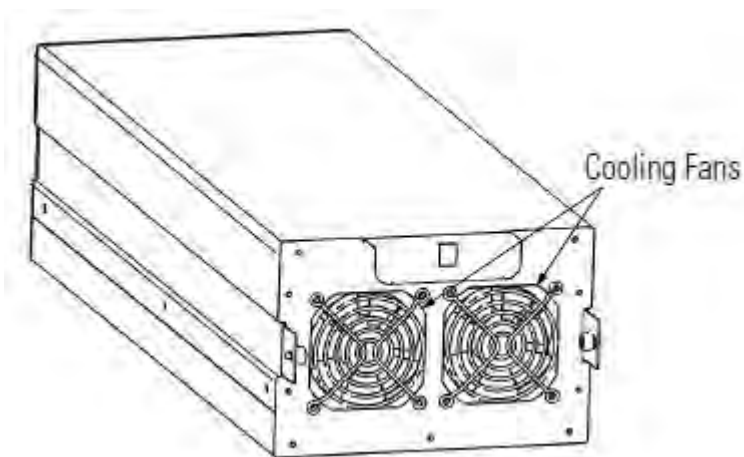

Super Charger Modules (Optional)

Super chargers have a built in 20 amp charger and are identical in appearance to power modules. They are identified separately from each other by their labels. The UPS can contain a minimum of one (optional) super charger while the "Connected" external battery module option can accommodate one in the lower left slot. One super charger is able to fully charge (22) 9PXM battery strings or (44) individual battery modules.

Control Panel

The UPS control panel has a graphical LCD screen, light indicators and function buttons. It provides information and control for the UPS, load status, events, measurements and settings. Refer to "[7.1 Normal Operation](#)" for control panel description and operation. See [Figure 6](#) .

Figure 6. UPS Control Panel

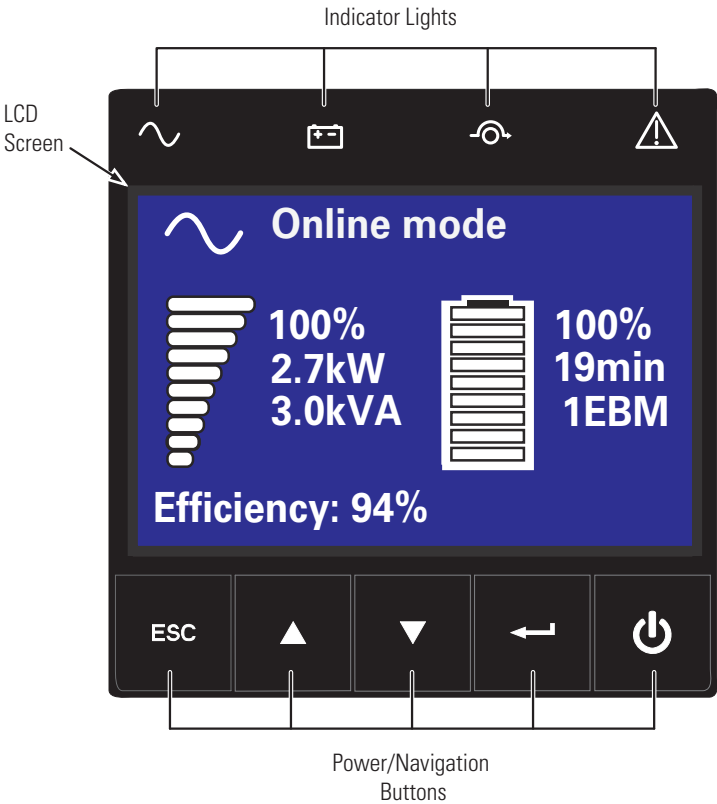

Chapter 2 Installation Setup

2.1 Preparing for Installation

This chapter explains how to set up and install the Eaton 9PXM eight and twelve-slot cabinets:

- Equipment Clearances
- Location Requirements
- UPS Setup
- Anchor Bracket Installation
- Rack-mount installation

2.2 Equipment Clearances

All cabinet sizes require the following clearances to allow for servicing and adequate ventilation:

- Sides: 15.2 cm (6")
- Top: 30.5 cm (12")
- Front: 91.5 cm (36")

Service Clearance

If flexible conduit connects the UPS to the service input and load distribution panels, you may be able to gain access for servicing by moving the UPS. If this is the case, you must still leave 30.5 cm (12") clearance at the back, 15.2 cm (6") at the sides 91.5 cm (36") at the front of the UPS for ventilation.



NOTE

Do not block the ventilation holes on each side and the back of the cabinet. Do NOT attempt to move the cabinet with the power modules or battery modules installed.

External battery cabinets may be installed with bases tight against the UPS cabinet base and against each other.

2.3 Location Requirements

Install the Eaton 9PXM UPS as close as possible to the equipment or the load distribution panel it will protect.

If a separate external battery cabinet (EBM) is installed, the battery cabinets must be adjacent to the Eaton 9PXM UPS. If the batteries will be farther from the cabinet than the standard cables allow, contact your service representative or your local distributor for assistance.

UPS cabinet dimensions are located in [10.7 Weights and Dimensions](#).

2.4 UPS Setup

The Eaton 9PXM UPS eight and twelve-slot cabinets are shipped on a shipping pallet. Power modules and battery modules are shipped in separate boxes on another pallet.



NOTE

Installation for the eight-slot cabinets are identical to the twelve-slot cabinets. Twelve-slot cabinets are shown in these set up instructions.

CAUTION

Do NOT attempt to move the cabinet with the power modules or battery modules installed.

To set up 8- or 12- slot cabinets:

1. Move the UPS shipping pallet close to the desired location.
2. If installed, remove the straps and bracket bolts that attach the UPS to the pallet (see [Figure 7](#)).
3. If you are rack-mounting the UPS, proceed to "[2.6 Rack-Mount Installation](#)".

Figure 7. UPS on Shipping Pallet

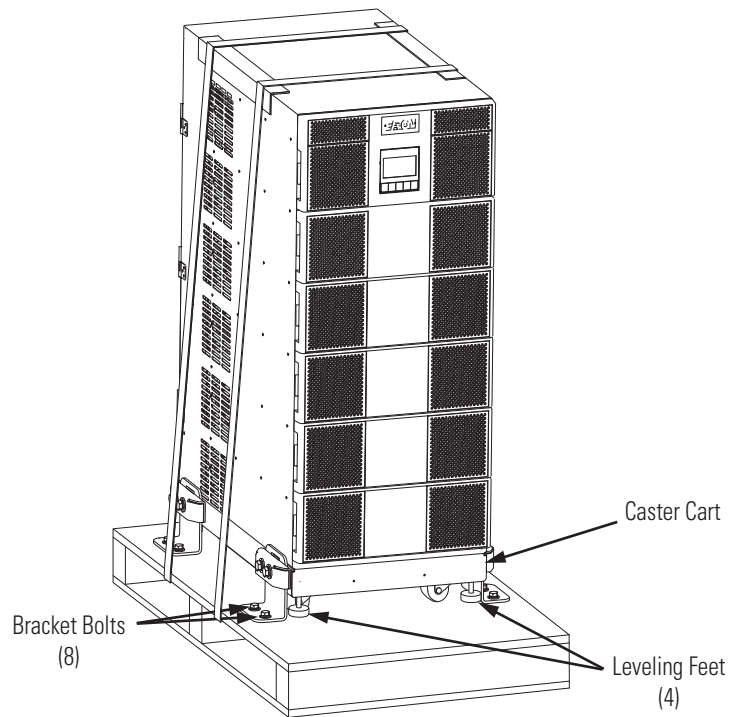

4. Attach the supplied ramp to the pallet with the two brackets and four wood screws provided. (See [Figure 8](#)).
5. Retract the leveling feet by turning them clockwise then carefully roll the cabinet down the ramp to its intended operating location (See [Figure 8](#)).

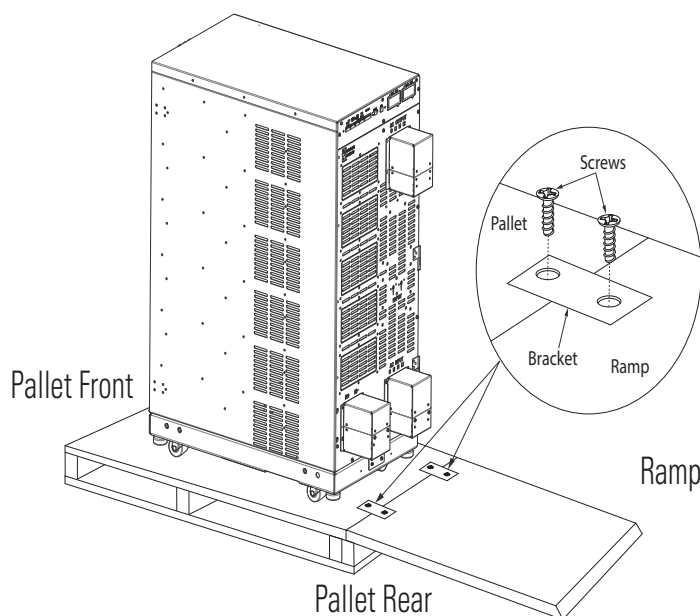
Figure 8. Moving the UPS from the Pallet**NOTE**

For ease of installation, determine if you have sufficient clearance at the rear of the UPS to complete the electrical connections before securing the UPS in its final position (see [3.1 Installation of the UPS with an External Bypass Switch](#) or [4.2 UPS Electrical Installation](#)).

6. Level the cabinet at its operating location by extending the four leveling feet.
7. If you are installing the floor anchors and they are not already installed, see "[2.5 Anchor Bracket Installation](#)" in the next section to install the floor anchor brackets.
8. If you are installing an external battery cabinet, continue to "[5.2 Standard Battery Cabinet Installation](#) or [5.1 Battery Cabinet Options](#)".
9. Continue to "[3.1 Installation of the UPS with an External Bypass Switch](#) or [4.2 UPS Electrical Installation](#)". as applicable.

2.5 Anchor Bracket Installation

**NOTE**

For ease of installation, complete the rear electrical connections before securing the anchor brackets to the floor. See or [4.2 UPS Electrical Installation](#).

The Eaton 9PXM UPS cabinet is shipped with four anchor (stabilizer) brackets (Kit P-157002300). These brackets must be attached to the floor. Under all module-loading conditions, they act as a protective stop to prevent the cabinet from falling forward if it is unintentionally pushed.

Each bracket has holes that enable it to be attached by screws to the floor (see [Figure 9](#)). The anchor brackets are attached to the cabinet base itself.

To install the stabilizer brackets:

Rack-Mount Installation

1. Select the location for the brackets at the floor intersection beside the intended cabinet location.
2. Attach the brackets to the cabinet base as shown in [Figure 9](#).
3. Roll the UPS cabinet to its intended location. Position the rear section of the cabinet base under the open ends of the stabilizer brackets as far as the cabinet will go.
4. Turn all four leveling feet counter-clockwise until the cabinet is level.
5. Using the proper type of customer-supplied screws for the intended mounting surface, attach each bracket as shown in [Figure 9](#). All screws must be properly driven into the structural material.

Figure 9. Floor Anchor Bracket Installation

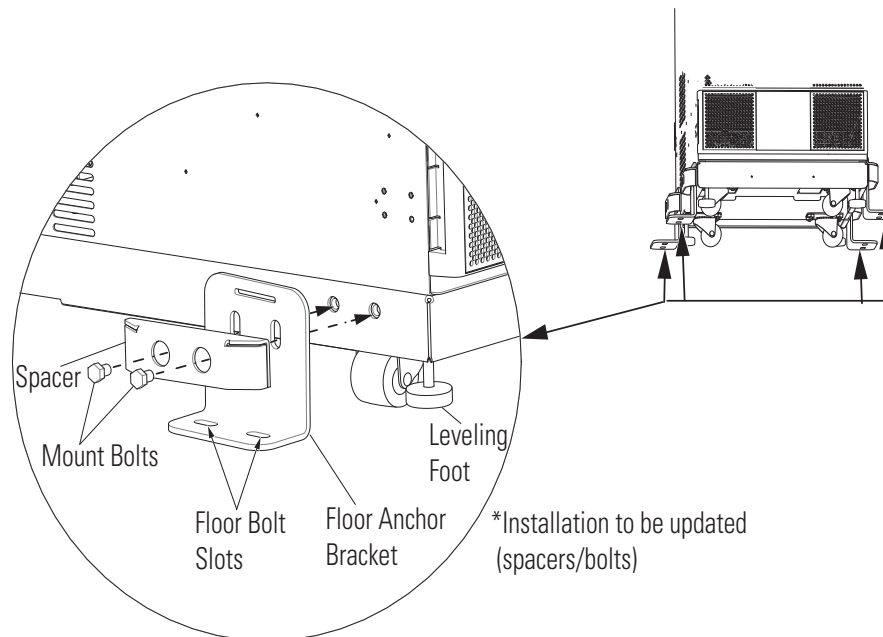

2.6 Rack-Mount Installation

CAUTION

The 12-slot UPS weighs 93 kg (204 lb) with the caster cart. Install the cabinet in the rack before installing power and battery modules and before making connections to the intended power source.

The Eaton 9PXM UPS and the battery cabinet are very heavy with power modules and two battery modules per slot installed. If installed, before moving the cabinets, remove the power modules and battery two battery modules per slot (see "[9.1 Routine Maintenance](#) ").

NOTE 1 The UPS cabinets may be installed in an EIA-standard 48.3 cm (19") equipment rack. An optional rack-mounting kit (P-157002204), containing brackets and required hardware, is available.



NOTE 2 This procedure is also applicable to the P-103002494 12-slot external battery module (EBM).

Use the following mounting procedures to install the UPS cabinet into the equipment rack:

1. Install rack-mount ears (two per side) on each side of the UPS cabinet (See [Figure 10](#)).

Figure 10. Rack-Mount Ear installation

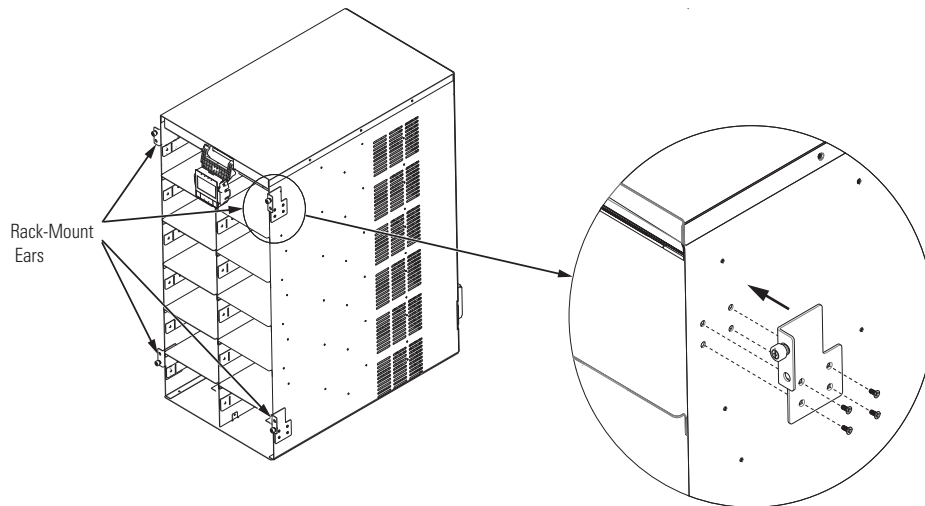

2. Select the proper holes in the front vertical rack rails that position the rack tray at the bottom in the rack and extend the back rails to align with the rear holes. Secure with the screws and washers (see [Figure 11](#)).

Figure 11. Rack Tray Location

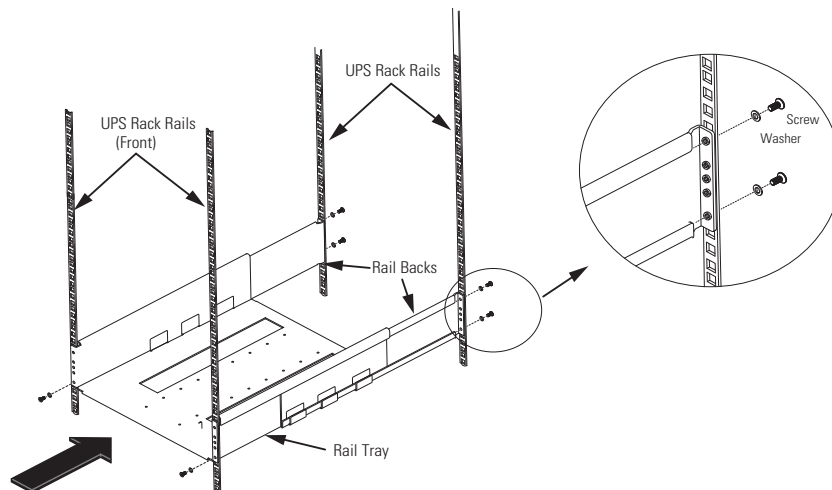

3. Remove the cabinet from the castor cart as follows (see [Figure 12](#)).
 - a. Lower the leveling feet to stabilize the castor cart.
 - b. Remove the rear bracket and screws.
 - c. Using two people, slide the cabinet backwards to disengage it from the slot tabs.

Figure 12. Remove Cabinet from Castor Tray

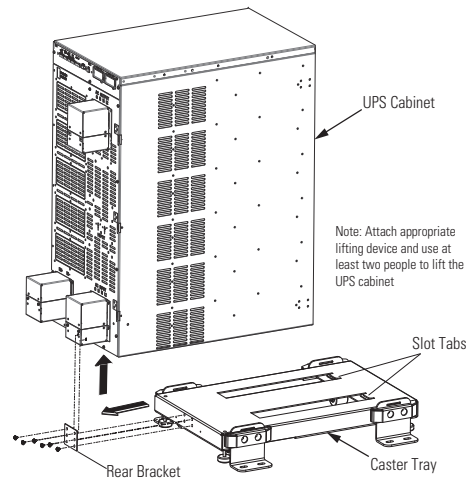

4. Carefully slide the UPS from the castor tray onto the rail tray in the equipment rack until the rack-mount ears of the cabinet are almost flush with the front vertical rails of the rack. Install metal clip nuts in the rack in line with the upper mounting brackets. Install the provided screws.
5. Install the provided screws into the lower rack mount ears to the threaded holes in the rail tray.

Figure 13. Securing the UPS in the Rack

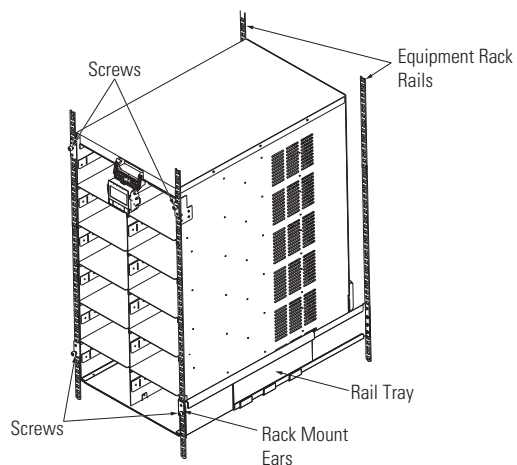

6. If you are installing an optional EBM cabinet refer to, "[5.2 Standard Battery Cabinet Installation](#)" or "[5.1 Battery Cabinet Options](#)".

Chapter 3 UPS With External Bypass Installation

3.1 Installation of the UPS with an External Bypass Switch

The Eaton 9PXM UPS input power is hardwired through a conduit to either a main power source circuit breaker or to an optional bypass switch. It is recommended that you install an Eaton® Bypass Power Module (BPM) to enable power transfer during maintenance or UPS downtime.

⚠ WARNING

Risk of electrical shock. Only qualified service personnel (such as a licensed electrician) should perform the electrical installation in this section.



NOTE

For installation and configuration of the Eaton bypass switch refer to the manual “Eaton Bypass Power Module (BPM) User’s Guide P-164000628” supplied with the switch or on the Eaton website <https://www.eaton.com/9PXM>.

If a bypass switch is used, both UPS input and UPS output must be hardwired through separate conduits to the bypass switch, as shown in [Figure 14](#).

Figure 14. Typical Installation with a Bypass Switch

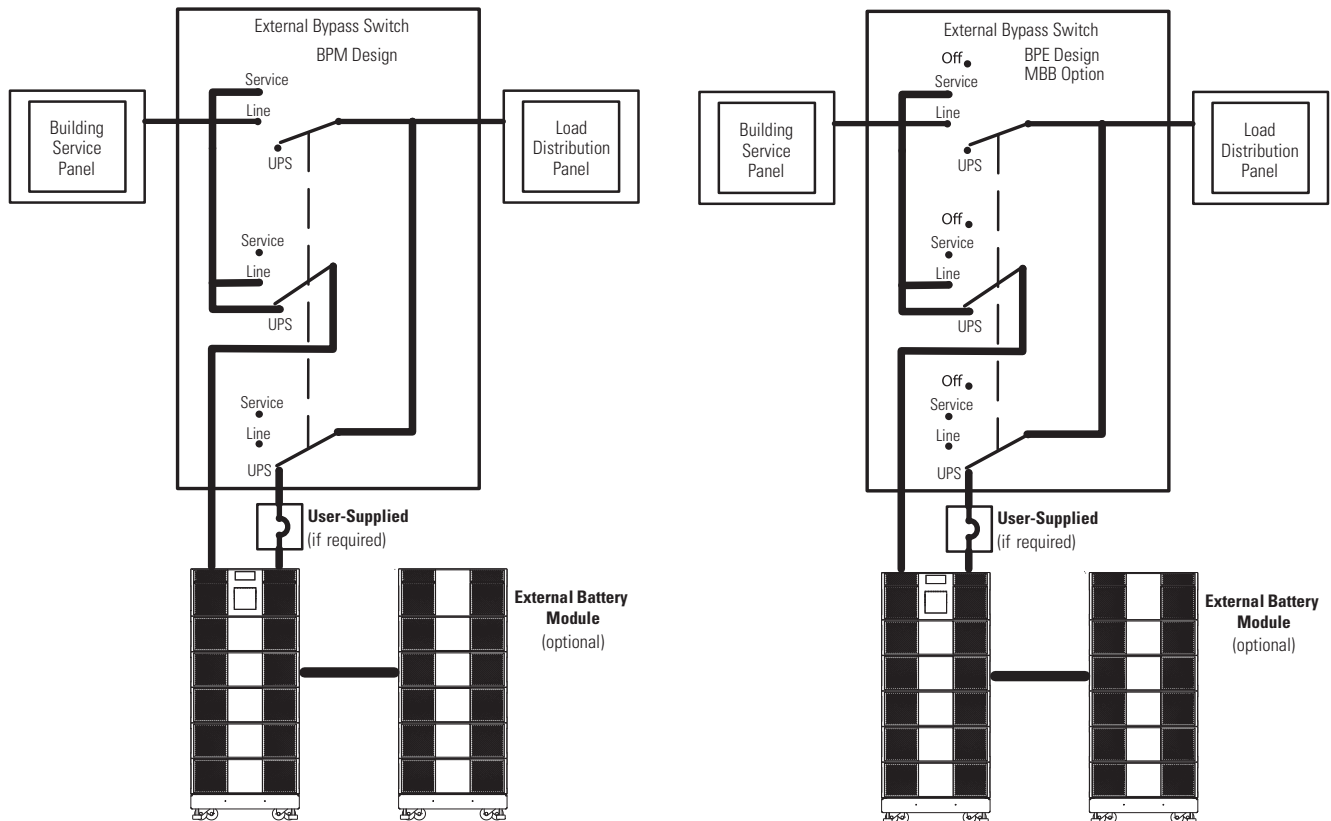

3.2 Circuit Breaker Input Ratings

Table 1. Recommended Breaker Sizes

UPS Capacity	Input Circuit breaker Rating	75°C Copper Wire Size
4kVA	25A	5.3 mm ² (10 AWG)
8kVA	50A	8.4 mm ² (8 AWG)
12kVA	80A	21.2 mm ² (4 AWG)
16kVA	100A	33.6 mm ² (2 AWG)
20kVA	125A	42.1 mm ² (1 AWG)

NOTE 1 If you are installing an optional super charger module in the UPS, then it is the same as a power module with the proper input circuit breaker sizes and ratings.



NOTE 2 To accommodate the feature of easy system expandability, it is recommended that initial installation of the Eaton 9PXM UPS contains wiring to support the maximum capacity of the UPS cabinet of 20kVA for 12-slot and 16-kVA for 8-slot cabinets.

NOTE 3 The 9PXM is limited to an input current of 125A. In the event an additional charging module has been employed in conjunction with the maximum allotted number of power modules, no additional input ampacity will be required.

See [Table 2](#) for recommended conductor sizes to wire the input circuit breakers.

Table 2. Recommended Wire Sizes

Input Breaker Size	75° Copper Wire Size	Conductor Screw Torque
25A	5.3 mm ² (10 AWG)	4.0 Nm (35 lb in)
50A	8.4 mm ² (8 AWG)	4.5 Nm (40 lb in)
80A	21.2 mm ² (4 AWG)	5.1 Nm (45 lb in)
100A	33.6 mm ² (2 AWG)	6.6 Nm (50 lb in)
125A	42.1 mm ² (1 AWG)	6.6 Nm (50 lb in)



IMPORTANT

- [Table 2](#) lists the mm² and AWG wire size for each circuit breaker size shown on the wiring diagrams. The minimum recommended circuit breaker sizes for each model and voltage application are listed on the wiring diagrams.
- Conductor sizes shall be no smaller than the 75°C wire size based on the ampacities given in Table 310.15 (B)(16) of the National Electrical Code® (NEC®), ANSI/NFPA 70-2017, and article 220. All circuit conductors, including the neutral conductor, must be the same size (ampacity) wire. Code may require a larger AWG size than shown in this table because of temperature, number of conductors in the conduit, or long service runs. Follow local code requirements.

3.3 UPS Connections

NOTE

For installation and configuration of the Eaton bypass switch refer to the manual "Eaton Bypass Power Module (BPM) User's Guide P-164000628" supplied with the switch or on the Eaton website.

UPS Connections

NOTE 1

Refer to "[3.2 Circuit Breaker Input Ratings](#)" for breaker, terminal block, and wire sizing.

NOTE 2

Connection Diagrams can be found on [Figure 17](#) and on [Figure 18](#).

CAUTION

To prevent electrical shock or damage to the equipment, verify that the Eaton 9PXM UPS is OFF before you remove the terminal covers. The circuit breaker or disconnect switch must also be OFF at the AC input service panel.

To install the UPS with an external bypass switch:

1. Mount the bypass switch within sight of the UPS. If you do not have an Eaton bypass switch or the fuse box or panel is out of sight, you must install a separate disconnect switch next to the UPS.
2. The bypass switch should be mounted securely to a sturdy surface. You may need to turn the cabinet 90 degrees (on its side) to enable operator access to the switch handle.
3. Remove the six screws on the bypass switch wiring cover and remove the cover. Remove any packing material inside the bypass switch.
4. Remove the knockouts in the bottom of the BPM as needed for wiring. See [Figure 15](#)

Figure 15. BPM Bypass Bottom

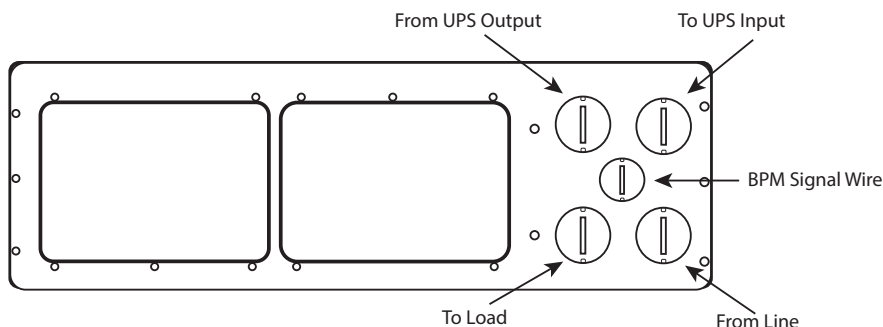
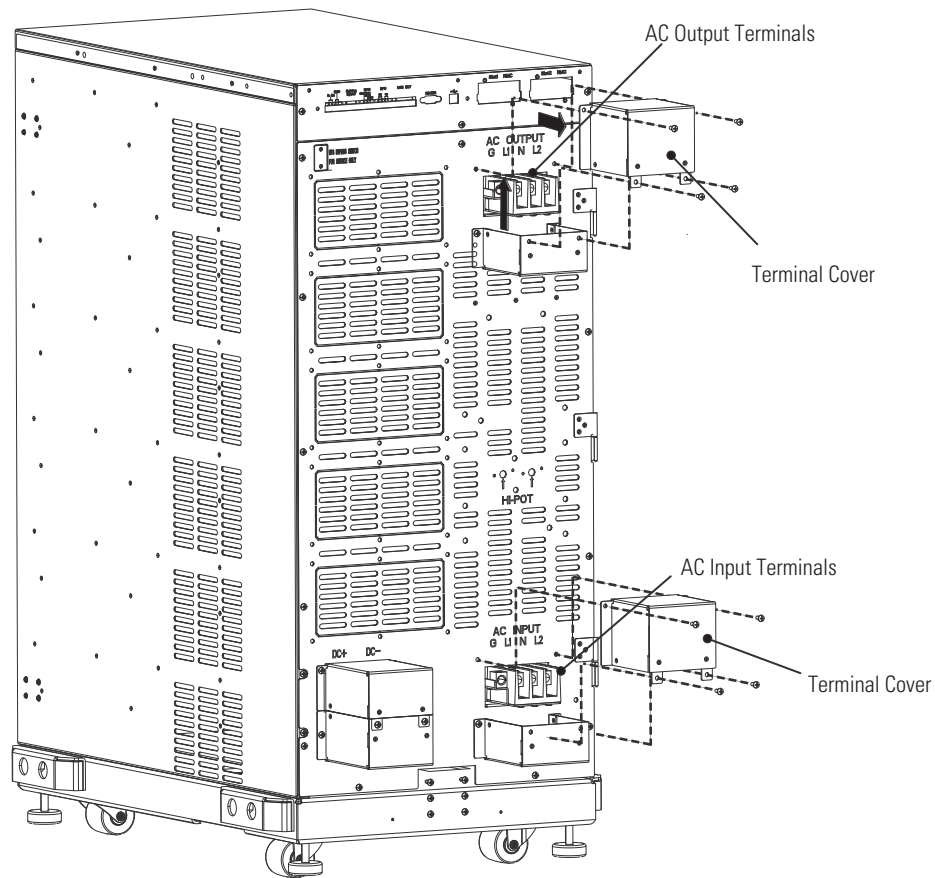
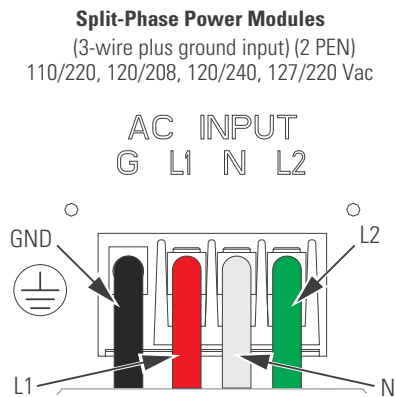

Figure 16. UPS AC Power Terminal Access

5. At the AC Input terminal, make sure to wire the UPS for the proper input voltage as shown in [Figure 17](#). Split-phase power modules provide a 2-phase output which can be configured as output voltages: 110/110 for 220, 120/120 for 240, 120/120 for 208, or 127/127 for 220 Vac, as selected through the front panel display.

Figure 17. Split-Phase Power Modules**NOTE**

UPS output circuits must be installed in separate conduit systems and not shared with other electrical circuits.

6. Make the UPS input and output connections to the terminal blocks on the rear panel (see [Figure 18](#)):
 - a. Insert the L1, N and L2 cable ends into the applicable terminal slots on the terminal block.
 - b. Insert the G (GND) cable end into the ground lug on the rear panel.
 - c. Secure the cables by screwing down the lug screws.
 - d. Torque the screws holding all input and output power conductors to the values specified in .
 - e. Reinstall the AC and DC terminal covers.
-

CAUTION

To reduce the possibility of electric shock all AC and DC terminal covers must be installed on the back of the UPS prior to any battery or power modules being inserted into the UPS.

Figure 18. UPS Input and Output Terminals

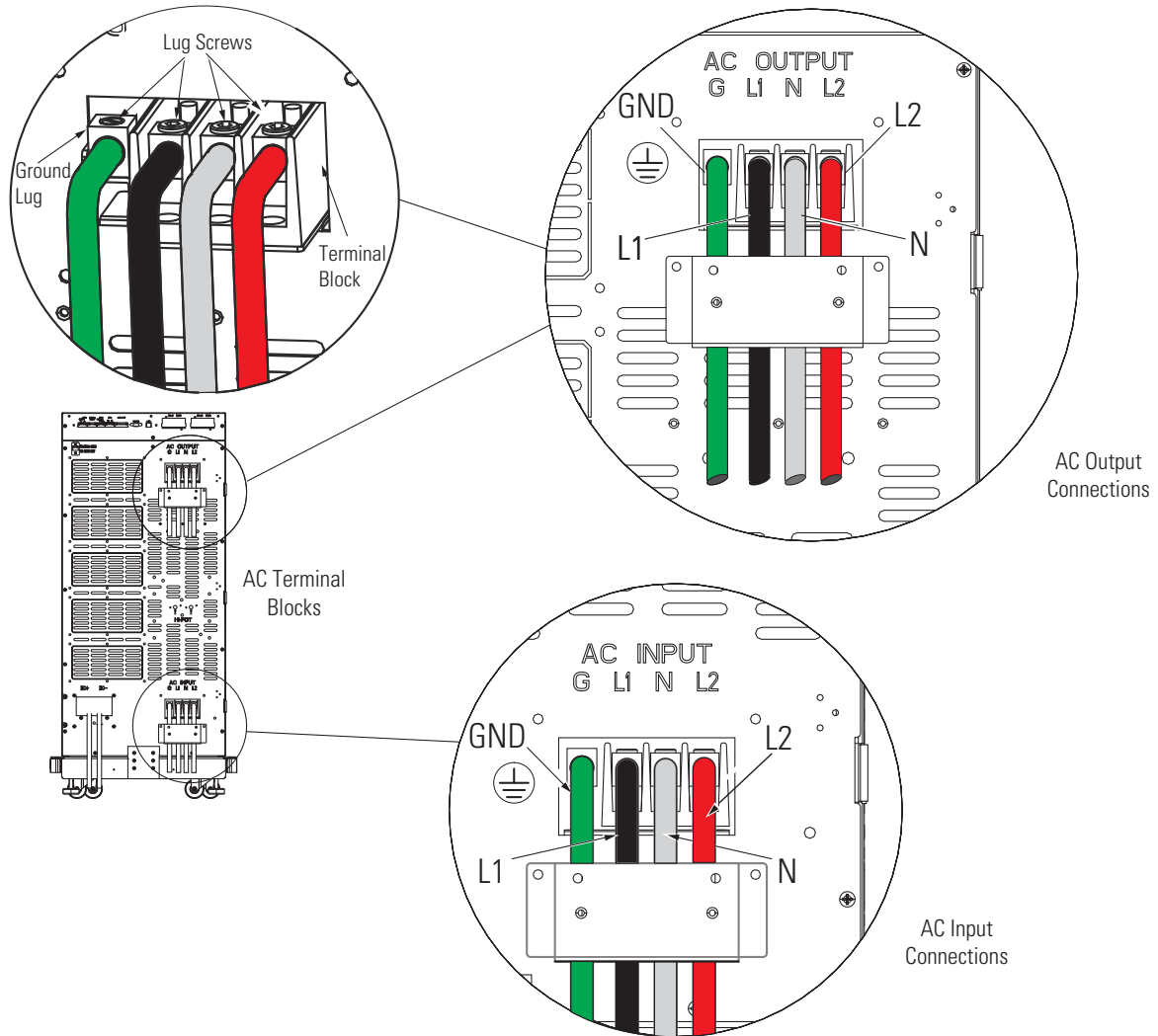

7. Route the power cables to the BPM and install conduit adapters to the BPM bottom plate.
8. Use the label on the top of the BPM access cover and [Figure 19](#), and make the connections to the BPM terminal blocks. Tighten all connections as specified in . Use copper wire that is the appropriate size for the current draw.

Figure 19. Bypass Switch Wiring Label and Terminal Blocks

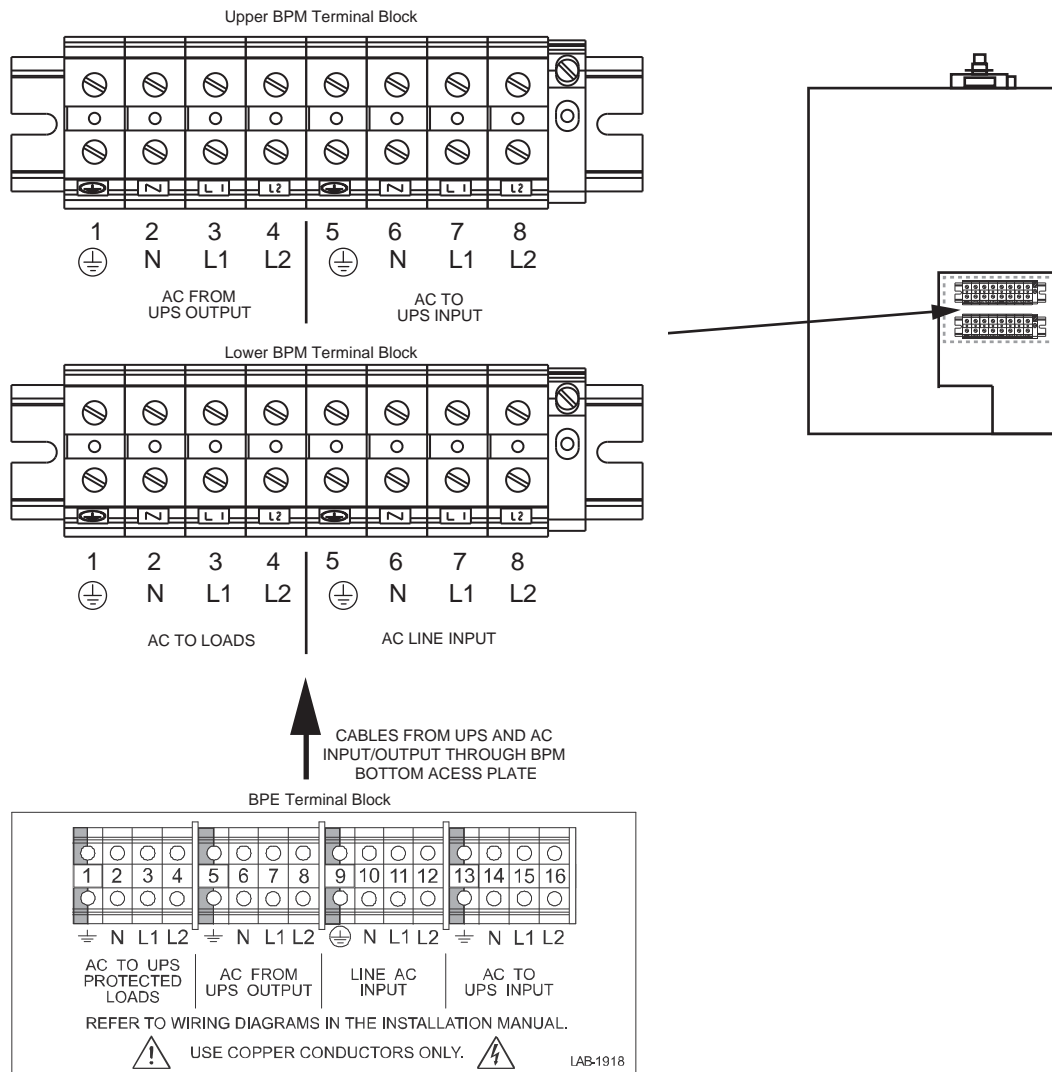

- After installing bypass switch wiring, torque the screws holding all input and output power conductors to the values specified.

3.4 BPM Signal Input Wire Routing



The auxiliary contacts must be wired to the BPM from the UPS for proper functionality. These auxiliary contacts signal the UPS to go to Internal Bypass mode to provide a synchronized transfer. Failure to wire the auxiliary contacts can be dangerous and result in system failure.

If the UPS is in standby mode and the bypass auxiliary contact is activated, the UPS output will become energized.

1. Route the maintenance bypass signal wires in a conduit from the bypass module to the communication signal terminal (CN13) on the rear of the UPS (See [Figure 20](#)). For conduit requirements consult your local electrical code.
2. Place the signal wires through the proper conduit or grommet to the terminal block in the BPM.

Figure 20. UPS Input Control Signal Wiring for Maintenance Bypass

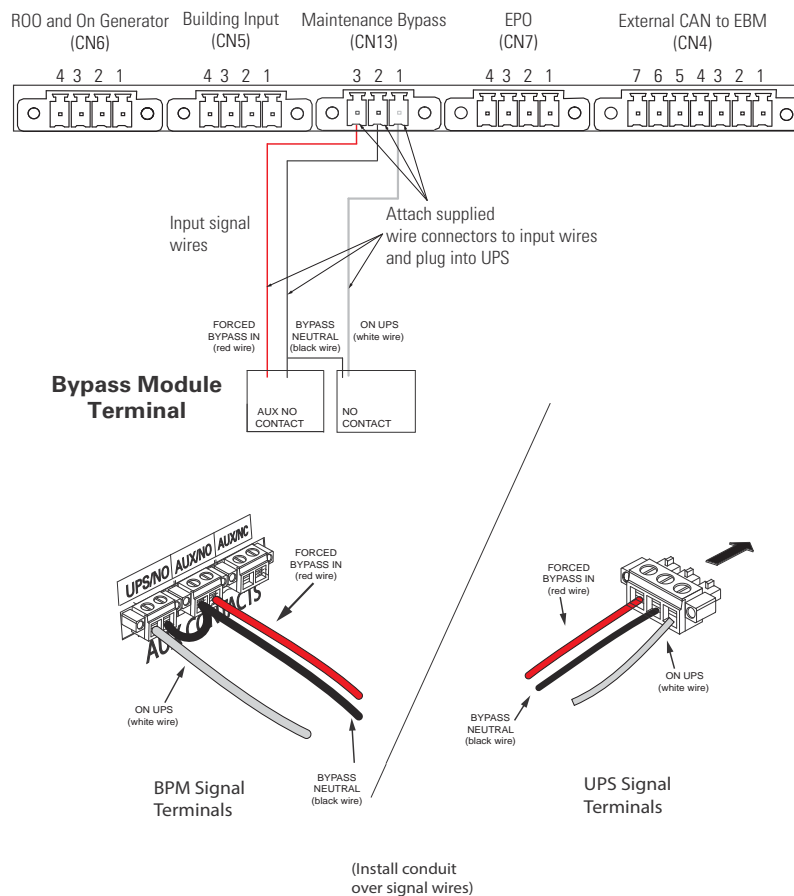

NOTE Do not strain relieve EPO or external bypass wiring with the same cable tie used for Generator “On” wires.

CAUTION

EPO and external bypass circuits are safety extra low voltage circuit. This circuit must be isolated from any hazardous voltage circuits by reinforced insulation.

- 3. Attach the supplied cable connectors to the ends of the input wires.
- 4. For BPE connections as shown in :
 - a. Connect up the 4 wires from the BPE to the 9PXM per the attached drawing and using the 3 pin connector (see [Figure 21](#)).

Figure 21. BPE to UPS Connector

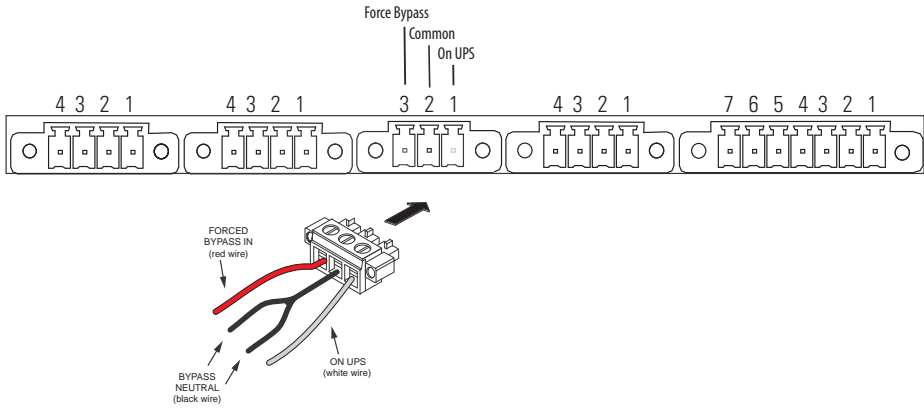

- b. Install the 3 pin connector into the 9PXM UPS BPM CN13 connector (see [Figure 22](#)).

Figure 22. Three-Pin BPM to UPS Connector

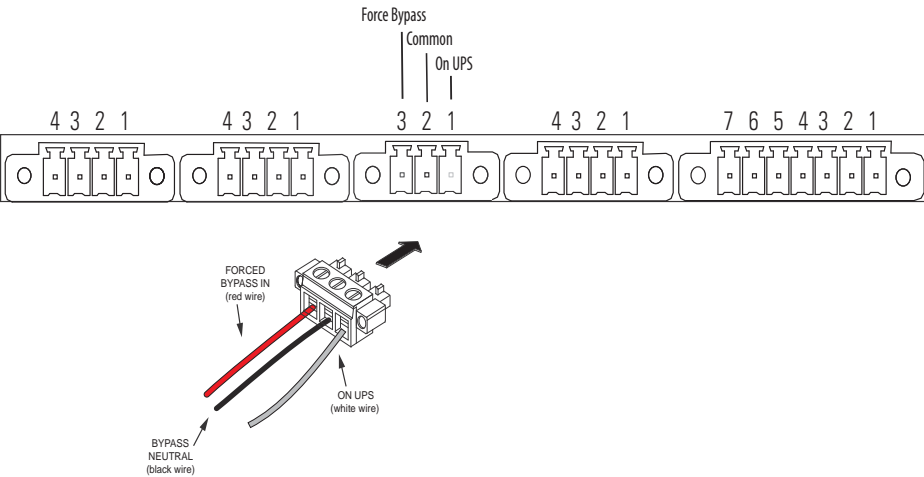

NOTE Make a note to enable Forced and Maintenance Bypass per the following step when installation is complete and power available.

- c. Navigate the 9PXM LCD to the forced and maintain bypass settings Input signals menu in the 9PXM user guide (see [Figure 23](#)).
- d. Set both Forced Bypass and Maintain Bypass settings to Enabled and Normally open (see [Figure 23](#)).

Figure 23. Forced and Maintenance Bypass Screens

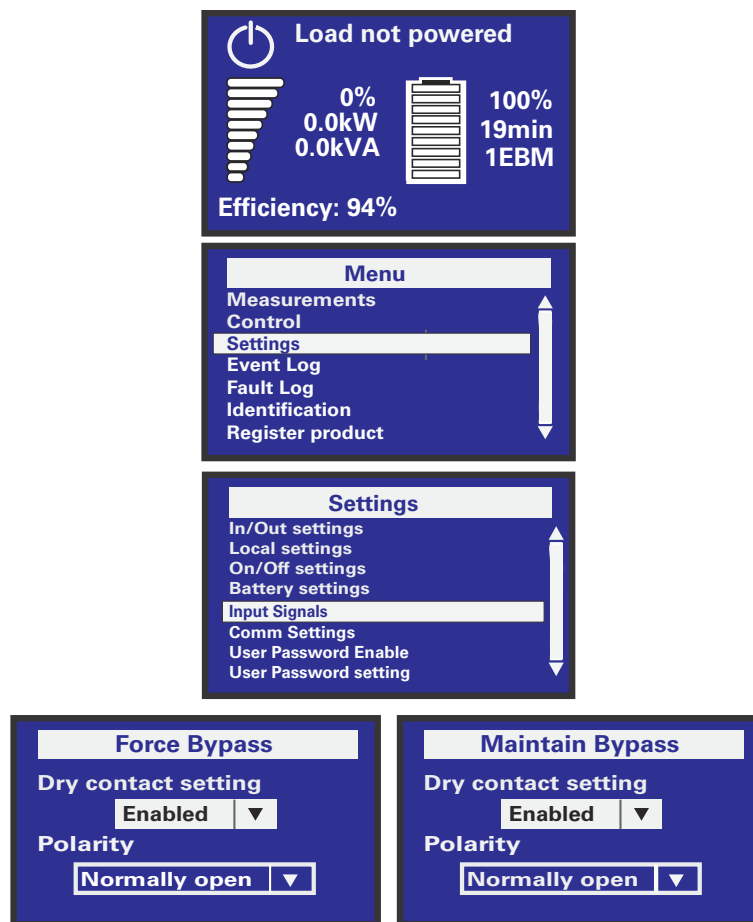

5. Install the supplied wiring connectors to the UPS input control signal wires and connect to the terminals as shown in or .
6. When all connections have been made and checked, reinstall the bypass switch front cover using the original screws.
7. If floor anchor brackets were installed and not secured, install the floor bolts.

8. After electrical installation is complete, you must also set the output settings menu for the required output voltage as shown in the wiring configuration drawings (See [3.5 System Wiring Diagrams](#)).

3.5 System Wiring Diagrams

System Wiring Diagram

Refer to the system wiring diagram for correct installation. The following notes are referenced by their number in the UPS with external bypass wiring diagram (see [Figure 24](#) and [Figure 25](#)).

-
- NOTE 1** **The customer must provide input overcurrent protection.** See NEC Section 240-21 or local requirements. See [3.2 Circuit Breaker Input Ratings](#) for circuit breaker ratings to size the protection device according to local code requirements.
- NOTE 2** The UPS bypass switch must be installed within sight of the UPS. To properly install, complete the voltage and phase check procedure in "[6.1 UPS Startup](#)". The wires coming from the side of the switch must be connected as described in .
- NOTE 3** **The customer must size the AC circuit conductors.** All AC circuit conductors, including the neutral conductor, must be the same size (ampacity), have the same rating (75°C) copper wire, and be sized according to the input circuit breaker. See [Table 2](#) . The UPS input and output conductors must be run through separate conduits.
-  **NOTE 4** **The customer must provide output overcurrent protection.** See NEC Section 240-21 or local requirements. See [Table 1](#) for maximum output overcurrent protection device ratings.
- NOTE 5** See "[2.1 Preparing for Installation](#)" for installation and service clearances before installing the UPS. Use flexible conduit on the UPS or the external battery cabinet if either must be moved.
- NOTE 6** External UPS battery cabinets are optional. See "[5.2 Standard Battery Cabinet Installation](#)" or [5.1 Battery Cabinet Options](#)" for installation instructions.
- NOTE 7** UPS output circuits shall be installed in dedicated conduit systems and not shared with other electrical circuits.
- NOTE 8** Use only Eaton-supplied power cables between the UPS and EBM(s) (PN:P-103003231).
- NOTE 9** CN3 and CN4 CAN cables ground separately to each cabinet chassis.
-

Figure 24. Wiring Diagram- UPS with External Bypass Switch (BPM) (L1, L2, N)

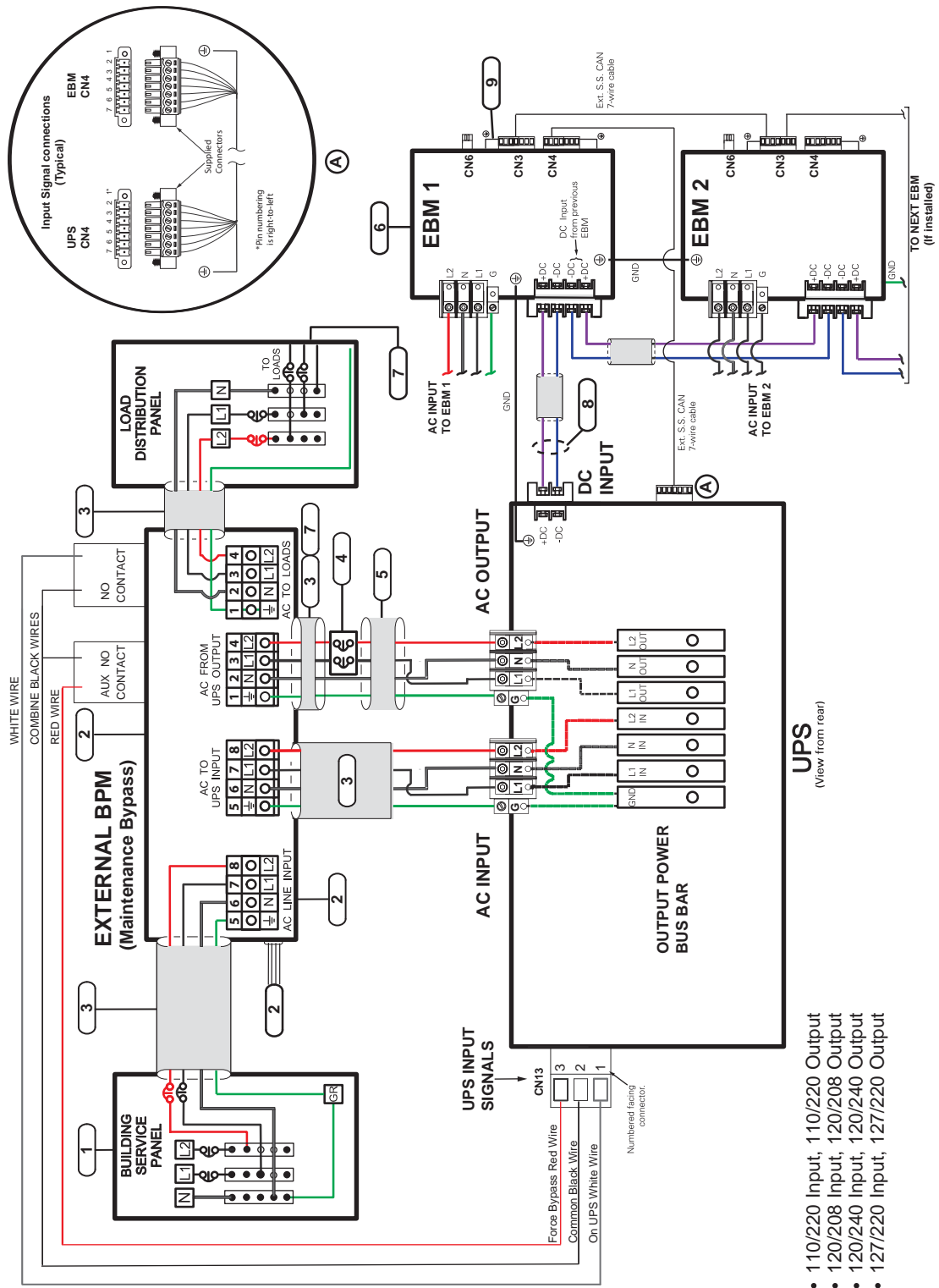
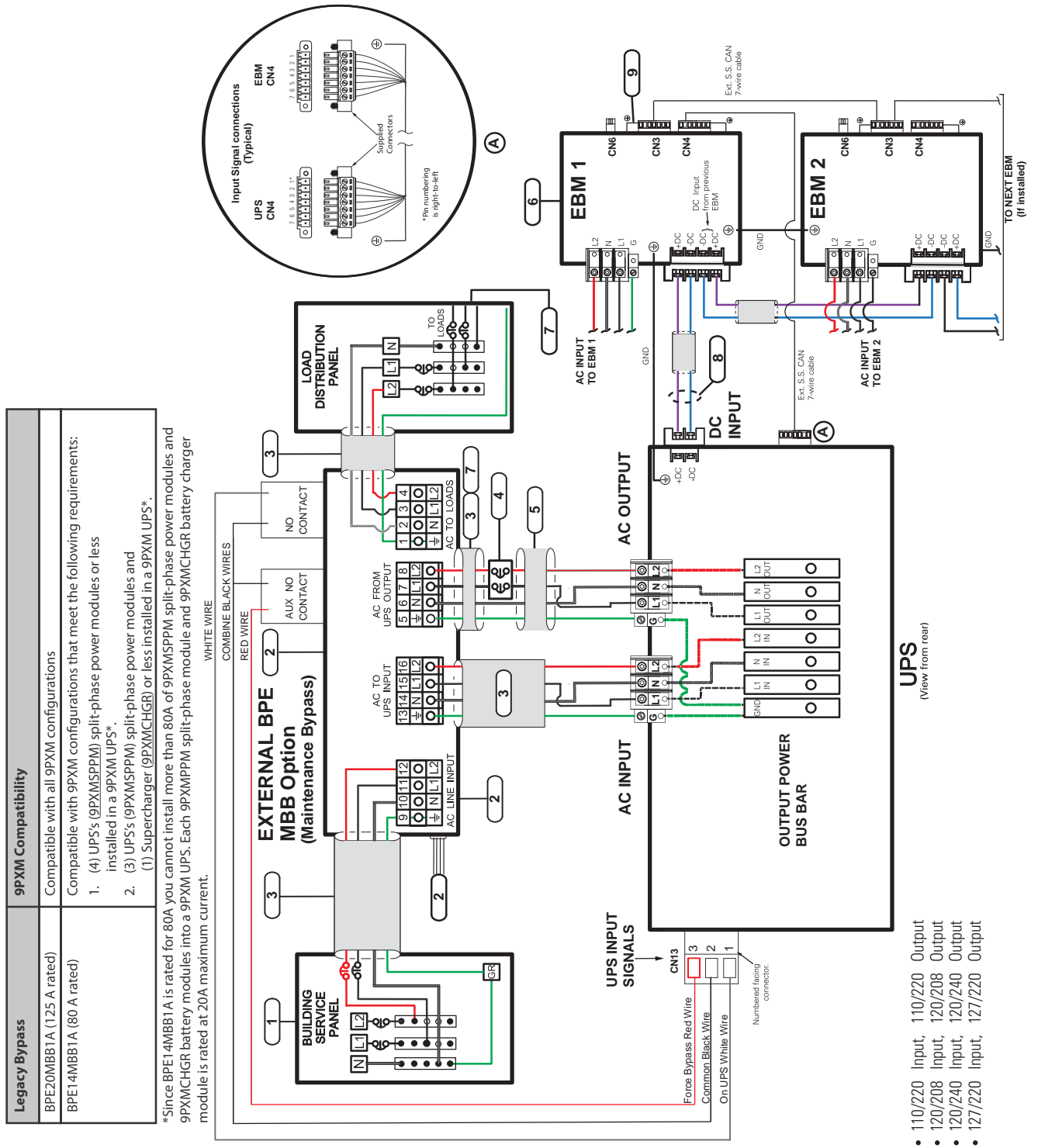

Figure 25. Wiring Diagram- UPS with External Bypass Switch (BPE) (L1, L2, N)



3.6 Bypass Overview

The BPM has three operating positions (see [Table 3](#)). Consider both the operating state of the UPS and the BPM when protecting your critical loads.

WARNING

Failure to understand the correct bypass sequence and position may cause the critical load to be dropped. Damage to the power modules or the Bypass switch can occur.

- If the UPS remains in Bypass Mode and incoming AC power is lost, the load is automatically dropped. The UPS must be in Normal Mode to provide battery backup power.
 - In the UPS or LINE position, AC input power is still connected to the input terminals inside the UPS.
 - **If the UPS is in the standby mode and the bypass switch is in the LINE or UPS positions pressing the red bypass switch interlock button will energize the UPS output.**
 - **Do not attempt to push the red interlock button or attempt to move the bypass switch handle if the UPS is operating on battery power.**
 - If you have any questions or problems with the bypass operation, call the Help Desk (see , “[11.2 Service and Support](#)”).
-

The BPM consists of a load position handle and a red button (see [Figure 26](#)).

Figure 26. Bypass Switch Positions

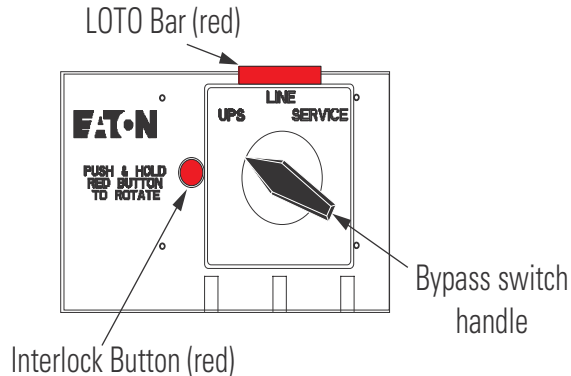

The red button:

- Sends an electrical signal to the UPS to switch to the Bypass Mode (if it is not already operating in that mode).
- Operates a mechanical interlock, to prevent the switch from being turned without first signaling the UPS.

You must press the red button before you can turn the load position handle.

When the red button is pressed, the UPS front panel displays “Bypass Mode.” To move the MBP switch handle from one position to another, the red button must be pressed WHILE the handle is being rotated. Otherwise, the switch will be damaged.

The bypass switch has three positions as described in [Table 3](#).

**NOTE**

In the UPS or LINE position, AC input power is still connected to the input terminals inside the UPS.

Table 3. Bypass Switch Positions

Switch Position	Description
LINE	When the switch is in the LINE position, utility power is directly connected to the critical load and the output of the UPS is disconnected. In this state the UPS remains powered, which is often beneficial for troubleshooting, obtaining logs, or updating firmware.
UPS	The normal operating state of the system occurs when the BPM switch is in the UPS position. Utility power is fed to the bypass, where power is then fed to the UPS. The UPS provides critical battery backup and power conditioning and power is then fed back to the bypass switch and then the critical load.
Service	Like the LINE position, the SERVICE position connects the load directly to AC input power and disconnects UPS output; however, because SERVICE also disconnects AC input from the UPS, this is the appropriate position for UPS maintenance or repair. In the SERVICE position, the UPS can be completely removed from the system.

3.7 No Break Transfer from UPS Mode to Service Mode



Failure to understand the correct bypass sequence and position may cause the critical load to be dropped. Damage to the power modules or the Bypass switch can occur.

- If the UPS remains in Bypass Mode and incoming AC power is lost, the load is automatically dropped. The UPS must be in Normal Mode to provide battery backup power.
- In the UPS or LINE position, AC input power is still connected to the input terminals inside the UPS.
- **If the UPS is in the standby mode and the bypass switch is in the LINE or UPS positions pressing the red bypass switch interlock button will energize the UPS output.**
- **Do not attempt to push the red interlock button or attempt to move the bypass switch handle if the UPS is operating on battery power.**
- If you have any questions or problems with the bypass operation, call the Help Desk (see , “[11.2 Service and Support](#)”).

To turn the BPM to SERVICE:

1. Press and hold the red button and turn the switch to LINE (see [Figure 27](#)).

**NOTE**

Pressing the red button sends the UPS into Bypass Mode. This allows the UPS output to synchronize with utility for safe, uninterrupted transfer.

The UPS is now in LINE mode. The critical load is fed directly from utility and the UPS remains energized from utility power. The UPS may be left in this mode while trying to troubleshoot, gather alarms from the UPS, or perform other preventative maintenance activities.

Figure 27. Bypass From UPS to LINE

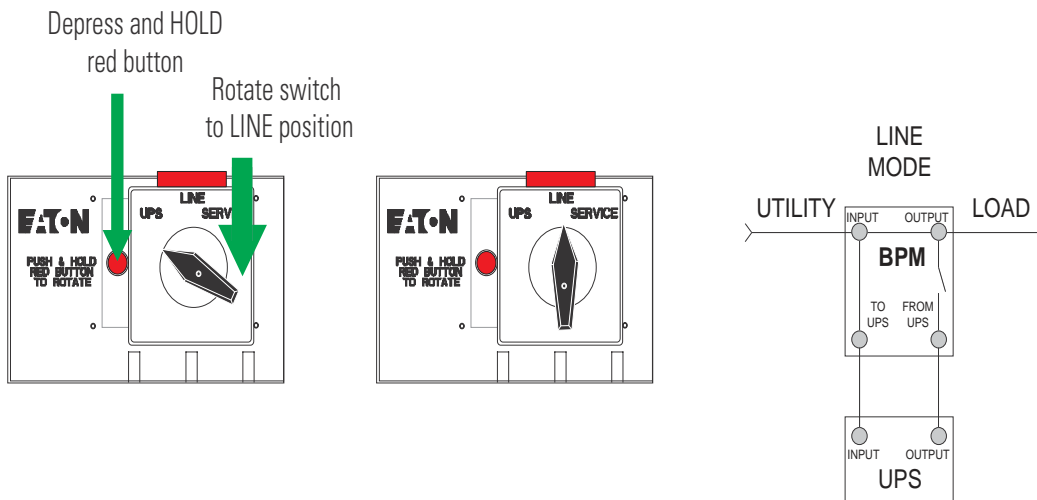

2. Turn the switch from LINE to SERVICE (see [Figure 28](#)). The critical load is fed directly from utility and the UPS is now completely disconnected from AC power. Ensure that the UPS is off and the terminals are completely de-energized before performing any maintenance on the UPS.

Figure 28. Bypass From LINE to SERVICE

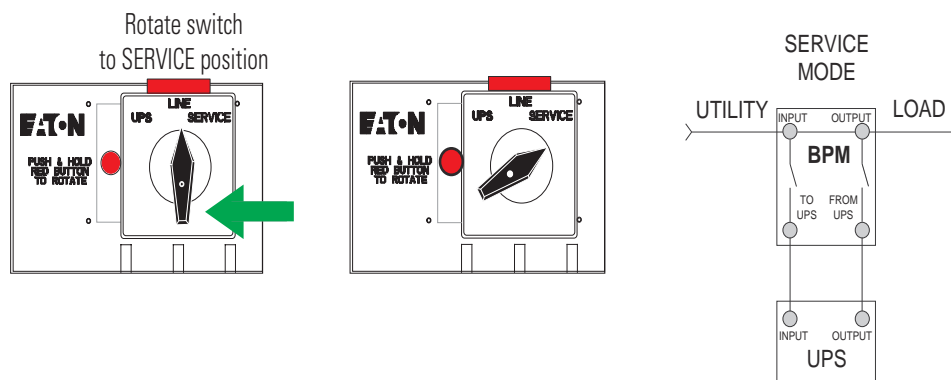

3.8 Lock-out/Tag-out

The BPM comes with a Lock-out/Tag-out (LOTO) feature to keep the BPM bypass switch locked in SERVICE mode while qualified service personnel works on the UPS. To use the LOTO feature:

1. Press and hold the red bar (See [Figure 29](#)).

Figure 29. LOTO Feature

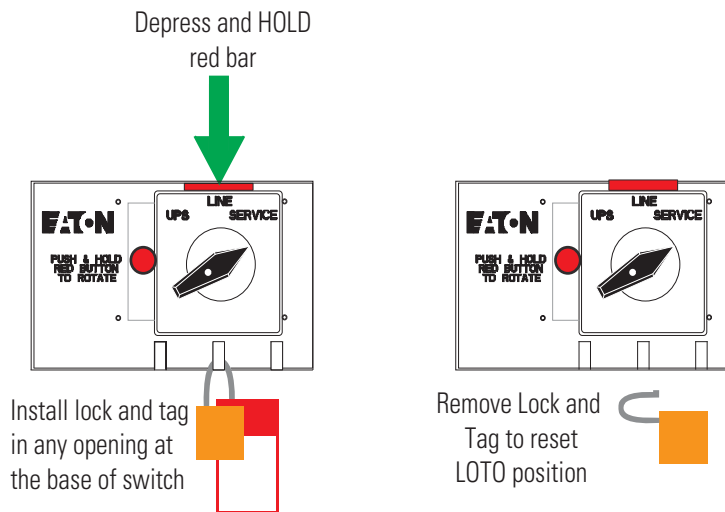

2. Install a lock and tag in any opening at the base of the switch according to LOTO procedures.
3. Remove the lock and tag to reset the LOTO position.

3.9 No Break Transfer from Service Bypass to UPS Mode

After the system has been placed into SERVICE mode, it must be returned to UPS state to resume Normal operation.

⚠ WARNING

Failure to understand the correct bypass sequence and position may cause the critical load to be dropped. Damage to the power modules or the Bypass switch can occur.

- If the UPS remains in Bypass Mode and incoming AC power is lost, the load is automatically dropped. The UPS must be in Normal Mode to provide battery backup power.
 - In the UPS or LINE position, AC input power is still connected to the input terminals inside the UPS.
 - **If the UPS is in the standby mode and the bypass switch is in the LINE or UPS positions pressing the red bypass switch interlock button will energize the UPS output.**
 - **Do not attempt to push the red interlock button or attempt to move the bypass switch handle if the UPS is operating on battery power.**
 - If you have any questions or problems with the bypass operation, call the Help Desk (see , “ [11.2 Service and Support](#) ”).
-

To turn the BPM to UPS Mode:

1. Turn the switch from SERVICE to LINE (see [Figure 30](#)).

No Break Transfer from Service Bypass to UPS Mode

The UPS is now in LINE mode and is energized. It is often best practice to check the UPS status and configure settings in this mode before transitioning to UPS Mode. Simply check the status of the UPS through the front LCD menu to ensure the UPS is prepared for use.

Figure 30. From SERVICE to LINE

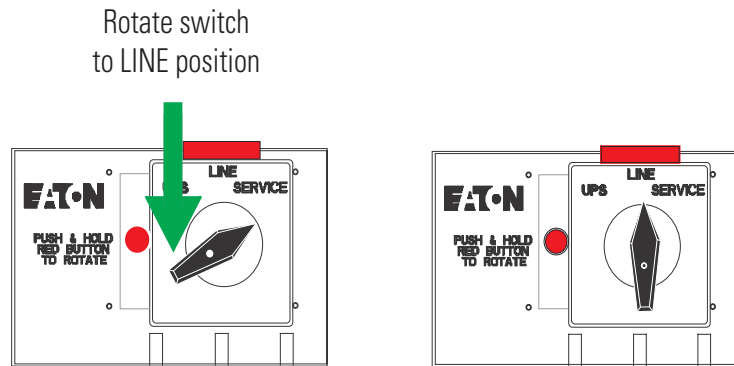

2. To transition the UPS from LINE to UPS, press and hold the red button and turn the switch to UPS (see [Figure 31](#)).

NOTE 1 Pressing the red button sends the UPS into Bypass Mode. This allows the UPS output to synchronize with utility for safe, uninterrupted transfer.



NOTE 2 In UPS Mode, the UPS resets from Bypass to UPS Normal Mode (Online Mode). This transition may take as long as 60 seconds.

Figure 31. From LINE to UPS

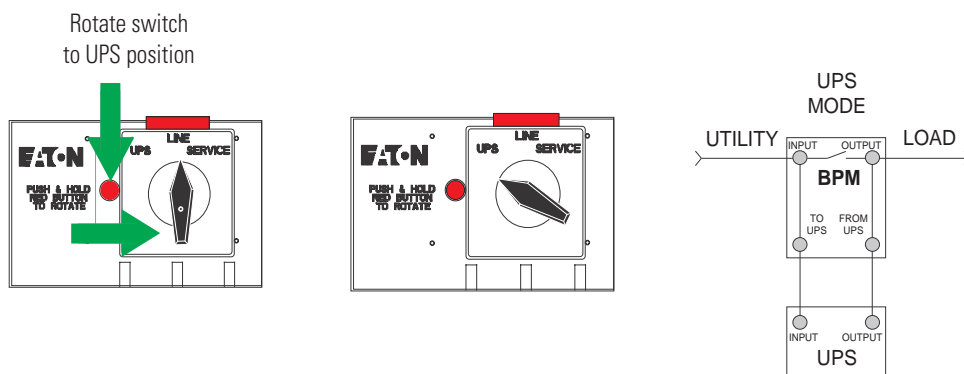

3. Once the switch is in UPS Mode and the UPS is in Normal Mode (Online Mode), the system is in Normal operation and prepared to provide uninterrupted power to the critical load.

After turning the load position handle to the UPS position and releasing the red button, if the Eaton 9PXM UPS remains in Bypass Mode, return the UPS to Normal Mode using the following procedure for proper operation:

NOTE 1 If the UPS remains in Bypass Mode and incoming AC power is lost, the load is automatically dropped. The UPS must be in Normal Mode to provide battery backup power.



NOTE 2 If you have any questions or problems with the bypass operation, call the Help Desk at one of the telephone numbers in [11.2 Service and Support](#) and ask for a UPS technical representative.

- Press ← the button on the front panel display. The main menu screen appears (see).
 - Press the ▼ button to select Control.
 - Press the ← button. Control menu displays.
 - Press the ← button to select Go back Normal.
 - Press the ▼ button to select Yes and press to return to Normal (UPS) Mode.
 - Press ESC twice to return to the Status Menu. The UPS is now in Normal mode.
-

NOTE 1 The UPS should transfer from Bypass Mode to Normal operation after a period of one minute automatically provided the Input signals are set correctly. See [Figure 23](#) .



NOTE 2 To disconnect AC input power during maintenance or service, turn the Bypass switch to the SERVICE position.

NOTE 3 [Table 4](#) shows the bypass switch models available for the Eaton 9PXM UPS.

Table 4. BPM Dimensions

Model	Height	Width	Depth	Weight
	(A)	(B)	(C)	
BPM125XX	130 mm 21.0"	440 mm (14.0")	663 mm (6.8")	17 kg (38 lb)

No Break Transfer from Service Bypass to UPS Mode

Chapter 4 UPS Electrical Installation

4.1 UPS Input Current Ratings

⚠ WARNING

Risk of electrical shock. Only qualified service personnel (such as a licensed electrician) should perform the electrical installation in this section.

If a bypass switch is not used, the UPS input may be hardwired through conduit to a main power source circuit breaker, and the UPS output may either be hardwired to a circuit breaker in a distribution panel (as shown in Figure 31) or supplied to loads through optional receptacles on the back of the UPS. Without a bypass switch, power to the load cannot be maintained if the UPS is taken completely offline.

Figure 32. Typical Installation without a Bypass Switch

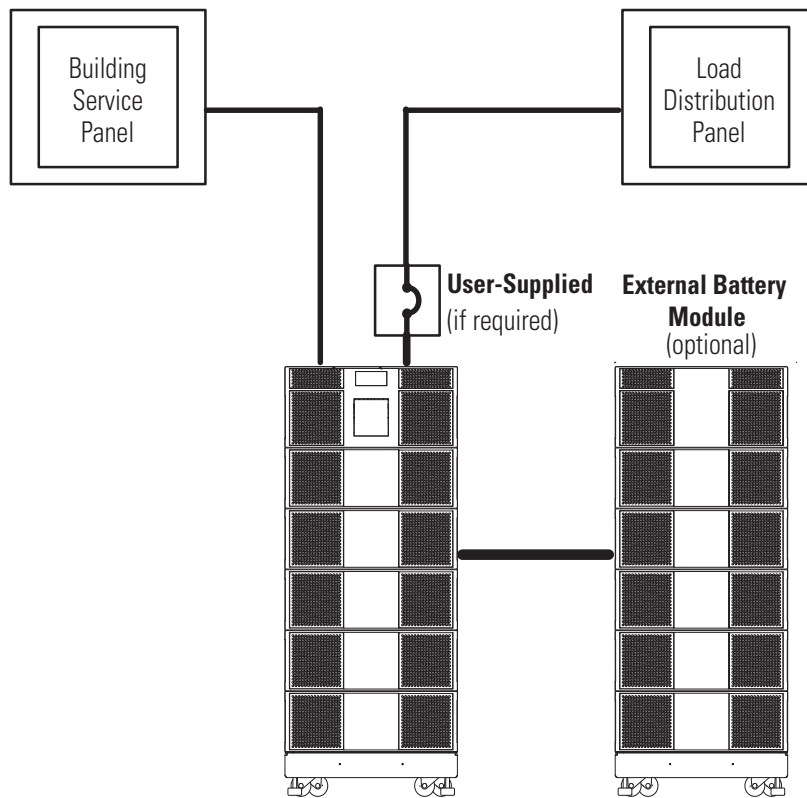

[Table 5](#) contains the required circuit breaker ratings for hardwired installations.

Table 5. UPS Recommended Breaker Sizes

UPS Capacity	Input Circuit breaker Rating	75°C Copper Wire Size
4kVA	25A	5.3 mm ² (10 AWG)
8kVA	50A	8.4 mm ² (8 AWG)
12kVA	80A	21.2 mm ² (4 AWG)
16kVA	100A	33.6 mm ² (2 AWG)
20kVA	125A	42.1 mm ² (1 AWG)



NOTE If a super charger is installed in an EBM, the circuit breaker for the AC input to EBM must be a 25 A breaker with 5.3 mm² (10 AWG) copper wire.



NOTE To accommodate the feature of easy system expendability, it is recommended that initial installation of the Eaton 9PXM UPS contains wiring to support the maximum capacity of the UPS cabinet : 20kVA for 12–slot cabinets and 16kVA for 8 slot chassis.

See for recommended conductor sizes to wire the input circuit breakers.

Table 6. UPS Recommended Wire Sizes

Input Breaker Size	75° Copper Wire Size	Conductor Screw Torque
25A	5.3 mm ² (10 AWG)	4.0 Nm (35 lb in)
50A	8.4 mm ² (8 AWG)	4.5 Nm (40 lb in)
80A	21.2 mm ² (4 AWG)	5.1 Nm (45 lb in)
100A	33.6 mm ² (2 AWG)	6.6 Nm (50 lb in)
125A	42.1 mm ² (1 AWG)	6.6 Nm (50 lb in)



IMPORTANT

FOR U.S. INSTALLATIONS, READ THIS IMPORTANT NOTE

- lists the mm² and AWG wire size for each circuit breaker size shown on the wiring diagrams. The minimum recommended circuit breaker sizes for each model and voltage application are listed on the wiring diagrams.
- Conductor sizes shall be no smaller than the 75°C wire size based on the ampacities given in Table 310.15 (B)(16) of the National Electrical Code® (NEC®), ANSI/NFPA 70-2017, and article 220. All circuit conductors, including the neutral conductor, must be the same size (ampacity) wire. Code may require a larger AWG size than shown in this table because of temperature, number of conductors in the conduit, or long service runs. Follow local code requirements.

4.2 UPS Electrical Installation



Only qualified service personnel (such as a licensed electrician) should perform the electrical installation. Risk of electrical shock.



To prevent electrical shock or damage to the equipment, verify that the Eaton 9PXM UPS is OFF before you remove the terminal covers. The circuit breaker or disconnect switch must also be OFF at the AC input service panel.

To install the UPS without an external bypass switch:

1. Install the AC terminal upper covers supplied in the accessory kit of the UPS (See [Figure 33](#)). The AC input terminal block is located on the lower right side and the AC output on the upper right side of the UPS rear panel.

Figure 33. UPS Power Terminals

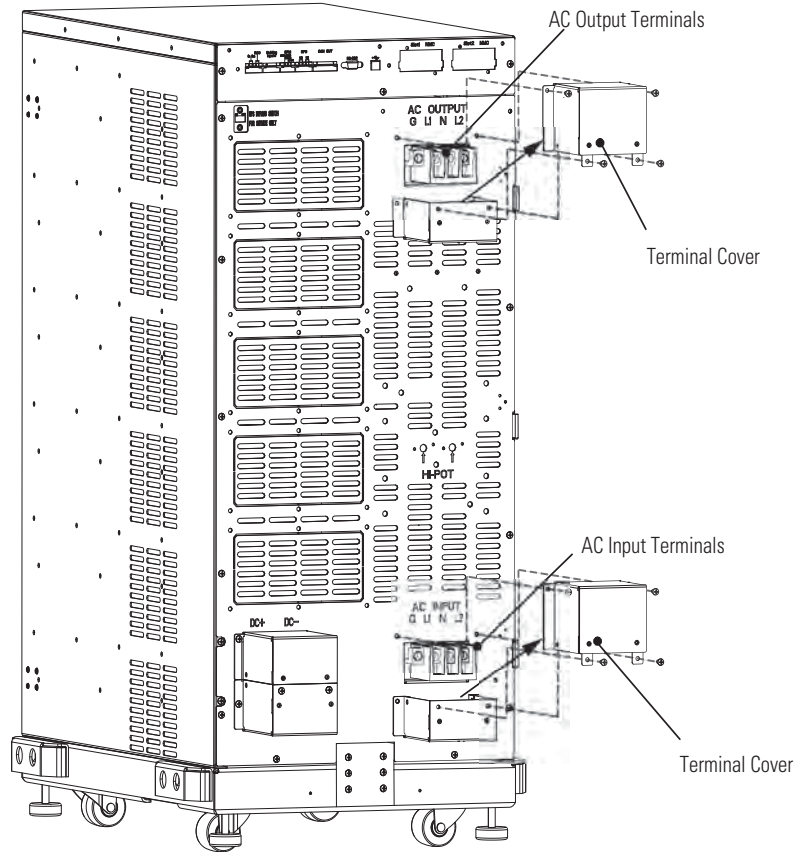

2. At the AC Input terminal, make sure to wire the UPS for the proper input voltage as shown in [Figure 34](#) . Split-phase power modules provide a 2-phase output which can be configured as output voltages: 110/110 for 220, 120/120 for 240, 120/120 for 208, or 127/127 for 220 Vac, as selected through the front panel display (“[7.15 Display Menu Screens](#)”).

Figure 34. Split-Phase Power Modules

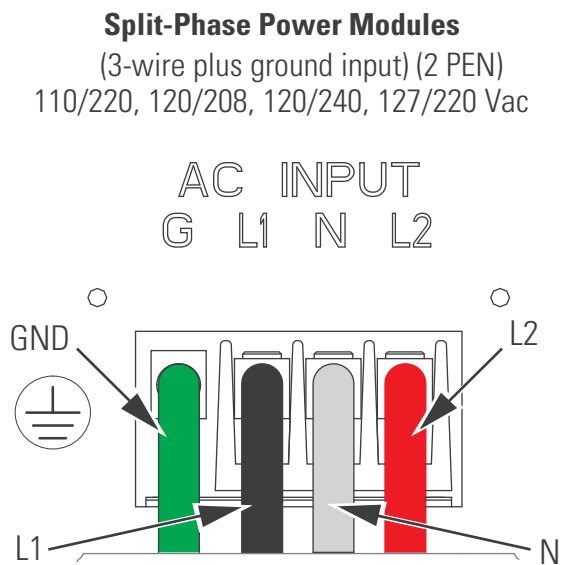

**NOTE**

UPS output circuits must be installed in separate conduit systems and not shared with other electrical circuits.

Figure 35. UPS Input and Output Terminal Connections

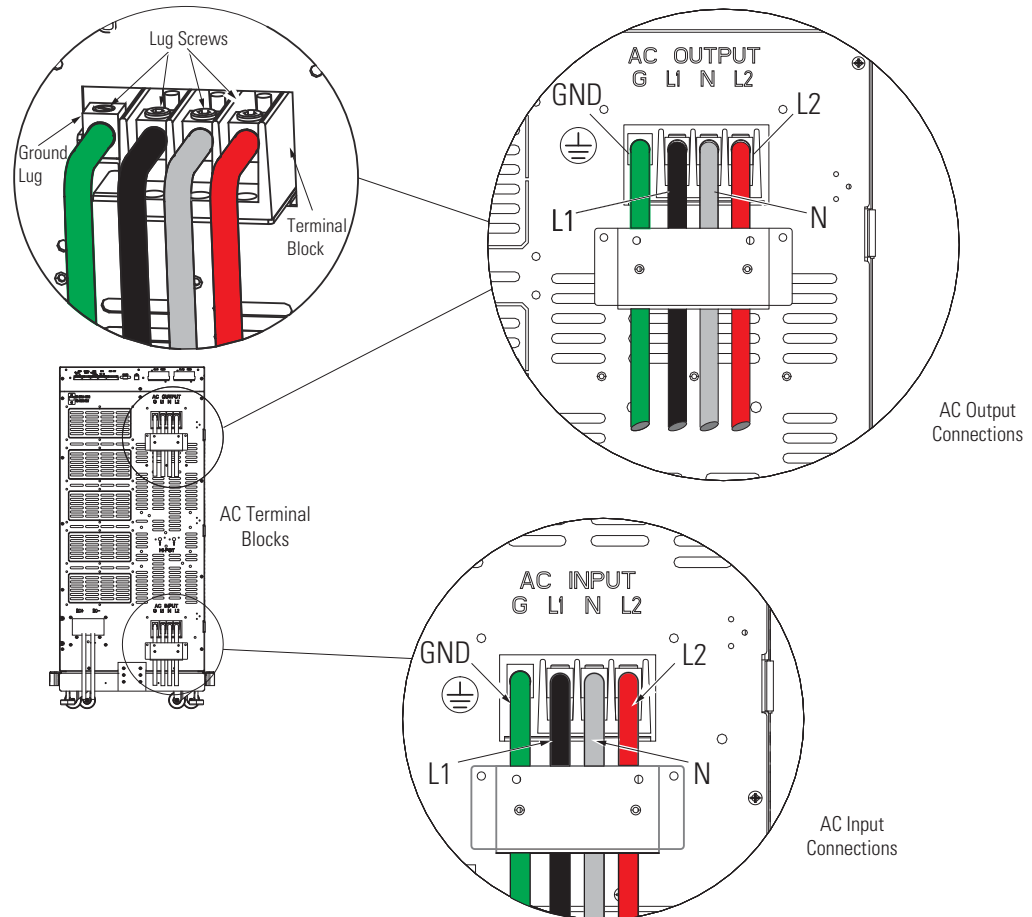

3. Make the UPS input and output connections to the terminal blocks on the rear panel (see [Figure 35](#)):

**NOTE**

UPS output circuits must be installed in separate conduit systems and not shared with other electrical circuits.

- a. Insert the L1, N and L2 cable ends into the applicable terminal slots on the terminal block.
 - b. Insert the G (GND) cable end into the ground lug on the rear panel.
 - c. Secure the cables by screwing down the lug screws.
4. Route and connect the AC input cables to the building service panel and the AC output cables to the load distribution panel as shown in [Figure 36](#).
 5. Torque the screws holding all input and output power conductors to the values specified in [Table 6](#).
 6. Install the supplied wiring connectors to the UPS input control signal wires and connect to the terminals as shown in . See , " [Figure 74](#) " from signal terminal identification.

7. When all connections have been made and checked, reinstall the UPS terminal covers using the original.
8. If floor anchor brackets were installed and not secured, install the floor bolts ([2.5 Anchor Bracket Installation](#)).
9. After electrical installation is complete, you must also set the output settings menu at UPS startup ([6.1 UPS Startup](#)) for the required output voltage as shown in the wiring configuration drawings ([7.15 Display Menu Screens](#)).

⚠ WARNING

Risk of electrical shock. Only qualified service personnel (such as a licensed electrician) should perform the electrical installation in this section.

4.3 System Wiring Diagram

NOTE 1 **The customer must provide input overcurrent protection.** See NEC Section 240-21 or local requirements. See [Table 5](#) for circuit breaker ratings to size the protection device according to local code requirements.

NOTE 2 **The customer must size the AC circuit conductors.** All AC circuit conductors, including the neutral conductor, must be the same size (ampacity), have the same rating (75°C) copper wire, and be sized according to the input circuit breaker. See [Table 6](#) for recommended wire sizes. The UPS input and output conductors must be run through separate conduits.

NOTE 3 **The customer must provide output overcurrent protection.** See NEC Section 240-21 or local requirements. See [Table 5](#) for maximum output overcurrent protection device ratings.



NOTE 4 See “[2.1 Preparing for Installation](#)” for installation and service clearances before installing the UPS. Use flexible conduit on the UPS or the external battery cabinet if either must be moved.

NOTE 5 External UPS battery cabinets are optional. See “[5.2 Standard Battery Cabinet Installation](#) or [5.1 Battery Cabinet Options](#)” for installation instructions.

NOTE 6 UPS output circuits shall be installed in dedicated conduit systems and not shared with other electrical circuits.

NOTE 7 Use only Eaton-supplied power cables between the UPS and EBM(s) (PN:P-103003231).

NOTE 8 CN3 and CN4 CAN cables ground separately to each cabinet chassis.

Figure 36. UPS with No External Bypass (L1,L2,N)

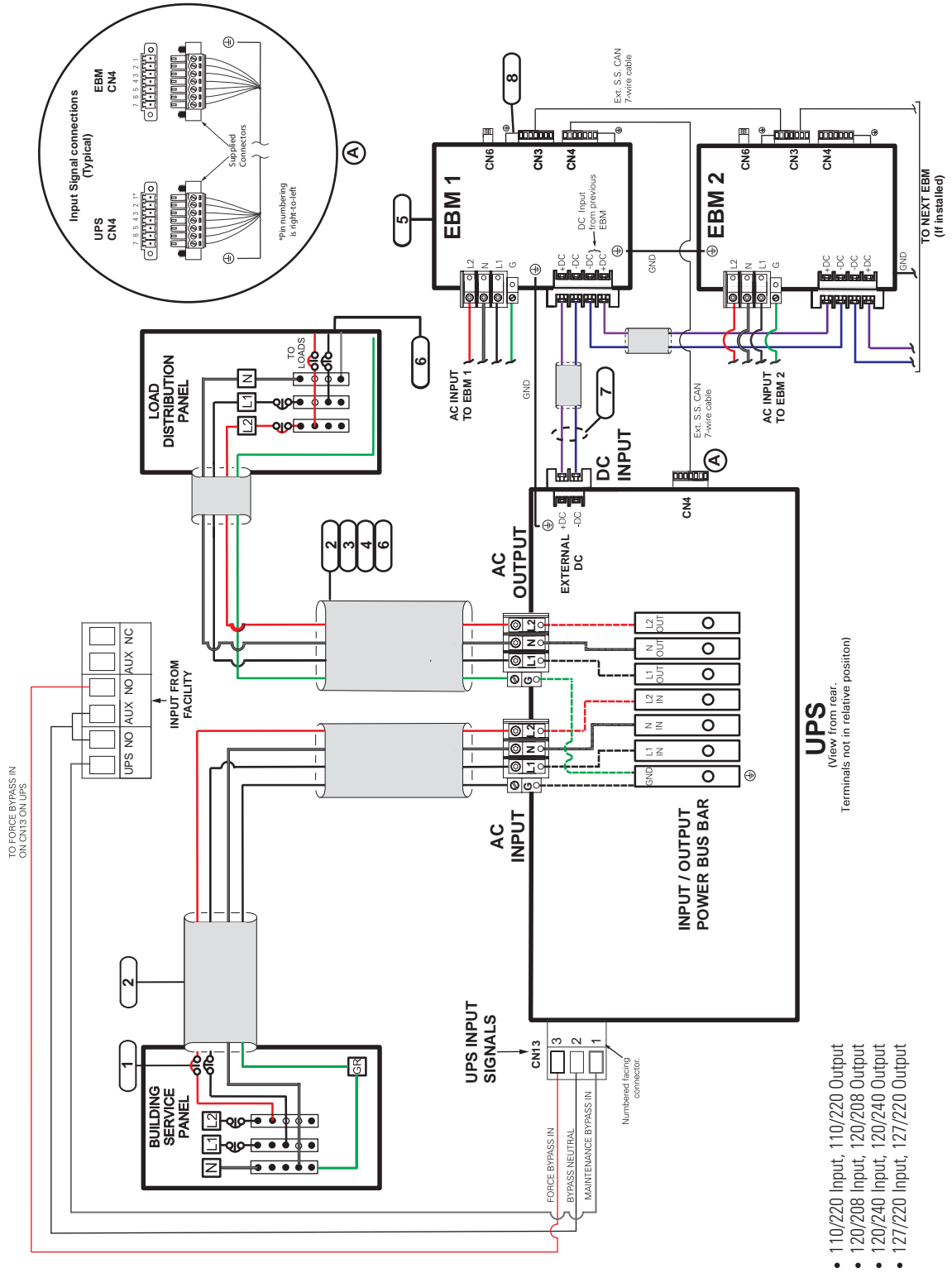

Figure 35. Wiring Diagram - UPS with No External Bypass (L1, L2, N)

System Wiring Diagram

Chapter 5 Battery Cabinet Installation

5.1 Battery Cabinet Options

Standard Battery Cabinet Option

The “Standard” battery cabinet option is available in 8 or 12 slot chassis sizes. The “Standard” battery cabinet does not have the capability for automatic monitoring via CAN communication. The “Standard” cabinet also does not support the installation of a super charger module.

- [5.2 Standard Battery Cabinet Installation](#) for extended runtime battery support. There is no capability of using a super charger module with this option.

Connected Battery Cabinet Options

The “Connected” battery cabinet option is available in 8 or 12 slot chassis sizes. The “Connected” battery cabinet does have the capability for automatic monitoring via CAN communication. The “Connected” cabinet does support the installation of a super charger module depending on the type of installation.

The following installation options are available for a “Connected” battery cabinet:

- [5.3 Connected Battery Cabinet With No AC Input](#) used for extended runtime battery support only. There is no capability of using a super charger module with this option.
- [5.4 Connected Battery Cabinet With 120VAC Input](#) used for automatic monitoring via CAN communication and extended runtime battery support. No capability of using a super charger module with this option.
- [5.5 Connected Battery Cabinet With Split Phase Input](#) used for automatic monitoring via CAN communication and extended runtime battery support. Capability of using a super charger module with this option..

5.2 Standard Battery Cabinet Installation



-
- Make sure all AC power is removed from the UPS. Observe all electrical safety precautions.
 - Only qualified service personnel (such as a licensed electrician) should perform the battery cabinet installation. Risk of electrical shock.
 - Before connecting an external battery cabinet to the UPS cabinet or to another external battery cabinet, verify that all AC input power is removed from the UPS. Open the input service circuit breaker or turn the external bypass switch to the SERVICE position. Observe all electrical safety precautions.
 - Remove all battery modules in the UPS cabinet and/or battery cabinet to ensure DC voltage is removed from the internal DC buses.
-

Figure 37. Standard EBM Front and Back

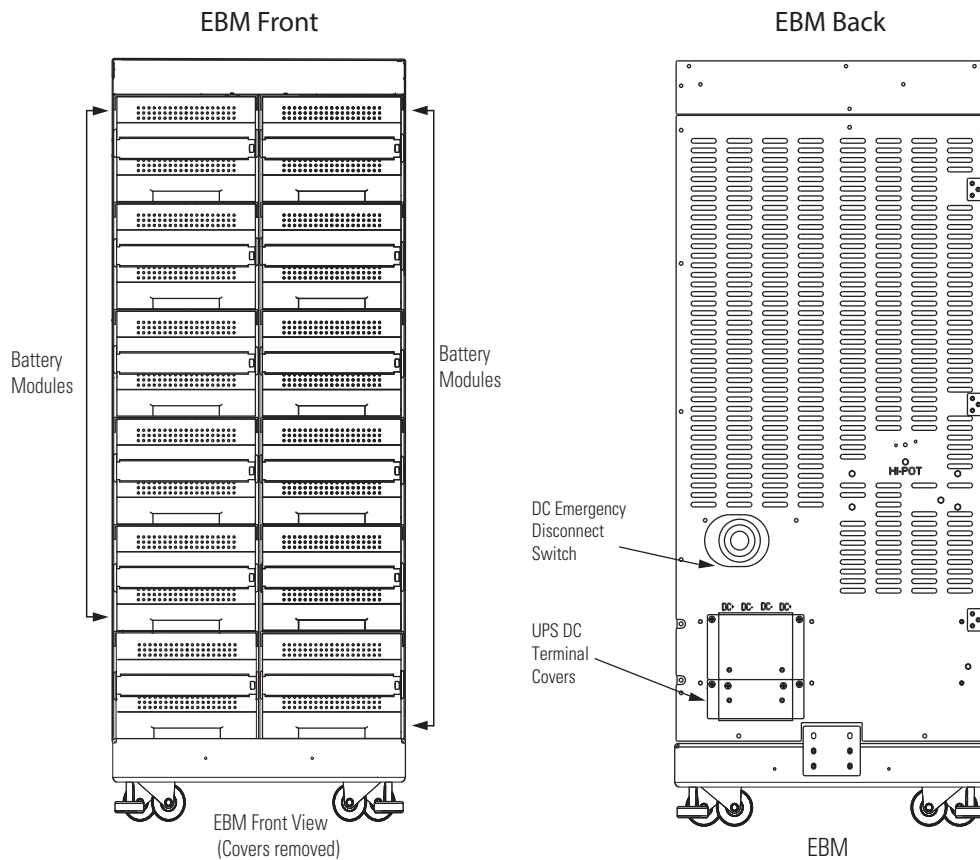

! IMPORTANT

- If you are installing multiple EBM(s) upstream to the UPS, repeat the setup as described in this section.
- The battery cables are supplied inside the battery cabinet accessory kit.
- In the UPS cabinet, the proper location of cabinet-to-cabinet DC wiring is on the lower left of the rear panel.
- All of the slots in the Standard 8 and 12 slot battery cabinets can be populated with batteries.

Prepare the EBM Cabinet

- NOTE 1** The external battery cabinets are the same dimensions as the UPS cabinets. Refer to the " [2.1 Preparing for Installation](#) " section for unpacking and cabinet setup.
- NOTE 2** If you are installing multiple EBM(s) upstream to the UPS, repeat the setup as described in this section.

1. Open the carton containing the external battery cabinet cable assembly and position it in the desired location next to the UPS.

- 2. If you are rack-mounting the EBM cabinet, refer to the UPS rack-mount installation procedure (see [2.6 Rack-Mount Installation](#)). If not, proceed to the next step.
- 3. Install the anchor brackets to the floor if applicable (see [2.5 Anchor Bracket Installation](#)).
- 4. Push in the EBM DC emergency disconnect switch on the rear EBM panel and turn the switch lockout key (see [Figure 37](#)).

NOTE The UPS and EBM AC/DC terminal covers are shipped in the UPS and EBM accessory kit and do not come installed on the UPS or EBM chassis.

- 1. Route the EBM DC input/output cables to the terminal blocks as shown in [Figure 38](#).

NOTE Torque the screws holding all input and output power conductors to the values specified in [Table 2](#).

- 2. Connect the EBM DC Cables to the applicable terminals by removing and reinstalling the screws onto the terminal blocks. See [Figure 38](#).

Figure 38. Standard EBM to UPS Connections

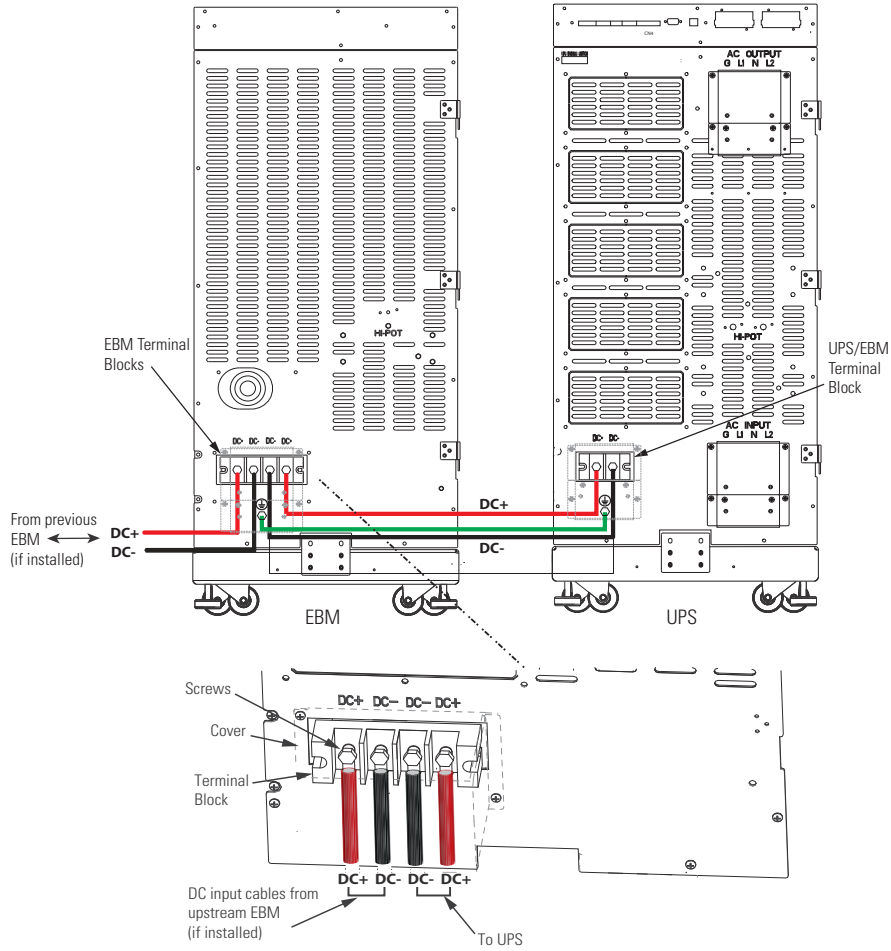

Connected Battery Cabinet With No AC Input

3. Reinstall the AC and DC terminal covers.
4. If additional battery cabinets are to be connected to the first, in a daisy-chain configuration, connect each EBM with the DC cables supplied in the EBM accessory kit.



NOTE DC input cables only required if EBM(s) are installed upstream.

5. Close the DC emergency disconnect switch button on the back of each EBM. Insert the switch key supplied with the cabinet into the button and turn clockwise 1/2-turn. Pull the button OUT to close the switch and reconnect DC power. Turn the key back counter-clockwise, and remove the key (see [Figure 39](#)).

Figure 39. EBM Emergency Disconnect Switch

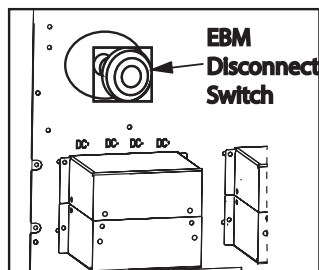

6. Proceed to Chapter [6.1 UPS Startup](#) and be sure to set the number of external battery strings on the UPS LCD for calculating the runtime. See [6.5 Initial Startup Parameters](#).

5.3 Connected Battery Cabinet With No AC Input

WARNING

- Make sure all AC power is removed from the UPS. Observe all electrical safety precautions.
 - Only qualified service personnel (such as a licensed electrician) should perform the battery cabinet installation. Risk of electrical shock.
 - Before connecting an external battery cabinet to the UPS cabinet or to another external battery cabinet, verify that all AC input power is removed from the UPS. Open the input service circuit breaker or turn the external bypass switch to the SERVICE position. Observe all electrical safety precautions.
 - Remove all battery modules in the UPS cabinet and/or battery cabinet to ensure DC voltage is removed from the internal DC buses.
-

Figure 40. Connected EBM Front And Back

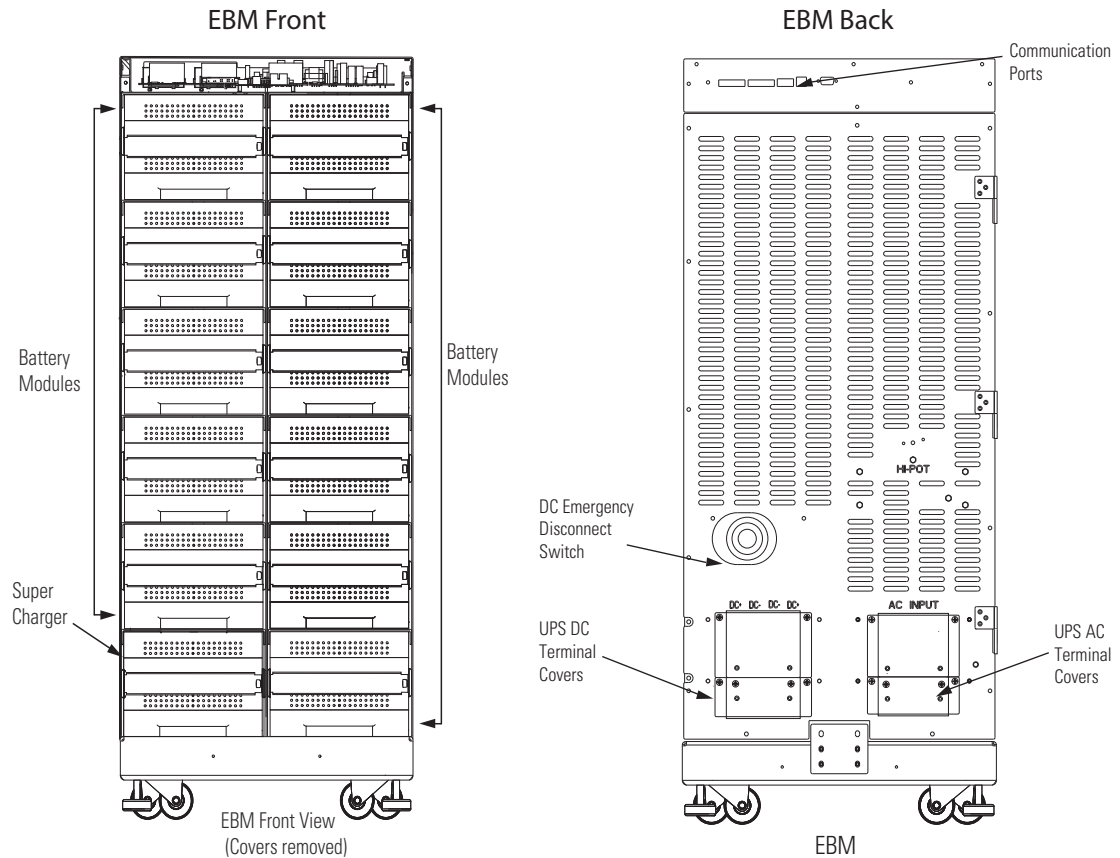

! IMPORTANT

- If you are installing multiple EBM(s) upstream to the UPS, repeat the setup as described in this section.
- The battery cables are supplied inside the battery cabinet accessory kit.
- In the UPS cabinet, the proper location of cabinet-to-cabinet DC wiring is on the lower left of the rear panel.
- All of the slots in the Standard 8 and 12 slot battery cabinets can be populated with batteries.

Prepare the EBM Cabinet

NOTE 1 The external battery cabinets are the same dimensions as the UPS cabinets. Refer to the " [2.1 Preparing for Installation](#) " section for unpacking and cabinet setup.



NOTE 2 If you are installing multiple EBM(s) upstream to the UPS, repeat the setup as described in this section.

1. Open the carton containing the external battery cabinet cable assembly and position it in the desired location next to the UPS.

Connected Battery Cabinet With No AC Input

2. If you are rack-mounting the EBM cabinet, refer to the UPS rack-mount installation procedure (see [2.6 Rack-Mount Installation](#)). If not, proceed to the next step.
3. Install the anchor brackets to the floor if applicable (see [2.5 Anchor Bracket Installation](#)).
4. Push in the EBM DC emergency disconnect switch on the rear EBM panel and turn the switch lockout key (see).

i NOTE The UPS and EBM AC/DC terminal covers are shipped in the UPS and EBM accessory kit and do not come installed on the UPS or EBM chassis.

5. Route the EBM DC input/output cables to the terminal blocks as shown in ([Figure 41](#)).

i NOTE Torque the screws holding all input and output power conductors to the values specified in [Table 2](#) .

6. Connect the EBM DC Cables to the applicable terminals by removing and reinstalling the screws onto the terminal blocks. See [Figure 41](#).

Figure 41. Connected EBM (No AC Input Option)

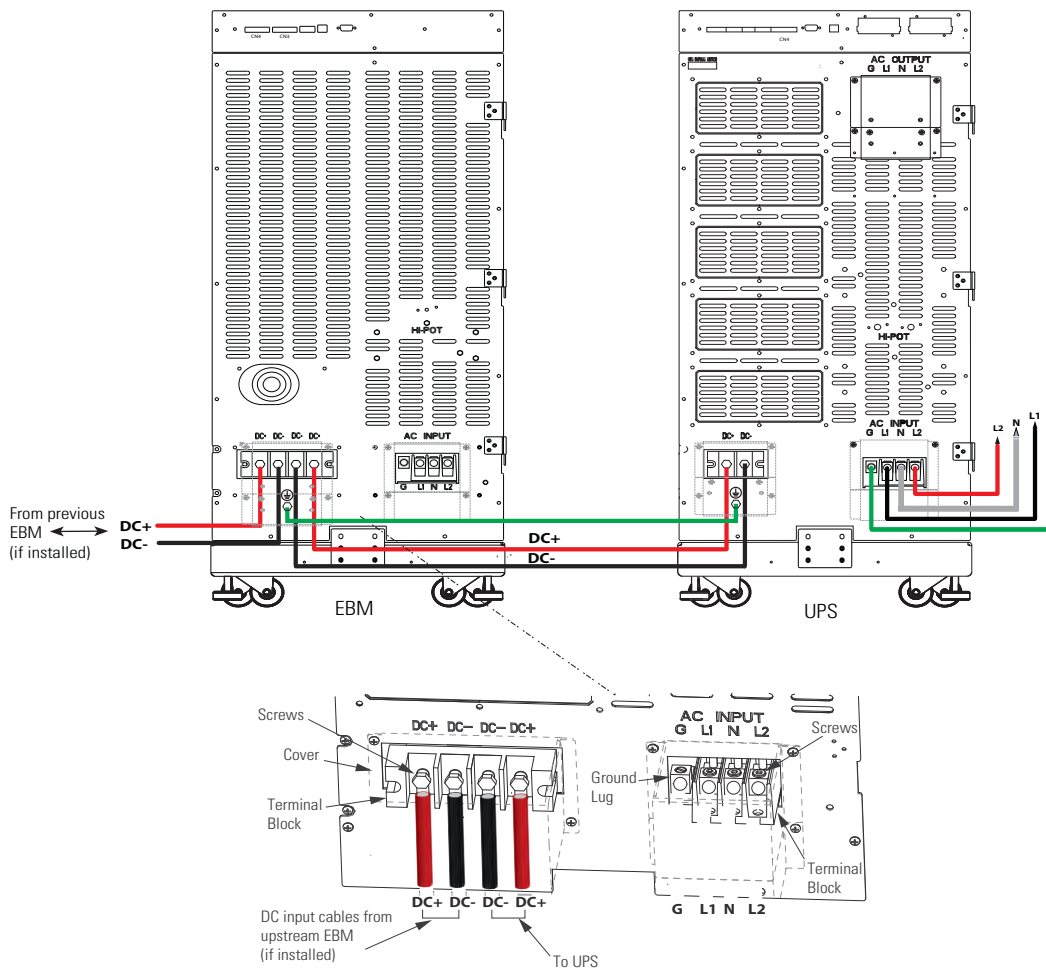

7. Reinstall the AC and DC terminal covers.
8. If additional battery cabinets are to be connected to the first, in a daisy-chain configuration, connect each EBM with the DC cables supplied in the EBM accessory kit.).



NOTE DC input cables only required if EBM(s) are installed upstream.

9. Close the DC emergency disconnect switch button on the back of each EBM. Insert the switch key supplied with the cabinet into the button and turn clockwise 1/2-turn. Pull the button OUT to close the switch and reconnect DC power. Turn the key back counter-clockwise, and remove the key (see [Figure 42](#)).

Figure 42. EBM Emergency Disconnect Switch

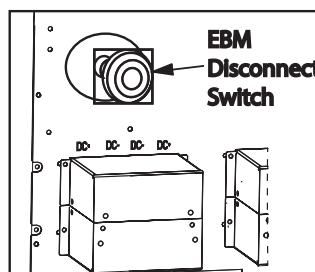

10. Proceed to Chapter [6.1 UPS Startup](#) and be sure to set the number of external battery strings on the UPS LCD for calculating the runtime. See [6.5 Initial Startup Parameters](#).

5.4 Connected Battery Cabinet With 120VAC Input

⚠ WARNING

- Make sure all AC power is removed from the UPS. Observe all electrical safety precautions.
- Only qualified service personnel (such as a licensed electrician) should perform the battery cabinet installation. Risk of electrical shock.
- For the 120V connected battery cabinet wiring option the EBM AC must be installed on its own dedicated 15 amp circuit, Do not connect the EBM AC input to the UPS.
- Before connecting an external battery cabinet to the UPS cabinet or to another external battery cabinet, verify that all AC input power is removed from the UPS. Open the input service circuit breaker or turn the external bypass switch to the SERVICE position. Observe all electrical safety precautions.
- Remove all battery modules in the UPS cabinet and/or battery cabinet to ensure DC voltage is removed from the internal DC buses.

Figure 43. Connected EBM Front And Back

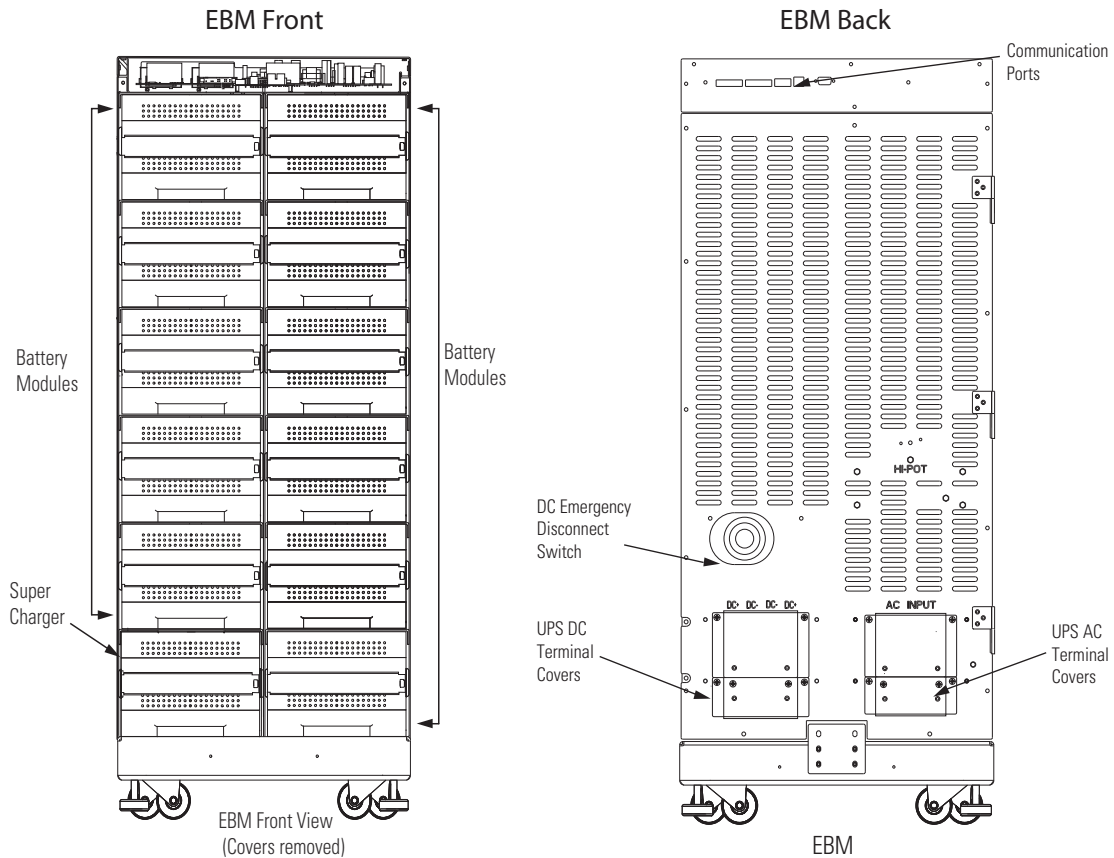

! IMPORTANT

- The external battery cabinets are the same dimensions as the UPS cabinets. Refer to the “[2.1 Preparing for Installation](#)” section for unpacking and cabinet setup.
- If you are installing multiple EBM(s) upstream to the UPS, repeat the setup as described in this section.
- The battery cables are supplied inside the battery cabinet accessory kit.
- In the UPS cabinet, the proper location of cabinet-to-cabinet DC wiring is on the lower left of the rear panel.
- All of the slots in the Standard 8 and 12 slot battery cabinets can be populated with batteries.

Prepare the EBM Cabinet

1. Open the carton containing the external battery cabinet cable assembly and position it in the desired location next to the UPS.



NOTE

The UPS / EBM AC/DC terminal covers are shipped in the UPS and EBM accessory kit and do not come installed on the UPS or EBM chassis.

2. If you are rack-mounting the EBM cabinet, refer to the UPS rack-mount installation procedure (see [2.6 Rack-Mount Installation](#)). If not, proceed to the next step.
3. Install the anchor brackets to the floor if applicable (see [2.5 Anchor Bracket Installation](#)).
4. Push in the EBM DC emergency disconnect switch on the rear EBM panel and turn the switch lockout key.
5. Route the EBM DC input/output cables to the terminal blocks as shown in [Figure 44](#).

NOTE Torque the screws holding all input and output power conductors to the values specified in [Table 2](#).

6. Connect the EBM DC Cables to the applicable terminals by removing and reinstalling the screws onto the terminal blocks. See [Figure 44](#).

Figure 44. Connected EBM (120V AC Option)

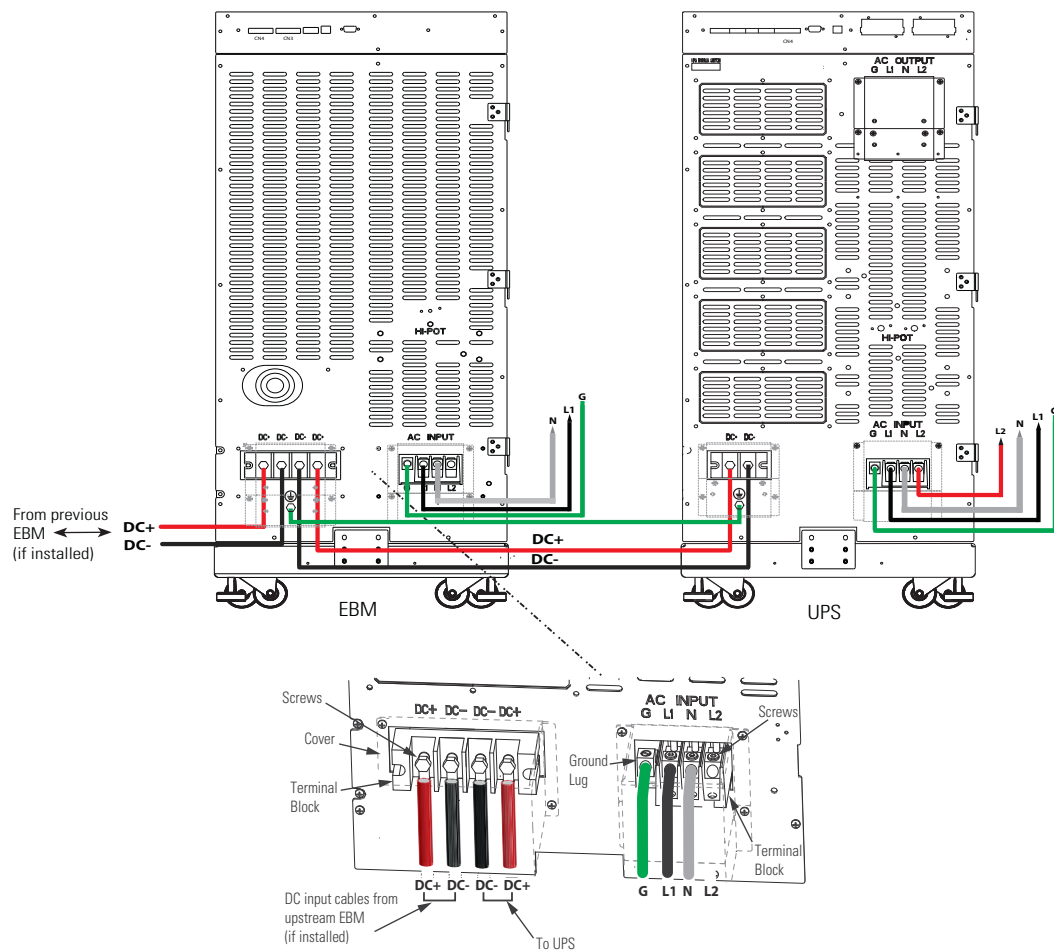

7. Reinstall the AC and DC terminal covers.
8. If additional battery cabinets are to be connected to the first, in a daisy-chain configuration, connect each EBM with the DC cables supplied in the EBM accessory kit.

NOTE DC input cables only required if EBM(s) are installed upstream.

9. On the upper rear UPS and EBM panels, connect the input signal cables from the EBM CN4 to the UPS input signal port CN4 using the supplied cables. (See).
10. If additional battery cabinets are to be connected to the first, in a daisy-chain configuration, connect each EBM with signal cables from CN3 to CN4 (see [Figure 45](#)).

Figure 45. UPS Input Control Signal Wiring (For External Controls)

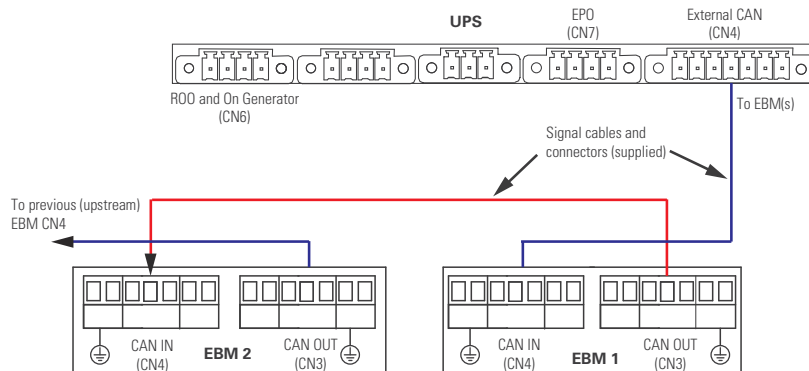

11. Connect the CAN cable ground wires to the EBM chassis.

NOTE Connect each CAN ground wires to separate screws on the chassis. See [Figure 46](#) .

Figure 46. Securing The CAN Ground Wire

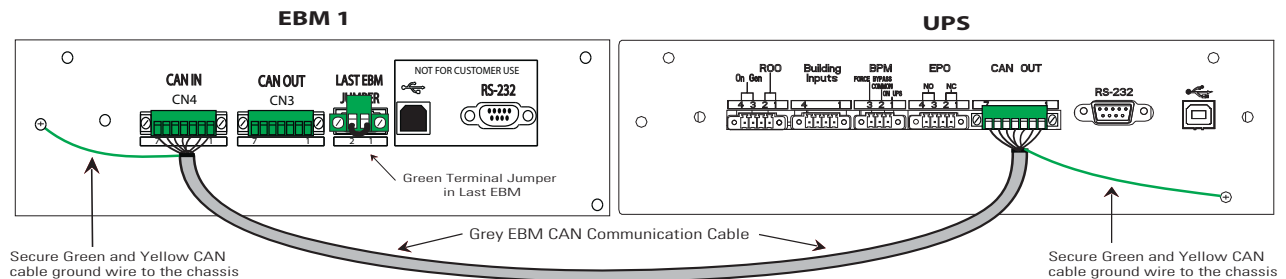

12. Close the DC emergency disconnect switch button on the back of each EBM. Insert the switch key supplied with the cabinet into the button and turn clockwise 1/2-turn. Pull the button OUT to close the switch and reconnect DC power. Turn the key back counter-clockwise, and remove the key (see [Figure 47](#)).

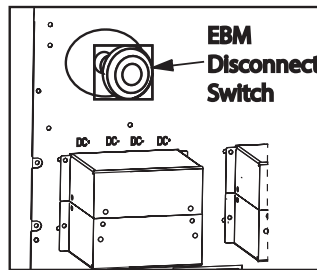
Figure 47. EBM Emergency Disconnect Switch

13. Proceed to Chapter 6 UPS Startup. See [6.5 Initial Startup Parameters](#).

5.5 Connected Battery Cabinet With Split Phase Input

The connected Eaton 9PXM split phase input option will provide the UPS additional extended runtime and external battery string monitoring. Use of a supercharger is also supported with this installation option.

⚠ WARNING

- Make sure all AC power is removed from the UPS. Observe all electrical safety precautions.
 - Only qualified service personnel (such as a licensed electrician) should perform the battery cabinet installation. Risk of electrical shock.
 - For the **120V/208V** or **120V/240V** wiring option the EBM AC input must be installed on its own dedicated 30 amp circuit. Do not connect the EBM AC input to the UPS.
 - Before connecting an external battery cabinet to the UPS cabinet or to another external battery cabinet, verify that all AC input power is removed from the UPS. Open the input service circuit breaker or turn the external bypass switch to the SERVICE position. Observe all electrical safety precautions.
 - Remove all battery modules in the UPS cabinet and/or battery cabinet to ensure DC voltage is removed from the internal DC buses.
-

Figure 48. Connected EBM Front And Back

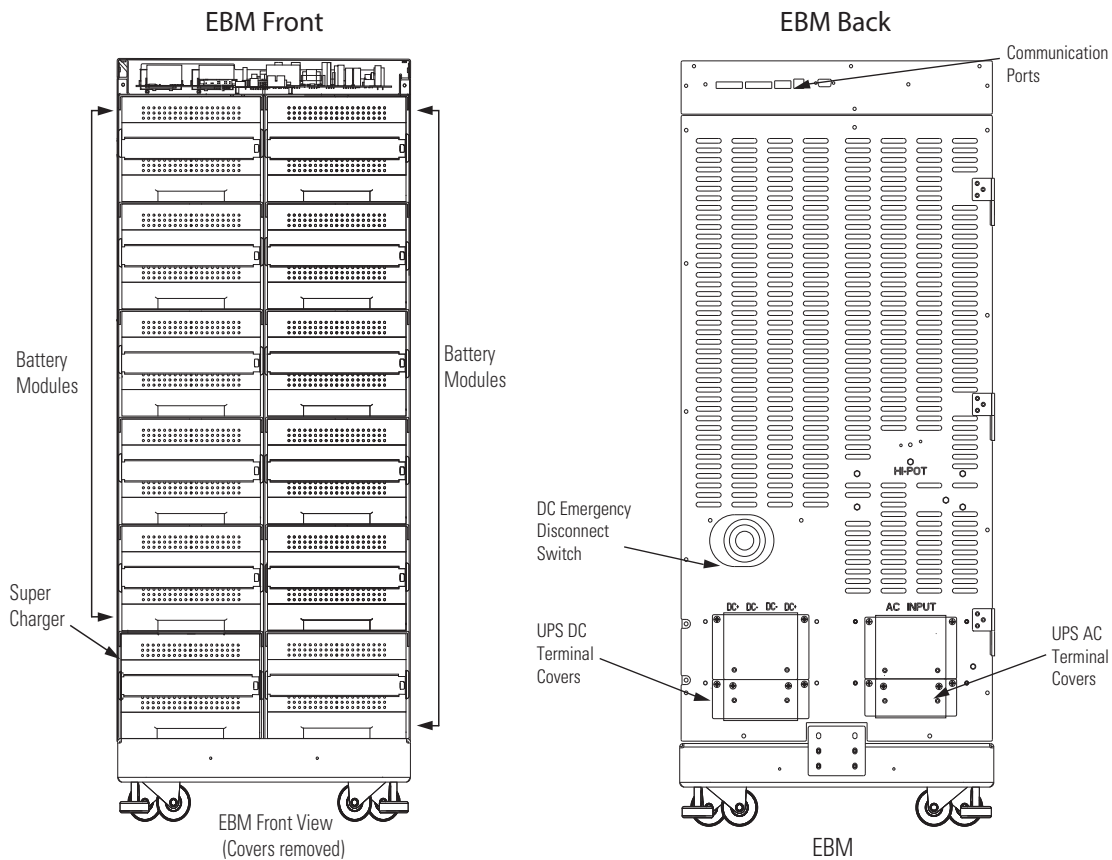

! IMPORTANT

- The external battery cabinets are the same dimensions as the UPS cabinets. Refer to the “[2.1 Preparing for Installation](#)” section for unpacking and cabinet setup.
- If you are installing multiple EBM(s) upstream to the UPS, repeat the setup as described in this section.
- The battery cables are supplied inside the battery cabinet accessory kit.
- In the UPS cabinet, the proper location of cabinet-to-cabinet DC wiring is on the lower left of the rear panel.
- All of the slots in the Standard 8 and 12 slot battery cabinets can be populated with batteries.

Prepare the EBM Cabinet

1. Open the carton containing the external battery cabinet cable assembly and position it in the desired location next to the UPS.



NOTE

The UPS / EBM AC/DC terminal covers are shipped in the UPS and EBM accessory kit and do not come installed on the UPS or EBM chassis.

2. If you are rack-mounting the EBM cabinet, refer to the UPS rack-mount installation procedure (see [2.6 Rack-Mount Installation](#)). If not, proceed to the next step.
3. Install the anchor brackets to the floor if applicable (see [2.5 Anchor Bracket Installation](#)).
4. Push in the EBM DC emergency disconnect switch on the rear EBM panel and turn the switch lockout key.
5. Route the EBM DC input/output cables to the terminal blocks as shown in [Figure 49](#).



NOTE Torque the screws holding all input and output power conductors to the values specified in [Table 2](#).

6. Connect the EBM DC Cables to the applicable terminals by removing and reinstalling the screws onto the terminal blocks. See [Figure 49](#).

Figure 49. Connected EBM (Split Phase Input)

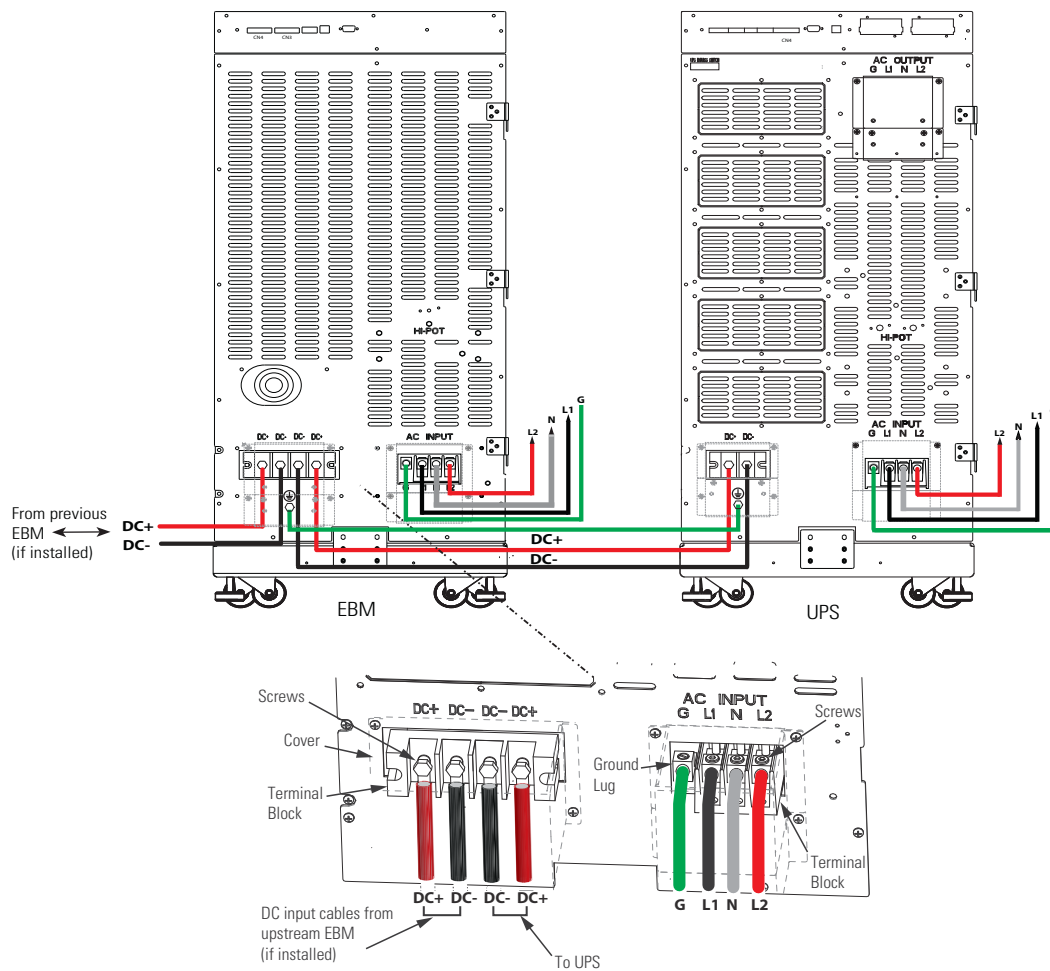

7. Reinstall the AC and DC terminal covers.
8. If additional battery cabinets are to be connected to the first, in a daisy-chain configuration, connect each EBM with the DC cables supplied in the EBM accessory kit.

NOTE DC input cables only required if EBM(s) are installed upstream.

9. On the upper rear UPS and EBM panels, connect the input signal cables from the EBM CN4 to the UPS input signal port CN4 using the supplied cables. (See [Figure 50](#)).
10. If additional battery cabinets are to be connected to the first, in a daisy-chain configuration, connect each EBM with signal cables from CN3 to CN4 (see [Figure 50](#)).

Figure 50. UPS Input Control Signal Wiring (For External Controls)

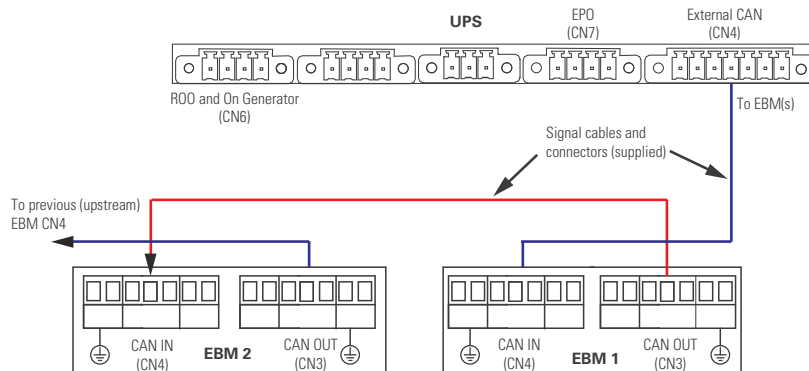

11. Connect the CAN cable ground wires to the EBM chassis.

NOTE Connect each CAN ground wires to separate screws on the chassis. See [Figure 51](#).

Figure 51. Securing The CAN Ground Wire

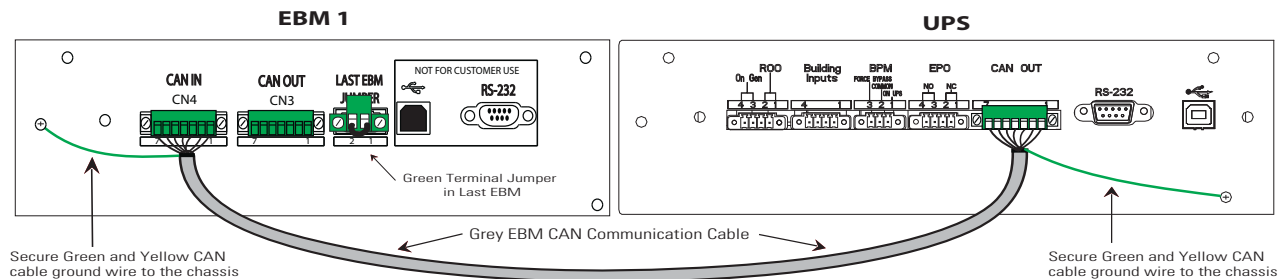

12. Close the DC emergency disconnect switch button on the back of each EBM. Insert the switch key supplied with the cabinet into the button and turn clockwise 1/2-turn. Pull the button OUT to close the switch and reconnect DC power. Turn the key back counter-clockwise, and remove the key (see [Figure 52](#)).

Figure 52. EBM Emergency Disconnect Switch

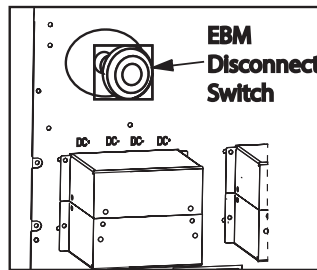

13. Proceed to Chapter [6.1 UPS Startup](#).

Connected Battery Cabinet With Split Phase Input

Chapter 6 UPS Startup

6.1 UPS Startup

CAUTION

- This UPS contains its own energy source (batteries). The output receptacles may carry hazardous voltage even when the UPS is not connected to an AC supply. When AC input voltage is present, the Eaton 9PXM system can provide output voltage even though its batteries are disconnected. To confirm that there is no UPS output voltage, always disconnect all of the AC input sources and unplug all two battery modules per slot of internal batteries; if the UPS has one or more separate battery cabinets (EBMs), open (push in) the DC emergency disconnect switch button on each battery cabinet or unplug two battery modules in each slot of the battery cabinet.
- To reduce the risk of fire or electric shock, install this UPS in a temperature and humidity controlled, indoor environment, free of conductive contaminants. Ambient temperature must not exceed 40°C (104°F). Do not operate near water or excessive humidity (95% maximum).
- For optimum battery life, ambient temperature should not exceed 25°C (77°F). Battery life is substantially reduced if ambient temperature is higher.
- Do NOT attempt to move the cabinet with the power or battery modules installed.

The UPS power modules (UPMs) are installed in the left hand slots of the UPS facing the user. Battery modules are installed in the left or right hand slots (it takes two battery modules per slot to equal one battery string). Removal of the power modules and battery modules is the reverse of these procedures.

Install the UPMs into the Eaton 9PXM cabinet: as follows:

1. Remove the front cover(s) of the cabinet. The covers have magnetic latches on the left and right sides that hold them in place.

NOTE 1 Place battery modules beside all power modules in the UPS cabinet. Two battery modules installed on top of each other are required for each battery slot and can be removed separately.

NOTE 2 If you are installing a super charger module in the UPS, the super charger can be installed in any of the left side slots. In the EBM, the super charger can only be installed in the lower left side slot.



NOTE 3 The installation procedures of the optional battery cabinet (EBM) battery, and super charger modules are identical to the UPS units.

NOTE 4 Battery modules are shipped fully charged. It is recommended to charge the batteries for 48 hrs. after installation to ensure full power. If AC power fails before full battery charge, backup will be available but for a reduced duration.

2. Insert the power modules into the left hand slots of the cabinet. Push each module firmly until it contacts the connections in the rear of the slot.
3. Tighten the captive screw
4. To install the battery modules
 - Slide the lower battery module fully into the slot until it contacts the connections in the rear of the slot.
 - Repeat the procedure with the upper battery module.
 - Install the retaining bracket and tighten the captive screw with a Phillips screwdriver.

Figure 53. Inserting the Modules

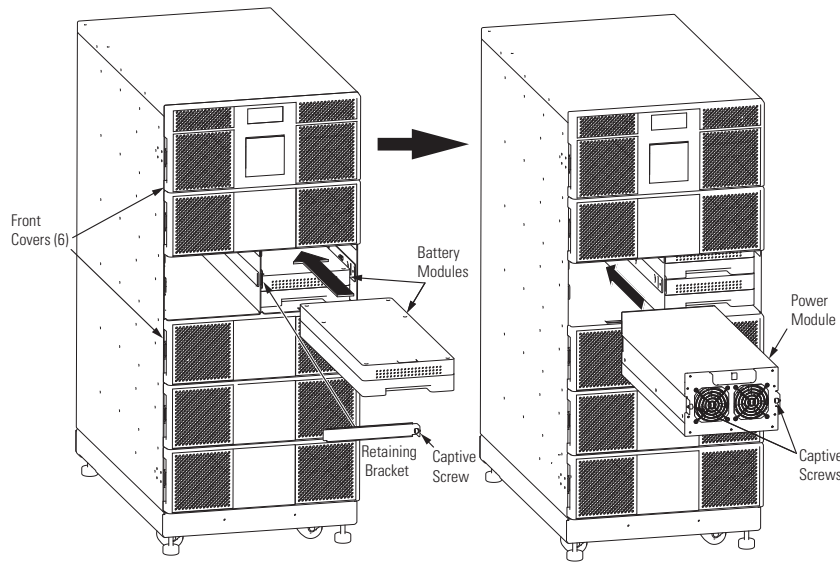

5. If you installed the optional battery cabinets (EBMs), install the battery modules using the same procedure as the UPS modules. If applicable, install the super charger in the lower left slot of the EBM. See [Figure 54](#)

Figure 54. EBM Battery Modules and Charger

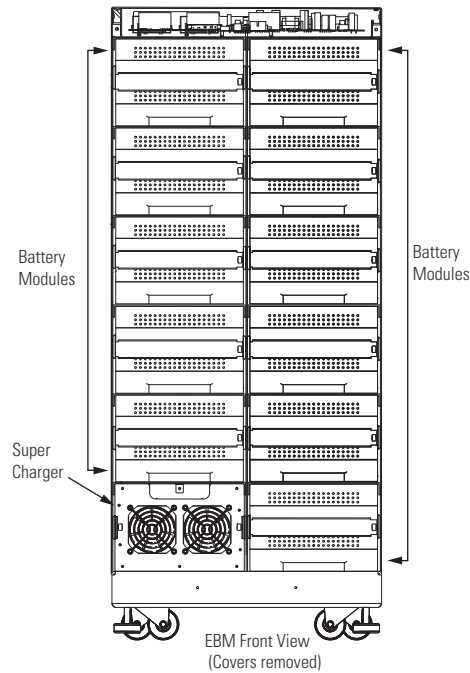

- Replace the front covers and continue to “ [6.2 UPS Startup Without an External Bypass Switch](#), [6.3 Startup for Units Installed with an Eaton BPM Bypass Switch](#) or [6.4 Startup for Units installed with a BPE Type Switch](#) ”.

6.2 UPS Startup Without an External Bypass Switch

To start the UPS unit for the first time after installation:

- If external battery cabinets (EBMs) are installed, check the cable connections between the UPS and external battery cabinets (see , “ [5.2 Standard Battery Cabinet Installation](#) or [5.1 Battery Cabinet Options](#) ”).
- Ensure that all power modules and battery modules are properly installed into the UPS cabinet.
- If you are using power management software, connect your computer to either the DB9 or USB communication ports on the top rear panel using the supplied communication cables.

Figure 55. Communication Ports

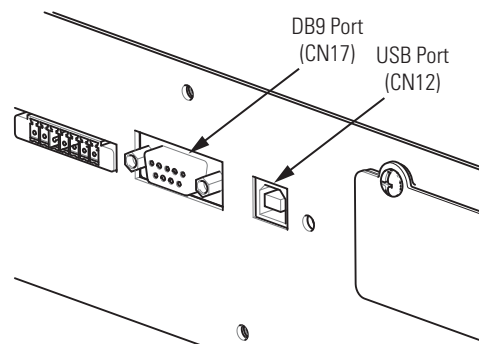

- When starting the UPS, apply input power to the UPS by closing the service circuit breaker:
 - If external battery cabinets are installed, close the DC emergency disconnect switch button on the back of each external battery cabinet. Insert the switch key supplied with the cabinet into the button and turn clockwise 1/2-turn. Pull the button out to close the switch. Turn the key back counter-clockwise, and remove the key.
- The UPS control panel display automatically turns on whenever input power is present and at least one power module is installed (see , “ [6.1 UPS Startup](#) ”).
- Set up the initial operating parameters through the control panel display (see “ [6.5 Initial Startup Parameters](#) ”).
- If applicable, test proper operation of optional external control signals and computer communication before connecting the load. (See “ [8.5 DB-9 Communication Port](#) ” for details.)
- If there are receptacles on the UPS rear panel, plug the equipment to be protected into the UPS output receptacles.



NOTE

DO NOT protect laser printers with the UPS because of the exceptionally high power requirements of the heating elements.

- Turn on the equipment that is connected to the UPS.
- If there is an external bypass switch, ensure a proper phase check has been completed then turn the switch to UPS. Otherwise, close the load distribution circuit breaker(s).

6.3 Startup for Units Installed with an Eaton BPM Bypass Switch

1. If your unit is wired to an external BPM bypass switch, you must perform a voltage and phase check (Steps 2 through 1). Otherwise, skip to Step 1 .

⚠ WARNING

Before operating the bypass switch, use the following procedure to check the wiring for correct installation. To prevent damage to the load, turn off the main circuit breaker in the load service panel or verify that the load cannot receive power from the UPS.

If the UPS is in the standby mode and the bypass switch is in the LINE or UPS positions pressing the red bypass switch interlock button will energize the UPS output.

Do not attempt to push the red interlock button or attempt to move the bypass switch handle if the UPS is operating on battery power.



2. At the bypass switch, press the red button and turn the switch to UPS.
3. Remove the six screws in the bypass switch front cover and remove the cover to gain access to the terminal block for voltage measurements.
4. If external battery cabinets are installed, ensure that the battery cabinet is plugged into its external AC source (if applicable) and close the DC emergency disconnect switch button on the back of each external battery cabinet. Insert the switch key supplied with the cabinet into the button and turn clockwise 1/2-turn. Pull the button out to close the switch. Turn the key back counter-clockwise, and remove the key.
5. The UPS front panel display automatically turns on whenever input power is present and at least one power module is installed. Set up the initial operating parameters through the front panel display (see “ [6.5 Initial Startup Parameters](#) ”).
6. Use an AC voltmeter to measure voltages on the terminal block inside the bypass switch cabinet. See [Figure 19](#) , which shows the terminal numbering for input and output UPS connections.
7. Record your measurements in the following chart. The voltages in the first column should be nearly equal to the voltages in the second column. If the values differ by more than a few volts, check the terminal block connections and correct any wiring problems.

AC Line Input	Measurement	AC from UPS Output	Measurement
L1 to L2 (7 to 8*)		3 to 4*	
N to L1 (6 to 7*)		2 to 3*	
N to L2 (6 to 8*)		2 to 4*	

8. Verify that the AC voltages from the UPS and the AC line input are in phase. Measure the voltage between the following points on the terminal block and record in the spaces below. These measurements must be no more than 20 Vac; if they are, call your service representative.

Terminal 3 (AC From UPS Output) To Terminal 7 (AC To UPS Input)

Terminal 4 (AC From UPS Output) To Terminal 8 (AC To UPS Input)

9. Measure the AC voltage between the following points on the terminal block and record in the space below. This reading must be no more than 1 Vac; if it is, call your service representative.

Terminal 2 (AC From UPS Output) to 6 (AC Line Input)

10. Switch the bypass switch to LINE. Measure the voltage to the protected equipment (at the load distribution panel) and verify that it is correct.
11. Switch the bypass switch to UPS and verify the voltage to the protected equipment is still correct.
12. Reinstall the bypass switch front cover and UPS front covers using the original screws.
13. If the UPS will not be operated immediately, switch the bypass switch to SERVICE and push in the DC emergency disconnect switch button on the back panel of the external battery cabinet closest to the UPS. Otherwise, continue to Step 14 to continue the UPS startup.
14. When starting the UPS, apply input power to the UPS by closing the service circuit breaker:

If external battery cabinets are installed, close the DC emergency disconnect switch button on the back of each external battery cabinet. Insert the switch key supplied with the cabinet into the button and turn clockwise 1/2-turn. Pull the button out to close the switch. Turn the key back counter-clockwise, and remove the key.
15. The UPS front panel display automatically turns on whenever input power is present and at least one power module is installed. Set up the initial operating parameters through the front panel display (see “[6.5 Initial Startup Parameters](#)”).
16. If applicable, test proper operation of optional external control signals and computer communication before connecting the load.
17. If there are receptacles on the UPS rear panel, plug the equipment to be protected into the UPS output receptacles.



NOTE

DO NOT protect laser printers with the UPS because of the exceptionally high power requirements of the heating elements.

18. Turn on the equipment that is connected to the UPS.
19. If there is an external bypass switch, turn it to UPS. Otherwise, close the load distribution circuit breaker (s).

6.4 Startup for Units installed with a BPE Type Switch

1. If your unit is wired to an external bypass switch, you must perform a voltage and phase check (Steps 2 through 13). Otherwise, skip to Step 14.

WARNING

Before operating the bypass switch, use the following procedure to check the wiring for correct installation. To prevent damage to the load, turn off the main circuit breaker in the load service panel or verify that the load cannot receive power from the UPS.

If the UPS is in the standby mode and the bypass switch is in the LINE or UPS positions pressing the red bypass switch interlock button will energize the UPS output.

Do not attempt to push the red interlock button or attempt to move the bypass switch handle if the UPS is operating on battery power.

2. At the bypass switch, press the red button and turn the switch to UPS.

Startup for Units installed with a BPE Type Switch

3. Remove the six screws in the bypass switch front cover and remove the cover to gain access to the terminal block for voltage measurements.
4. If external battery cabinets are installed, ensure that the battery cabinet is plugged into its external AC source (if applicable) and close the DC emergency disconnect switch button on the back of each external battery cabinet. Insert the switch key supplied with the cabinet into the button and turn clockwise 1/2-turn. Pull the button out to close the switch. Turn the key back counter-clockwise, and remove the key.
5. The UPS front panel display automatically turns on whenever input power is present and at least one power module is installed. Set up the initial operating parameters through the front panel display (see “[6.5 Initial Startup Parameters](#)”).
6. Use an AC voltmeter to measure voltages on the terminal block inside the bypass switch cabinet. See [Figure 19](#), which shows the terminal numbering for input and output UPS connections.
7. Record your measurements in the following chart. The voltages in the first column should be nearly equal to the voltages in the second column. If the values differ by more than a few volts, check the terminal block connections and correct any wiring problems.

AC Line input	Measurement	AC from UPS Output	Measurement
L1 to L2 (11 to 12*)		7 to 8*	
N to L1 (10 to 11*)		6 to 7*	
N to L2 (10 to 12*)		6 to 8*	

* For some installations, there is no connection at terminals 6, 8, 10, or 12.

8. Determine what type of bypass switch you are using:

If the bypass switch is a Break-Before-Make type, skip this step and proceed to Step 13.

If the bypass switch is a Make-Before-Break type, verify that the AC voltages from the UPS and the AC line input are in phase. Measure the voltage between the following points on the terminal block and record in the spaces below. These measurements must be no more than 20 Vac; if they are, call your service representative.

Terminal 7 to 11

Terminal 8 to 12

9. Measure the AC voltage between the following points on the terminal block and record in the space below. This reading must be no more than 1 Vac; if it is, call your service representative.

Terminal 6 to 10

10. Switch the bypass switch to LINE. Measure the voltage to the protected equipment (at the load distribution panel) and verify that it is correct.
11. Switch the bypass switch to UPS and verify the voltage to the protected equipment is still correct.
12. Reinstall the bypass switch front cover and UPS front covers using the original screws.
13. If the UPS will not be operated immediately, switch the bypass switch to SERVICE and push in the DC emergency disconnect switch button on the back panel of the external battery cabinet closest to the UPS. Otherwise, continue to Step 14.

14. When starting the UPS, apply input power to the UPS by closing the service circuit breaker: If external battery cabinets are installed, close the DC emergency disconnect switch button on the back of each external battery cabinet. Insert the switch key supplied with the cabinet into the button and turn clockwise 1/2-turn. Pull the button out to close the switch. Turn the key back counter-clockwise, and remove the key.
15. The UPS front panel display automatically turns on whenever input power is present and at least one power module is installed. Set up the initial operating parameters through the front panel display (see “[6.5 Initial Startup Parameters](#)”).
16. If applicable, test proper operation of optional external control signals and computer communication before connecting the load.
17. If there are receptacles on the UPS rear panel, plug the equipment to be protected into the UPS output receptacles.

**NOTE**

DO NOT protect laser printers with the UPS because of the exceptionally high power requirements of the heating elements.

18. Turn on the equipment that is connected to the UPS.
19. If there is an external bypass switch, turn it to UPS. Otherwise, close the load distribution circuit breaker (s).

6.5 Initial Startup Parameters

The first time the UPS is turned on, you must set or verify certain operating parameters before placing the UPS into operation. To set these initial configuration parameters:

1. After the Eaton® logo screen appears, select the desired language for the display. Use the and buttons to scroll between English, French, and Spanish. Enter your selection by pressing the button.



2. Select the desired UPS output voltage using the ▲ and ▼ buttons. Possible selections are 100/200, 110/220, 120/208, 120/240, 127/220 Vac. Press the ← button when the desired output value is displayed.
3. Set the clock for the local time and date.
 - If the time or the date is correct as displayed, press the button to advance to the next configuration setting. Time must be entered in 24-hour format.
 - If the time is incorrect as displayed, select the desired format and press the <- and -> buttons to move left and right. Press the ▲ and ▼ buttons to increase or decrease the value of each selected digit. When the displayed value is correct, press the button.

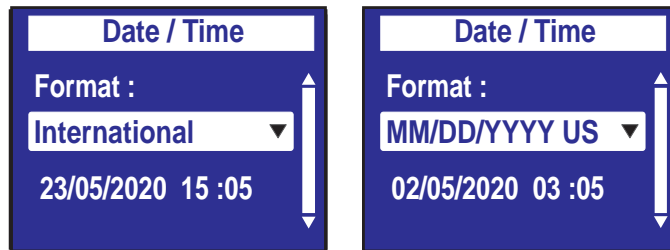

4. Select 'Register product' from the menu and register your product with Eaton.



5. The system signals an alarm when the required output cannot be maintained with the loss of redundant power modules. The alarm is essentially disabled with a redundancy level set at 0.
6. **Optional.** If you want the system to notify you when the number of redundant power modules is less than a specified level, enter a redundancy level. Each increment above 0 indicates the number of modules that can be removed from operation before the alarm occurs. This setting affects only the alarm; the system continues to operate as an N+X system even if this parameter is left at the default value of 0 (see also [Figure 64](#)).

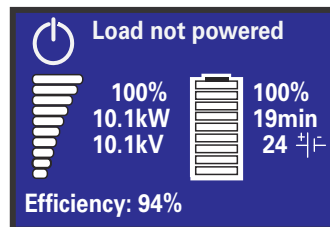





7. If you have a “Standard” Eaton 9PXM battery cabinet or a “Connected” No AC battery cabinet option installed navigate to the battery settings menu and set the number of external battery strings that you have installed. See “[5.2 Standard Battery Cabinet Installation](#)” or [5.1 Battery Cabinet Options](#)”
8. The UPS is now ready to operate, and displays the normal On/Off function screen. Press the ON button on the display screen to start the UPS. See [Figure 56](#) .

Chapter 7 Operation

7.1 Normal Operation

To operate the UPS:

1. Verify the UPS startup procedure has been completed (see , “[6.1 UPS Startup](#)”)
2. The UPS control panel display illuminates and shows the EATON logo. See “ [Figure 59](#) ”.
3. Verify that the power-on symbol  shows on the UPS status screen.
4. Press the  button on the UPS front panel until a beep sounds.
5. Check the UPS front panel display for active alarms or notices. Resolve any active alarms before continuing. See , “[11.1 Troubleshooting](#)” . If the  indicator is on, do not proceed until all alarms are clear. Check the UPS status from the front panel to view the active alarms. Correct the alarms and restart if necessary.
6. Verify that the  indicator illuminates solid, indicating that the UPS is operating normally and any loads are powered and protected.
7. Make sure the UPS is in Online mode.

7.2 UPS Standby Mode

To place the UPS in standby:

Press the  button on the front panel for three seconds.

- The UPS starts to beep then transfers to Standby mode.
- The  indicator will flash continually.

7.3 UPS Shutdown

CAUTION

Observe all Lock-Out / Tag-Out procedures when external power is removed.

To shutdown the UPS completely:

- Place the UPS in standby
- Remove AC power by opening the building service circuit breaker or placing the bypass switch in SERVICE (if installed). Remove DC power by pressing the DC disconnect switch on the back of the EBM(s) and removing all battery modules from the UPS cabinet.

7.4 Operating Modes

7.4.1 Online Mode

The Eaton 9PXM front panel indicates the UPS status through the UPS indicators, see page 11.

Online Mode

During Online mode, the  indicator illuminates solid and the UPS is powered from the utility. The UPS monitors and charges the batteries as needed and provides filtered power protection to your equipment.

7.4.2 Battery Mode

Battery Mode

When the UPS is operating during a power outage, the alarm beeps once every ten seconds and the indicator illuminates solid. The necessary energy is provided by the battery. When the utility power returns, the UPS transfers to Online mode operation while the battery recharges.

Low-Battery Warning

CAUTION

If the low battery warning occurs, shutdown all applications on the connected equipment because automatic UPS shutdown is imminent.

If battery capacity becomes low while on Battery mode:

- The  indicator illuminates solid.
- The audible alarm beeps once every 3 seconds. (This warning is approximate, and the actual time to shutdown may vary significantly.)
- After the UPS shuts down the UPS automatically restarts when utility power is restored (if Auto Restart is enabled).

End of Battery Backup Time

- All the LEDs go OFF.
- The audio alarms stops.

7.4.3 Low Battery Warning

During discharge, the low battery alarm is activated if the remaining runtime goes below 3 minutes or less than the setting capacity threshold (0% by default). This threshold can be modified.

7.4.4 Bypass Mode

Bypass Mode

In the event of a UPS overload or internal failure, the UPS transfers your equipment to utility power. Battery mode is not available and your equipment is not protected; however, the utility power continues to be passively filtered by the UPS. The  indicator illuminates. Depending on overload conditions, the UPS remains in Bypass mode for at least 5 seconds and will stay in this mode if three transfers to bypass occur within one hour.

The UPS transfers to Bypass mode when:

- User or Service activates Bypass mode through the front panel LCD or by using an external bypass switch (BPM or BPE).
- Overload between 105 and 110% for more than 30 seconds
- Overload above 115% for more than 200 msecs
- Output Short
- Hardware fault
- Over Temperature on heatsinks



NOTE 1 **NOTE** Load imbalance between UPMs is <5%

NOTE 2 **NOTE** The UPS shuts down after a specified delay for overload conditions listed above.

7.5 Return of AC Input Power

Following an outage, the UPS restarts automatically when AC input power returns (unless the auto restart function has been disabled) and the load is supplied again.

Setting High Efficiency Mode

In High Efficiency mode, the UPS transfers to Online (or Battery) mode in less than 10 ms when utility fails. Transfers to High Efficiency mode will be active after 5 minutes of Bypass voltage monitoring: if Bypass quality is not in tolerance, then the UPS will remain in Online mode.

To set the High Efficiency mode:

1. Select Settings, In/Out settings, and High Efficiency mode (see [Figure 64](#)).
2. Select Enabled and Enter to confirm.
3. The UPS transfers to High Efficiency mode after 5 minutes.



NOTE If the input is not stable after enabling HE Mode, the UPS will monitor the input for 5 minutes but if it is stable to begin with, it will transfer immediately.

7.6 Configuring Bypass Settings

The following settings are available for configuring Bypass operation (see [Figure 64](#)).

CAUTION

Changing the Bypass settings changes UPS behavior and may result in decreased protection.

Bypass Voltage Min Limit

The default disables a transfer to Bypass if the measured bypass voltage level is below the nominal output voltage -12%. You can configure the setting for another voltage value. This setting can be overruled by the "Protected Bypass" setting.

Bypass Voltage Max Limit

The default disables a transfer to Bypass if the measured bypass voltage level is above the nominal output voltage +12%. You can configure the setting for another voltage value. This setting can be overruled by the "Protected Bypass" setting.

Protected Bypass (Enabled)

Allows a transfer to Bypass only when Bypass is within the following specifications:

- Bypass voltage is between the "Bypass Voltage Low Limit" and "Bypass Voltage High Limit" settings
- Bypass frequency is within 5% of nominal frequency.

Unsynchronized Transfers

When Qualify Bypass is set to "Always" or "Always on Fault" you can select the interruption time when transferring to bypass, default setting is "Half Cycle" but can be changed to "Full cycle".

7.7 Configuring Battery Settings

The following battery settings enable battery tests, alarms and enable auto mode and (see [Figure 66](#)).

7.7.1 Advanced Battery Management

Advanced Battery Management (ABM) extends the life of the battery by shutting off the charger for 28 days per ABM cycle and therefore reduces grid corrosion in the battery caused by trickle charging over long periods of time. Disabling ABM means the battery chargers run in constant charge mode and never turn off. The battery test period is every three ABM cycles.

**NOTE**

It is not recommended to perform a battery discharge test more often than 90 days.

7.7.2 Auto Battery Test

The battery test will run only in Rest Mode and if ABM is enabled. The tests frequency can be modified. During the test, the UPS transfers to Battery mode and discharges the batteries for 25% battery time remaining.

**NOTE**

Battery mode is not displayed and battery low alarm does not activate during a battery test.

The battery test may be postponed due to bad conditions, or failed if battery is not ok.

7.7.3 Low Battery Warning

During discharge, the low battery alarm is activated if the remaining runtime goes below 3 minutes or less than the setting capacity threshold (0% by default). This threshold can be modified.

7.7.4 External Battery Setting

The number of Extended Battery Module is automatically detected, or can be set manually in number of EBM or in Ah.

7.7.5 Deep Discharge Protection

This setting is recommended to avoid damaging the battery. Warranty is void if deep discharge protection is disabled

7.8 Retrieving the Event Log

To retrieve the Event log through the display:

1. Press any button to activate the menu options, then select Event log (see [Figure 70](#)).
2. Scroll through the listed events.
3. Reset event log if desired.

7.9 Retrieving the Fault Log

To retrieve the Fault log through the display:

1. Press any button to activate the menu options, then select Fault log (see [Figure 71](#)).
2. Scroll through the listed faults.
3. Reset fault log if desired.





7.10 Control Panel Operation

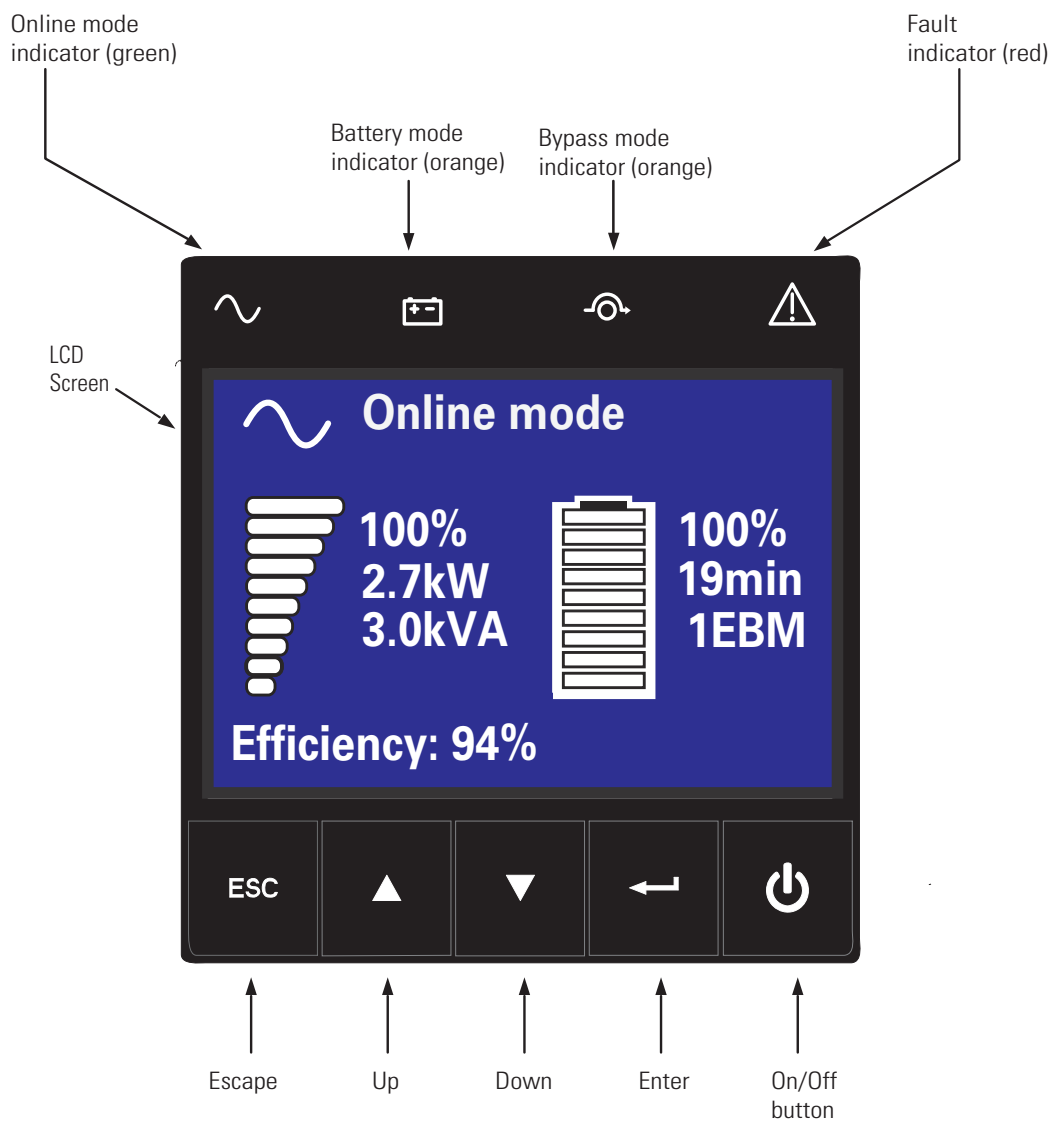

The control panel provides UPS function and control settings.



Figure 56. UPS Control Panel



7.11 Display Functions

Press the Enter () button to activate the menu options. Use the two middle buttons ( and ) to scroll through the menu structure. Press the Enter () button to select an option. Press the ESC button to cancel or return to the previous menu (see Figure 49).

Indicator	Status	Description
 Green	On	The UPS is operating normally on Online or High Efficiency mode.
	On	The UPS is on Battery mode

Indicator	Status	Description
Orange		
 Bypass	On	The UPS is on Bypass mode.
 Red	On	The UPS has an active alarm or fault. See Chapter 11, "Troubleshooting" for additional information.

7.12 LCD Description

After five minutes of inactivity, the LCD displays the screen saver.

The LCD backlight automatically dims after 10 minutes of inactivity. Press any button to restore the screen.



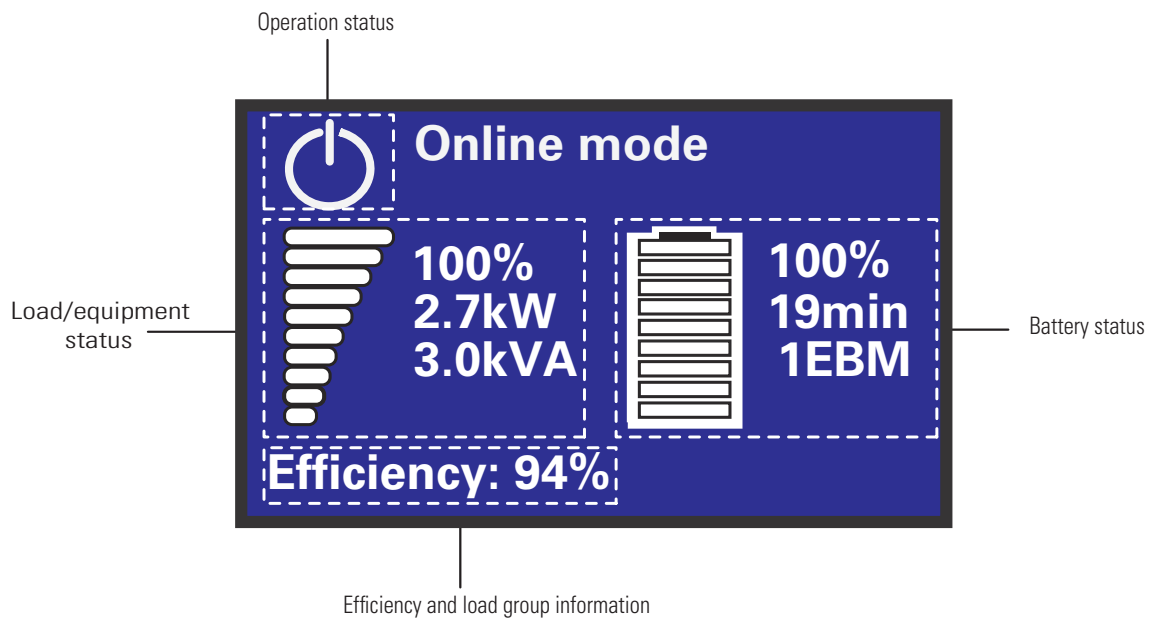





Figure 57. LCD Display Status Indicators



7.13 Display Status Indicators

The following table describes the status information provided by the UPS. If another indicator not shown appears, see, "[11.1 Troubleshooting](#)" for additional information.

Figure 58. Display Status Indicators

Indicator	Status	Description
Standby Mode 	The UPS is Off, waiting for startup command from user. The  indicator flashes continually.	Equipment is not powered until button is pressed.  Green LED blinking when UPS is in Standby mode.
Online Mode 	The UPS is operating normally. The  indicator is on steady.	The UPS is powering and protecting the equipment.
Battery Mode 	A utility failure has occurred and the UPS is on Battery mode.	The UPS is powering the equipment with the battery power. Prepare your equipment for shutdown.
1 beep every 10 seconds		
End of Backup Time 	The UPS is on Battery mode and the battery is running low.	Low Battery Warning settings: [Capacity] [0%]... [100%] [Runtime] [0mn]...[60mn] The alarm triggers when the set percentage of battery capacity or remaining back-up time is reached.
1 beep every 3 seconds		
High Efficiency Mode 	The UPS is operating on High Efficiency mode.	The UPS is powering and protecting the equipment
Bypass Mode 	An overload or a fault has occurred, or a command has been received, and the UPS is in Bypass mode.	Equipment is powered but not protected by the UPS.

7.14 Changing Parameter Settings

The LCD display menus can be selected to show measurements, change control settings and show UPS and event logs. Use the two middle buttons (▲ and ▼) to scroll through the menu screens then press the Enter (←) button to select an option (see [Figure 60](#)).

7.15 Display Menu Screens

Start Screen

The start screen shows the required information at first startup.

Figure 59. Start Screen

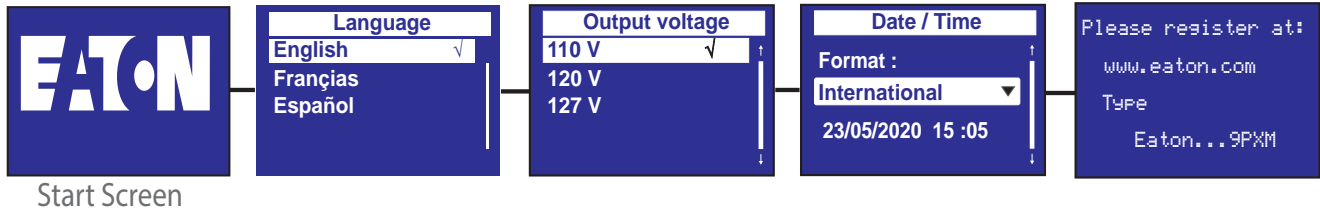

Status Screen

The status screen shows the status of the installed units.

Figure 60. Status Screen Menu

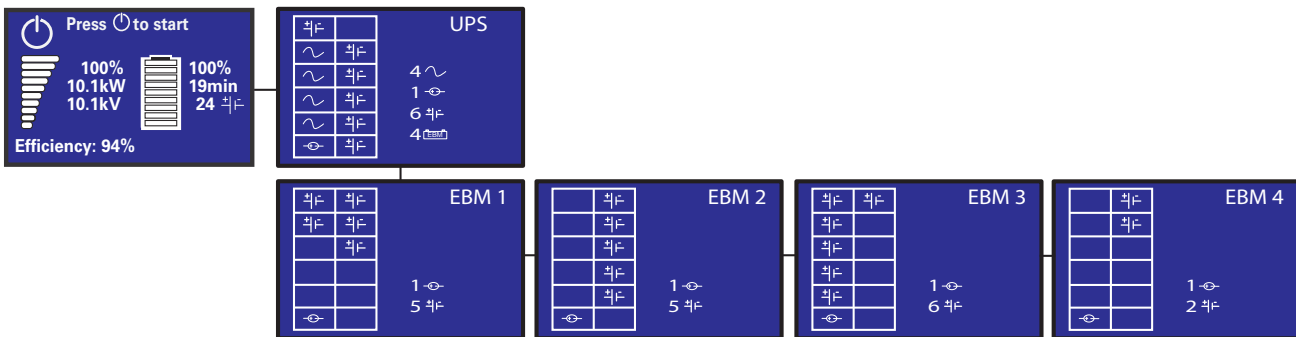

Menu Screen

The Menu Screen selects and controls system features and operating conditions (see Figure 54). Menu items include:

The Menu screen is the main menu and shows the available sub-menus.

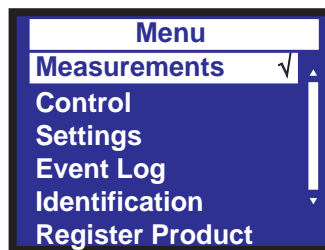

Measurements

The Measurements screen shows the measurements of the installed units.

Figure 61. Measurements Menu

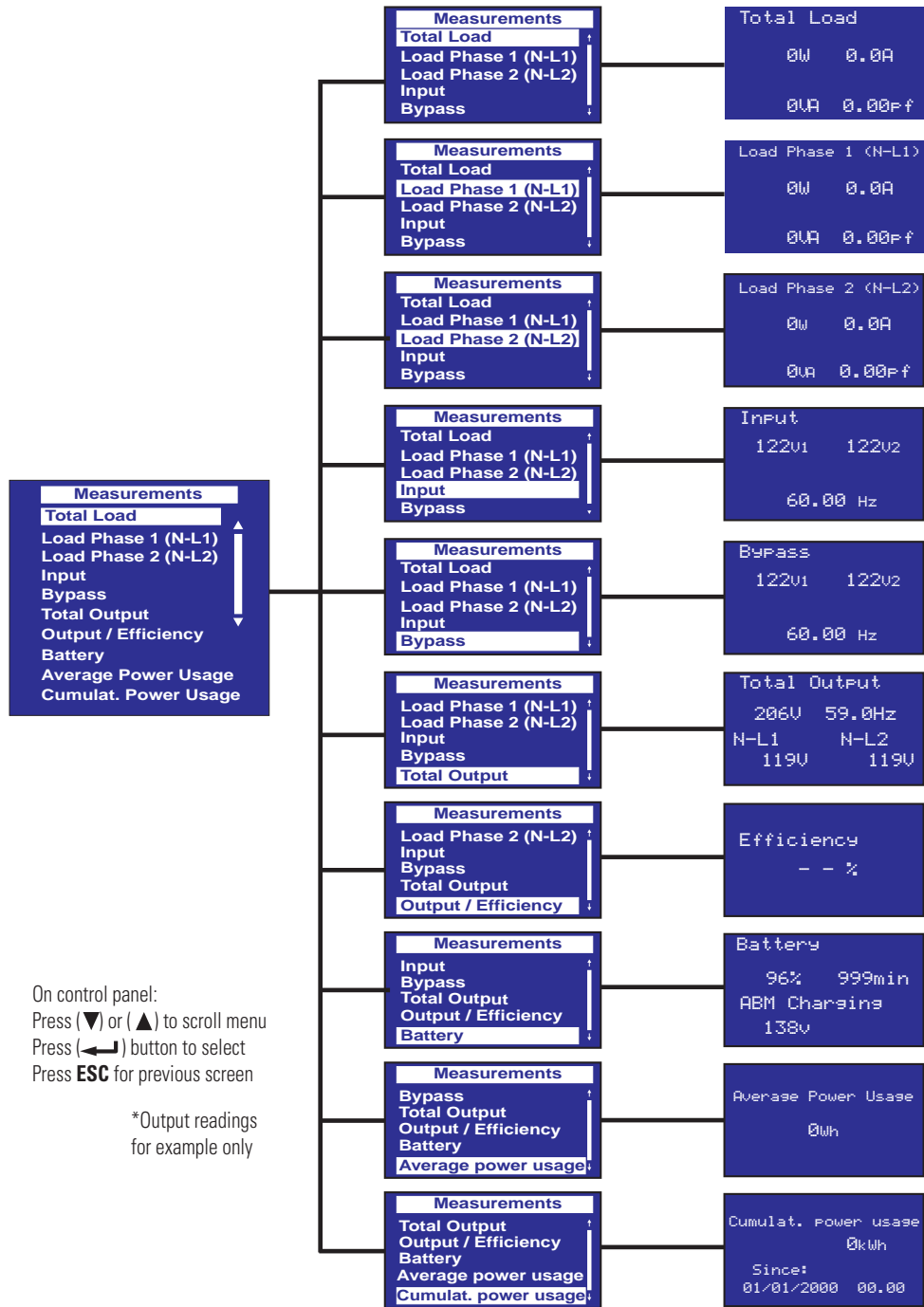

Control

The Control menu provides bypass control and reset of some fault and factory settings.

Figure 62. Control Menu

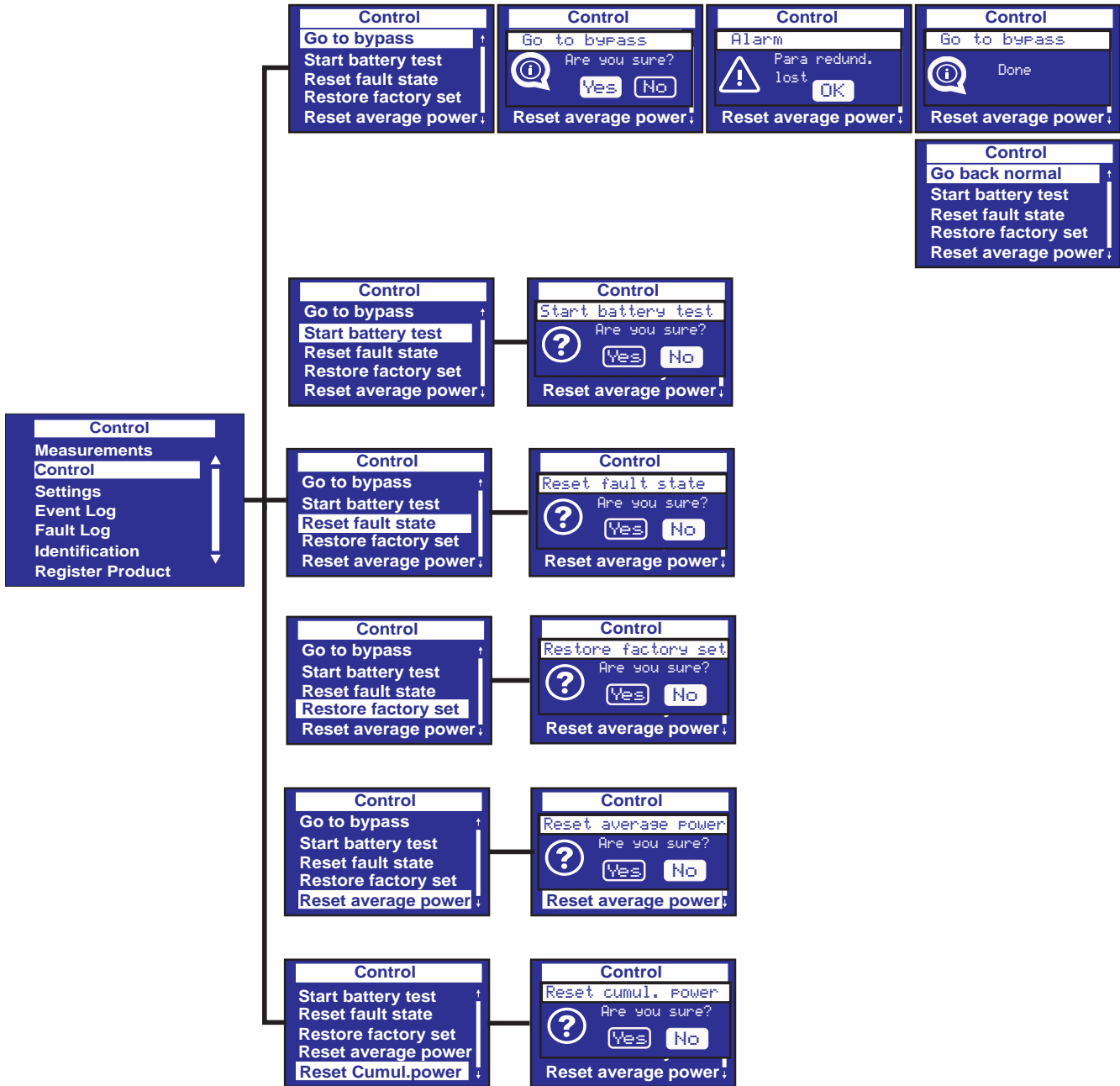

Local Settings

The Settings menus allow the user to modify UPS settings.

Figure 63. Local Setting Menu

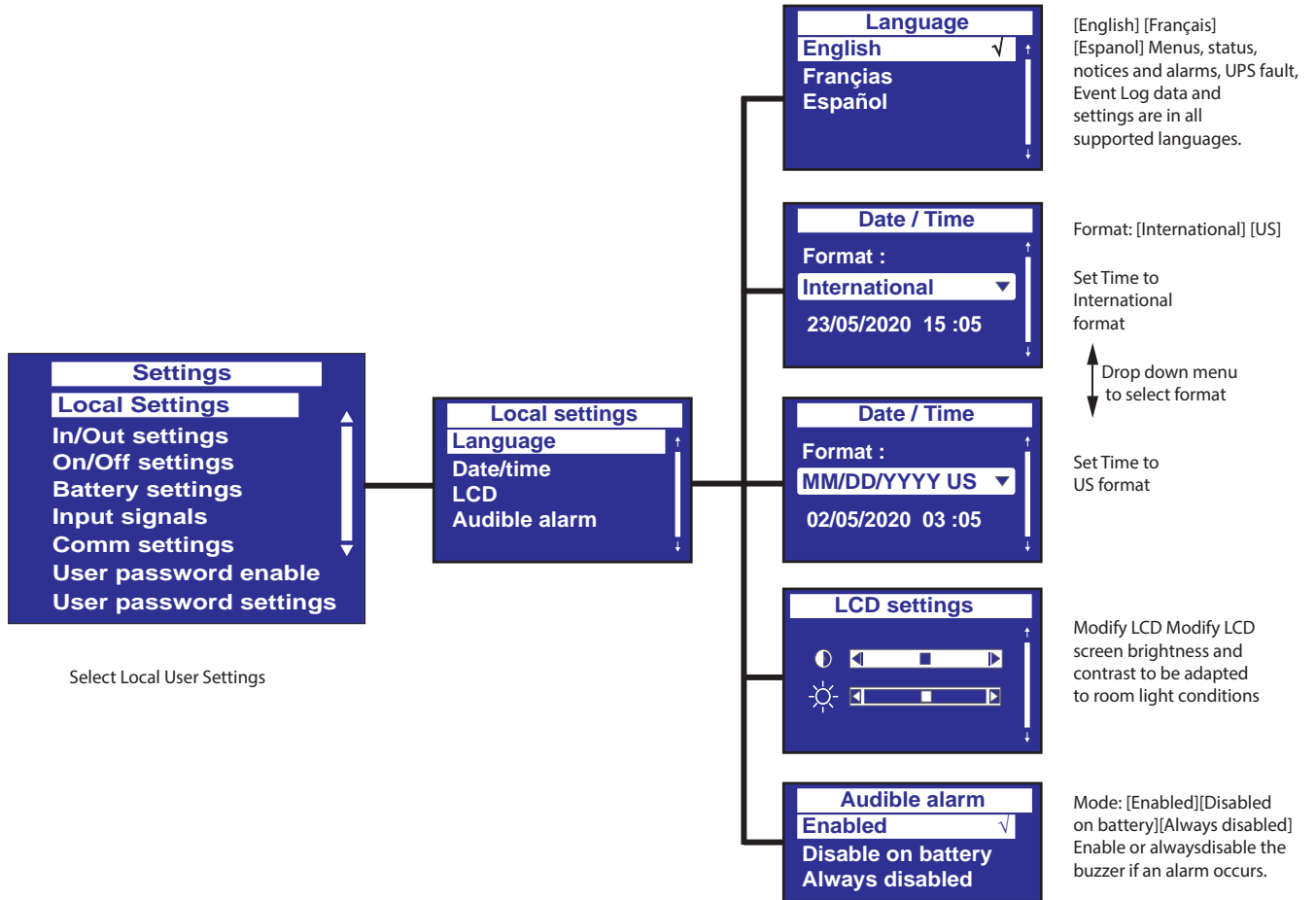

Select Local User Settings

In/Out Settings

The In/Out Settings menus allows control of input and output limits.

Figure 64. In/Out Settings Menu

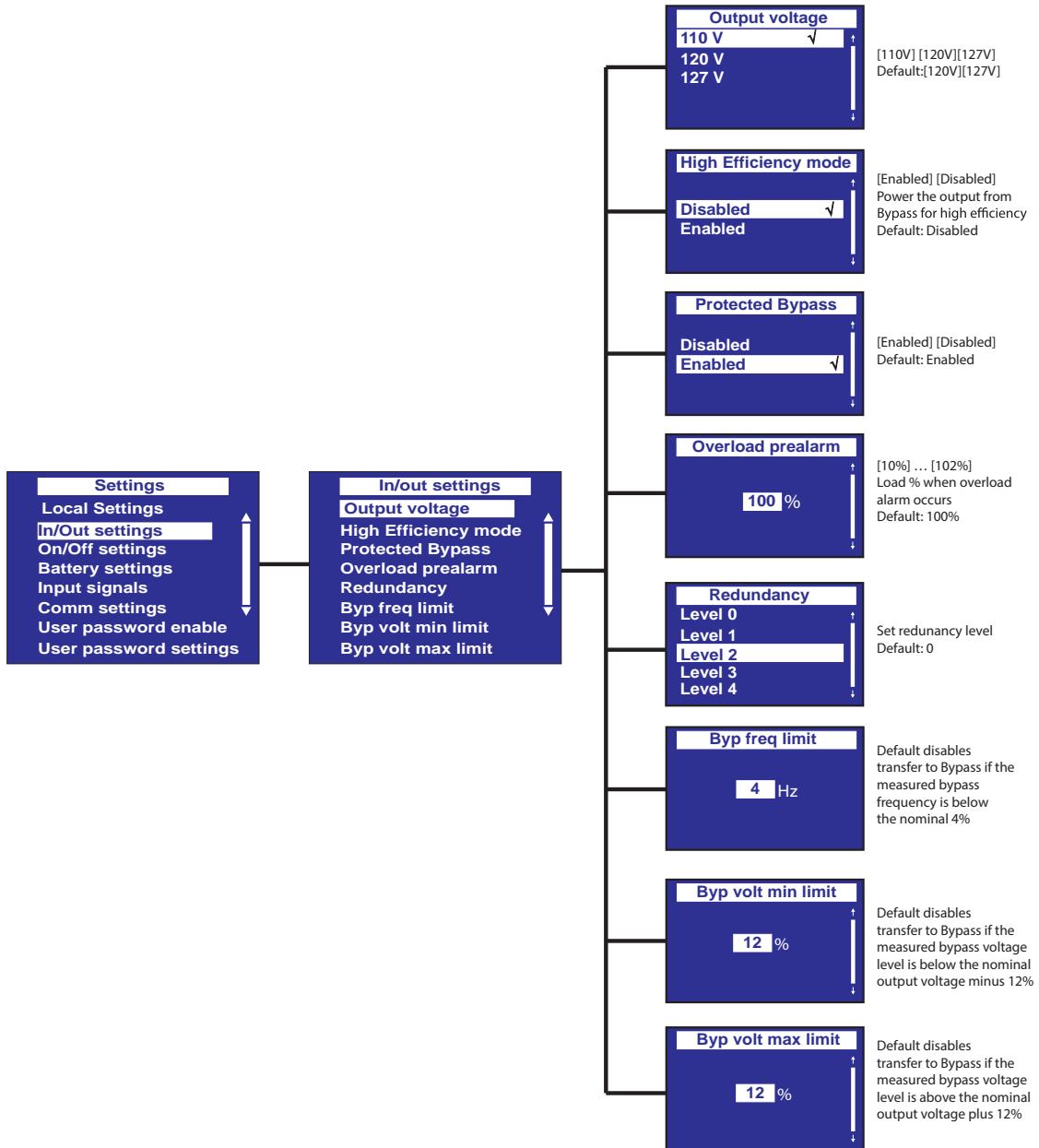

On/Off Settings

The On/Off Settings Menu enables/disables selected automatic restart and shutdown functions.

Figure 65. On/Off Settings Menu

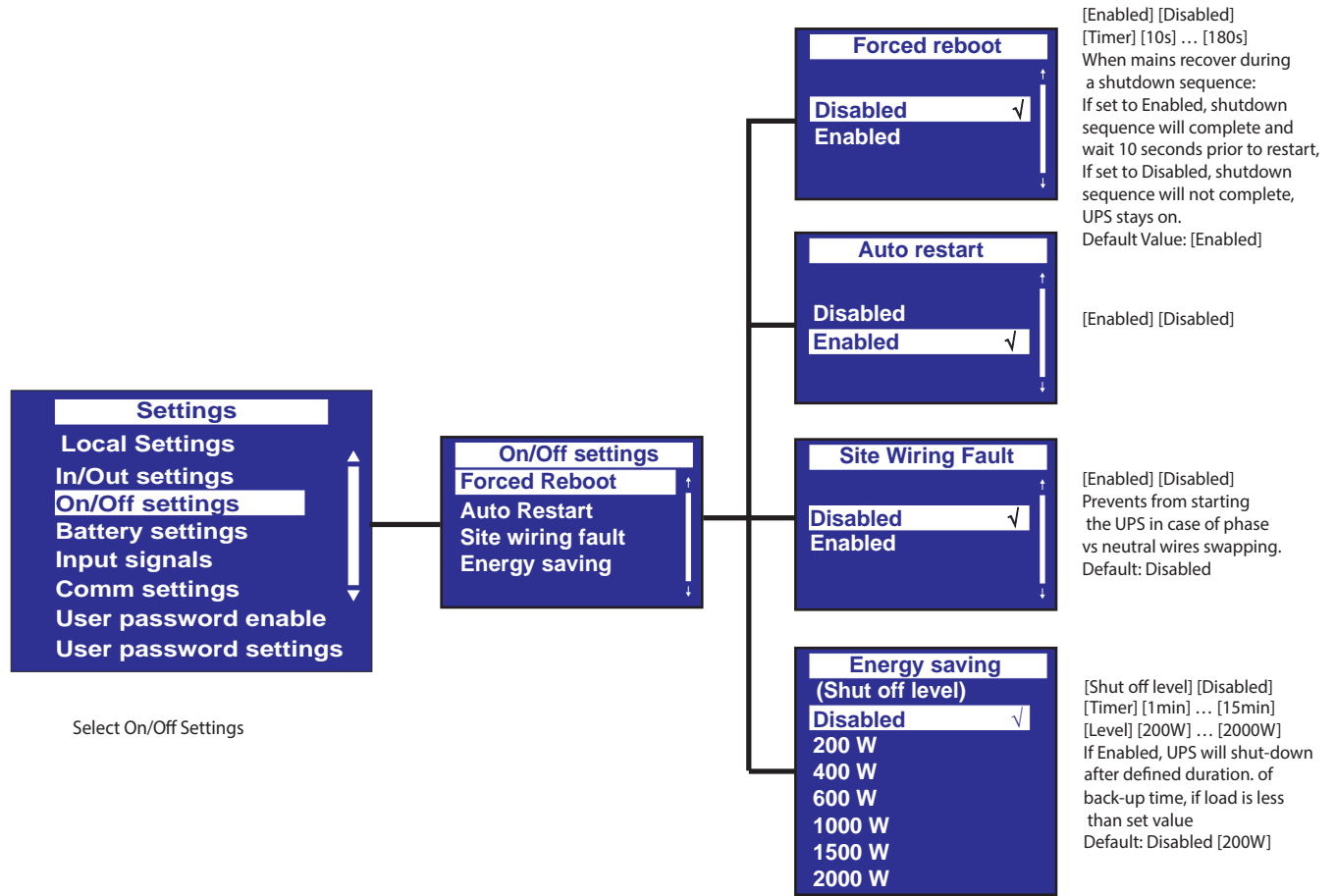

Battery Settings

The Battery Settings Menu provides control of battery tests, warnings and modes.

Figure 66. Battery Settings Menu

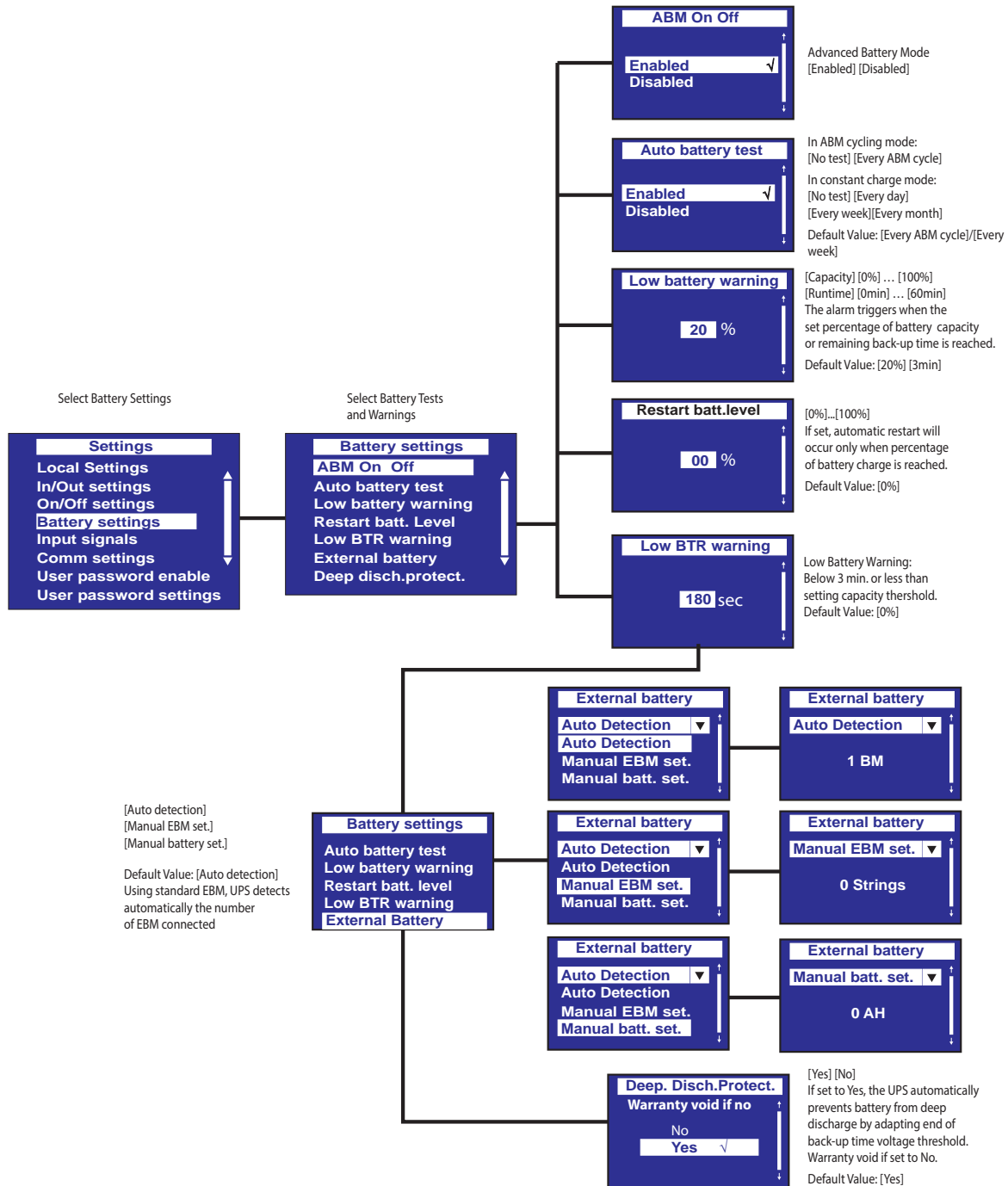

Input Signals

The Input Signals Menu enables/disables power features for the UPS.

Figure 67. Input Signals Menu

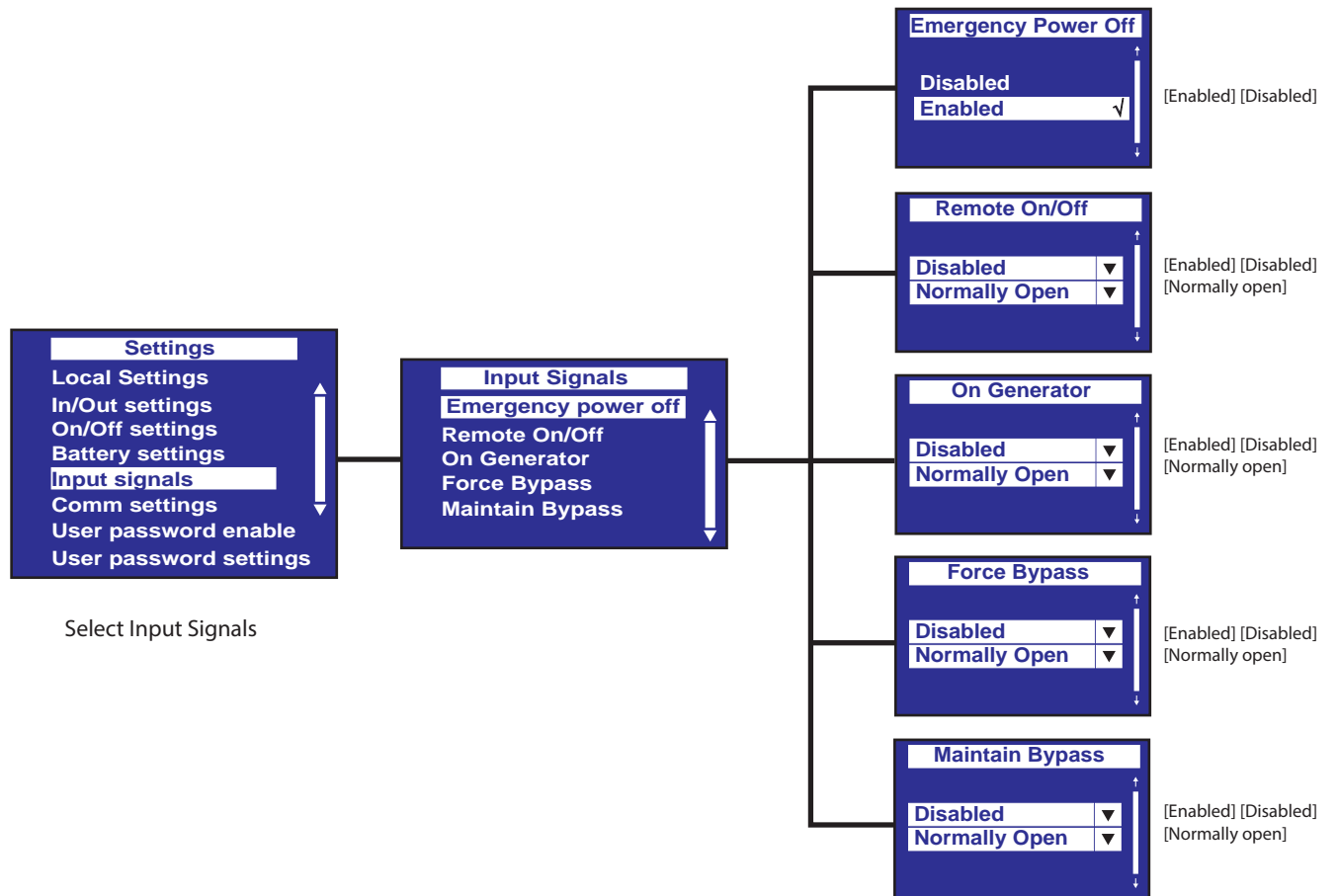

Select Input Signals

Comm Settings

The Comm Settings Menu enables/disables some selected control signal features.

Figure 68. Comm Settings Menu

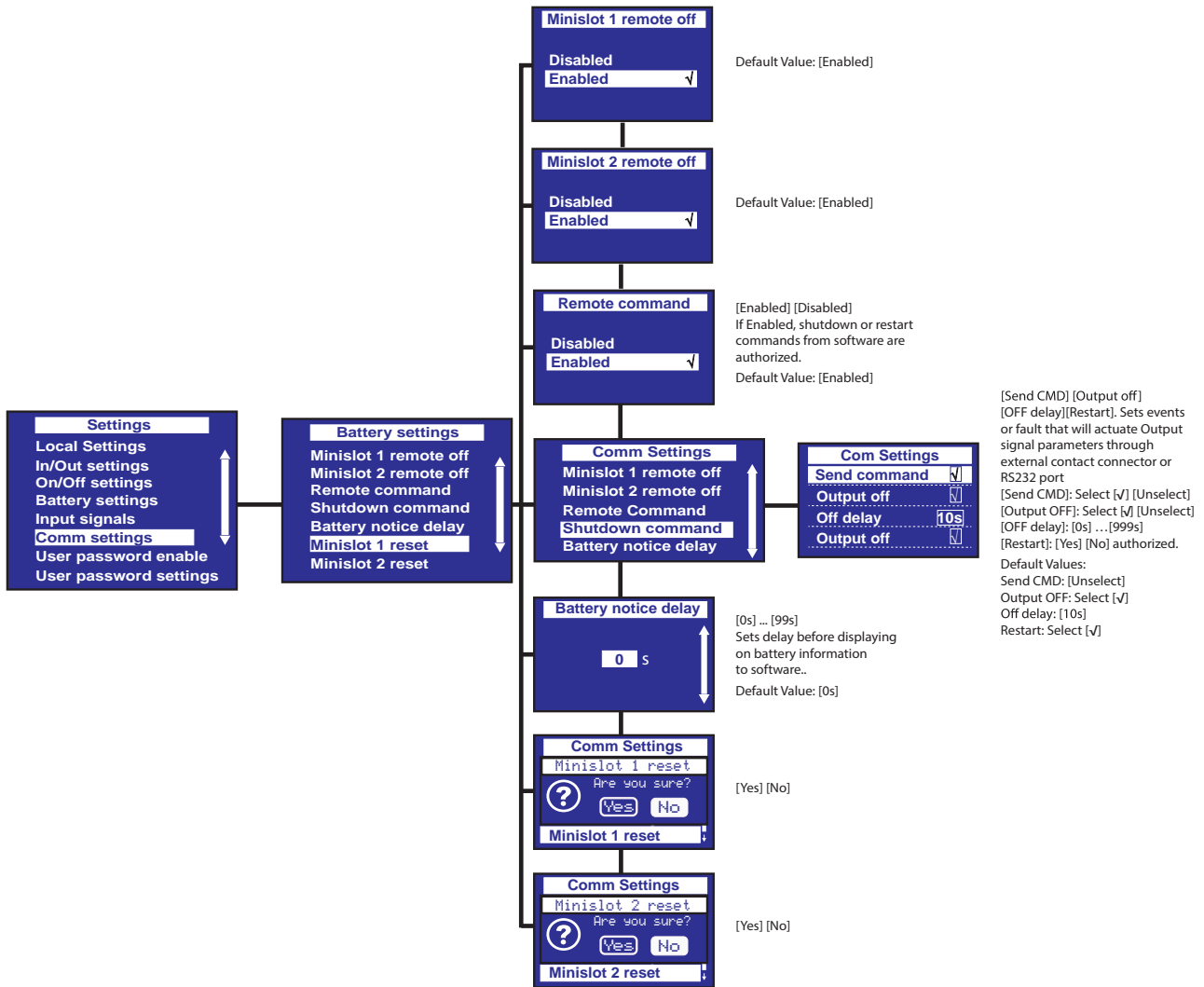

User Password Settings

Figure 69. Password Menus

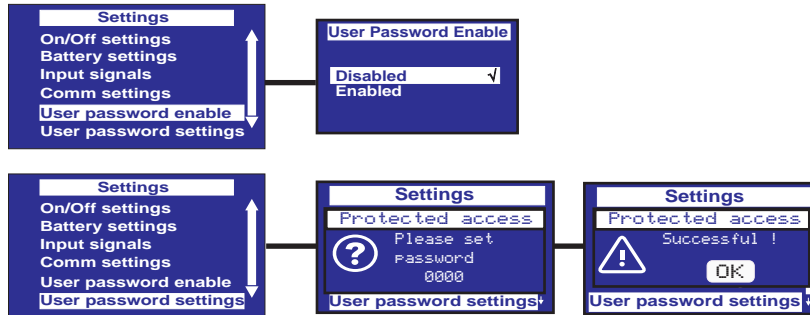

Event Log

Figure 70. Event Log

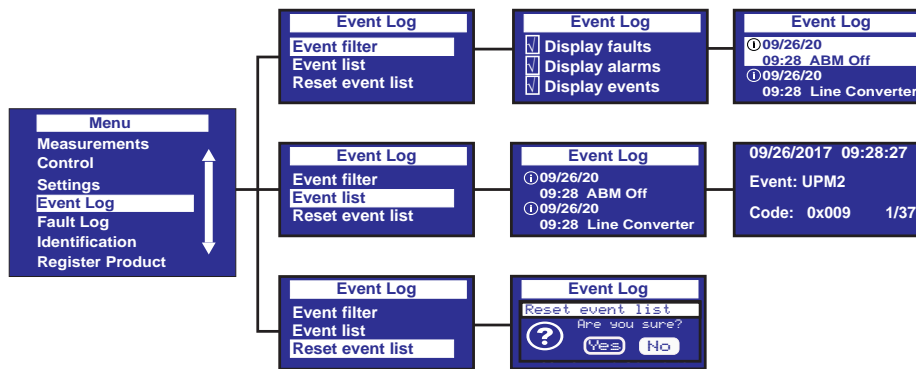

Fault Log

Figure 71. Fault Log Menu

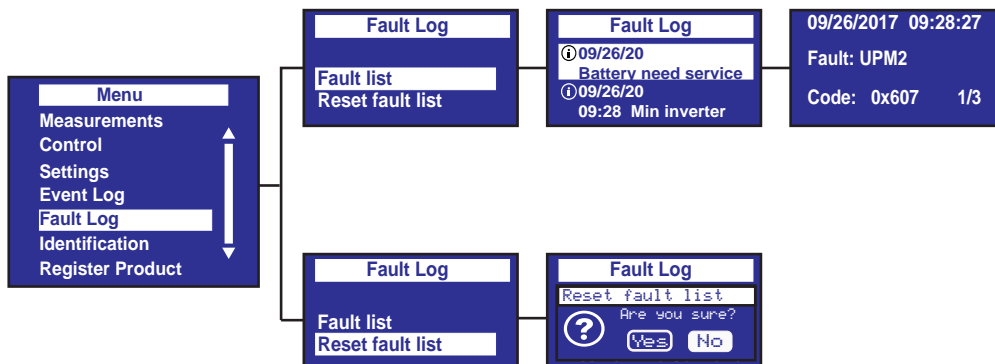

Identification

The Identification screen shows the product type and installed accessories.

Figure 72. Identification Menu

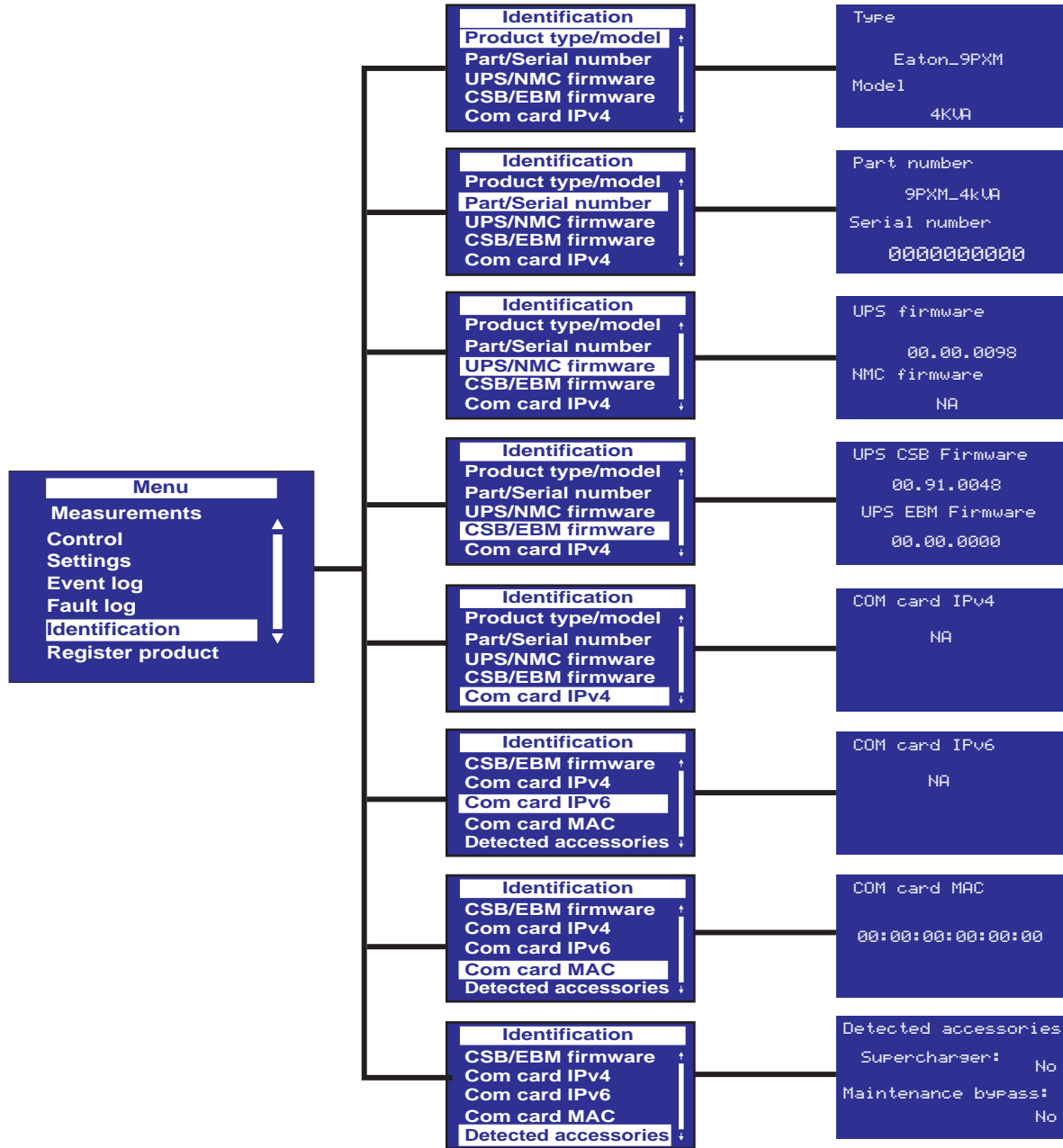

Registration Section

The Register product screen provides directions to register the product with Eaton.

Figure 73. Register Product Menu

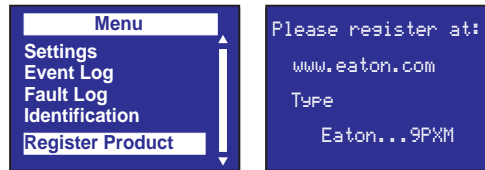

Chapter 8 Communication

8.1 Intelligent Power Manager

Eaton offers several methods of communicating with your Eaton 9PXM system in addition to the front panel display:

- Intelligent Power Manager® (IPM) Power Management Software
- Optional Interface Kits
- Communication ports
- Dedicated Input Signals
- DB-9 Communication Port
- Communication slots

Intelligent Power Manager

Eaton's Intelligent Power Manager (IPM) software provides the tools needed to monitor and manage power devices in a physical or virtual environment. This innovative software solution ensures system uptime and data integrity by allowing the user to remotely monitor, manage and control UPSs and other devices on their network. IPM provides a solution that is easy to use and maintains business continuity.

8.2 Optional Interface Kits

For computer systems that already have UPS monitoring software, Eaton offers interface cable kits for connecting the Eaton 9PXM system to your computer system. The kit includes the cable, adapters, and instructions.

8.3 Communication Ports

Communication Ports

UPS Communications Ports

External communication ports are located on the top rear panel of the UPS (see [Figure 74](#)). They are identified as follows:

- CN6 - ROO and On-Generator signals
- CN5 - Building input signals (for future option)
- Maintenance bypass signals
- EPO
- External slot select signals and External CAN signals, goes to EBM CSB
- DB-9 (RS-232) port
- USB port

Figure 74. UPS Communications Ports

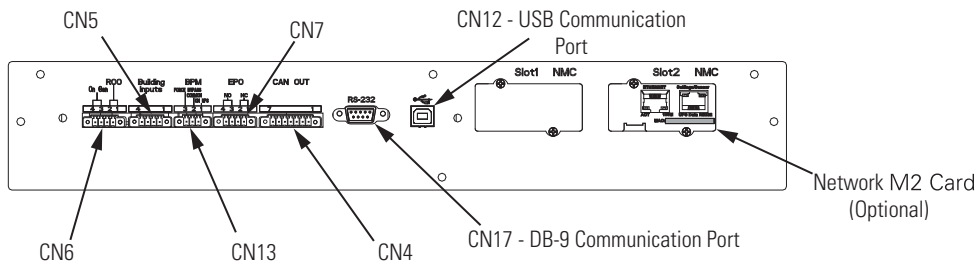

EBM Communication Ports

External communication ports are located on the top rear panel of the EBM (see [Figure 75](#)). They are identified as follows:

- External slot select signals and external CAN signals from UPS
- External slot select external CAN signals to next EBM
- Last EBM Jumper
- DB-9 (RS-232) port
- USB port

Figure 75. EBM Communication Port

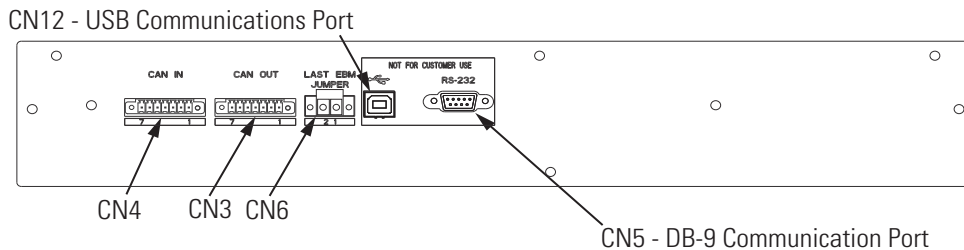

Refer to detail A in for the type of signal connectors used.

8.4 Dedicated Input Signals

Dedicated Input Signals

Emergency Power-off (EPO): Connection to a facility Emergency Shutdown switch provides a method for emergency Eaton 9PXM system shutdown.

EPO Connections

In the 9PXM UPS, EPO can be configured either as Normally Open (NO) or Normally Closed (NC) contacts. Connector CN7 on the rear panel of the UPS is used for EPO.

NO Configuration

For Normally Open operation, configure as in [Figure 76](#) with external switch wired to Pins 3 and 4 of CN7. 18AWG Twisted wire is to be used for EPO connections.

Figure 76. Normally Open Connections

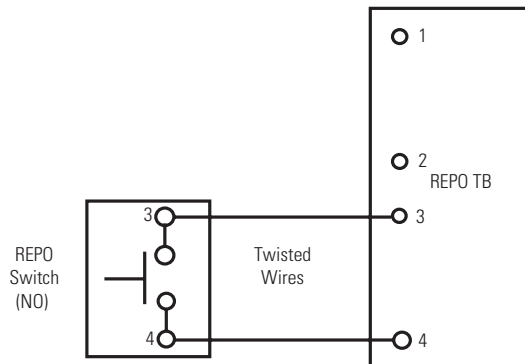

- NOTE** REPO switch rating is 24 Vdc. 1A minimum
- NOTE** The REPO switch must be a latching type switch not tied to any other circuits.

NC Configuration

For Normally Closed operation, add a jumper between Pins 3 and 4 of CN7 and the EPO switch should be connected to Pins 1 and 2 and should be closed during normal operation of the UPS (see [Figure 77](#)).

Figure 77. EPO Normally Closed Connections

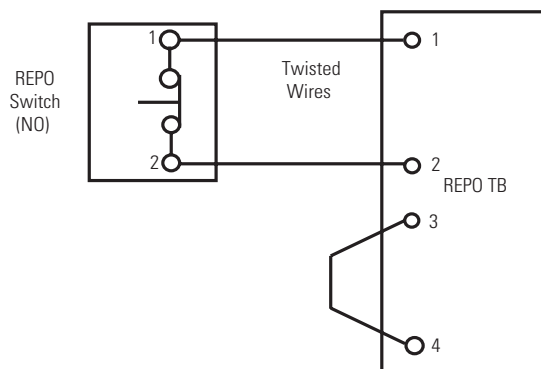

- NOTE** REPO switch rating is 24 Vdc. 1A minimum
- NOTE** The REPO switch must be a latching type switch not tied to any other circuits.

Maintenance Bypass: The signal from an external bypass switch, to isolate the Eaton 9PXM system for maintenance purposes, tells the UPS to go into Internal Bypass mode.

On Generator: The signal allows the UPS to optimize its operation with the generator by transferring the UPS from High Efficiency mode to Normal (double conversion) mode as long as High Efficiency is set as the default mode of UPS operation. See IN/Out setting.

8.5 DB-9 Communication Port

Table 7 explains the functions of the pins on the Eaton 9PXM DB-9 communication port. This port is on the Eaton 9PXM UPS rear panel, as shown in [Figure 75](#).

Pin	Function	Description
1	Low Battery Alarm	Pin 1 shifts from RS-232 Low (negative voltage) to RS-232 High (positive voltage) and remains high whenever the UPS enters a Low Battery alarm state.
2	RS-232 Transmit Data	Sends outgoing RS-232 communication data at 9600 baud, 8 bits, no parity, 1 stop bit.
3	RS-232 Receive Data/ RS-232 Shutdown	RS-232 Receive Data Function. Receives incoming RS-232 communication data at 9600 baud, 8 bits, no parity, 1 stop bit. RS-232 Shutdown Function. If Pin 3 receives an RS-232 Low signal (+Vdc) for at least 5 seconds, but not more than 7 seconds, during an AC Failure condition, the UPS output shuts off following a delay of 120 seconds (± 5 seconds).
4	Reserved	Loopback to Pin 6
5	Common	Signal Ground
6	Reserved	Loopback to Pin 4
7	No Connection	Open Pin
8	AC Fail Signal (On-Battery)	Pin 8 shifts from RS-232 Low (positive voltage) to RS-232 High (positive voltage) and remains high for 15 seconds (± 1 second) after the UPS detects an AC Failure condition, assuming the condition still exists after the 15 seconds. When the AC Failure condition no longer exists, the signal returns to the RS-232 Low state (positive voltage).
9	No Connection/ DC Supply Voltage	The UPS is factory-set with Pin 9 disconnected, but can be enabled through a technician-replaceable jumper inside the UPS. The jumper setting MUST be changed by a qualified service technician. When enabled, Pin 9 provides supply voltage for use with external connectivity devices requiring DC power directly from the UPS DB-9 port (nominal 12 Vdc/5W; 8V minimum, 24V maximum). Use only Eaton brand connectivity devices.

8.6 Communication Slots

The Eaton 9PXM UPS has two communication slots that allow quick installation of the optional communication cards. These interface cards extend the capabilities of the Eaton 9PXM system to provide compatibility with network and remote monitoring/management systems.

Type of connectivity cards that can be installed include:

Network Card M-2

The Eaton Network Card-M2 allows an Eaton UPS to directly connect to the Ethernet network and the Internet, supporting real-time monitoring and control of UPSs across the network via a standard Web browser, SNMP-compliant network management system or power management software. Environmental monitoring is also possible via an Environmental Monitor Probe (EMP)

Network and Modbus Card MS

The Eaton Network and MODBUS Card-MS provides continuous, reliable and accurate remote monitoring of a UPS system through a Building Management System (BMS) or Industrial Automation System (IAS). Enabling data to be integrated from the UPS into a wide variety of management systems, the MODBUS Card-MS combines an SNMP agent, HTTP/Web server and a MODBUS card, facilitating UPS supervision from any network monitoring system using SNMP and traps, or any web browser.



Relay Card—MS

The Eaton Relay Card-MS enables automatic shutdown and network monitoring of UPS system status through a connected computer with a dedicated adapter that provides the essential dry-contact interface between an Eaton UPS and any relay-connected computer as well as a variety of industrial applications. The Relay Card-MS is compatible with all Eaton UPSs that have a Minislot.

Chapter 9 Maintenance

9.1 Routine Maintenance

This chapter provides maintenance information to help maintain proper UPS operation.

-
- | | |
|---|---|
|  | NOTE 1 Observe important safety precautions while performing these checks. |
|  | NOTE 2 Eaton recommends that you schedule preventive maintenance checks at least every six months. |
-

The Eaton 9PXM system is designed to provide years of trouble-free operation. Its internal control system checks the batteries and inverter periodically to ensure reliable operation.

The Eaton 9PXM UPS and optional external battery cabinets do require some attention to assure continued reliable service. Follow Eaton's recommended maintenance schedule, which includes:

- Check operating environment for clean, cool, dry conditions.
- Inspect and clean the area around the UPS
- Check operation of fans (power modules).
- Check the batteries.

For more information on preventive maintenance checks, contact your service representative.

9.2 Storage Temperature

Store the Eaton 9PXM battery modules (in the UPS or external battery cabinet) at -20 to $+40^{\circ}\text{C}$ (-4 to $+104^{\circ}\text{F}$). Batteries will have a longer shelf life if they are kept below $+25^{\circ}\text{C}$ ($+77^{\circ}\text{F}$). The Eaton 9PXM UPS or battery cabinet without batteries may be stored at -40 to $+60^{\circ}\text{C}$ (-40 to $+140^{\circ}\text{F}$).

9.3 External Bypass Switch (Make Before Break Only) Operation

Press the red button beside the switch before turning the Eaton MBB bypass switch. This button:

- Sends an electrical signal to the UPS to switch to the internal Bypass mode (if it is not already operating in that mode).
- Operates a mechanical interlock, to prevent the switch from being turned without first signaling the UPS.

⚠ WARNING

Failure to understand the correct bypass sequence and position may cause the critical load to be dropped. Damage to the power modules or the Bypass switch can occur.

- If the UPS remains in Bypass Mode and incoming AC power is lost, the load is automatically dropped. The UPS must be in Normal Mode to provide battery backup power.
- In the UPS or LINE position, AC input power is still connected to the input terminals inside the UPS.
- **If the UPS is in the standby mode and the bypass switch is in the LINE or UPS positions pressing the red bypass switch interlock button will energize the UPS output.**
- **Do not attempt to push the red interlock button or attempt to move the bypass switch handle if the UPS is operating on battery power.**
- If you have any questions or problems with the bypass operation, call the Help Desk (see , "[11.2 Service and Support](#)").

See "[3.6 Bypass Overview](#)" for additional information.

9.4 Battery Replacement

The Eaton 9PXM hot-swappable feature lets you replace the battery modules without disconnecting the load or damaging the batteries.



NOTE The Eaton 9PXM UPS will operate with uncharged (or no) batteries, but will have limited (or no) battery backup capability. The UPS will indicate an alarm with a insufficient number of batteries present. One battery string (two battery modules) must be installed adjacent to each power module.

To replace a two-battery slot in pairs:

1. Remove the front cover.
The cover has magnetic latches on the left and right sides that hold it in place.
2. Loosen the captive screw on the retaining bracket and slowly pull the upper battery module out of the cabinet.
3. Repeat the procedure with the lower battery module.
4. Treat the original and replacement battery modules with care to avoid damaging connectors or internal circuitry. Label the original batteries with masking tape or some other identifier. Record the serial number of the replacement modules for your warranty.
5. Insert the replacement battery modules by sliding the lower module carefully into the cabinet. Repeat for the upper replacement module.
6. Reinstall the retaining bracket and tighten the captive screw.
7. Replace the front cover.

Figure 78. Battery Replacement

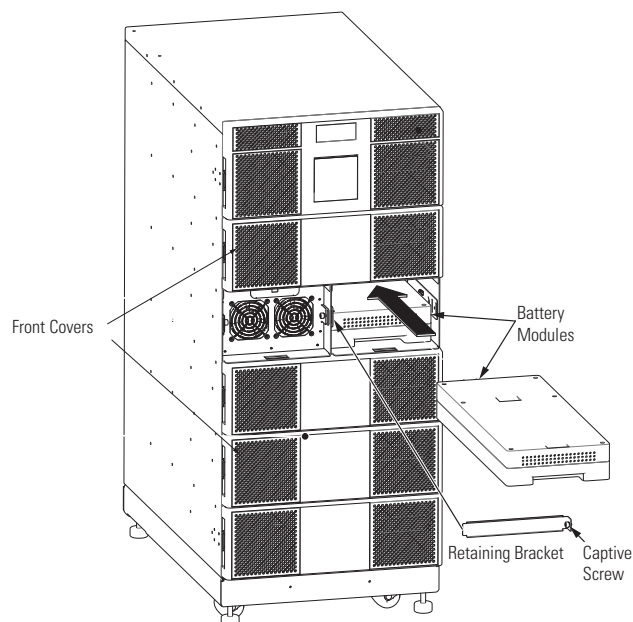

9.5 Power Module Replacement

The Eaton 9PXM easy replace feature lets you replace a power module without disconnecting the load or damaging the UPS.



NOTE

The UPS may switch to internal Bypass mode if the remaining power modules are insufficient to supply the required power. If empty slots exist, install replacement modules before removing original ones.

Use care in removing and installing power modules. To remove a power module:

1. Remove the front cover.

The cover has magnetic latches on the left and right sides that hold it in place.
2. Loosen the captive screws at the sides of the power module and slowly pull the power module out of the cabinet.
3. Treat the original and replacement power modules with care to avoid damaging connectors or internal circuitry. Label the original power modules with masking tape or some other identifier. Record the serial number of the replacement power modules for your warranty.
4. Insert the replacement power module by sliding it carefully into the cabinet.
5. Tighten the captive screws to the UPS cabinet.
6. Replace the front cover.

Figure 79. Power Module Replacement

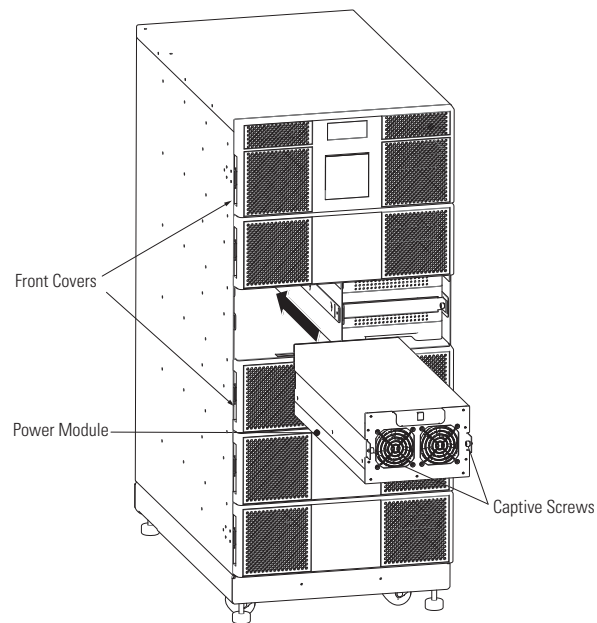

9.6 UPS Firmware Upgrade



IMPORTANT

To ensure you have the most up-to-date content and information for this product, please review the latest manual revision on our website, <https://www.eaton.com/9PXM>

FW upgrade program and instructions are located at the following web link: <https://www.eaton.com/9PXM>.

Chapter 10 Specifications

10.1 Nominal Electrical Input and Output

This section provides the following specifications for the Eaton 9PXM models:

- Nominal Electrical Input and Output
- Combined UPM Power Ratings
- Circuit Breakers
- Environmental and Safety
- Battery
- Output Run Times
- Weights and Dimensions

Table 7. Electrical Input and Output

Nominal Input Voltage	110/220, 120/208, 120/240, 127/220 Vac
Input Voltage Range	80V–144V (Line neutral)
Nominal Output Voltage	110/220, 120/208, 120/240, 127/220 Vac
Nominal Frequency	Online: 60 Hz auto-sensing; output frequency tracks input frequency to selectable limit (± 0.1 to ± 5.0 Hz; ± 3.0 Hz default); switches to battery operation outside this tolerance On battery: 60 Hz ± 0.1 Hz
Regulation	$\pm 5\%$ load regulation (under any line, load, or battery condition)
Voltage Waveform	Sine wave; $< 5\%$ THD at rated linear loads, computer-grade power
Overload Capability	115% for 3 seconds; $> 115\%$ for 12 cycles
DC Input Protection	DC fuse
Output Protection	Microprocessor-sensed overvoltage and overcurrent, with fuse backup
Efficiency in Double-Conversion mode	$> 93\%$

10.2 Combined UPM Power Ratings

Table 8. Power Ratings

Combined UPS Ratings	Split Phase Voltage L-N/L-L	Max Input Current/Phase	Output Current L-N*	Input Service	Heat Dissipation — Normal Mode
4KVA, 3600 Watts (1UPM)	120/208V or 240V	20	16.67A/phase	25A	850 BTU/hr
8KVA, 7200 Watts (2 UPMs)	120/208V or 240V	40	33.34A/phase	50A	1700 BTU/hr
12KVA, 10800 Watts (3 UPMs)	120/208V or 240V	60	50.01A/phase	75A	2500 BTU/hr

Table 8. Power Ratings (Continued)

Combined UPS Ratings	Split Phase Voltage L-N/L-L	Max Input Current/Phase	Output Current L-N*	Input Service	Heat Dissipation — Normal Mode
16KVA, 14400 Watts (4 UPMs)	120/208V or 240V	80	66.68A/phase	100A	3400 BTU/hr
20KVA, 18000 Watts (5 UPMs)	120/208V or 240V	100	83.35A/phase	125A	4250 BTU/hr

*Note: Relative to output load factor, for 120V L to N current

10.3 Circuit Breakers

Circuit Breakers

Table 9. Circuit Breaker Sizes

Required Input Circuit Breaker Sizes	
UPS Capacity	Input Circuit Breaker
4kVA	25A
8kVA	50A
12kVA	75A
16kVA	100A
20kVA	125A

10.4 Environmental and Safety

Table 10. Environmental and Safety

Operating Temperature	0°C to 40°C (32°F to 104°F) Optimal battery performance: 25°C (77°F)
Storage Temperature	UPS with battery modules: -20°C to +40°C (-4°F to 104°F) UPS without batteries: -40°C to +60°C (-40°F to 140°F)
Relative Humidity	5–95% noncondensing
Operating Altitude	Up to 3,050 meters above sea level (10,000 ft) The maximum operating ambient temperature decreases 1°C per 300m above 1525m (2°F per 1000 ft above 5000 ft)
Non-Operating Altitude	Up to 12,200m above sea level (40,000 ft)
Ventilation	The air around the UPS must be clean and free of dust, corrosive chemicals, and other contaminants. The Eaton 9PXM UPS uses internal fans to circulate the air for cooling. The air must be free to circulate around the UPS and battery cabinet(s). Do not operate the UPS in a sealed room or container.
Audible Noise	Less than 67 dBA

Table 10. Environmental and Safety (Continued)

Surge Suppression	EN 61000-4-5
Safety Conformance	CSA C22.2, No. 107.3; UL1778 5th Edition
Agency Markings	NOM, UL, CUL, FCC
EMC (Class A)	EN 62040-2, FCC Part 15, EN 61000-4-2 level 3 Criteria B, EN 61000-4-3 level 3 Criteria A, EN 61000-4-4, 61000-4-5, 61000-4-6, 61000-4-8

10.5 Battery Ratings

Table 11. Battery Ratings

Configuration	(2) 60V, 9 Ah battery modules per two-battery slot
Voltage	120 Vdc
Type	Sealed, maintenance-free, valve-regulated, lead-acid
Charging	ABM recommends 48 hours of charging after a discharge. Optional super chargers at higher current ratings are available.

10.6 Output Run Times

Model	Nominal Output Voltage (VAC) L-N /L-L	Output VA/W Rating @ Nominal	Input Connection	Output (See Output Receptacles Figure 74)	Minimum Run time at full power load**
Split-Phase 20kVA 12-Slot	110/220	18000/16200	Hardwired	Hardwired + Optional Receptacles	5.8 min
	120/208	20000/18000			
	120/240	20000/18000			
Split-Phase 16kVA 8-Slot	110/220	16000/14400	Hardwired	Hardwired + Optional Receptacles	5.8 min
	120/208				
	120/240				

10.7 Weights and Dimensions

Table 12. Weights and Dimensions

Cabinet Size	Package Height	Package Length	Package Width	Package Weight	Product Height	Product Length	Product Width	Product Weight	With Caster Tray (lbs)
12 Slot UPS	118.1 cm (46.5")	88.9 cm (35")	64.1 cm (25.25")	110.7 kg (244 lb)	92.7 cm (36.5")	87.6 cm (34.5")	44.5 cm (17.5")	77.1 kg (170 lb)	93.4 kg (206 lb)
8 Slot UPS	88.9 cm (35")	88.9 cm (35")	64.1 cm (25.5")	90.3 kg (199 lb)	63.5 cm (25")	87.6 cm (34.5")	44.5 cm (17.5")	56.7 kg (125 lb)	73 kg
									(161 lb)
12 Slot EBM	118.1 cm (46.5")	88.9 cm (35")	64.1 cm (25.5")	108.5 kg (239 lb)	92.7 cm (36.5")	87.6 cm (34.5")	44.5 cm (17.5")	74.8 kg (165 lb)	91.2 kg (201 lb)

Table 12. Weights and Dimensions (Continued)

8 Slot EBM	88.9 cm (35")	88.9 cm (35")	64.1 cm (25.5")	88 kg (194 lb)	63.5 cm (25")	87.6 cm (34.5")	44.5 cm (17.5")	54.4 kg (120 lb)	70.8 kg (156 lb)
Battery Module	16.5 cm (6.5")	64.8 cm (25.5")	30.5 cm (12")	15.9 kg (35 lb)	7.6 cm (3")	54.6 cm (21.5")	21.6 cm (8.5")	15 kg (33 lb)	N/A
Split Phase Power module	29.2 cm (11.5")	68.6 cm (27.5")	38.1 cm (15")	15.4 kg (34 lb)	15.2 cm (6")	58.4 cm (23")	21.6 cm (8.5")	12 kg (26.5 lb)	N/A
Super Charger	29.2 cm (11.5")	68.6 cm (27.5")	38.1 cm (15")	12.5 kg (27.5 lb)	15.2 cm (6")	58.4 cm (23")	21.6 cm (8.5")	10.2 kg (22.5 lb)	N/A
Rail Kit	26.7 cm (10.5")	101.6 cm (40")	61 cm (24")	27.4 kg (60.5 lb)	14 cm (5.5")	58.4 cm (23")	49.5 cm (19.5")	15.6 kg (34.5 lb)	N/A
Caster	25.4 cm (10")	101.6 cm (40")	61 cm (24")	28.1 kg (62 lb)	12.7 cm (5")	73.7 cm (29")	50.8 cm (20")	16.3 kg (36 lb)	N/A
Floor anchor kit	20.3 (8")	25.4 cm (10")	15.2 kg (6")	4.1 kg (9 lb)	12.7 cm (5")	12.7 cm (5")	7.6 cm (3")	3.6 kg (8 lb)	N/A

10.8 Output Receptacles

Figure 74 shows the types of compatible output receptacles.

Figure 80. Compatible Output Receptacles

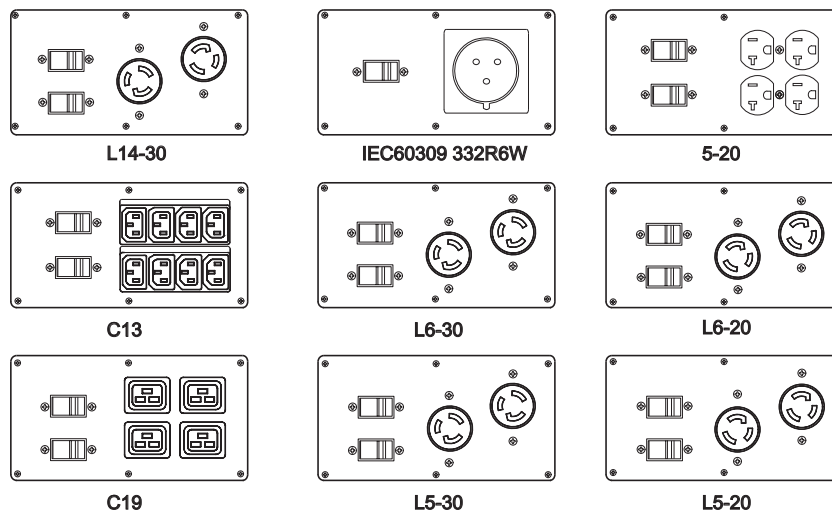

10.9 Receptacle Circuit Breaker Ratings

Table 13. Receptacle Circuit Breaker Ratings

Receptacle Panel	Circuit Breaker	Quantity per Panel
20-May	1 Pole 20 Amp	2
IEC60309	2 Pole 30 Amp	1
C13	2 Pole 20 Amp	2
C19	2 Pole 30 Amp	2
L14-30	2 Pole 30 Amp	2
L5-20	1 Pole 20 Amp	2
L5-30	1 Pole 30 Amp	2
L6-20	2 Pole 20 Amp	2
L6-30	2 Pole 30 Amp	2

Receptacle Circuit Breaker Ratings

Chapter 11 Troubleshooting

11.1 Troubleshooting

The Eaton 9PXM is designed for durable, automatic operation and also alert you whenever potential operating problems may occur. Usually the alarms shown by the control panel do not mean that the output power is affected. Instead, they are preventive alarms intended to alert the user.

- Events are silent status information that are recorded into the Event log. Example = "AC freq in range".
- Alarms are recorded into the Event log and displayed on the LCD status screen with the logo blinking. Some alarms may be announced by a beep every 3 seconds. Example = "Battery low".
- Faults are announced by a continuous beep and red LED, recorded into the Fault log and displayed on the LCD with a specific message box. Example = Out. short circuit.
- Use the following troubleshooting chart to determine the UPS alarm condition.

Typical Alarms and Faults

To check the Event log or Fault log:

1. Press any button on the front panel display to activate the menu options.
2. Press the down arrow button to select Event log or Fault log from the Menu screen.
3. Scroll through the listed events or faults. See [7.8 Retrieving the Event Log](#) and [7.9 Retrieving the Fault Log](#)

The following table describes typical conditions.

Table 14. Typical Alarm Conditions







	Possible Cause Conditions	Action
Battery Mode  LED is On 1 beep every 10 seconds	A utility failure has occurred and the UPS is on Battery mode.	The UPS is powering the equipment with the battery power. Prepare your equipment for shutdown.
Battery low  LED is On 1 beep every 3 seconds	The UPS is in Battery mode and the battery is running low.	This warning is approximate, and the actual time to shutdown may vary significantly. Depending on the UPS load and number of Extended Battery Modules (EBMs), the "Battery Low" warning may occur before the batteries reaches low capacity.
No Battery  LED is On. Beep continuous.	The batteries are disconnected.	Verify that all batteries are properly connected. If the condition persists, contact your service representative.
Battery fault 	The battery test has failed due to bad or disconnected batteries, or the battery minimum voltage is reached in ABM cycling mode.	Verify that all batteries are properly connected. Start a new battery test: if the condition persists, contact your service representative.

Table 14. Typical Alarm Conditions (Continued)

LED is On. Beep continuous.		
The UPS does not provide the expected backup time.	The batteries need charging or service.	Apply utility power for 48 hours to charge the batteries. If the condition persists, contact your service representative.
Bypass Mode  LED is On.	An overload or a fault has occurred, or a command has been received and the UPS is in Bypass mode	Equipment is powered but not protected by the UPS. Check for one of the following alarms: overtemperature, overload or UPS LED is on failure.
Power Overload  LED is On. 1 beep every 3 seconds.	Power requirements exceed the UPS capacity (greater than 100% of nominal; see in Table 8 on page 8 for specific output overload ranges).	Remove some of the equipment from the UPS. The UPS continues to operate, but may switch to Bypass mode or shut down if the load increases. The alarm resets when the condition becomes inactive.
UPS Overtemperature  LED is On. 1 beep every 3 seconds.	The UPS internal temperature is too high or a fan has failed. At the warning level, the UPS generates the alarm but remains in the current operating state. If the temperature rises another 5°C, the UPS transfers to Bypass mode or shuts down if Bypass is unusable.	If the UPS transferred to Bypass mode, the UPS will return to normal operation when the temperature drops 5°C below the warning level. If the condition persists, shut down the UPS. Clear vents and remove any heat sources. Allow the UPS to cool. Ensure the airflow around the UPS is not restricted. Restart the UPS. If the condition continues to persist, contact your service representative.
The UPS does not start.	A utility failure has occurred. The Remote Power Off (RPO) switch is active or the RPO connector is missing.	Contact a qualified electrician. If the UPS Status menu displays the "Remote Power Off" notice, inactivate the RPO input.

Silencing the Alarm

Press the ESC (Escape) button on the front panel display to mute the alarm. Check the alarm condition and perform the applicable action to resolve the condition. If the alarm status changes, the alarm beeps again, overriding the previous alarm muting.

Question: how do I...	Answer
Turn the UPS on?	<p>Verify that all power modules are securely plugged into the cabinet, and each module secured in it's slot.</p> <p>If external battery cabinets are installed, confirm that the DC emergency disconnect switch button on the back of the cabinet is closed (pulled out). To close the DC emergency disconnect switch button, insert the switch key supplied with the cabinet into the button and turn clockwise 1/2-turn. Pull the button out to close the switch. Turn the key back counter-clockwise, and remove the key.</p> <p>If an external bypass switch is installed, turn the switch to the LINE or UPS position. Refer to the front panel display and press the button labeled ON. (If On/Off control is password-protected, enter your password. Confirm the selection by pressing the button labeled Yes. After a few seconds, the green LED illuminates to signal the UPS is operating and producing power.</p>
Turn the UPS off?	<p>Refer to the front panel display and press the button labeled OFF. Confirm the selection by pressing the button labeled Yes. (If On/Off control is password-protected, enter your password.</p>
Turn off the alarm beeps?	<p>Press the lower left button on the front panel display. Note the alarm message and see "Typical Alarms and Faults" on page 107 to correct the problem. After the problem has been resolved, press the lower center button to clear the alarm.</p>
View the alarm log?	<p>Go to the menus in Figure 70 . Press the enter button to view the most recent alarm. Press the down arrow button to scroll down through the log to view previous alarms.</p>
Check the input or output voltage?	<p>Go to the menus in Figure 61 to select the input and output voltages.</p>
Check the battery voltage?	<p>Go to menu in Figure 61 To view other system status parameters</p>
Check the condition of the batteries?	<p>The results of the most recent battery test are stored in the battery menu. To run a test of the battery condition, go to the menu in Figure 62 and press the enter button. When the test is complete, the results are again stored in the battery results parameter.</p>
Apply power to the load if the unit will not operate?	<p>Turn the optional external bypass switch to either the SERVICE or the LINE position. In these two positions, utility power flows directly to the load. In the SERVICE position, the UPS does not receive utility power and may be worked on for maintenance purposes.</p>
Turn the external bypass	<p>You must press the red button beside the switch before turning the switch.</p>
Set the UPS to turn on in High Efficiency mode?	<p>From the In\Out settings menu select High Efficiency mode then select Enabled (see Figure 64)</p>
Change the level of system redundancy?	<p>To view or change the redundancy level, go to the menu in Figure 64.</p>

Question: how do I...	Answer
Change the batteries?	Each pair of battery modules of a two-battery slot forms one series slot on the battery bus. See “ 9.4 Battery Replacement ” for the battery replacement procedure.
Add/delete one or more slots of batteries?	Physically install or remove battery modules as described in “ 9.4 Battery Replacement ”. If not using a 9PXM EBM, record the capacity of external battery slots (in all external battery cabinets) by going to menu Figure 61 .
Add/delete one or more power modules?	Physically install or remove power modules as described in “ 9.5 Power Module Replacement ”. The system operating software senses the number and location of all power modules in the cabinet. If you want to change the number of redundant power modules, go to menu in Figure 64 and change the level of system redundancy.

11.2 Service and Support

If you have any questions or problems with the UPS, call your **Local Distributor** or the **Help Desk** at one of the following telephone numbers and ask for a UPS technical representative.

United States:	1-800-356-5737
Canada:	1-800-461-9166 ext 260
All other countries:	Call your local service representative

Please have the following information ready when you call the Help Desk:

- Model number
- Serial number
- Version number (if available)
- Date of failure or problem
- Symptoms of failure or problem
- Customer return address and contact information

If repair is required, you will be given a Returned Material Authorization (RMA) Number. This number must appear on the outside of the package and on the Bill Of Lading (if applicable). Use the original packaging or request packaging from the Help Desk or distributor. Units damaged in shipment as a result of improper packaging are not covered under warranty. A replacement or repair unit will be shipped, freight prepaid for all warrantied units.



NOTE

For critical applications, immediate replacement may be available. Call the Help **Desk** for the dealer or distributor nearest you.

11.3 Two-Year Limited Warranty

[Eaton 9PXM Two-Year Limited Warranty](#)

[Eaton 9PXM UPS Load Protection Guarantee](#)



P-164000669 10