



HP Desktop Mini Hardware Reference Guide

© Copyright 2018 HP Development Company, L.P.

Windows is either a registered trademark or trademark of Microsoft Corporation in the United States and/or other countries.

The information contained herein is subject to change without notice. The only warranties for HP products and services are set forth in the express warranty statements accompanying such products and services. Nothing herein should be construed as constituting an additional warranty. HP shall not be liable for technical or editorial errors or omissions contained herein.

Second Edition: April 2018

First Edition: March 2018

Document Part Number: L21501-002

Product Notice

This guide describes features that are common to most products. Some features may not be available on your computer.

Not all features are available in all editions or versions of Windows. Systems may require upgraded and/or separately purchased hardware, drivers, software or BIOS update to take full advantage of Windows functionality. Windows 10 is automatically updated, which is always enabled. ISP fees may apply and additional requirements may apply over time for updates. Go to <http://www.microsoft.com> for details.

To access the latest user guides, go to <http://www.hp.com/support>, and follow the instructions to find your product. Then select **User Guides**.

Software terms

By installing, copying, downloading, or otherwise using any software product preinstalled on this computer, you agree to be bound by the terms of the HP End User License Agreement (EULA). If you do not accept these license terms, your sole remedy is to return the entire unused product (hardware and software) within 14 days for a refund subject to the refund policy of your seller.

For any further information or to request a full refund of the price of the computer, please contact your seller.

About This Book

This guide provides basic information for upgrading the HP Desktop Mini Business PC.





-
-  **WARNING!** Indicates a hazardous situation that, if not avoided, **could** result in death or serious injury.
 -  **CAUTION:** Indicates a hazardous situation that, if not avoided, **could** result in minor or moderate injury.
 -  **IMPORTANT:** Indicates information considered important but not hazard-related (for example, messages related to property damage). A notice alerts the user that failure to follow a procedure exactly as described could result in loss of data or in damage to hardware or software. Also contains essential information to explain a concept or to complete a task.
 -  **NOTE:** Contains additional information to emphasize or supplement important points of the main text.
 -  **TIP:** Provides helpful hints for completing a task
-

Table of contents

1 Product features	1
Standard configuration features	1
Front panel components (HP EliteDesk 800 and HP ProDesk 600)	2
Front panel components (HP ProDesk 400)	3
Rear panel components	4
Serial number location	5
2 Setup	6
Changing from desktop to tower orientation	6
Attaching the computer to a mounting fixture	7
Installing a security cable	8
Connecting the power cord	8
3 Hardware upgrades	9
Serviceability features	9
Warnings and cautions	9
Removing and installing the access panel	10
Removing the access panel	10
Installing the access panel	11
Removing and installing the access panel of the HP EliteDesk 800 35W	11
Removing the access panel of the HP EliteDesk 800 35W	11
Installing the access panel of the HP EliteDesk 800 35W	13
Upgrading system memory	14
Memory module specifications	14
Populating memory module slots	15
Installing a memory module	16
Removing a hard drive	19
Installing a hard drive	20
Replacing an M.2 PCIe solid-state drive	21
Replacing the WLAN module	24
Installing an external antenna	27

Replacing the battery	30
Synchronizing the optional wireless keyboard and mouse	34
Appendix A Electrostatic discharge	36
Preventing electrostatic damage	36
Grounding methods	36
Appendix B Computer operating guidelines, routine care and shipping preparation	37
Computer operating guidelines and routine care	37
Shipping preparation	38
Appendix C Accessibility	39
Supported assistive technologies	39
Contacting support	39
Index	40

1 Product features

Standard configuration features

Features may vary depending on the model. For a complete listing of the hardware and software installed in the computer, run the diagnostic utility (included on some computer models only).







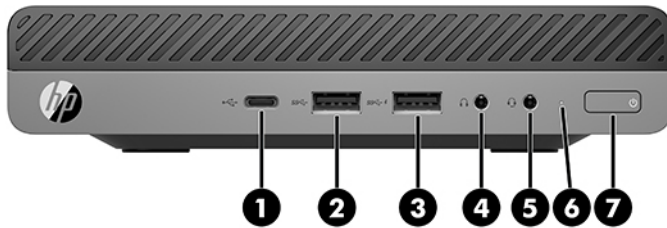

NOTE: This computer model can be used in a tower orientation or a desktop orientation. The tower stand is sold separately.

Front panel components (HP EliteDesk 800 and HP ProDesk 600)



 **NOTE:** Your computer model may look slightly different from the illustration in this section.

Item	Icon	Component	Item	Icon	Component
1		USB Type-C SuperSpeed port with HP Sleep and Charge*	5		Audio-out (headphone)/Audio-in (microphone) combo jack
2		USB SuperSpeed port	6		Main storage LED
3		USB SuperSpeed port with HP Sleep and Charge*	7		Dual-state power button
4		Headphone jack			



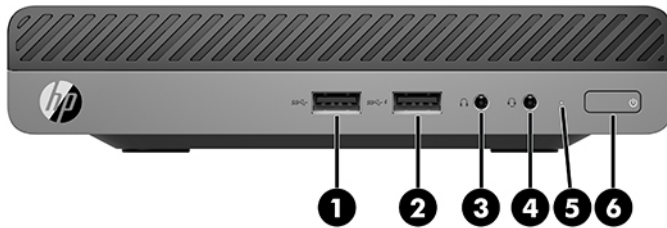

*When the computer is on, the USB port connects a USB device, provides high-speed data transfer, and even when the computer is off, charges products such as a cell phone, camera, activity tracker, or smartwatch.

NOTE: The main storage LED is normally white when the power is on. If it is flashing red, there is a problem with the computer and the main storage LED is displaying a diagnostic code. Refer to the *Maintenance and Service Guide* to interpret the code.

Front panel components (HP ProDesk 400)



 **NOTE:** Your computer model may look slightly different from the illustration in this section.

Item	Icon	Component	Item	Icon	Component
1		USB Type-C SuperSpeed port	4		Audio-out (headphone)/Audio-in (microphone) combo jack
2		USB Type-C SuperSpeed port with HP Sleep and Charge*	5		Main storage LED
3		Headphone jack	6		Dual-state power button





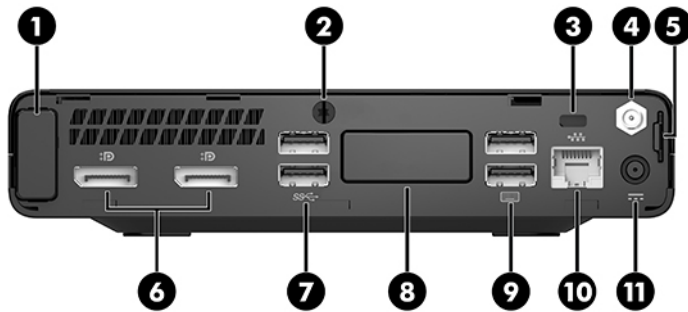

*When the computer is on, the USB port connects a USB device, provides high-speed data transfer, and even when the computer is off, charges products such as a cellphone, camera, activity tracker, or smartwatch.

NOTE: The main storage LED is normally white when the power is on. If it is flashing red, there is a problem with the computer and the main storage LED is displaying a diagnostic code. Refer to the *Maintenance and Service Guide* to interpret the code.

Rear panel components



NOTE: Your computer model may look slightly different from the illustration in this section.

Item	Icon	Component	Item	Icon	Component
1		Antenna cover	7		USB SuperSpeed port
2		Thumbscrew	8		Optional port One of the following ports may be used: DisplayPort, HDMI, VGA, USB Type-C, serial port, Thunderbolt, or Fiber NIC.
3		Security cable slot	9		USB ports (2) (black)
4		External antenna connector (optional)	10		RJ-45 (network) jack/status lights
5		Padlock loop	11		Power connector
6		Dual-Mode DisplayPort (2)			

Serial number location

Each computer has a unique serial number and a product ID number that are located on the exterior of the computer. Keep these numbers available for use when contacting support for assistance.

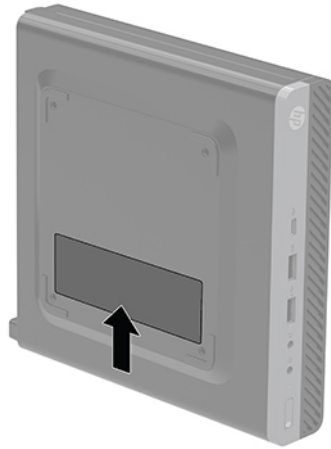

2 Setup

Changing from desktop to tower orientation

 **IMPORTANT:** Be sure that at least 10.2 centimeters (4 inches) of space on all sides of the computer remains clear and free of obstructions.

The computer can be used in a tower orientation with an optional tower stand that can be purchased from HP.

 **NOTE:** To stabilize the computer in a tower orientation, HP recommends the use of the optional tower stand.

1. Remove/disengage any security devices that prohibit opening the computer.
2. Remove all removable media, such as a USB flash drive, from the computer.
3. Turn off the computer properly through the operating system, then turn off any external devices.
4. Disconnect the power cord from the AC outlet and disconnect any external devices.

 **CAUTION:** Regardless of the power-on state, voltage is always present on the system board as long as the system is plugged into an active AC outlet. To avoid damage to the internal components of the computer, you must disconnect the power cord.

5. Orient the computer so that its right side is facing up, and place the computer in the optional stand.

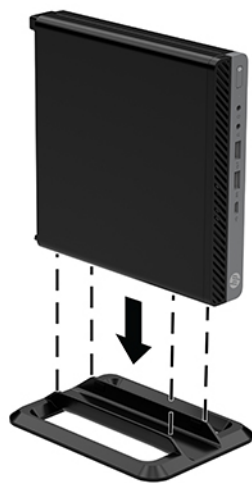

6. Reconnect the power cord and any external devices, then turn on the computer.

 **IMPORTANT:** Be sure that at least 10.2 centimeters (4 inches) of space on all sides of the computer remains clear and free of obstructions.

7. Lock any security devices that were disengaged when the access panel was removed.

Attaching the computer to a mounting fixture

The computer can be attached to a wall, swing arm, or other mounting fixture.

 **NOTE:** This apparatus is intended to be supported by UL or CSA Listed wall-mount bracket.

1. If the computer is on a stand, remove the computer from the stand and position the computer right-side up on a stable surface.
2. To attach the computer to a swing arm (sold separately), insert four screws through the holes on the swing arm plate and into the mounting holes on the computer.

 **CAUTION:** This computer supports the VESA industry standard 100 mm mounting holes. To attach a third-party mounting solution to the computer, use the screws that are supplied with the solution. It is important to verify that the manufacturer's mounting solution is compliant with the VESA standard and is rated to support the weight of the computer. For best performance, it is important to use the power cord and other cables provided with the computer.

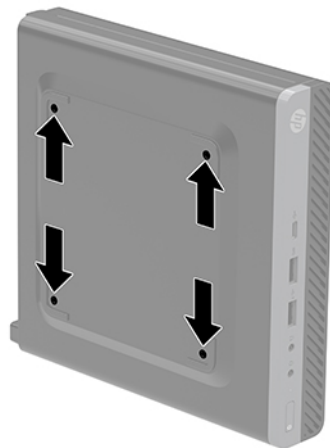

To attach the computer to other mounting fixtures, follow the instructions included with the mounting fixture to ensure that the computer is safely attached.

Installing a security cable

The security cable displayed below can be used to secure the computer.

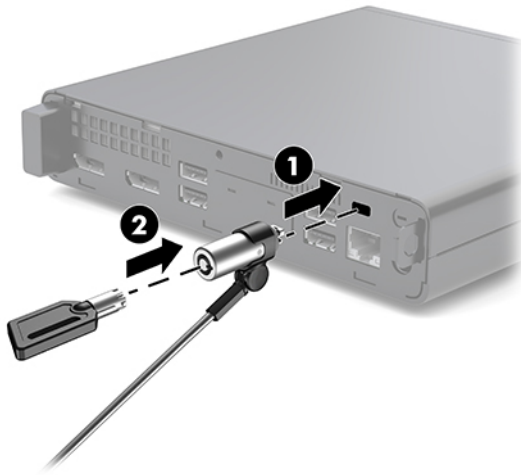

NOTE: The security cable is designed to act as a deterrent, but it may not prevent the computer from being mishandled or stolen.

Connecting the power cord

When connecting the AC adapter, it is important to follow the steps below to ensure that the power cord does not pull free from the computer.

1. Connect the power cord to the AC adapter (1).
2. Plug the power cord into an AC outlet (2).
3. Connect the AC adapter to the power connector on the rear of the computer (3).

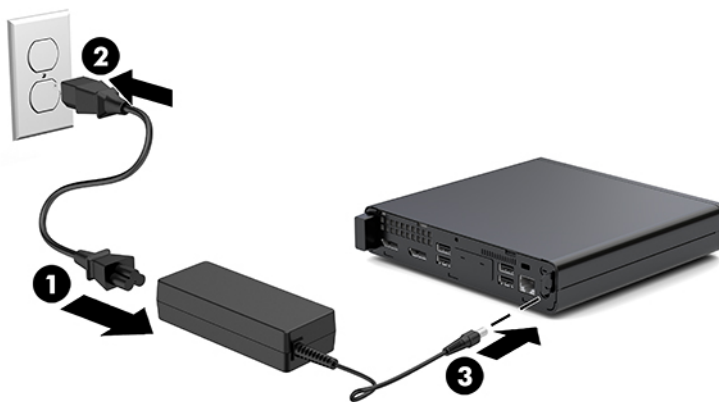

3 Hardware upgrades

Serviceability features

The computer includes features that make it easy to upgrade and service. No tools are needed for most of the installation procedures described in this chapter.

Warnings and cautions

Before performing upgrades be sure to carefully read all of the applicable instructions, cautions, and warnings in this guide.

 **WARNING!** To reduce the risk of personal injury from electrical shock, hot surfaces, or fire:

Disconnect the power cord from the AC outlet and allow the internal system components to cool before touching.

Do not connect telecommunications or telephone connectors to the network interface controller (NIC) receptacles.

Do not disable the power cord grounding plug. The grounding plug is an important safety feature.

Plug the power cord in a grounded (earthed) AC outlet that is easily accessible at all times.

To reduce the risk of serious injury, read the *Safety & Comfort Guide*. It describes proper workstation, setup, posture, and health and work habits for computer users, and provides important electrical and mechanical safety information. This guide is located on the web at <http://www.hp.com/ergo>.

 **WARNING!** Energized and moving parts inside.

Disconnect power to the equipment before removing the enclosure.

Replace and secure the enclosure before re-energizing the equipment.

 **CAUTION:** Static electricity can damage the electrical components of the computer or optional equipment. Before beginning these procedures, ensure that you are discharged of static electricity by briefly touching a grounded metal object. See [Electrostatic discharge on page 36](#) for more information.

When the computer is plugged into an AC power source, voltage is always applied to the system board. You must disconnect the power cord from the power source before opening the computer to prevent damage to internal components.

 **NOTE:** Your computer model may look slightly different from the illustrations in this chapter.

Removing and installing the access panel

 **NOTE:** For the HP EliteDesk 800 35W, see [Removing and installing the access panel of the HP EliteDesk 800 35W on page 11](#).

Removing the access panel

To access internal components, you must remove the access panel:

 **WARNING!** To reduce risk of personal injury from hot surfaces, allow the internal system components to cool before you touch them.

1. Remove/disengage any security devices that prohibit opening the computer.
2. Remove all removable media, such as a USB flash drive, from the computer.
3. Turn off the computer properly through the operating system, then turn off any external devices.
4. Disconnect the power cord from the AC outlet and disconnect any external devices.

 **CAUTION:** Regardless of the power-on state, voltage is always present on the system board as long as the system is plugged into an active AC outlet. You must disconnect the power cord to avoid damage to the internal components of the computer.

5. If the computer is on a stand, remove the computer from the stand. Then position the computer right-side up on a stable surface.
6. Loosen the thumbscrew (1) on the rear panel as shown in the following image.

 **NOTE:** If necessary, a Torx T-15 screwdriver may be used to loosen the thumbscrew.

7. Slide the access panel forward, and lift it off the computer (2).

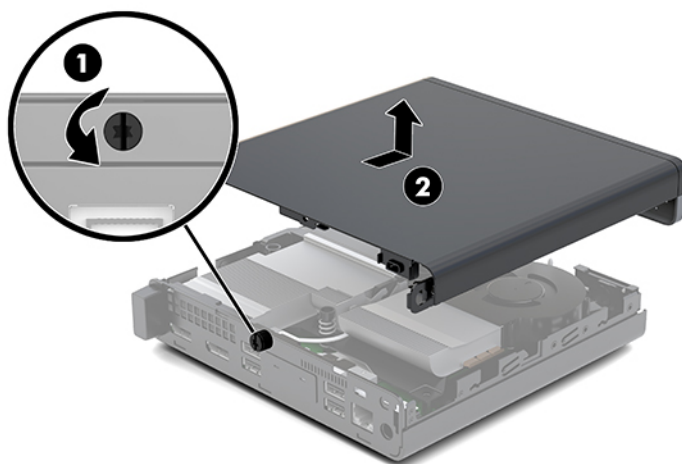

 **WARNING!** To reduce risk of personal injury from hot surfaces, allow the internal system components to cool before you touch them.

 **NOTE:** Your computer model may look slightly different from the illustrations in this section.

Installing the access panel

1. Place the access panel on the computer and slide it back (1).
2. When the access panel slides into place, tighten the thumbscrew (2) to secure the access panel in place as shown in the following image.

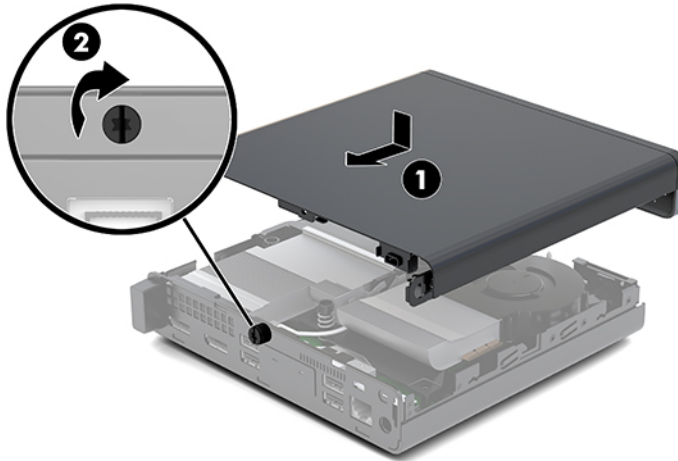

 **NOTE:** Your computer model may look slightly different from the illustration in this section.

Removing and installing the access panel of the HP EliteDesk 800 35W

 **NOTE:** For models other than the HP EliteDesk 800 35W, see [Removing and installing the access panel on page 10](#).

Removing the access panel of the HP EliteDesk 800 35W

To access internal components, you must remove the access panel and the discrete graphics processing unit (DGPU):

1. Remove/disengage any security devices that prohibit opening the computer.
2. Remove all removable media, such as a USB flash drive, from the computer.
3. Turn off the computer properly through the operating system, then turn off any external devices.
4. Disconnect the power cord from the AC outlet and disconnect any external devices.

 **CAUTION:** Regardless of the power-on state, voltage is always present on the system board as long as the system is plugged into an active AC outlet. You must disconnect the power cord to avoid damage to the internal components of the computer.

5. If the computer is on a stand, remove the computer from the stand. Then position the computer right-side up on a stable surface.
6. Loosen the thumbscrew (1) on the rear panel as shown in the following image.

 **NOTE:** If necessary, a Torx T-15 screwdriver may be used to loosen the thumbscrew.

7. Slide the access panel forward, and lift it off the computer (2).

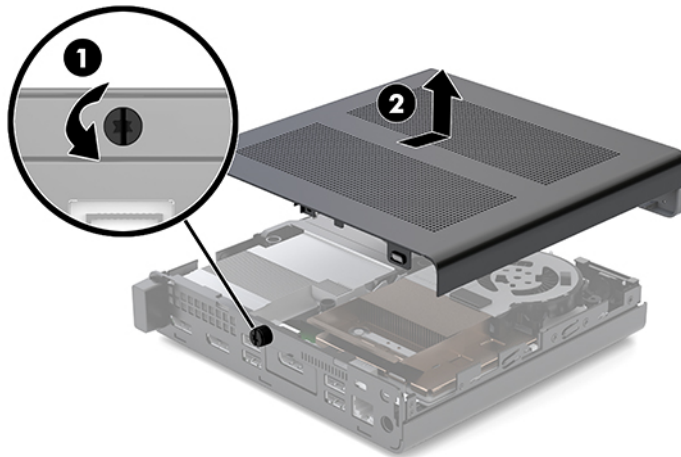

⚠ WARNING! To reduce risk of personal injury from hot surfaces, allow the internal system components to cool before you touch them.

📝 NOTE: Your computer model may look slightly different from the illustrations in this section.

8. Disconnect the fan cable (1) from the system board.
9. Remove the three screws (2) securing the DGPU to the system board.

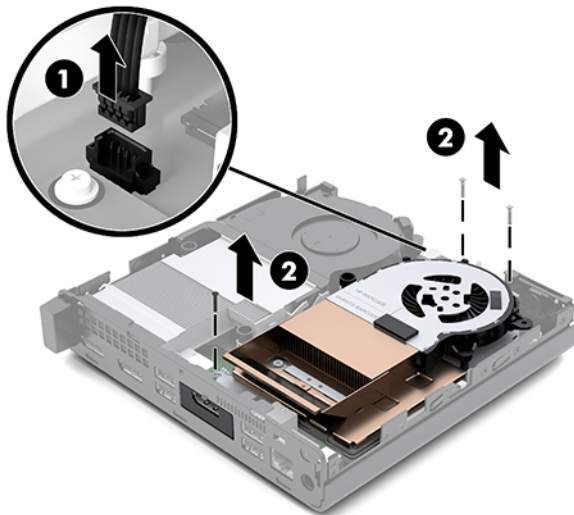

10. Lift the DGPU up by the tab at the fan end and pull the DGPU up out of the chassis.

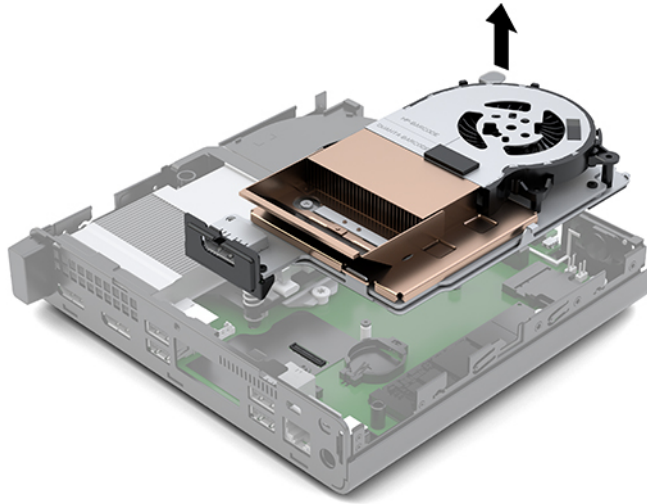

Installing the access panel of the HP EliteDesk 800 35W

This procedure includes installing the DGPU and the access panel.

1. Set the DGPU into the chassis and secure it to the system board with three screws: two screws at the fan end of the DGPU and one screw at the inner corner of the opposite end of the DGPU (1).
2. Plug the fan cable into the connector (2) on the system board.

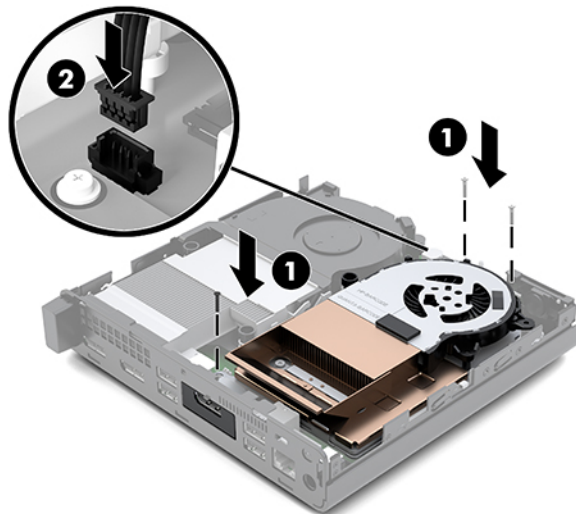

3. Place the access panel on the computer and slide it back (1).

4. When the access panel slides into place, tighten the thumbscrew (2) to secure the access panel in place as shown in the following image.

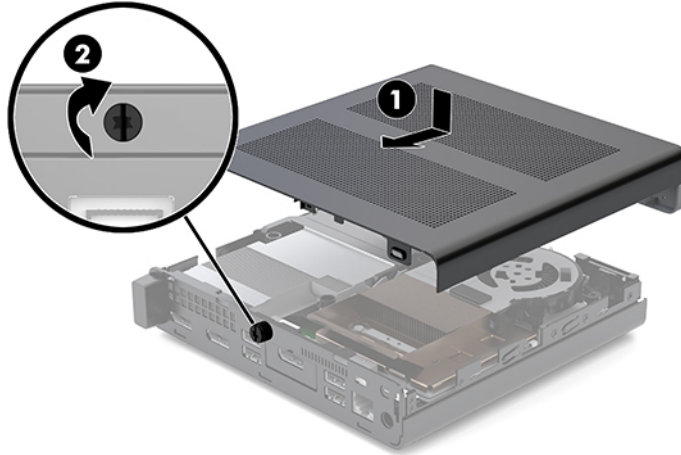

 **NOTE:** Your computer model may look slightly different from the illustration in this section.

Upgrading system memory

The computer comes with at least one small outline, dual in-line memory module (SODIMM). To achieve maximum memory support, you can populate the system board with up to 32 GB of memory.

Memory module specifications

For proper system operation, the memory modules must adhere to the following specifications.

Component	Specification
Memory modules	1.2 volt DDR4-SDRAM memory modules
Compliance	Unbuffered non-ECC PC4-17000 DDR4-2133 MHz-compliant
Pins	Industry-standard 260-pin containing the mandatory Joint Electronic Device Engineering Council (JEDEC) specification
Support	CAS latency 15 DDR4 2400 MHz (15-15-15 timing)
Slots	2
Maximum Memory	32 GB
Supported	2 Gbit, 4 Gbit, 8 Gbit, and 16 Gbit non-ECC memory technologies single-sided and double-sided memory modules

NOTE: The system does not operate properly if you install unsupported memory modules. Memory modules constructed with x8 and x16 DDR devices are supported; memory modules constructed with x4 SDRAM are not supported.

HP offers upgrade memory for this computer and advises that the consumer purchase it to avoid compatibility issues with unsupported third-party memory.

Populating memory module slots

There are two memory module slots on the system board, with one slot per channel. The sockets are labeled DIMM1 and DIMM3. The DIMM1 slot operates in memory channel B. The DIMM3 slot operates in memory channel A.

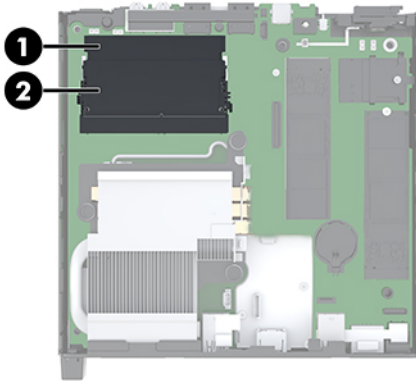

Item	Description	System Board Label	Slot Color
1	Memory module slot, Channel B	DIMM1	Black
2	Memory module slot, Channel A	DIMM3	Black

The system will automatically operate in single-channel mode, dual-channel mode, or flex mode, depending on how the memory modules are installed.

- The system will operate in single-channel mode if the memory module slots are populated in one channel only.
- The system will operate in a higher-performing dual-channel mode if the memory capacity of the memory module in Channel A is equal to the memory capacity of the memory module in Channel B.
- The system will operate in flex mode if the memory capacity of the memory module in Channel A is not equal to the memory capacity of the memory module in Channel B. In flex mode, the channel populated with the least amount of memory describes the total amount of memory assigned to dual-channel and the remainder is assigned to single-channel. If one channel will have more memory than the other, the larger amount should be assigned to channel A.
- In any mode, the maximum operational speed is determined by the slowest memory module in the system.

Installing a memory module

⚠ CAUTION: You must disconnect the power cord and wait approximately 30 seconds for the power to drain before adding or removing memory modules. Regardless of the power-on state, voltage is always supplied to the memory modules as long as the computer is plugged into an active AC outlet. Adding or removing memory modules while voltage is present may cause irreparable damage to the memory modules or system board.

The memory module slots have gold-plated metal contacts. When upgrading the memory, it is important to use memory modules with gold-plated metal contacts to prevent corrosion and/or oxidation resulting from having incompatible metals in contact with each other.

Static electricity can damage the electronic components of the computer or optional cards. Before beginning these procedures, ensure that you are discharged of static electricity by briefly touching a grounded metal object. For more information, see [Electrostatic discharge on page 36](#).

When handling a memory module, be careful not to touch any of the contacts. Doing so may damage the module.

1. Remove/disengage any security devices that prohibit opening the computer.
2. Remove all removable media, such as a USB flash drive, from the computer.
3. Turn off the computer properly through the operating system, and then turn off any external devices.
4. Disconnect the power cord from the AC outlet and disconnect any external devices.
5. Remove the access panel.
 - For instructions on removing the access panel from a 35W model, see [Removing the access panel of the HP EliteDesk 800 35W on page 11](#).
 - For instructions on removing the access panel from any other model, see [Removing the access panel on page 10](#).

For instructions, see [Removing the access panel on page 10](#).

⚠ WARNING! To reduce risk of personal injury from hot surfaces, allow the internal system components to cool before you touch them.

6. Tilt the fan up using the front tab and leave it in the up position.

 **NOTE:** It is not necessary to fully remove the fan to remove or install a memory module.

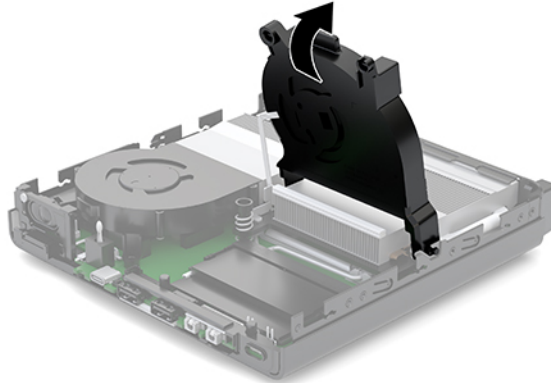

7. Locate the memory modules on the system board.

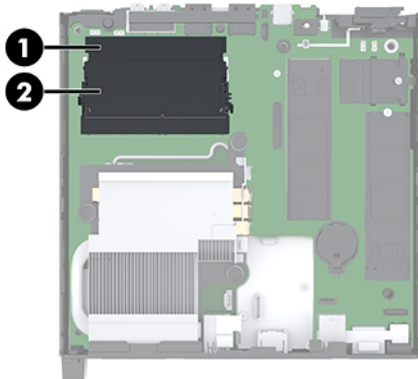

8. To remove a memory module, press outward on the latches (1) on each side of the memory module, and then pull the memory module (2) out of the slot.



- Slide the new memory module (1) into the slot at approximately a 30° angle, and press the memory module down (2) so that the latches lock it in place.



 **NOTE:** A memory module can be installed in only one way. Match the notch on the module with the tab on the memory module slot.

- Tilt the fan down, and then press the fan down until it clicks into place.

 **CAUTION:** Avoid pulling the fan cable.

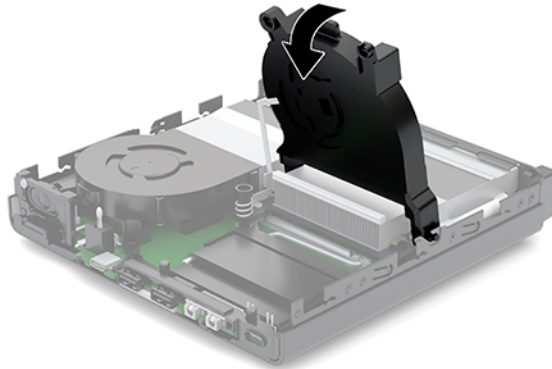

- Install the access panel.

- For instructions on installing the access panel on a 35W model, see [Installing the access panel of the HP EliteDesk 800 35W on page 13](#).
- For instructions on installing the access panel on any other model, see [Installing the access panel on page 11](#).

- If the computer was on a stand, replace the stand.

- Reconnect external devices, plug in the power cord, and then turn on the computer. The computer automatically recognizes the new memory.

- Lock any security devices that were disengaged when the access panel was removed.

Removing a hard drive

 **NOTE:** Before you remove the old hard drive, be sure to back up the data from the old hard drive so that you can transfer the data to the new hard drive.

1. Remove/disengage any security devices that prohibit opening the computer.
2. Remove all removable media, such as a USB flash drive, from the computer.
3. Turn off the computer properly through the operating system, then turn off any external devices.
4. Disconnect the power cord from the AC outlet and disconnect any external devices.

 **CAUTION:** Regardless of the power-on state, voltage is always present on the system board as long as the system is plugged into an active AC outlet. You must disconnect the power cord to avoid damage to the internal components of the computer.

5. Remove the access panel.
 - For instructions on removing the access panel from a 35W model, see [Removing the access panel of the HP EliteDesk 800 35W on page 11](#).
 - For instructions on removing the access panel from any other model, see [Removing the access panel on page 10](#).

For instructions, see [Removing the access panel on page 10](#).

 **WARNING!** To reduce risk of personal injury from hot surfaces, allow the internal system components to cool before you touch them.

6. To remove the hard drive, rotate the hard drive latch up and out (1) to disengage the hard drive from the cage.
7. Slide the drive toward the rear of the chassis until it stops, and then lift the hard drive up and out of the cage (2).

 **NOTE:** The power cable from the system board is located in the drive cage and disconnects when the hard drive is removed.

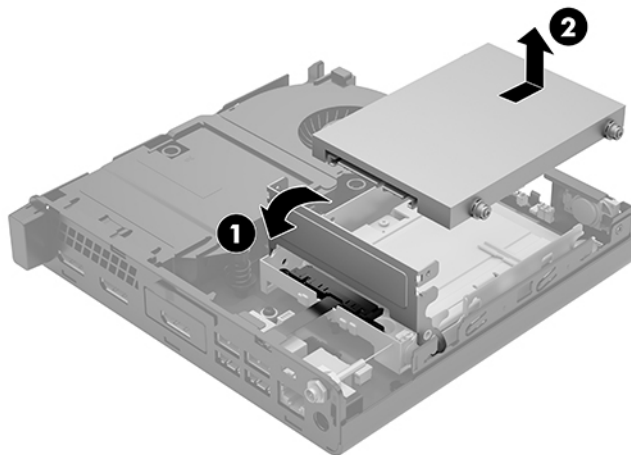

Installing a hard drive

 **NOTE:** Before you remove the old hard drive, be sure to back up the data from the old hard drive so that you can transfer the data to the new hard drive.

1. If you are replacing a hard drive, transfer the silver and blue isolation mounting guide screws from the old hard drive to the new hard drive.

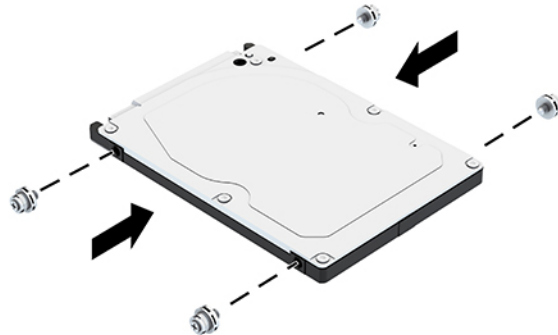

2. Align the hard drive guide screws with the slots on the hard drive cage, press the hard drive down into the cage, and then slide it forward until it stops and locks into place (1).
3. Rotate the hard drive latch down (2) to engage the hard drive.

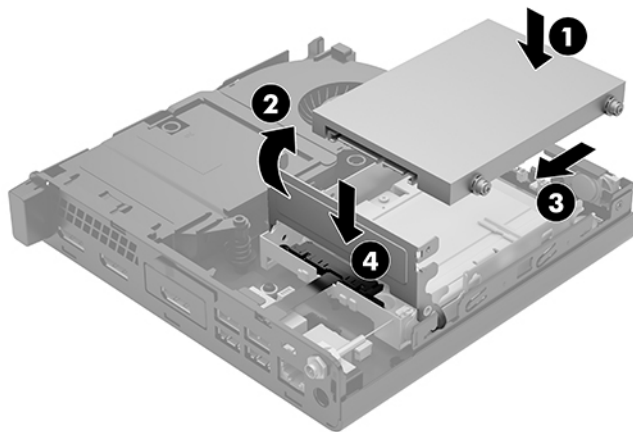

4. Install the access panel.
 - For instructions on installing the access panel on a 35W model, see [Installing the access panel of the HP EliteDesk 800 35W on page 13](#).
 - For instructions on installing the access panel on any other model, see [Installing the access panel on page 11](#).

5. If the computer was on a stand, replace the stand.
6. Reconnect external devices, plug in the power cord, and then turn on the computer.
7. Lock any security devices that were disengaged when the access panel was removed.

Replacing an M.2 PCIe solid-state drive

1. Remove/disengage any security devices that prohibit opening the computer.
2. Remove all removable media, such as a USB flash drive, from the computer.
3. Turn off the computer properly through the operating system, then turn off any external devices.
4. Disconnect the power cord from the AC outlet and disconnect any external devices.

⚠ CAUTION: Regardless of the power-on state, voltage is always present on the system board as long as the system is plugged into an active AC outlet. You must disconnect the power cord to avoid damage to the internal components of the computer.

5. Remove the access panel.

- For instructions on removing the access panel from a 35W model, see [Removing the access panel of the HP EliteDesk 800 35W on page 11](#).
- For instructions on removing the access panel from any other model, see [Removing the access panel on page 10](#).

⚠ WARNING! To reduce risk of personal injury from hot surfaces, allow the internal system components to cool before you touch them.

6. If your model is an EliteDesk 800 95W, remove the fan assembly.
 - a. Disconnect the fan assembly plug (1) from the system board.
 - b. Loosen the three captive screws securing the fan assembly (2).
 - c. Lift the fan assembly out of the chassis (3).

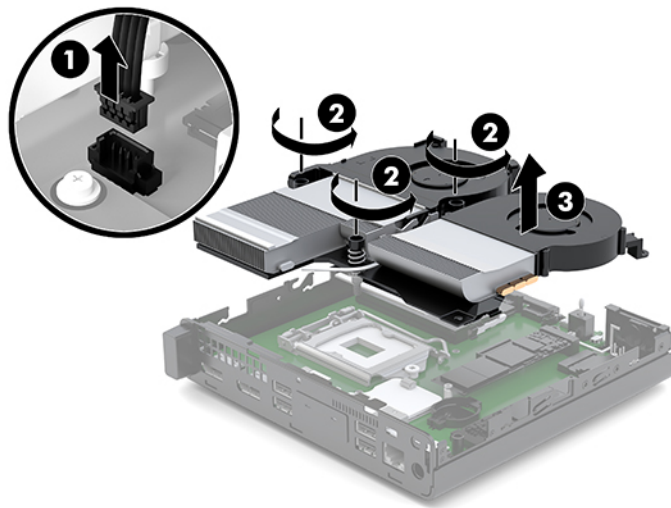

7. Locate the solid-state drives on the system board.

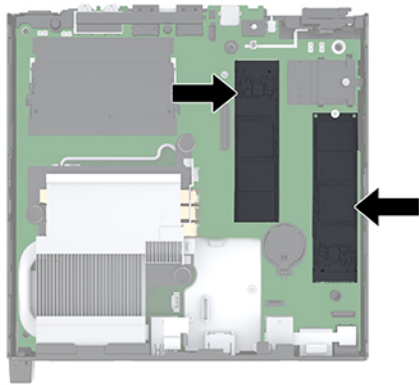

8. Remove the screw securing a solid-state drive to the system board (1).
9. Grasp the solid-state drive by the sides and carefully pull it out of the socket (2).
10. Remove the screw holder from the solid-state drive (3) for use on the replacement solid-state drive.

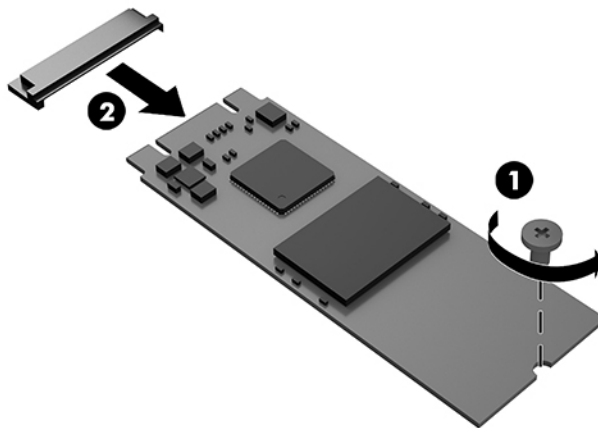

11. Insert the screw holder into the niche on the end of the new solid-state drive (1).
12. Insert the new solid-state drive into the socket on the system board and press the solid-state drive connectors (2) firmly into the socket.

 **NOTE:** A solid-state drive can be installed in only one way.

- 13.** Press the solid-state drive down to the system board and use the included screw (3) to secure the solid-state drive.

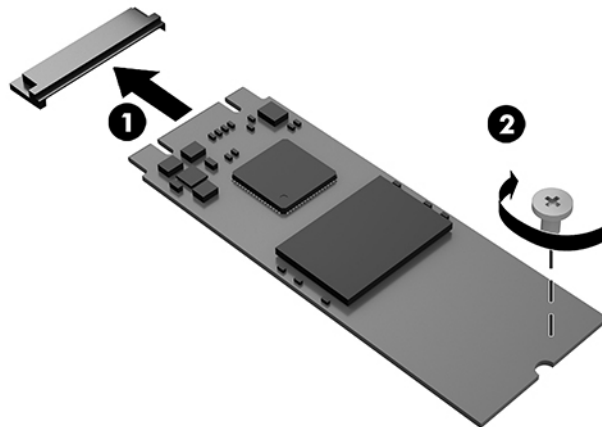

- 14.** If your model is an EliteDesk 800 95W, replace the fan assembly.
- Set the fan assembly in place (1).
 - Tighten the three captive screws to secure the fan assembly to the chassis (2).
 - Connect the fan assembly plug to the system board (3).

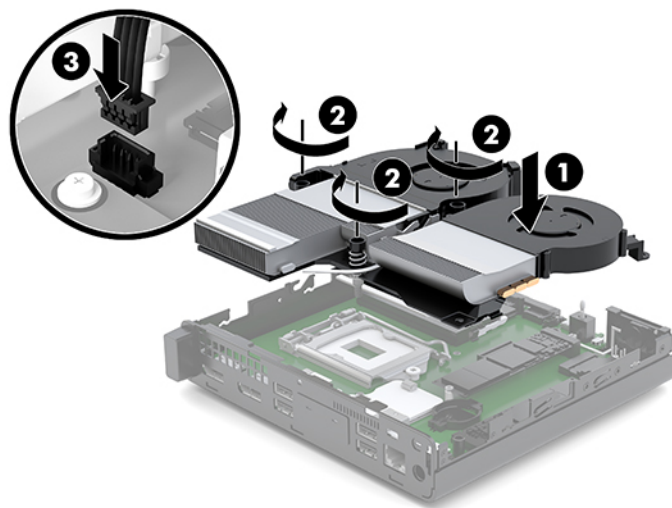

- 15.** Install the access panel.
- For instructions on installing the access panel on a 35W model, see [Installing the access panel of the HP EliteDesk 800 35W on page 13](#).
 - For instructions on installing the access panel on any other model, see [Installing the access panel on page 11](#).
- 16.** If the computer was on a stand, replace the stand.

17. Reconnect external devices, plug in the power cord, and then turn on the computer.
18. Lock any security devices that were disengaged when the access panel was removed.

Replacing the WLAN module

1. Remove/disengage any security devices that prohibit opening the computer.
2. Remove all removable media, such as a USB flash drive, from the computer.
3. Turn off the computer properly through the operating system, then turn off any external devices.
4. Disconnect the power cord from the AC outlet and disconnect any external devices.

CAUTION: Regardless of the power-on state, voltage is always present on the system board as long as the system is plugged into an active AC outlet. You must disconnect the power cord to avoid damage to the internal components of the computer.

5. Remove the access panel.
 - For instructions on removing the access panel from a 35W model, see [Removing the access panel of the HP EliteDesk 800 35W on page 11](#).
 - For instructions on removing the access panel from any other model, see [Removing the access panel on page 10](#).

WARNING! To reduce risk of personal injury from hot surfaces, allow the internal system components to cool before you touch them.

6. If your model is an EliteDesk 800 95W, remove the fan assembly.
 - a. Disconnect the fan assembly plug (1) from the system board.
 - b. Loosen the three captive screws securing the fan assembly (2).
 - c. Lift the fan assembly out of the chassis (3).

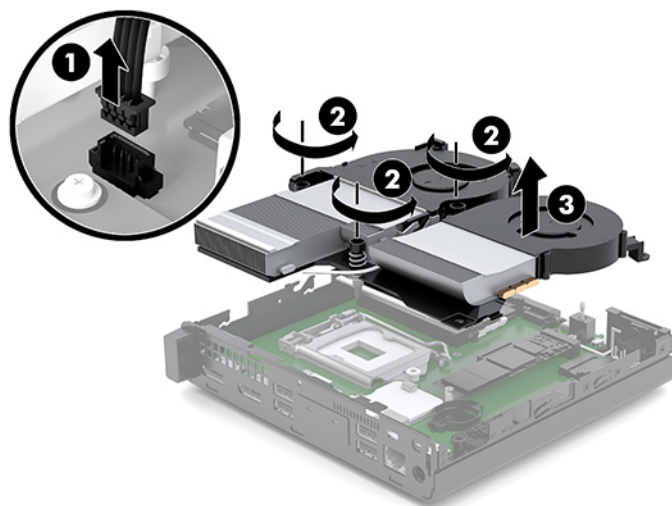

7. Locate the WLAN module on the system board.

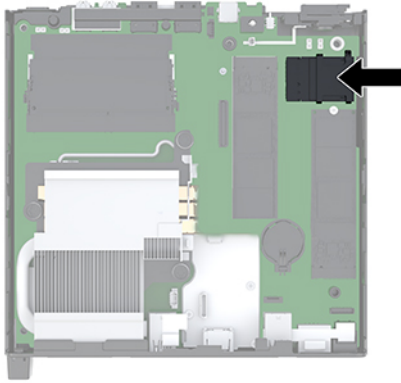

8. Disconnect both antenna cables (1) from the WLAN module.

 **NOTE:** You may need to use a small tool, such as a pair of tweezers or needle-nose pliers, to disconnect and connect the antenna cables.

9. Remove the screw (2) securing the WLAN module to the system board.
10. Grasp the WLAN module (3) by the sides and pull it out of the socket.

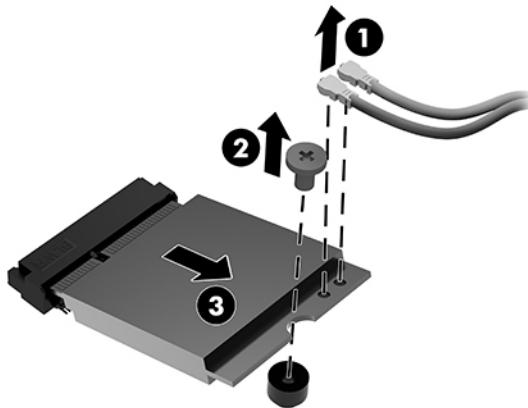

11. Insert the new WLAN module into the socket on the system board. Press the WLAN module connectors firmly into the socket (1).

 **NOTE:** A WLAN module can be installed in only one way.

12. Press the WLAN module down to the system board and use the included screw to secure the module (2).

13. Match the label on each antenna cable to the corresponding connector on the WLAN module and attach the antennas (3) to the connectors.

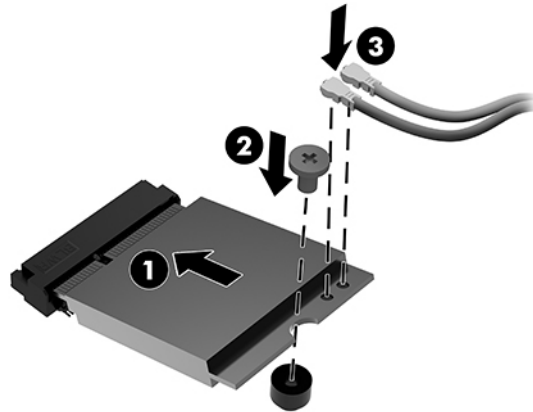

14. If your model is an EliteDesk 800 95W, replace the fan assembly.
- Set the fan assembly in place (1).
 - Tighten the three captive screws to secure the fan assembly to the chassis (2).
 - Connect the fan assembly plug to the system board (3).

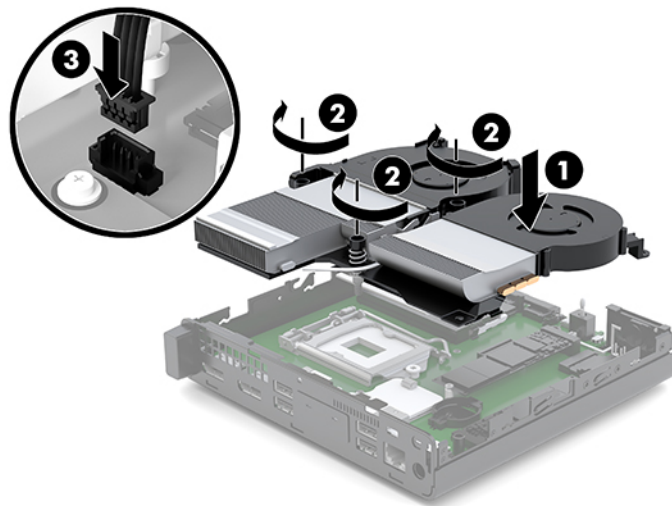

15. Install the access panel.
- For instructions on installing the access panel on a 35W model, see [Installing the access panel of the HP EliteDesk 800 35W on page 13](#).
 - For instructions on installing the access panel on any other model, see [Installing the access panel on page 11](#).
16. If the computer was on a stand, replace the stand.

17. Reconnect external devices, plug in the power cord, and then turn on the computer.
18. Lock any security devices that were disengaged when the access panel was removed.

Installing an external antenna

Internal WLAN antennas are standard. If the computer is to be installed in a metal kiosk or other enclosure, you may wish or need to use an external WLAN antenna.

1. Remove/disengage any security devices that prohibit opening the computer.
2. Remove all removable media, such as a USB flash drive, from the computer.
3. Turn off the computer properly through the operating system, then turn off any external devices.
4. Disconnect the power cord from the AC outlet and disconnect any external devices.

⚠ CAUTION: Regardless of the power-on state, voltage is always present on the system board as long as the system is plugged into an active AC outlet. You must disconnect the power cord to avoid damage to the internal components of the computer.

5. Remove the access panel.

- For instructions on removing the access panel from a 35W model, see [Removing the access panel of the HP EliteDesk 800 35W on page 11](#).
- For instructions on removing the access panel from any other model, see [Removing the access panel on page 10](#).

⚠ WARNING! To reduce risk of personal injury from hot surfaces, allow the internal system components to cool before you touch them.

6. If your model is an EliteDesk 800 95W, remove the fan assembly.
 - a. Disconnect the fan assembly plug (1) from the system board.
 - b. Loosen the three captive screws securing the fan assembly (2).
 - c. Lift the fan assembly out of the chassis (3).

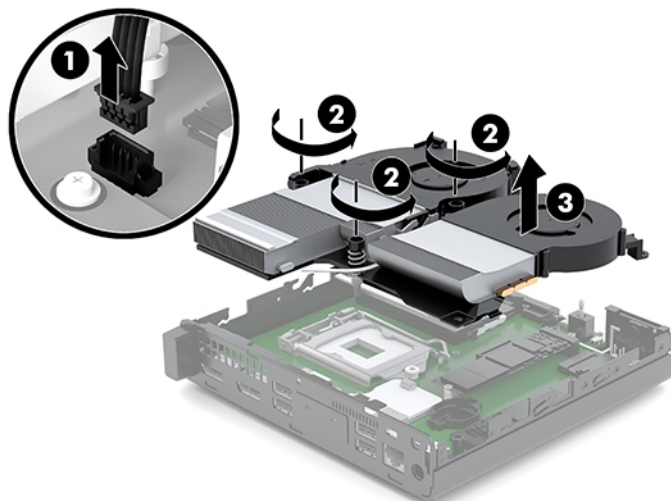

7. Locate the WLAN module on the system board.

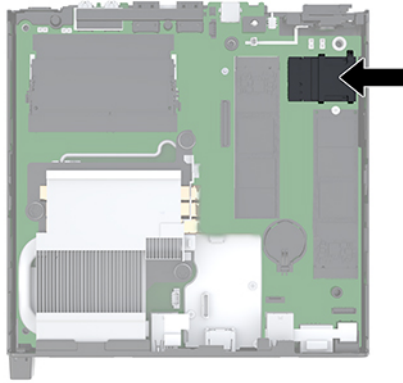

8. Disconnect the internal antennas from the WLAN module.
For instructions, see [Replacing the WLAN module on page 24](#).
9. Locate both external antenna positions on the rear of the chassis.
10. To view the knock-out feature on the left side of the rear panel, remove the antenna cover by pushing down on the antenna cover (1) and pulling it away (2) from the panel.
11. Insert a Phillips screwdriver into each knock-out feature and rotate (3) to remove the blank.

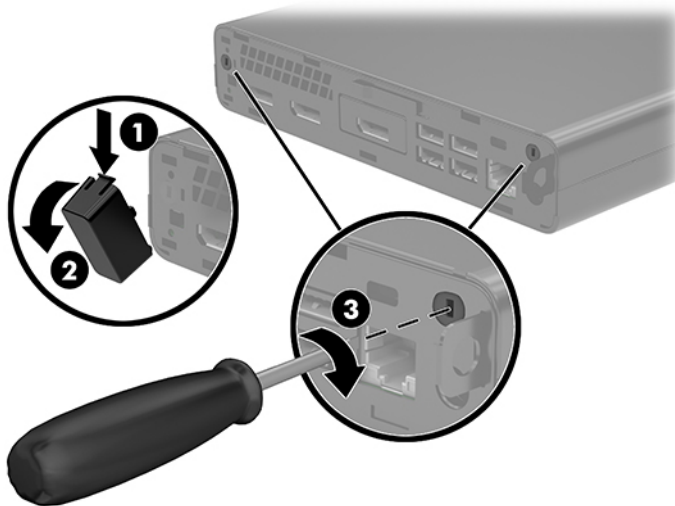

12. Feed the external antenna cable through each hole (1) and tighten the nut (2) to secure the cable.

13. Connect the external antenna (3) and screw into place (4).

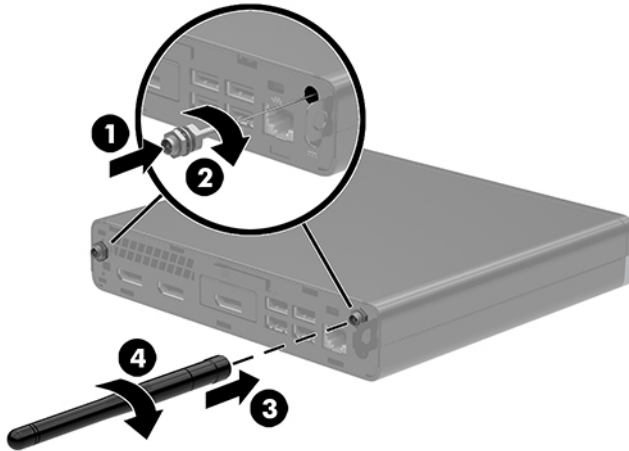

14. If your model is an EliteDesk 800 95W, replace the fan assembly.
- Set the fan assembly in place (1).
 - Tighten the three captive screws to secure the fan assembly to the chassis (2).
 - Connect the fan assembly plug to the system board (3).

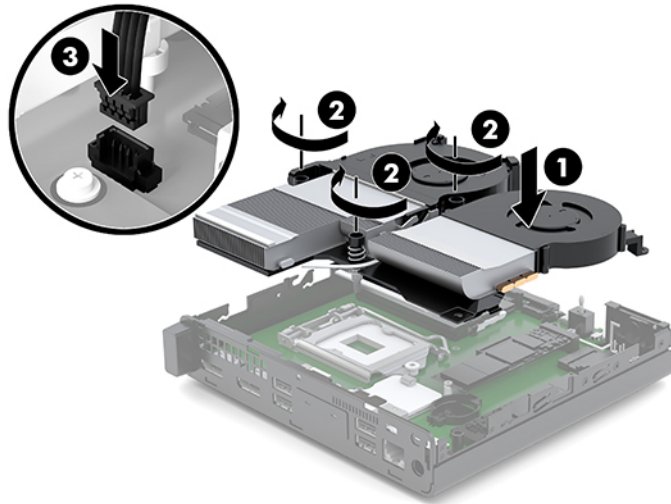

15. Install the access panel.
- For instructions on installing the access panel on a 35W model, see [Installing the access panel of the HP EliteDesk 800 35W on page 13](#).
 - For instructions on installing the access panel on any other model, see [Installing the access panel on page 11](#).
16. If the computer was on a stand, replace the stand.

17. Reconnect external devices, plug in the power cord, and then turn on the computer.
18. Lock any security devices that were disengaged when the access panel was removed.

Replacing the battery

The battery that comes with the computer provides power to the real-time clock. When replacing the battery, use a battery equivalent to the battery originally installed in the computer. The computer comes with a 3-volt lithium coin cell battery.

 **WARNING!** The computer contains an internal lithium manganese dioxide battery. There is a risk of fire and burns if the battery is not handled properly. To reduce the risk of personal injury:

Do not attempt to recharge the battery.

Do not expose to temperatures higher than 60°C (140°F).

Do not disassemble, crush, puncture, short external contacts, or dispose of in fire or water.

Replace the battery only with the HP spare designated for this product.

 **CAUTION:** Before replacing the battery, it is important to back up the computer CMOS settings. When the battery is removed or replaced, the CMOS settings will be cleared.

Static electricity can damage the electronic components of the computer or optional equipment. Before beginning these procedures, ensure that you are discharged of static electricity by briefly touching a grounded metal object.

 **NOTE:** The lifetime of the lithium battery can be extended by plugging the computer into a live AC wall socket. The lithium battery is only used when the computer is NOT connected to AC power.

HP encourages customers to recycle used electronic hardware, HP original print cartridges, and rechargeable batteries. For more information about recycling programs, go to <http://www.hp.com/recycle>.

1. Remove/disengage any security devices that prohibit opening the computer.
2. Remove all removable media, such as a USB flash drive, from the computer.
3. Turn off the computer properly through the operating system, then turn off any external devices.
4. Disconnect the power cord from the AC outlet and disconnect any external devices.

 **CAUTION:** Regardless of the power-on state, voltage is always present on the system board as long as the system is plugged into an active AC outlet. You must disconnect the power cord to avoid damage to the internal components of the computer.

5. Remove the access panel.
 - For instructions on removing the access panel from a 35W model, see [Removing the access panel of the HP EliteDesk 800 35W on page 11](#).
 - For instructions on removing the access panel from any other model, see [Removing the access panel on page 10](#).

 **WARNING!** To reduce risk of personal injury from hot surfaces, allow the internal system components to cool before you touch them.

6. If your model is an EliteDesk 800 95W, remove the fan assembly.

- a. Disconnect the fan assembly plug (1) from the system board.
- b. Loosen the three captive screws securing the fan assembly (2).
- c. Lift the fan assembly out of the chassis (3).

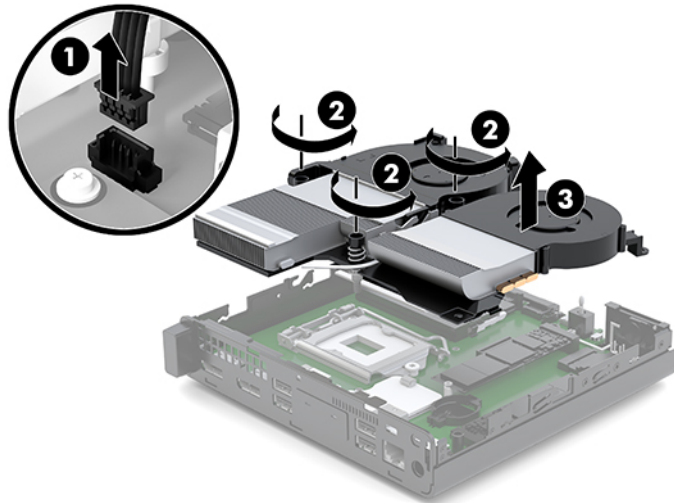

7. Locate the battery and battery holder on the system board.

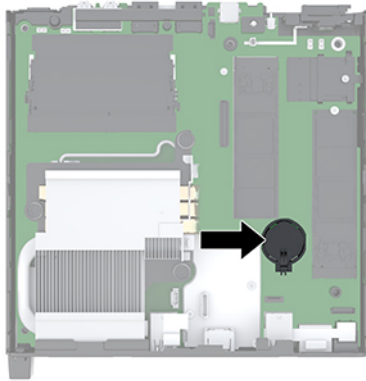

 **NOTE:** You may need to use a small tool, such as tweezers or needle-nose pliers, to remove and replace the battery.

8. To release the battery from its holder, squeeze the metal clamp that extends above one edge of the battery (1). When the battery pops up, lift it out (2).



9. To insert the new battery, slide one edge of the replacement battery into the holder with the positive side up (1). Push the other edge down until the clamp snaps over the other edge of the battery (2).



10. If your model is an EliteDesk 800 95W, replace the fan assembly.
 - a. Set the fan assembly in place (1).
 - b. Tighten the three captive screws to secure the fan assembly to the chassis (2).

- c. Connect the fan assembly plug to the system board (3).

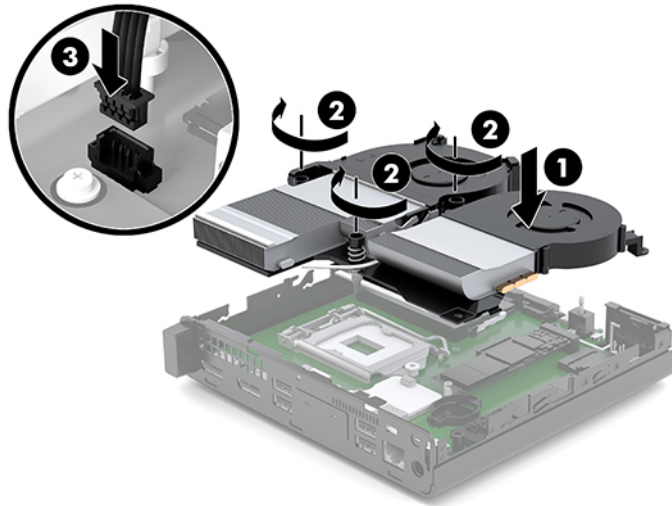

11. Replace the access panel.

- For instructions on installing the access panel on a 35W model, see [Installing the access panel of the HP EliteDesk 800 35W on page 13](#).
- For instructions on installing the access panel on any other model, see [Installing the access panel on page 11](#).

12. If the computer was on a stand, replace the stand.

13. Reconnect external devices, plug in the power cord, and then turn on the computer.

14. Lock any security devices that were disengaged when the computer access panel was removed.

15. Reset the date and time, your passwords, and any special system setups using Computer Setup.

Synchronizing the optional wireless keyboard and mouse

The mouse and keyboard are synchronized at the factory. If they do not work, remove and replace the batteries. If the mouse and keyboard are still not synchronized, then follow this procedure to manually re-synchronize the pair.

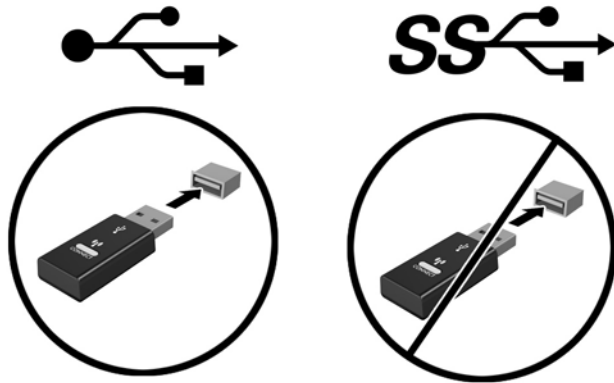

1.

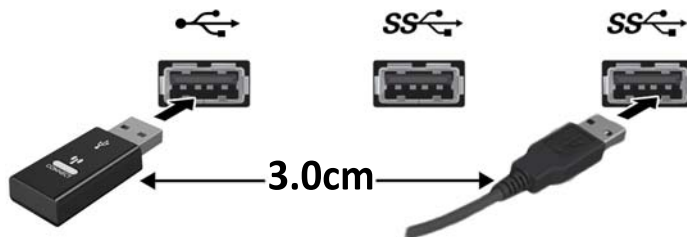

2.

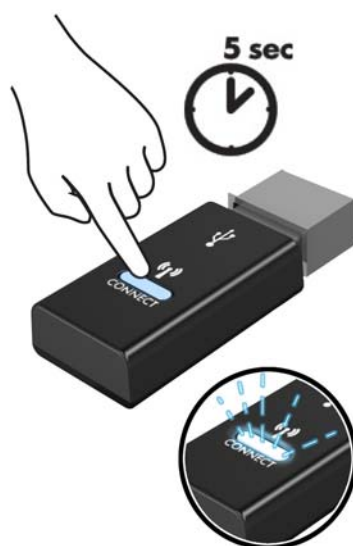

3.

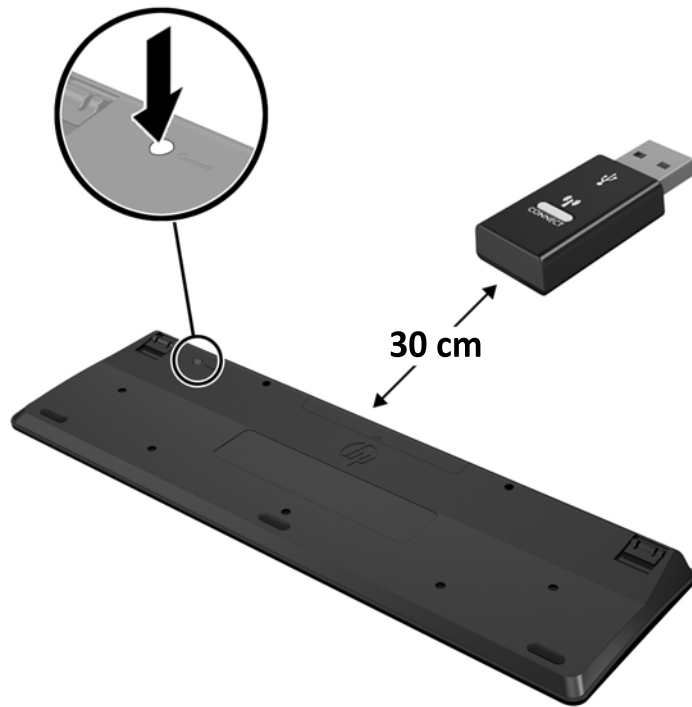

4.



5.

 **NOTE:** If the mouse and keyboard still do not work, then remove and replace the batteries. If the mouse and keyboard are still not synchronized, then synchronize the keyboard and mouse again.

A Electrostatic discharge

A discharge of static electricity from a finger or other conductor may damage system boards or other static-sensitive devices. This type of damage may reduce the life expectancy of the device.

Preventing electrostatic damage

To prevent electrostatic damage, observe the following precautions:

- Avoid hand contact by transporting and storing products in static-safe containers.
- Keep electrostatic-sensitive parts in their containers until they arrive at static-free workstations.
- Place parts on a grounded surface before removing them from their containers.
- Avoid touching pins, leads, or circuitry.
- Always be properly grounded when touching a static-sensitive component or assembly.

Grounding methods

There are several methods for grounding. Use one or more of the following methods when handling or installing electrostatic-sensitive parts:

- Use a wrist strap connected by a ground cord to a grounded workstation or computer chassis. Wrist straps are flexible straps with a minimum of 1 megohm +/- 10 percent resistance in the ground cords. To provide proper ground, wear the strap snug against the skin.
- Use heelstraps, toestraps, or bootstraps at standing workstations. Wear the straps on both feet when standing on conductive floors or dissipating floor mats.
- Use conductive field service tools.
- Use a portable field service kit with a folding static-dissipating work mat.

If you do not have any of the suggested equipment for proper grounding, contact an HP authorized dealer, reseller, or service provider.



NOTE: For more information on static electricity, contact an HP authorized dealer, reseller, or service provider.

B Computer operating guidelines, routine care and shipping preparation

Computer operating guidelines and routine care

Follow these guidelines to properly set up and care for the computer and monitor:

- Keep the computer away from excessive moisture, direct sunlight, and extremes of heat and cold.
- Operate the computer on a sturdy, level surface. Leave a 10.2 cm (4 inch) clearance on all vented sides of the computer and above the monitor to permit the required airflow.
- Never restrict the airflow into the computer by blocking any vents or air intakes. Do not place the keyboard, with the keyboard feet down, directly against the front of the desktop unit as this also restricts airflow.
- Never operate the computer with the access panel or any of the expansion card slot covers removed.
- Do not stack computers on top of each other or place computers so near each other that they are subject to each other's re-circulated or preheated air.
- If the computer is to be operated within a separate enclosure, intake and exhaust ventilation must be provided on the enclosure, and the same operating guidelines listed above will still apply.
- Keep liquids away from the computer and keyboard.
- Never cover the ventilation slots on the monitor with any type of material.
- Install or enable power management functions of the operating system or other software, including sleep states.
- Turn off the computer before you do either of the following:
 - Wipe the exterior of the computer with a soft, damp cloth as needed. Using cleaning products may discolor or damage the finish.
 - Occasionally clean the air vents on all vented sides of the computer. Lint, dust, and other foreign matter can block the vents and limit the airflow.

Shipping preparation

Follow these suggestions when preparing to ship the computer:

1. Back up the SSD files to an external storage device. Be sure that the backup media is not exposed to electrical or magnetic impulses while stored or in transit.
2. Remove and store all removable media.
3. Turn off the computer and external devices.
4. Disconnect the power cord from the AC outlet, then from the computer.
5. Disconnect the system components and external devices from their power sources, then from the computer.



NOTE: Ensure that all boards are seated properly and secured in the board slots before shipping the computer.

6. Pack the system components and external devices in their original packing boxes or similar packaging with sufficient packing material to protect them.

C Accessibility

HP designs, produces, and markets products and services that can be used by everyone, including people with disabilities, either on a stand-alone basis or with appropriate assistive devices.

Supported assistive technologies

HP products support a wide variety of operating system assistive technologies and can be configured to work with additional assistive technologies. Use the Search feature on your device to locate more information about assistive features.



NOTE: For additional information about a particular assistive technology product, contact customer support for that product.

Contacting support

We are constantly refining the accessibility of our products and services and welcome feedback from users. If you have an issue with a product or would like to tell us about accessibility features that have helped you, please contact us at (888) 259-5707, Monday through Friday, 6 a.m. to 9 p.m. Mountain Time. If you are deaf or hard-of-hearing and use TRS/VRS/WebCapTel, contact us if you require technical support or have accessibility questions by calling (877) 656-7058, Monday through Friday, 6 a.m. to 9 p.m. North American Mountain Time.



NOTE: Support is in English only.

Index

- A**
 - access panel
 - installing 11
 - removal 10
 - accessibility 39
 - antenna connector, external 4
 - antenna cover 4
 - audio-out (headphone)/audio-in (microphone) combo jack 2, 3
- B**
 - battery
 - removal 30
 - replacement 30
 - battery replacement 30
 - buttons
 - power 2, 3
- C**
 - computer operating guidelines 37
 - connectors
 - external antenna 4
 - power 4
- D**
 - DisplayPort 4
 - Dual-Mode DisplayPort 4
- E**
 - electrostatic discharge, preventing
 - damage 36
 - external antenna
 - installation 27
- F**
 - fan assembly
 - removal 21, 24, 27, 30
 - replacement 23, 26, 29, 32
 - front panel components 2
 - EliteDesk 800 2
- H**
 - ProDesk 400 3
 - ProDesk 600 2
- H**
 - hard drive
 - installation 19, 20
 - removal 19, 20
 - headphone jack 2, 3
- I**
 - installation guidelines 9
 - installing
 - access panel 11
 - battery 30
 - external 27
 - hard drive 19, 20
 - memory modules 16
 - security cable 8
 - solid-state drive 21
 - system memory 14
 - WLAN module 24
- J**
 - jacks
 - audio-out (headphone)/audio-in (microphone) combo 2, 3
 - headphone 2, 3
 - RJ-45 (network) 4
- K**
 - keyboard
 - synchronizing wireless 34
- L**
 - LED, main storage 2, 3
- M**
 - main storage LED 2, 3
 - memory modules
 - maximum 14
 - removal 16
 - replacement 16
 - slots 14
 - socket population 15
 - specifications 14
 - memory, system
 - installing 14
 - mounting the computer 7
- mouse**
 - synchronizing wireless 34
- P**
 - padlock loop 4
 - ports
 - DisplayPort 4
 - Dual-Mode DisplayPort 4
 - HDMI 4
 - serial 4
 - Thunderbolt 4
 - USB 2, 4
 - USB SuperSpeed port with HP Sleep and Charge* 2
 - USB Type-C alternate mode 4
 - USB Type-C SuperSpeed 3
 - USB Type-C SuperSpeed port with HP Sleep and Charge* 3
 - USB Type-C SuperSpeed with HP Sleep and Charge 2
 - VGA 4
 - power button, dual-state 2, 3
 - power connector 4
 - power cord connection 8
 - product ID location 5
- R**
 - rear panel components 4
 - removal
 - battery 30

- removing
 - access panel 10
 - battery 30
 - hard drive 19, 20
 - memory modules 16
 - solid-state drive 21
 - WLAN module 24
- RJ-45 (network) jack 4

S

- security cable
 - installation 8
- security cable slot 4
- serial number location 5
- shipping preparation 38
- slots
 - security cable 4
- solid-state drive
 - removal 21
 - replacement 21
- specifications, memory modules 14
- status lights
 - RJ-45 (network) 4
- synchronizing wireless keyboard and mouse 34

T

- thumbscrew 4
- tower conversion 6

U

- USB ports 4
- USB SuperSpeed port 2, 4
- USB SuperSpeed port with HP Sleep and Charge* 2
- USB Type-C SuperSpeed port 3
- USB Type-C SuperSpeed port with HP Sleep and Charge 2
- USB Type-C SuperSpeed port with HP Sleep and Charge* 3

V

- ventilation guidelines 37
- VESA mounting holes 7

W

- WLAN module
 - removal 24
 - replacement 24