



iB4100 series Online Manual

Printer Functions
Overview
Printing
Troubleshooting

Contents

Using This Online Manual.	15
Trademarks and Licenses.	16
Search Tips.	25
Using the Printer.	27
Printing Documents from Your Computer (Windows).	28
Printing Documents from Your Computer (Mac OS).	31
Printer Functions.	35
Printing from an AirPrint-enabled Printer.	36
Printing from an AirPrint-enabled Printer with Mac.	37
Printing from an AirPrint-enabled Printer with iOS Device.	39
Connect Wirelessly in "Direct Connection".	43
Download a Variety of Content Materials.	44
Print Items with Easy-PhotoPrint+ (Web Application).	45
Managing Printer Conveniently Using Quick Utility Toolbox.	46
Available Connection Methods.	47
Using PIXMA/MAXIFY Cloud Link.	49
Notice for Web Service Printing.	50
Using PIXMA/MAXIFY Cloud Link from Your Smartphone, Tablet, or Computer.	51
Before Using Canon Inkjet Cloud Printing Center.	52
Requirements for Canon Inkjet Cloud Printing Center operation.	53
Registering User Information to Canon Inkjet Cloud Printing Center.	55
Registering User Information to Canon Inkjet Cloud Printing Center (Color LCD Monitor).	56
Registering User Information to Canon Inkjet Cloud Printing Center (Monochrome LCD Monitor).	64
Registering User Information to Canon Inkjet Cloud Printing Center (No LCD Monitor/Using PRO-1000 series or PRO-500 series).	73
Using Canon Inkjet Cloud Printing Center.	80
Canon Inkjet Cloud Printing Center window.	84
Adding a Printer.	123
Adding a PIXMA/MAXIFY Cloud Link User.	126
Troubleshooting Canon Inkjet Cloud Printing Center.	132

Print Easily from a Smartphone or Tablet with Canon PRINT Inkjet/SELPHY.	135
Printing with Windows RT.	136
Handling Paper, Ink Tanks, etc..	137
Loading Paper.	138
Paper Sources.	139
Loading Plain Paper / Photo Paper.	142
Loading Envelopes.	148
Replacing Ink Tanks.	153
Replacing Ink Tanks.	154
Checking Ink Status on the LCD.	159
Maintenance.	160
If Printing Is Faint or Uneven.	161
Maintenance Procedure.	162
Printing the Nozzle Check Pattern.	164
Examining the Nozzle Check Pattern.	165
Cleaning the Print Head.	166
Deep Print Head Cleaning.	167
Aligning the Print Head.	168
Performing Maintenance Functions from Your Computer (Windows).	170
Cleaning the Print Heads.	171
Aligning the Print Head Position.	173
Aligning the Print Head Position Manually.	174
Printing a Nozzle Check Pattern.	177
Cleaning.	178
Cleaning Exterior Surfaces.	179
Cleaning Paper Feed Rollers.	180
Cleaning Inside the Printer (Bottom Plate Cleaning).	182
Cleaning Cassette Pads.	184
Overview.	185
Safety.	187
Safety Precautions.	188
Regulatory Information.	189

WEEE (EU&EEA)	192
Main Components and Their Use.	202
Main Components.	203
Front View.	204
Rear View.	205
Inside View.	206
Operation Panel.	207
Power Supply.	208
Confirming that the Power Is On.	209
Turning the Printer On and Off.	210
Checking the Power Plug/Power Cord.	212
Unplugging the Printer.	213
LCD and Operation Panel.	214
Changing Settings.	216
Changing Printer Settings from Your Computer (Windows).	217
Changing the Print Options.	218
Registering a Frequently Used Printing Profile.	220
Managing the Printer Power.	222
Reducing the Printer Noise.	224
Changing the Printer Operation Mode.	226
Changing Settings from Operation Panel.	228
Changing Settings from Operation Panel.	229
Setting Items on Operation Panel.	230
Output settings.	231
LAN settings.	232
Dev. user settings.	235
Timezone List.	237
Firmware update.	239
Cassette settings.	240
Reset setting.	241
Web service setup.	242
System information.	243
Quiet setting.	244
Turning on/off Printer Automatically.	245
Changing Printer's Setting Using Web Browser.	247

Changing Settings Using Web Browser.	248
Registering Printer's Root Certificate to Web Browser.	251
Changeable Setting Items Using Web Browser.	255
Setting Password.	257
Setting Mail Server.	259
Receiving Printer Status by E-mail.	261
Network Connection.	263
Network Connection Tips.	264
Default Network Settings.	265
Another Printer Found with Same Name.	267
Connecting to Another Computer via LAN/Changing from USB to LAN Connection.	268
Printing Network Settings.	269
Changing LAN Connection Method/Changing Wireless LAN Connection Method.	274
Network Settings (IJ Network Device Setup Utility) (Windows).	276
IJ Network Device Setup Utility.	277
Starting Up IJ Network Device Setup Utility.	278
IJ Network Device Setup Utility Screen.	279
Performing Network Settings.	284
Performing/Changing Wired LAN Settings.	285
Performing/Changing Wireless LAN Settings.	288
Assigning Printer Information.	292
Initializing Network Settings.	293
Changing Administrator Password.	294
Setting Criteria for Printer Search/Searching Specific Printer.	295
If WEP Details Screen Appears.	297
If WPA/WPA2 Details Screen Appears.	298
Checking Network Status.	299
Checking Wireless Network Status.	300
Displaying Computer Network Information.	301
Displaying Printer Network Information.	302
Checking Connection Status between Printer and Wireless Router.	303
Checking Network Setting Difference.	304
IJ Network Device Setup Utility Menus.	305
Printer Menu.	306
View Menu.	308

Option Menu.	310
Help Menu.	311
Other Network Information.	312
Technical Terms.	313
Restrictions.	320
Firewall.	321
Ensuring Optimal Printing Results.	322
Ink Tips.	323
Printing Tips.	324
Check Paper Settings Before Printing.	325
Set Cassette Paper Information After Loading Paper.	326
Canceling Print Jobs.	327
Keeping Print Quality High.	328
Transporting Your Printer.	329
Legal Restrictions on Printing.	330
Specifications.	331
Information about Paper.	334
Supported Media Types.	335
Paper Load Limit.	337
Unsupported Media Types.	339
Handling Paper.	340
Print Area.	341
Print Area.	342
Standard Sizes.	343
Envelopes.	345
Administrator Settings.	346
Sharing the Printer on a Network.	347
Setting Up a Shared Printer.	348
Restrictions on Printer Sharing.	350
Administrator Password.	352
Password and Cookie.	354
How to locate your printer's serial number.	356

Registering Root Certificate to Web Browser.	357
Printing.	358
Printing from Computer.	359
Printing from Application Software (Windows Printer Driver).	360
Printing with Easy Setup.	361
Paper Settings on the Printer Driver and the Printer (Media Type).	365
Paper Settings on the Printer Driver and the Printer (Paper Size).	366
Various Printing Methods.	367
Setting a Page Size and Orientation.	368
Setting the Number of Copies and Printing Order.	369
Setting the Stapling Margin.	371
Fit-to-Page Printing.	373
Scaled Printing.	375
Page Layout Printing.	378
Tiling/Poster Printing.	380
Booklet Printing.	383
Duplex Printing.	385
Stamp/Background Printing.	389
Setting Up Envelope Printing.	398
Printing on Postcards.	400
Switching the Paper Source to Match the Purpose.	402
Displaying the Print Results before Printing.	404
Setting Paper Dimensions (Custom Size).	405
Editing the Print Document or Reprinting from the Print History.	407
Changing the Print Quality and Correcting Image Data.	411
Printing a Color Document in Monochrome.	412
Specifying Color Correction.	414
Adjusting Color Balance.	422
Adjusting Color Balance Using Sample Patterns (Printer Driver).	424
Adjusting Brightness.	428
Adjusting Intensity.	430
Adjusting Contrast.	432
Adjusting Intensity/Contrast Using Sample Patterns (Printer Driver).	434
Overview of the Printer Driver.	438
Canon IJ Printer Driver.	439

Canon IJ Status Monitor.	441
Canon IJ Preview.	443
Deleting the Undesired Print Job.	444
Instructions for Use (Printer Driver).	445
Printer Driver Description.	447
Quick Setup tab Description.	448
Main tab Description.	454
Page Setup tab Description.	459
Maintenance tab Description.	472
Canon IJ Preview Description.	479
Canon IJ XPS Preview Description.	482
Canon IJ Status Monitor Description.	491
Updating the Printer Driver.	494
Obtaining the Latest Printer Driver.	495
Deleting the Unnecessary Printer Driver.	496
Before Installing the Printer Driver.	497
Installing the Printer Driver.	498
Printing Using a Web Service.	499
Using PIXMA/MAXIFY Cloud Link.	49
Printing with Google Cloud Print.	501
Getting Google Account.	503
Registering Printer with Google Cloud Print.	504
Printing from Computer or Smartphone with Google Cloud Print.	507
Deleting Printer from Google Cloud Print.	511
Printing from an AirPrint-enabled Printer with Mac.	37
Printing from a Device Equipped with Windows 10 Mobile.	515
Printing from Smartphone/Tablet.	516
Printing Directly from Smartphone/Tablet.	517
Android Print.	518
Printing from an AirPrint-enabled Printer with iOS Device.	39
Using Printer with Direct Connection.	524
Printing Using a Web Service.	528
Using PIXMA/MAXIFY Cloud Link.	49
Printing with Google Cloud Print.	501
Paper Settings.	532

Using PIXMA/MAXIFY Cloud Link	49
Troubleshooting	536
Network Communication Problems	538
Cannot Find Printer on Network	539
Cannot Find Printer on Check Printer Settings Screen	540
Check 1: Cannot Find Printer on Check Printer Settings Screen During Wireless LAN Setup. .	541
Check 2: Cannot Find Printer on Check Printer Settings Screen During Wireless LAN Setup. .	542
Check 3: Cannot Find Printer on Check Printer Settings Screen During Wireless LAN Setup. .	543
Check 4: Cannot Find Printer on Check Printer Settings Screen During Wireless LAN Setup. .	545
Check 5: Cannot Find Printer on Check Printer Settings Screen During Wireless LAN Setup. .	546
Check 6: Cannot Find Printer on Check Printer Settings Screen During Wireless LAN Setup. .	547
Check 1: Cannot Find Printer on Check Printer Settings Screen During Wired LAN Setup.	548
Check 2: Cannot Find Printer on Check Printer Settings Screen During Wired LAN Setup.	549
Check 3: Cannot Find Printer on Check Printer Settings Screen During Wired LAN Setup.	550
Check 4: Cannot Find Printer on Check Printer Settings Screen During Wired LAN Setup.	551
Check 5: Cannot Find Printer on Check Printer Settings Screen During Wired LAN Setup.	552
Check 6: Cannot Find Printer on Check Printer Settings Screen During Wired LAN Setup.	553
Cannot Find Printer after Searching it on Printer Detection Screen During Setup	554
Searching Printer by IP Address or Host Name During Setup (Windows)	556
Cannot Proceed beyond Printer Connection Screen/Connect Cable Screen	558
Cannot Find Printer while Using Wireless LAN	560
Cannot Find Printer while Using Wired LAN	563
Network Connection Problems	564
Printer Suddenly Cannot Be Used	565
Network Key Unknown	569
Administrator Password Set for Printer Unknown	571
Printer Cannot Be Used After Replacing Wireless Router or Changing Its Settings	572
Printing Is Slow	574
Cannot Access to Internet on Wireless LAN from Communication Device	575
Ink Level Not Shown on Printer Status Monitor (Windows)	576
Other Network Problems	577

Message Appears on Computer During Setup.	578
Checking Network Information.	580
Restoring to Factory Defaults.	583
Problems while Printing from Smartphone/Tablet.	584
Cannot Print from Smartphone/Tablet.	585
Printing Problems.	588
Printing Does Not Start.	589
Paper Jams.	592
Print Results Are Unsatisfactory.	594
Cannot Complete Printing.	595
Part of Page Is Not Printed (Windows).	596
Paper Is Blank/Printing Is Blurry/Colors Are Wrong/White Streaks Appear.	597
Lines Are Misaligned.	599
Lines Incomplete or Missing (Windows).	600
Images Incomplete or Missing (Windows).	601
Ink Blots / Paper Curl.	602
Paper Is Smudged / Printed Surface Is Scratched.	603
Back of Paper Is Smudged.	607
Uneven or Streaked Colors.	608
No Ink Comes Out.	610
Paper Does Not Feed Properly/"No Paper" Error.	611
Automatic Duplex Printing Problems.	613
Printing Stops.	615
Cannot Print Using AirPrint.	616
Mechanical Problems.	617
Power Does Not Come On.	618
Power Shuts Off By Itself.	619
USB Connection Problems.	620
Cannot Communicate with Printer via USB.	621
LCD Is Off.	622
LCD Shows Wrong Language.	623
Print Head Holder Does Not Move to Replacement Position.	624
Printer Status Monitor Not Displayed (Windows).	625
Installation and Download Problems.	626
Cannot Install Printer Driver.	627

Easy-WebPrint EX Does Not Start or Easy-WebPrint EX Menu Does Not Appear (Windows)	629
Updating Printer Driver in Network Environment (Windows)	630
Errors and Messages	631
An Error Occurs	632
Message Appears	634
If You Cannot Solve a Problem	641
List of Support Code for Error	642
List of Support Code for Error (Paper Jams)	644
1300	645
1303	648
1313	650
1314	653
Other Cases	655
1007	656
1008	657
1200	658
1309	659
1310	660
1319	661
1575	662
1600	663
1660	664
1688	665
1700	666
1701	667
1754	668
1755	669
1872	670
1873	671
1874	672
1890	673
2111	674

2112.	676
2113.	678
2121.	680
2122.	681
2500.	682
3413.	683
3426.	684
3427.	685
3428.	686
3429.	687
3430.	688
3431.	689
3432.	690
3433.	691
4100.	692
4103.	693
4104.	694
5100.	695
5102.	696
5103.	697
5104.	698
5105.	699
5200.	700
5203.	701
5204.	702
5205.	703
5206.	704
5207.	705
5208.	706
5209.	707
5400.	708
5500.	709
5501.	710

5B00.....	711
5B01.....	712
5C01.....	713
6000.....	714
6500.....	715
6502.....	716
6800.....	717
6801.....	718
6900.....	719
6901.....	720
6902.....	721
6910.....	722
6911.....	723
6920.....	724
6921.....	725
6930.....	726
6931.....	727
6932.....	728
6933.....	729
6940.....	730
6941.....	731
6942.....	732
6943.....	733
6944.....	734
6945.....	735
6946.....	736
7100.....	737
7200.....	738
7201.....	739
7202.....	740
7203.....	741
7204.....	742
7205.....	743

B202.....	744
B203.....	745
B204.....	746
B205.....	747
B502.....	748
B503.....	749
B504.....	750
C000.....	751

Using This Online Manual

- [Symbols Used in This Document](#)
- [Touch-enabled Device Users \(Windows\)](#)

Symbols Used in This Document

Warning

Instructions that, if ignored, could result in death or serious personal injury caused by incorrect operation of the equipment. These must be observed for safe operation.

Caution

Instructions that, if ignored, could result in personal injury or material damage caused by incorrect operation of the equipment. These must be observed for safe operation.

Important

Instructions including important information. To avoid damage and injury or improper use of the product, be sure to read these indications.

Note

Instructions including notes for operation and additional explanations.

Basics

Instructions explaining basic operations of your product.

Note

-
- Icons may vary depending on your product.
-

Touch-enabled Device Users (Windows)

For touch actions, you need to replace "right-click" in this document with the action set on the operating system. For example, if the action is set to "press and hold" on your operating system, replace "right-click" with "press and hold."

Trademarks and Licenses

- Microsoft is a registered trademark of Microsoft Corporation.
- Windows is a trademark or registered trademark of Microsoft Corporation in the U.S. and/or other countries.
- Windows Vista is a trademark or registered trademark of Microsoft Corporation in the U.S. and/or other countries.
- Internet Explorer is a trademark or registered trademark of Microsoft Corporation in the U.S. and/or other countries.
- Mac, Mac OS, AirPort, Safari, Bonjour, iPad, iPhone and iPod touch are trademarks of Apple Inc., registered in the U.S. and other countries. App Store, AirPrint and the AirPrint logo are trademarks of Apple Inc.
- IOS is a trademark or registered trademark of Cisco in the U.S. and other countries and is used under license.
- Google Cloud Print, Google Chrome, Chrome OS, Chromebook, Android, Google Play, Google Drive, Google Apps and Picasa are either registered trademarks or trademarks of Google Inc.
- Adobe, Flash, Photoshop, Photoshop Elements, Lightroom, Adobe RGB and Adobe RGB (1998) are either registered trademarks or trademarks of Adobe Systems Incorporated in the United States and/or other countries.
- Bluetooth is a trademark of Bluetooth SIG, Inc., U.S.A. and licensed to Canon Inc.
- Autodesk and AutoCAD are registered trademarks or trademarks of Autodesk, Inc., and/or its subsidiaries and/or affiliates in the USA and/or other countries.

»» Note

- The formal name of Windows Vista is Microsoft Windows Vista operating system.

Copyright (c) 2003-2004, Apple Computer, Inc. All rights reserved.

Redistribution and use in source and binary forms, with or without modification, are permitted provided that the following conditions are met:

1. Redistributions of source code must retain the above copyright notice, this list of conditions and the following disclaimer.
2. Redistributions in binary form must reproduce the above copyright notice, this list of conditions and the following disclaimer in the documentation and/or other materials provided with the distribution.
3. Neither the name of Apple Computer, Inc. ("Apple") nor the names of its contributors may be used to endorse or promote products derived from this software without specific prior written permission.

THIS SOFTWARE IS PROVIDED BY APPLE AND ITS CONTRIBUTORS "AS IS" AND ANY EXPRESS OR IMPLIED WARRANTIES, INCLUDING, BUT NOT LIMITED TO, THE IMPLIED WARRANTIES OF MERCHANTABILITY AND FITNESS FOR A PARTICULAR PURPOSE ARE DISCLAIMED. IN NO EVENT SHALL APPLE OR ITS CONTRIBUTORS BE LIABLE FOR ANY DIRECT, INDIRECT, INCIDENTAL, SPECIAL, EXEMPLARY, OR CONSEQUENTIAL DAMAGES (INCLUDING, BUT NOT LIMITED TO, PROCUREMENT OF SUBSTITUTE GOODS OR SERVICES; LOSS OF USE, DATA, OR PROFITS; OR BUSINESS INTERRUPTION) HOWEVER CAUSED AND ON ANY THEORY OF LIABILITY, WHETHER IN CONTRACT, STRICT LIABILITY, OR TORT INCLUDING NEGLIGENCE OR OTHERWISE) ARISING IN ANY WAY OUT OF THE USE OF THIS SOFTWARE, EVEN IF ADVISED OF THE POSSIBILITY OF SUCH DAMAGE.

Apache License

Version 2.0, January 2004

<http://www.apache.org/licenses/>

TERMS AND CONDITIONS FOR USE, REPRODUCTION, AND DISTRIBUTION

1. Definitions.

"License" shall mean the terms and conditions for use, reproduction, and distribution as defined by Sections 1 through 9 of this document.

"Licensor" shall mean the copyright owner or entity authorized by the copyright owner that is granting the License.

"Legal Entity" shall mean the union of the acting entity and all other entities that control, are controlled by, or are under common control with that entity. For the purposes of this definition, "control" means (i) the power, direct or indirect, to cause the direction or management of such entity, whether by contract or otherwise, or (ii) ownership of fifty percent (50%) or more of the outstanding shares, or (iii) beneficial ownership of such entity.

"You" (or "Your") shall mean an individual or Legal Entity exercising permissions granted by this License.

"Source" form shall mean the preferred form for making modifications, including but not limited to software source code, documentation source, and configuration files.

"Object" form shall mean any form resulting from mechanical transformation or translation of a Source form, including but not limited to compiled object code, generated documentation, and conversions to other media types.

"Work" shall mean the work of authorship, whether in Source or Object form, made available under the License, as indicated by a copyright notice that is included in or attached to the work (an example is provided in the Appendix below).

"Derivative Works" shall mean any work, whether in Source or Object form, that is based on (or derived from) the Work and for which the editorial revisions, annotations, elaborations, or other modifications represent, as a whole, an original work of authorship. For the purposes of this License, Derivative Works shall not include works that remain separable from, or merely link (or bind by name) to the interfaces of, the Work and Derivative Works thereof.

"Contribution" shall mean any work of authorship, including the original version of the Work and any modifications or additions to that Work or Derivative Works thereof, that is intentionally submitted to Licensor for inclusion in the Work by the copyright owner or by an individual or Legal Entity authorized to submit on behalf of the copyright owner. For the purposes of this definition, "submitted" means any form of electronic, verbal, or written communication sent to the Licensor or its representatives, including but not limited to communication on electronic mailing lists, source code control systems, and issue tracking systems that are managed by, or on behalf of, the Licensor for the purpose of discussing and improving the Work, but excluding communication that is conspicuously marked or otherwise designated in writing by the copyright owner as "Not a Contribution."

"Contributor" shall mean Licensor and any individual or Legal Entity on behalf of whom a Contribution has been received by Licensor and subsequently incorporated within the Work.

2. Grant of Copyright License. Subject to the terms and conditions of this License, each Contributor hereby grants to You a perpetual, worldwide, non-exclusive, no-charge, royalty-free, irrevocable

copyright license to reproduce, prepare Derivative Works of, publicly display, publicly perform, sublicense, and distribute the Work and such Derivative Works in Source or Object form.

3. Grant of Patent License. Subject to the terms and conditions of this License, each Contributor hereby grants to You a perpetual, worldwide, non-exclusive, no-charge, royalty-free, irrevocable (except as stated in this section) patent license to make, have made, use, offer to sell, sell, import, and otherwise transfer the Work, where such license applies only to those patent claims licensable by such Contributor that are necessarily infringed by their Contribution(s) alone or by combination of their Contribution(s) with the Work to which such Contribution(s) was submitted. If You institute patent litigation against any entity (including a cross-claim or counterclaim in a lawsuit) alleging that the Work or a Contribution incorporated within the Work constitutes direct or contributory patent infringement, then any patent licenses granted to You under this License for that Work shall terminate as of the date such litigation is filed.
4. Redistribution. You may reproduce and distribute copies of the Work or Derivative Works thereof in any medium, with or without modifications, and in Source or Object form, provided that You meet the following conditions:
 1. You must give any other recipients of the Work or Derivative Works a copy of this License; and
 2. You must cause any modified files to carry prominent notices stating that You changed the files; and
 3. You must retain, in the Source form of any Derivative Works that You distribute, all copyright, patent, trademark, and attribution notices from the Source form of the Work, excluding those notices that do not pertain to any part of the Derivative Works; and
 4. If the Work includes a "NOTICE" text file as part of its distribution, then any Derivative Works that You distribute must include a readable copy of the attribution notices contained within such NOTICE file, excluding those notices that do not pertain to any part of the Derivative Works, in at least one of the following places: within a NOTICE text file distributed as part of the Derivative Works; within the Source form or documentation, if provided along with the Derivative Works; or, within a display generated by the Derivative Works, if and wherever such third-party notices normally appear. The contents of the NOTICE file are for informational purposes only and do not modify the License. You may add Your own attribution notices within Derivative Works that You distribute, alongside or as an addendum to the NOTICE text from the Work, provided that such additional attribution notices cannot be construed as modifying the License.

You may add Your own copyright statement to Your modifications and may provide additional or different license terms and conditions for use, reproduction, or distribution of Your modifications, or for any such Derivative Works as a whole, provided Your use, reproduction, and distribution of the Work otherwise complies with the conditions stated in this License.

5. Submission of Contributions. Unless You explicitly state otherwise, any Contribution intentionally submitted for inclusion in the Work by You to the Licensor shall be under the terms and conditions of this License, without any additional terms or conditions. Notwithstanding the above, nothing herein shall supersede or modify the terms of any separate license agreement you may have executed with Licensor regarding such Contributions.
6. Trademarks. This License does not grant permission to use the trade names, trademarks, service marks, or product names of the Licensor, except as required for reasonable and customary use in describing the origin of the Work and reproducing the content of the NOTICE file.
7. Disclaimer of Warranty. Unless required by applicable law or agreed to in writing, Licensor provides the Work (and each Contributor provides its Contributions) on an "AS IS" BASIS, WITHOUT WARRANTIES OR CONDITIONS OF ANY KIND, either express or implied, including, without

limitation, any warranties or conditions of TITLE, NON-INFRINGEMENT, MERCHANTABILITY, or FITNESS FOR A PARTICULAR PURPOSE. You are solely responsible for determining the appropriateness of using or redistributing the Work and assume any risks associated with Your exercise of permissions under this License.

8. Limitation of Liability. In no event and under no legal theory, whether in tort (including negligence), contract, or otherwise, unless required by applicable law (such as deliberate and grossly negligent acts) or agreed to in writing, shall any Contributor be liable to You for damages, including any direct, indirect, special, incidental, or consequential damages of any character arising as a result of this License or out of the use or inability to use the Work (including but not limited to damages for loss of goodwill, work stoppage, computer failure or malfunction, or any and all other commercial damages or losses), even if such Contributor has been advised of the possibility of such damages.
9. Accepting Warranty or Additional Liability. While redistributing the Work or Derivative Works thereof, You may choose to offer, and charge a fee for, acceptance of support, warranty, indemnity, or other liability obligations and/or rights consistent with this License. However, in accepting such obligations, You may act only on Your own behalf and on Your sole responsibility, not on behalf of any other Contributor, and only if You agree to indemnify, defend, and hold each Contributor harmless for any liability incurred by, or claims asserted against, such Contributor by reason of your accepting any such warranty or additional liability.

END OF TERMS AND CONDITIONS

---- Part 1: CMU/UCD copyright notice: (BSD like) ----

Copyright 1989, 1991, 1992 by Carnegie Mellon University

Derivative Work - 1996, 1998-2000

Copyright 1996, 1998-2000 The Regents of the University of California

All Rights Reserved

Permission to use, copy, modify and distribute this software and its documentation for any purpose and without fee is hereby granted, provided that the above copyright notice appears in all copies and that both that copyright notice and this permission notice appear in supporting documentation, and that the name of CMU and The Regents of the University of California not be used in advertising or publicity pertaining to distribution of the software without specific written permission.

CMU AND THE REGENTS OF THE UNIVERSITY OF CALIFORNIA DISCLAIM ALL WARRANTIES WITH REGARD TO THIS SOFTWARE, INCLUDING ALL IMPLIED WARRANTIES OF MERCHANTABILITY AND FITNESS. IN NO EVENT SHALL CMU OR THE REGENTS OF THE UNIVERSITY OF CALIFORNIA BE LIABLE FOR ANY SPECIAL, INDIRECT OR CONSEQUENTIAL DAMAGES OR ANY DAMAGES WHATSOEVER RESULTING FROM THE LOSS OF USE, DATA OR PROFITS, WHETHER IN AN ACTION OF CONTRACT, NEGLIGENCE OR OTHER TORTIOUS ACTION, ARISING OUT OF OR IN CONNECTION WITH THE USE OR PERFORMANCE OF THIS SOFTWARE.

---- Part 2: Networks Associates Technology, Inc copyright notice (BSD) ----

Copyright (c) 2001-2003, Networks Associates Technology, Inc

All rights reserved.

Redistribution and use in source and binary forms, with or without modification, are permitted provided that the following conditions are met:

- * Redistributions of source code must retain the above copyright notice, this list of conditions and the following disclaimer.
- * Redistributions in binary form must reproduce the above copyright notice, this list of conditions and the following disclaimer in the documentation and/or other materials provided with the distribution.
- * Neither the name of the Networks Associates Technology, Inc nor the names of its contributors may be used to endorse or promote products derived from this software without specific prior written permission.

THIS SOFTWARE IS PROVIDED BY THE COPYRIGHT HOLDERS AND CONTRIBUTORS ``AS IS" AND ANY EXPRESS OR IMPLIED WARRANTIES, INCLUDING, BUT NOT LIMITED TO, THE IMPLIED WARRANTIES OF MERCHANTABILITY AND FITNESS FOR A PARTICULAR PURPOSE ARE DISCLAIMED. IN NO EVENT SHALL THE COPYRIGHT HOLDERS OR CONTRIBUTORS BE LIABLE FOR ANY DIRECT, INDIRECT, INCIDENTAL, SPECIAL, EXEMPLARY, OR CONSEQUENTIAL DAMAGES (INCLUDING, BUT NOT LIMITED TO, PROCUREMENT OF SUBSTITUTE GOODS OR SERVICES; LOSS OF USE, DATA, OR PROFITS; OR BUSINESS INTERRUPTION) HOWEVER CAUSED AND ON ANY THEORY OF LIABILITY, WHETHER IN CONTRACT, STRICT LIABILITY, OR TORT (INCLUDING NEGLIGENCE OR OTHERWISE) ARISING IN ANY WAY OUT OF THE USE OF THIS SOFTWARE, EVEN IF ADVISED OF THE POSSIBILITY OF SUCH DAMAGE.

---- Part 3: Cambridge Broadband Ltd. copyright notice (BSD) -----

Portions of this code are copyright (c) 2001-2003, Cambridge Broadband Ltd.

All rights reserved.

Redistribution and use in source and binary forms, with or without modification, are permitted provided that the following conditions are met:

- * Redistributions of source code must retain the above copyright notice, this list of conditions and the following disclaimer.
- * Redistributions in binary form must reproduce the above copyright notice, this list of conditions and the following disclaimer in the documentation and/or other materials provided with the distribution.
- * The name of Cambridge Broadband Ltd. may not be used to endorse or promote products derived from this software without specific prior written permission.

THIS SOFTWARE IS PROVIDED BY THE COPYRIGHT HOLDER ``AS IS" AND ANY EXPRESS OR IMPLIED WARRANTIES, INCLUDING, BUT NOT LIMITED TO, THE IMPLIED WARRANTIES OF MERCHANTABILITY AND FITNESS FOR A PARTICULAR PURPOSE ARE DISCLAIMED. IN NO EVENT SHALL THE COPYRIGHT HOLDER BE LIABLE FOR ANY DIRECT, INDIRECT, INCIDENTAL, SPECIAL, EXEMPLARY, OR CONSEQUENTIAL DAMAGES (INCLUDING, BUT NOT LIMITED TO, PROCUREMENT OF SUBSTITUTE GOODS OR SERVICES; LOSS OF USE, DATA, OR PROFITS; OR BUSINESS INTERRUPTION) HOWEVER CAUSED AND ON ANY THEORY OF LIABILITY, WHETHER IN CONTRACT, STRICT LIABILITY, OR TORT (INCLUDING NEGLIGENCE OR OTHERWISE) ARISING IN ANY WAY OUT OF THE USE OF THIS SOFTWARE, EVEN IF ADVISED OF THE POSSIBILITY OF SUCH DAMAGE.

---- Part 4: Sun Microsystems, Inc. copyright notice (BSD) -----

Copyright c 2003 Sun Microsystems, Inc., 4150 Network Circle, Santa Clara, California 95054, U.S.A. All rights reserved.

Use is subject to license terms below.

This distribution may include materials developed by third parties.

Sun, Sun Microsystems, the Sun logo and Solaris are trademarks or registered trademarks of Sun Microsystems, Inc. in the U.S. and other countries.

Redistribution and use in source and binary forms, with or without modification, are permitted provided that the following conditions are met:

- * Redistributions of source code must retain the above copyright notice, this list of conditions and the following disclaimer.
- * Redistributions in binary form must reproduce the above copyright notice, this list of conditions and the following disclaimer in the documentation and/or other materials provided with the distribution.
- * Neither the name of the Sun Microsystems, Inc. nor the names of its contributors may be used to endorse or promote products derived from this software without specific prior written permission.

THIS SOFTWARE IS PROVIDED BY THE COPYRIGHT HOLDERS AND CONTRIBUTORS ``AS IS'' AND ANY EXPRESS OR IMPLIED WARRANTIES, INCLUDING, BUT NOT LIMITED TO, THE IMPLIED WARRANTIES OF MERCHANTABILITY AND FITNESS FOR A PARTICULAR PURPOSE ARE DISCLAIMED. IN NO EVENT SHALL THE COPYRIGHT HOLDERS OR CONTRIBUTORS BE LIABLE FOR ANY DIRECT, INDIRECT, INCIDENTAL, SPECIAL, EXEMPLARY, OR CONSEQUENTIAL DAMAGES (INCLUDING, BUT NOT LIMITED TO, PROCUREMENT OF SUBSTITUTE GOODS OR SERVICES; LOSS OF USE, DATA, OR PROFITS; OR BUSINESS INTERRUPTION) HOWEVER CAUSED AND ON ANY THEORY OF LIABILITY, WHETHER IN CONTRACT, STRICT LIABILITY, OR TORT (INCLUDING NEGLIGENCE OR OTHERWISE) ARISING IN ANY WAY OUT OF THE USE OF THIS SOFTWARE, EVEN IF ADVISED OF THE POSSIBILITY OF SUCH DAMAGE.

---- Part 5: Sparta, Inc copyright notice (BSD) ----

Copyright (c) 2003-2009, Sparta, Inc

All rights reserved.

Redistribution and use in source and binary forms, with or without modification, are permitted provided that the following conditions are met:

- * Redistributions of source code must retain the above copyright notice, this list of conditions and the following disclaimer.
- * Redistributions in binary form must reproduce the above copyright notice, this list of conditions and the following disclaimer in the documentation and/or other materials provided with the distribution.
- * Neither the name of Sparta, Inc nor the names of its contributors may be used to endorse or promote products derived from this software without specific prior written permission.

THIS SOFTWARE IS PROVIDED BY THE COPYRIGHT HOLDERS AND CONTRIBUTORS ``AS IS'' AND ANY EXPRESS OR IMPLIED WARRANTIES, INCLUDING, BUT NOT LIMITED TO, THE IMPLIED WARRANTIES OF MERCHANTABILITY AND FITNESS FOR A PARTICULAR PURPOSE ARE DISCLAIMED. IN NO EVENT SHALL THE COPYRIGHT HOLDERS OR CONTRIBUTORS BE LIABLE FOR ANY DIRECT, INDIRECT, INCIDENTAL, SPECIAL, EXEMPLARY, OR CONSEQUENTIAL DAMAGES (INCLUDING, BUT NOT LIMITED TO, PROCUREMENT OF SUBSTITUTE GOODS OR SERVICES; LOSS OF USE, DATA, OR PROFITS; OR BUSINESS INTERRUPTION) HOWEVER CAUSED AND ON ANY THEORY OF LIABILITY, WHETHER IN CONTRACT, STRICT LIABILITY, OR TORT (INCLUDING NEGLIGENCE OR OTHERWISE) ARISING IN ANY WAY OUT OF THE USE OF THIS SOFTWARE, EVEN IF ADVISED OF THE POSSIBILITY OF SUCH DAMAGE.

---- Part 6: Cisco/BUPTNIC copyright notice (BSD) ----

Copyright (c) 2004, Cisco, Inc and Information Network Center of Beijing University of Posts and Telecommunications.

All rights reserved.

Redistribution and use in source and binary forms, with or without modification, are permitted provided that the following conditions are met:

- * Redistributions of source code must retain the above copyright notice, this list of conditions and the following disclaimer.
- * Redistributions in binary form must reproduce the above copyright notice, this list of conditions and the following disclaimer in the documentation and/or other materials provided with the distribution.
- * Neither the name of Cisco, Inc, Beijing University of Posts and Telecommunications, nor the names of their contributors may be used to endorse or promote products derived from this software without specific prior written permission.

THIS SOFTWARE IS PROVIDED BY THE COPYRIGHT HOLDERS AND CONTRIBUTORS ``AS IS" AND ANY EXPRESS OR IMPLIED WARRANTIES, INCLUDING, BUT NOT LIMITED TO, THE IMPLIED WARRANTIES OF MERCHANTABILITY AND FITNESS FOR A PARTICULAR PURPOSE ARE DISCLAIMED. IN NO EVENT SHALL THE COPYRIGHT HOLDERS OR CONTRIBUTORS BE LIABLE FOR ANY DIRECT, INDIRECT, INCIDENTAL, SPECIAL, EXEMPLARY, OR CONSEQUENTIAL DAMAGES (INCLUDING, BUT NOT LIMITED TO, PROCUREMENT OF SUBSTITUTE GOODS OR SERVICES; LOSS OF USE, DATA, OR PROFITS; OR BUSINESS INTERRUPTION) HOWEVER CAUSED AND ON ANY THEORY OF LIABILITY, WHETHER IN CONTRACT, STRICT LIABILITY, OR TORT (INCLUDING NEGLIGENCE OR OTHERWISE) ARISING IN ANY WAY OUT OF THE USE OF THIS SOFTWARE, EVEN IF ADVISED OF THE POSSIBILITY OF SUCH DAMAGE.

---- Part 7: Fabasoft R&D Software GmbH & Co KG copyright notice (BSD) ----

Copyright (c) Fabasoft R&D Software GmbH & Co KG, 2003 oss@fabasoft.com

Author: Bernhard Penz

Redistribution and use in source and binary forms, with or without modification, are permitted provided that the following conditions are met:

- * Redistributions of source code must retain the above copyright notice, this list of conditions and the following disclaimer.
- * Redistributions in binary form must reproduce the above copyright notice, this list of conditions and the following disclaimer in the documentation and/or other materials provided with the distribution.
- * The name of Fabasoft R&D Software GmbH & Co KG or any of its subsidiaries, brand or product names may not be used to endorse or promote products derived from this software without specific prior written permission.

THIS SOFTWARE IS PROVIDED BY THE COPYRIGHT HOLDER ``AS IS" AND ANY EXPRESS OR IMPLIED WARRANTIES, INCLUDING, BUT NOT LIMITED TO, THE IMPLIED WARRANTIES OF MERCHANTABILITY AND FITNESS FOR A PARTICULAR PURPOSE ARE DISCLAIMED. IN NO EVENT SHALL THE COPYRIGHT HOLDER BE LIABLE FOR ANY DIRECT, INDIRECT, INCIDENTAL, SPECIAL, EXEMPLARY, OR CONSEQUENTIAL DAMAGES (INCLUDING, BUT NOT LIMITED TO, PROCUREMENT OF SUBSTITUTE GOODS OR SERVICES; LOSS OF USE, DATA, OR PROFITS; OR BUSINESS INTERRUPTION) HOWEVER CAUSED AND ON ANY THEORY OF LIABILITY, WHETHER

IN CONTRACT, STRICT LIABILITY, OR TORT (INCLUDING NEGLIGENCE OR OTHERWISE) ARISING IN ANY WAY OUT OF THE USE OF THIS SOFTWARE, EVEN IF ADVISED OF THE POSSIBILITY OF SUCH DAMAGE.

LEADTOOLS

Copyright (C) 1991-2009 LEAD Technologies, Inc.

CMap Resources

Copyright 1990-2009 Adobe Systems Incorporated.
All rights reserved.

Copyright 1990-2010 Adobe Systems Incorporated.
All rights reserved.

Redistribution and use in source and binary forms, with or without modification, are permitted provided that the following conditions are met:

Redistributions of source code must retain the above copyright notice, this list of conditions and the following disclaimer.

Redistributions in binary form must reproduce the above copyright notice, this list of conditions and the following disclaimer in the documentation and/or other materials provided with the distribution.

Neither the name of Adobe Systems Incorporated nor the names of its contributors may be used to endorse or promote products derived from this software without specific prior written permission.

THIS SOFTWARE IS PROVIDED BY THE COPYRIGHT HOLDERS AND CONTRIBUTORS "AS IS" AND ANY EXPRESS OR IMPLIED WARRANTIES, INCLUDING, BUT NOT LIMITED TO, THE IMPLIED WARRANTIES OF MERCHANTABILITY AND FITNESS FOR A PARTICULAR PURPOSE ARE DISCLAIMED. IN NO EVENT SHALL THE COPYRIGHT HOLDER OR CONTRIBUTORS BE LIABLE FOR ANY DIRECT, INDIRECT, INCIDENTAL, SPECIAL, EXEMPLARY, OR CONSEQUENTIAL DAMAGES (INCLUDING, BUT NOT LIMITED TO, PROCUREMENT OF SUBSTITUTE GOODS OR SERVICES; LOSS OF USE, DATA, OR PROFITS; OR BUSINESS INTERRUPTION) HOWEVER CAUSED AND ON ANY THEORY OF LIABILITY, WHETHER IN CONTRACT, STRICT LIABILITY, OR TORT (INCLUDING NEGLIGENCE OR OTHERWISE) ARISING IN ANY WAY OUT OF THE USE OF THIS SOFTWARE, EVEN IF ADVISED OF THE POSSIBILITY OF SUCH DAMAGE.

MIT License

Copyright (c) 1998, 1999, 2000 Thai Open Source Software Center Ltd

Permission is hereby granted, free of charge, to any person obtaining a copy of this software and associated documentation files (the "Software"), to deal in the Software without restriction, including without limitation the rights to use, copy, modify, merge, publish, distribute, sublicense, and/or sell copies of the Software, and to permit persons to whom the Software is furnished to do so, subject to the following conditions:

The above copyright notice and this permission notice shall be included in all copies or substantial portions of the Software.

THE SOFTWARE IS PROVIDED "AS IS", WITHOUT WARRANTY OF ANY KIND, EXPRESS OR IMPLIED, INCLUDING BUT NOT LIMITED TO THE WARRANTIES OF MERCHANTABILITY, FITNESS FOR A PARTICULAR PURPOSE AND NONINFRINGEMENT. IN NO EVENT SHALL THE AUTHORS OR COPYRIGHT HOLDERS BE LIABLE FOR ANY CLAIM, DAMAGES OR OTHER LIABILITY, WHETHER IN AN ACTION OF CONTRACT, TORT OR OTHERWISE, ARISING FROM, OUT OF OR IN CONNECTION WITH THE SOFTWARE OR THE USE OR OTHER DEALINGS IN THE SOFTWARE.

The following applies only to products supporting Wi-Fi.

(c) 2009-2013 by Jeff Mott. All rights reserved.

Redistribution and use in source and binary forms, with or without modification, are permitted provided that the following conditions are met:

- * Redistributions of source code must retain the above copyright notice, this list of conditions, and the following disclaimer.
- * Redistributions in binary form must reproduce the above copyright notice, this list of conditions, and the following disclaimer in the documentation or other materials provided with the distribution.
- * Neither the name CryptoJS nor the names of its contributors may be used to endorse or promote products derived from this software without specific prior written permission.

THIS SOFTWARE IS PROVIDED BY THE COPYRIGHT HOLDERS AND CONTRIBUTORS "AS IS," AND ANY EXPRESS OR IMPLIED WARRANTIES, INCLUDING, BUT NOT LIMITED TO, THE IMPLIED WARRANTIES OF MERCHANTABILITY AND FITNESS FOR A PARTICULAR PURPOSE, ARE DISCLAIMED. IN NO EVENT SHALL THE COPYRIGHT HOLDER OR CONTRIBUTORS BE LIABLE FOR ANY DIRECT, INDIRECT, INCIDENTAL, SPECIAL, EXEMPLARY, OR CONSEQUENTIAL DAMAGES (INCLUDING, BUT NOT LIMITED TO, PROCUREMENT OF SUBSTITUTE GOODS OR SERVICES; LOSS OF USE, DATA, OR PROFITS; OR BUSINESS INTERRUPTION) HOWEVER CAUSED AND ON ANY THEORY OF LIABILITY, WHETHER IN CONTRACT, STRICT LIABILITY, OR TORT (INCLUDING NEGLIGENCE OR OTHERWISE) ARISING IN ANY WAY OUT OF THE USE OF THIS SOFTWARE, EVEN IF ADVISED OF THE POSSIBILITY OF SUCH DAMAGE.

Enter keywords in the search window and click  (Search).

You can search for target pages in this guide.

Entry example: "(your product's model name) load paper"

Search Tips

You can search for target pages by entering keywords in the search window.

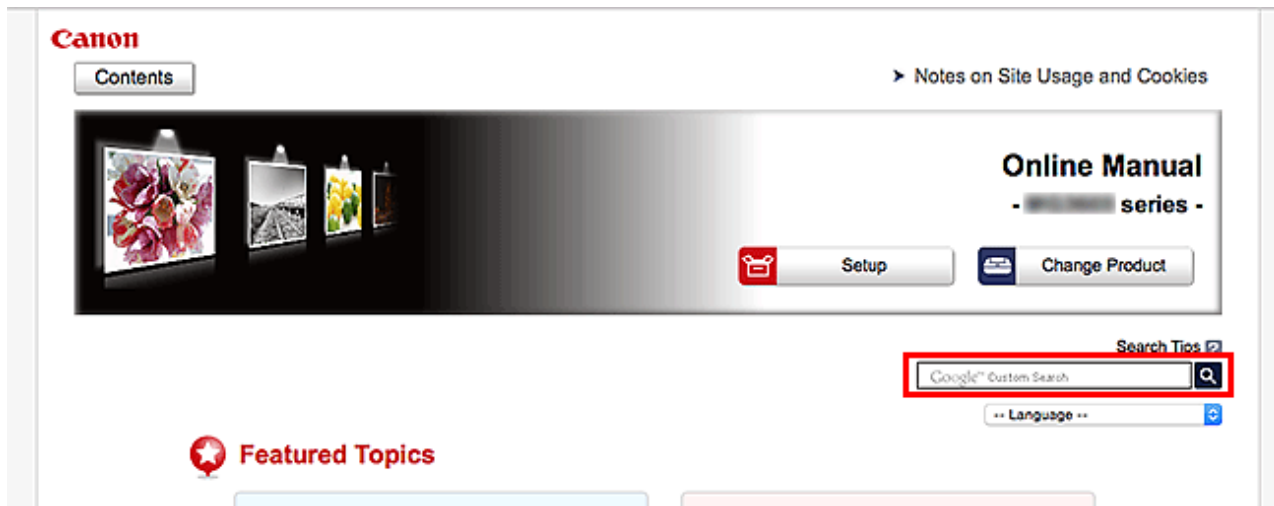

►►► Important

- This function may not be available in some countries/regions.

►►► Note

- The displayed screen may vary.
- When searching from this page without entering your product's model name or your application's name, all products supported by this guide will be considered for the search.
If you want to narrow down the search results, add your product's model name or your application's name to the keywords.

• Searching for Functions

Enter your product's model name and a keyword for the function you want to learn about

Example: When you want to learn how to load paper

Enter "(your product's model name) load paper" in the search window and perform a search

• Troubleshooting Errors

Enter your product's model name and a support code

Example: When the following error screen appears

Enter "(your product's model name) 1003" in the search window and perform a search

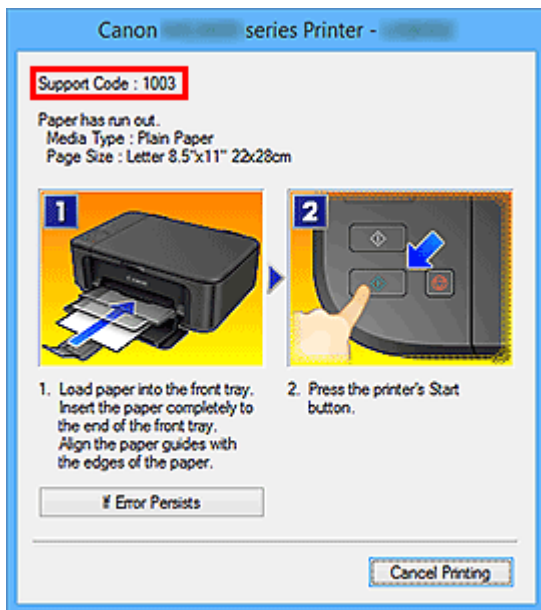

►►► Note

- The displayed screen varies depending on your product.

• **Searching for Application Functions**

Enter your application's name and a keyword for the function you want to learn about

Example: When you want to learn how to print collages with My Image Garden

Enter "My Image Garden collage" in the search window and perform a search

• **Searching for Reference Pages**

Enter your model name and a reference page title*

* You can find reference pages more easily by entering the function name as well.

Example: When you want to browse the page referred to by the following sentence on a scanning procedure page

Refer to "Color Settings Tab" for your model from Home of the Online Manual for details.

Enter "(your product's model name) scan Color Settings Tab" in the search window and perform a search

Using the Printer

- ▶ [Printing Documents from Your Computer \(Windows\)](#)
- ▶ [Printing Documents from Your Computer \(Mac OS\)](#)

Printing Documents from Your Computer (Windows)

Print documents from applications on a computer or other device as follows.

1. Pull out a cassette.



2. Load paper printing-side DOWN.
3. Align the paper guides with the paper length and width.

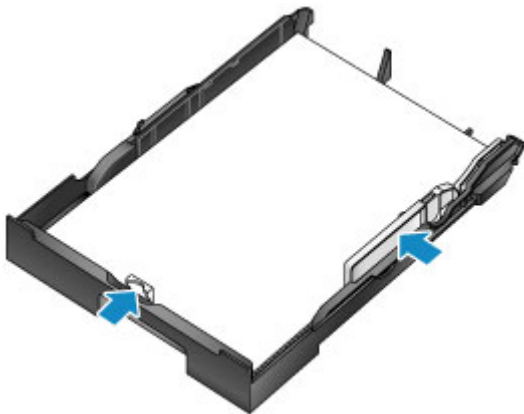

4. Insert the cassette.

After you insert the cassette, a screen for registering paper information for the cassette is displayed on the LCD.

5. Press the **OK** button.

```
Register cassette 1 pape  
[OK]Next
```

6. Use the ◀ or ▶ button to select the size of paper in the cassette, and then press the **OK** button.

Size: ◀ *A4 ▶
Type: *PlusGlossyII

7. Use the ◀ or ▶ button to select the type of paper in the cassette, and then press the **OK** button.

Size: *A4
Type: Plain paper ▶

8. Pull out the output tray extension (A) and open the paper output support (B).



9. In the application, select **Print**.

You can often access the **Print** dialog box by selecting **Print** in the **File** menu.

10. Select the model name and click **Preferences** (or **Properties**).

Printer driver settings are displayed.

▶▶▶ Note

- Command and menu names vary by application, and printing may involve more steps. For detailed instructions, refer to the application user manual.

11. Select a typical printing profile.

In **Commonly Used Settings** on the **Quick Setup** tab, select a profile that suits the purpose of printing.

Once you select a printing profile, preset values are automatically applied to **Additional Features**, **Media Type**, and **Printer Paper Size** settings.

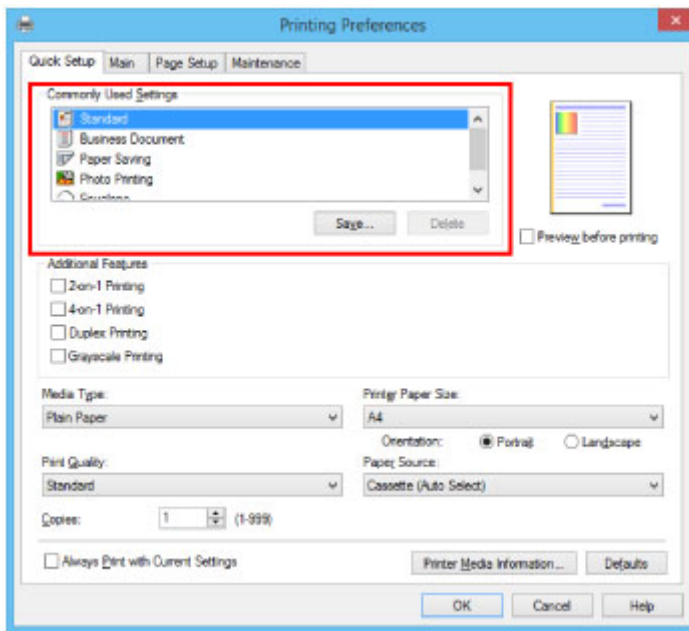

12. Select the paper source.

In **Paper Source**, select the cassette where the paper is loaded.

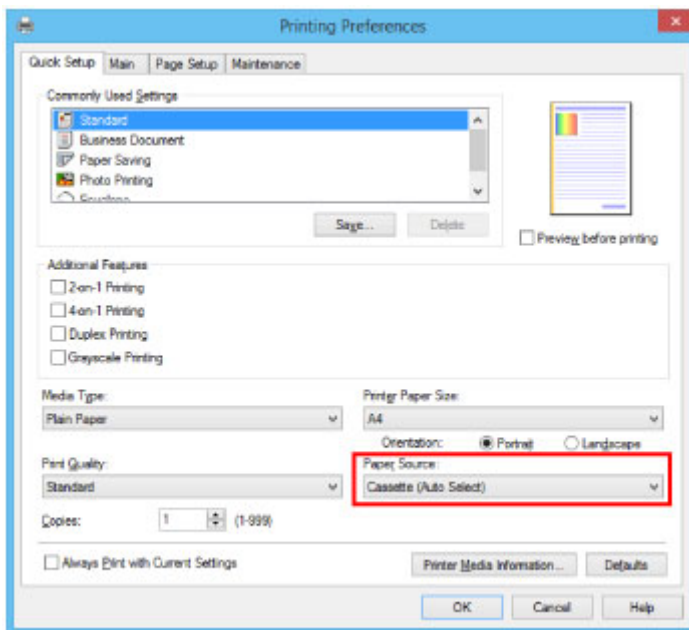

13. Once the print settings are complete, click **OK** to print.

▶▶▶ Note

- A variety of print settings can be configured with the printer driver.

■ [Printing from Application Software \(Windows Printer Driver\)](#)

Printing Documents from Your Computer (Mac OS)

Print documents from applications on a computer or other device as follows.

1. Pull out a cassette.



2. Load paper printing-side DOWN.
3. Align the paper guides with the paper length and width.

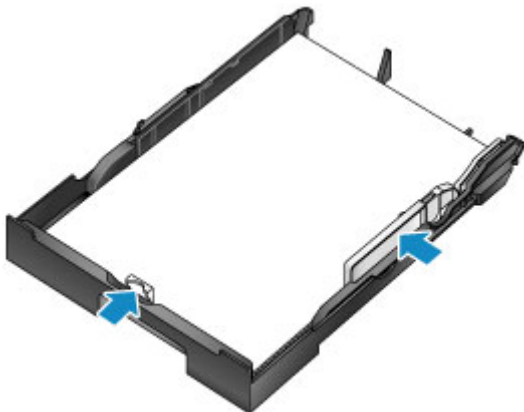

4. Insert the cassette.

After you insert the cassette, a screen for registering paper information for the cassette is displayed on the LCD.

5. Press the **OK** button.

```
Register cassette 1 pape  
[OK]Next
```

6. Use the ◀ or ▶ button to select the size of paper in the cassette, and then press the **OK** button.

Size: ◀ *A4 ▶
Type: *PlusGlossyII

7. Use the ◀ or ▶ button to select the type of paper in the cassette, and then press the **OK** button.

Size: *A4
Type: Plain paper ▶

8. Pull out the output tray extension (A) and open the paper output support (B).



9. In the application, select **Print**.

You can often access the Print dialog by selecting **Print...** in the **File** menu.

▶▶▶ **Note**

- For detailed instructions on operation, refer to the application user manual.

10. Select the model name and click **Printer** list.

Click **Show Details** to switch the Setup window to the detailed display.

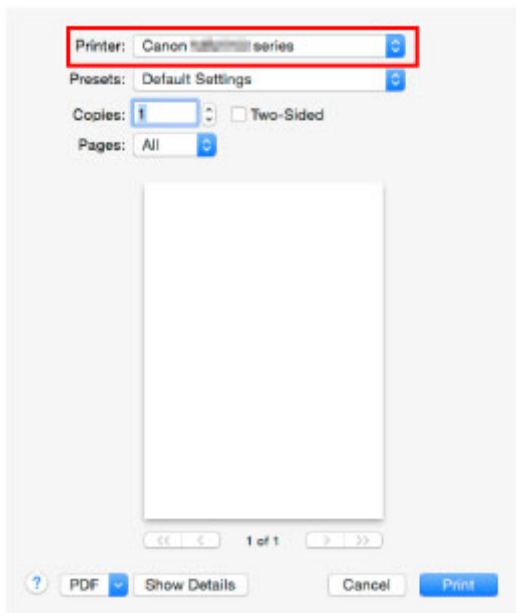

11. Select the paper size.

In **Paper Size**, select the paper size you use.

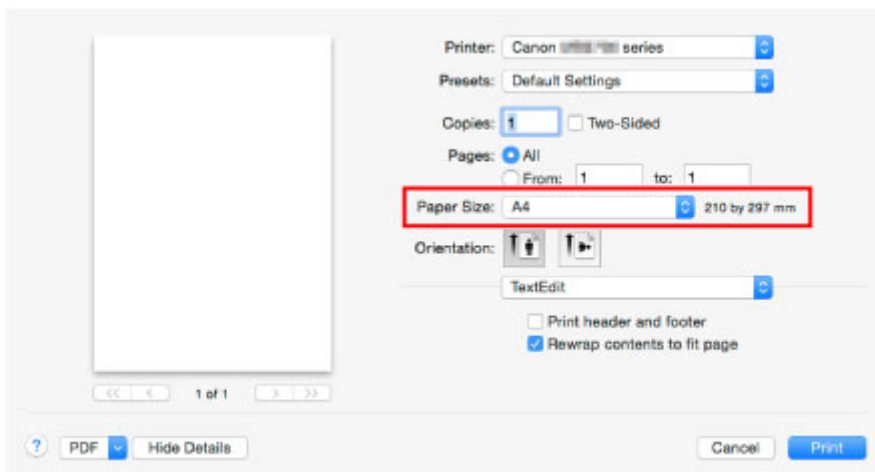

12. Select **Quality & Media** from the pop-up menu.

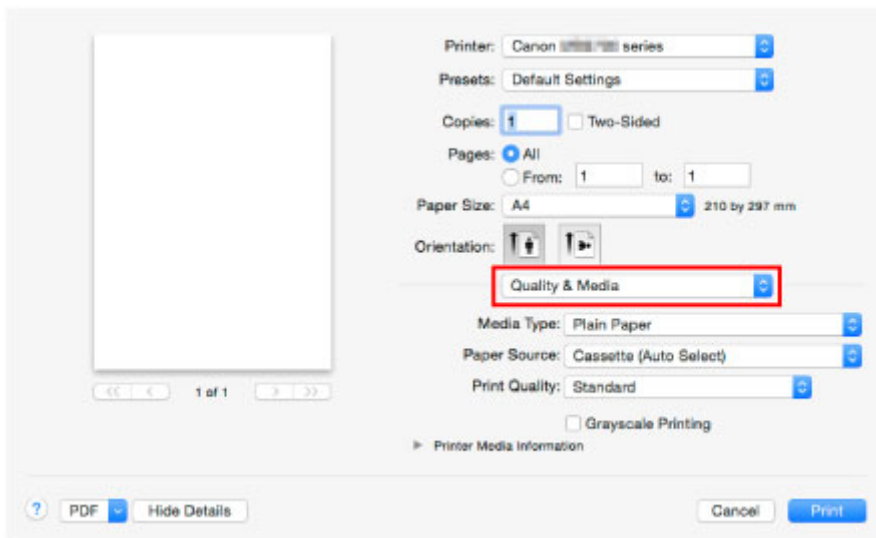

13. Select the media type.

In **Media Type**, select the same media type loaded in the printer.

14. Select the paper source.

In **Paper Source**, select the cassette where the paper is loaded.

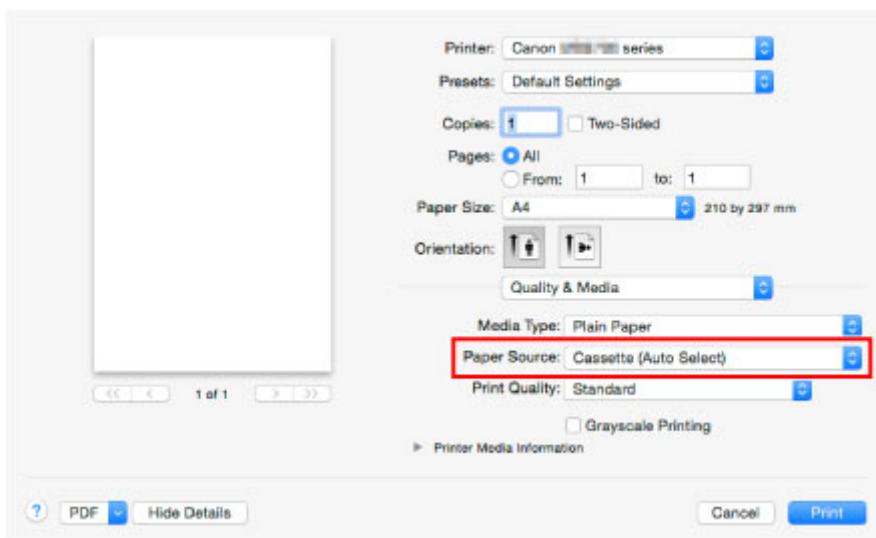

15. Once the print settings are complete, click **Print** to print.

▶▶▶ Note

- A variety of print settings can be configured with the printer driver.
 - Printing from Application Software (Mac OS Printer Driver)

Printer Functions

- ▶ **Connect Wirelessly in "Direct Connection"**
- ▶ **Download a Variety of Content Materials**
- ▶ **Print Items with Easy-PhotoPrint+ (Web Application)**
- ▶ **Managing Printer Conveniently Using Quick Utility Toolbox**
- ▶ **Available Connection Methods**
- ▶ **Using PIXMA/MAXIFY Cloud Link**
- ▶ **Print Easily from a Smartphone or Tablet with Canon PRINT Inkjet/SELPHY**
- ▶ **Printing with Windows RT**

Printing from an AirPrint-enabled Printer

- **Printing from an AirPrint-enabled Printer with Mac**
- **Printing from an AirPrint-enabled Printer with iOS Device**

Printing from an AirPrint-enabled Printer with Mac

Using AirPrint to print from your iPhone, iPad, iPod touch, or Mac.

AirPrint enables you to print photos, email, Web pages and documents from iPhone, iPad, iPod touch, and Mac without the need to install drivers, or download apps or software.

»» Note

- If you want to print using AirPrint from iOS device, see below.

■ [Printing from an AirPrint-enabled Printer with iOS Device](#)



Checking Your Environment

First, check your environment.

- **AirPrint Operation Environment**
 - iPhone, iPad, and iPod touch running the latest version of iOS
 - Mac running the latest version of Mac OS

- **Requirement**

The iOS device or Mac and the printer must be connected to the same network over a LAN or connected directly without wireless router.

Adding Printer as AirPrint Printer to Your Mac

1. Open **System Preferences**, and select **Printers & Scanners (Print & Scan)** on your Mac.
2. Select **+** to display the printer list.
3. Select the printer's name listed as **Bonjour**.
4. Select **Secure AirPrint** or **AirPrint** from **Use**.
5. Select **Add**.

Printing with AirPrint from Mac

1. [Make sure printer is turned on.](#)

▶▶▶ Note

- If the printer's Auto Power On function is enabled, the printer is turned on automatically when it receives the print data.

2. [Load paper.](#)

3. Perform printing on your application software.

Print dialog appears.

4. Select your model name added as AirPrint printer from the **Printer** list in the Print Dialog.

5. Set the paper size, media type, and other settings as needed.

6. Select **Print**.

When you execute printing, the printer prints according to the specified settings.

▶▶▶ Note

- For wireless LAN connection:
 - After you turn on the printer, it may take few minutes before the printer can communicate through a wireless LAN connection. Make sure the printer is connected to the wireless LAN and try printing.
 - If Bonjour on the printer is disabled, AirPrint cannot be used. Check the LAN settings on the printer, and enable Bonjour.
- For other AirPrint troubleshooting, see below.

■ [Cannot Print Using AirPrint](#)

Checking Print Status

- Display the Printing Status Screen

Deleting Print Job

To delete a print job with AirPrint, use one of the following two methods:

- From printer: Use **Stop** button to cancel the print job.
- From iOS device: Deleting the Undesired Print Job

Printing from an AirPrint-enabled Printer with iOS Device

Using AirPrint to print from your iPhone, iPad, iPod touch, or Mac.

AirPrint enables you to print photos, email, Web pages and documents from iPhone, iPad, iPod touch, and Mac without the need to install drivers, or download apps or software.

▶▶▶ Note

- If you want to print using AirPrint from Mac, see below.

■ [Printing from an AirPrint-enabled Printer with Mac](#)



Checking Your Environment

First, check your environment.

- **AirPrint Operation Environment**
 - iPhone, iPad, and iPod touch running the latest version of iOS
 - Mac running the latest version of Mac OS

- **Requirement**

The iOS device or Mac and the printer must be connected to the same network over a LAN or connected directly without wireless router.

Printing with AirPrint from iOS Device

1. [Make sure printer is turned on.](#)

▶▶▶ Note

- If the printer's Auto Power On function is enabled, the printer is turned on automatically when it receives the print data.

2. [Load paper.](#)
3. Tap operation icon to display menu options from applications of your iOS device.

The figure below is an example of when printing from the iPad web browser. The screen differs depending on the devices or applications.



4. Tap **Print** from menu options.



5. Select your model name from **Printer** on **Printer Options**.

➤➤➤ **Important**

- Because some applications do not support AirPrint, **Printer Options** may not be displayed. If an application does not let you use printer options, you cannot print from that application.

▶▶▶ Note

- **Printer Options** differ depending on the application that you are using.

6. When printing file type that has multiple pages, such as PDF file, tap **Range** and tap **All Pages** or select range of pages to be printed.
7. For **1 Copy**, tap **+** or **-** to set number of required copies.
8. For **Duplex Printing**, tap **On** to enable duplex printing or tap **Off** to disable function.
9. Tap **Print**.

When you execute printing, the printer prints according to the specified settings.

▶▶▶ Note

- For wireless LAN connection:
 - After you turn on the printer, it may take few minutes before the printer can communicate through a wireless LAN connection. Make sure the printer is connected to the wireless LAN and try printing.
 - If Bonjour on the printer is disabled, AirPrint cannot be used. Check the LAN settings on the printer, and enable Bonjour.
- For other AirPrint troubleshooting, see below.

■ [Cannot Print Using AirPrint](#)

Paper Size

With AirPrint, the paper size is selected automatically according to the application being used on the iOS device and the region in which AirPrint is used.

When you use the photo application, the default paper size is L size in Japan, and 4"x6" or KG in other countries and regions.

When you use the document application, the default paper size is letter size in the U.S. region, and A4 in Japan and Europe.

▶▶▶ Important

- Depending on the device or operation system, the default paper size is different from above size.
We recommend you perform test printing.
- Your application may support different paper sizes.

Printing of Envelopes

For printing on the envelope from iOS device with AirPrint, refer to the following.

Print result image	Orientation of print data	Orientation of loading envelope
--------------------	---------------------------	---------------------------------

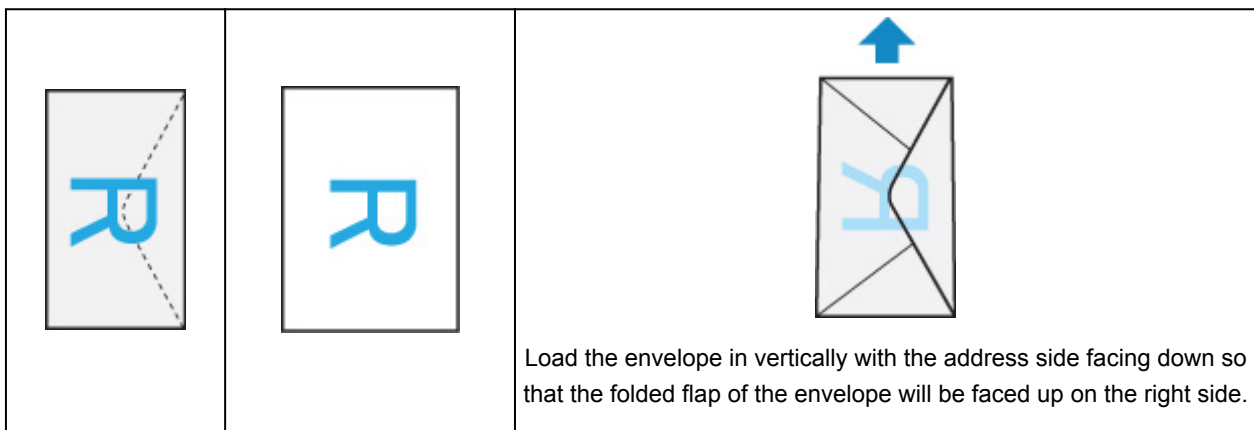

Checking Print Status

During printing, a **Print Center** icon is displayed in the list of recently used applications and you can use it to check the print progress.

Press the Home button on the iOS device twice to set the **Multitasking** mode. Then swipe to the right to display the **Print Center** icon and a **Print Summary**.

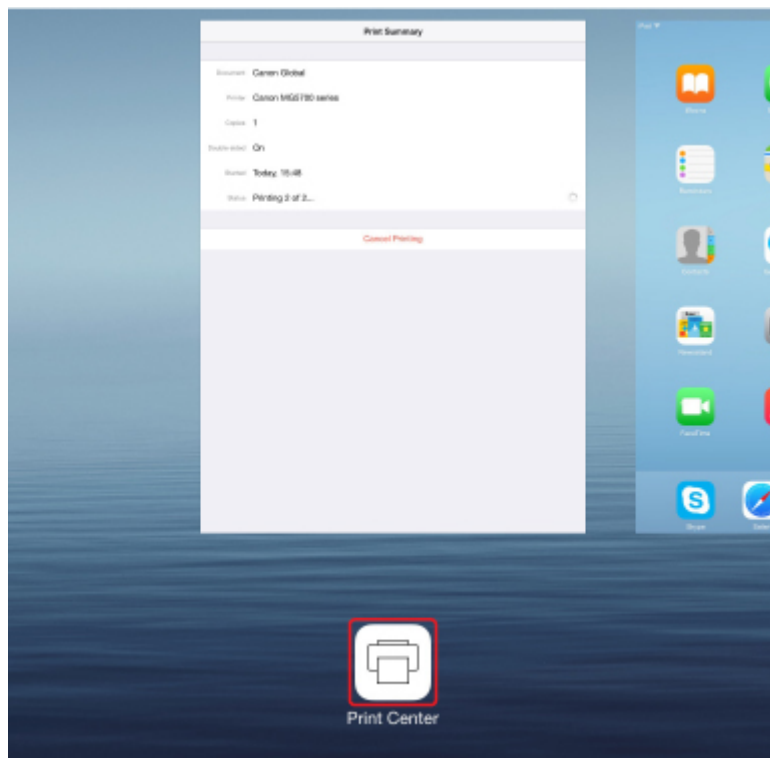

Deleting Print Job

To delete a print job with AirPrint, use one of the following two methods:

- From printer: Use **Stop** button to cancel the print job.
- From iOS device: Press the Home button on the iOS device twice to set the **Multitasking** mode and swipe to the right. Tap the **Print Center** icon to display a **Print Summary**. Tap the print job to be canceled and tap **Cancel Printing**.

Connect Wirelessly in "Direct Connection"

The printer supports "direct connection" in which you can connect to the printer wirelessly from a computer or smartphone without a wireless router.

Switch to "direct connection" to print wirelessly.

■ [Using Printer with Direct Connection](#)



Download a Variety of Content Materials

CREATIVE PARK

A "printing materials site" where you can download all the printing materials for free.

Various types of content such as seasonal cards and paper crafts that can be made by assembling paper parts are provided.

CREATIVE PARK PREMIUM

A service where customers using models that support PREMIUM Contents can download exclusive printing materials.

PREMIUM Contents can be downloaded easily via Easy-PhotoPrint+. Downloaded PREMIUM Contents can be printed directly with Easy-PhotoPrint+.

To download PREMIUM Contents, make sure that genuine Canon ink tanks/ink cartridges are installed for all colors on a supported printer.



►► Note

- The designs of PREMIUM Contents provided in this page are subject to change without prior notice.

Print Items with Easy-PhotoPrint+ (Web Application)

You can easily create and print personalized items such as calendars and collages, anytime and anywhere, by simply accessing Easy-PhotoPrint+ on the web from a computer or tablet.

By using Easy-PhotoPrint+, you can create items in the latest environment without going through the trouble of installation.

Moreover, you can use various photos for your item through integration with social networks such as Facebook, or with online storage, web albums, etc.

Refer to "Easy-PhotoPrint+ Guide" for details.



Managing Printer Conveniently Using Quick Utility Toolbox

Quick Utility Toolbox is a shortcut menu that lets you access the functions you want to use with one click. After installing utilities compatible with Quick Utility Toolbox, they will be added to this menu. The Quick Utility Toolbox provides a convenient way to quickly launch added utilities for making printer settings and doing other management tasks.

Refer to the following for details.

- Quick Utility Toolbox Guide (Windows)
- Quick Utility Toolbox Guide (Mac OS)



Available Connection Methods

The following connection methods are available on the printer.

Wireless Connection

- With a wireless router



- Without a wireless router



Wired Connection



USB Connection



Wireless Connection

There are two methods for connecting the printer to your device (e.g. smartphone or tablet). One method is to connect using a wireless router, and the other method is to connect without using a wireless router.

The two connection methods cannot be used at the same time.

If you have a wireless router, we recommend you use the method described in Connection Using a Wireless Router.

When connecting another device while a device is already connected to the printer, connect it using the same connection method as the connected device.

If you connect using a different connection method, the connection to the device in use will be disabled.

• Connection Using a Wireless Router



- Connect the printer and a device using a wireless router.
- Connection methods vary depending on the wireless router type.
- You can change network settings such as the SSID and security protocol on the printer.
- When the connection between a device and a wireless router is completed and  (Wi-Fi icon) is displayed in the device's screen, you can connect the device to the printer using the wireless router.

• Connection without Using a Wireless Router



- Connect the printer and a device without using a wireless router. Connect the device and the printer directly using the printer's direct connection.
- While you are using the printer with direct connection, Internet connection from the printer becomes unavailable. In that case, web services for the printer cannot be used.
- If you connect a device connected to the Internet via a wireless router to the printer that is in the direct connection, the connection between the device and wireless router will be disabled. In that case, the connection of the device may switch to a mobile data connection automatically depending on your device. Transmission fees for connecting to the Internet using a mobile data connection apply.
- In the direct connection, you can connect up to five devices at the same time. If you try to connect a sixth device while five devices are already connected, an error will appear. If an error appears, disconnect a device you do not use and configure settings again.
- Network settings such as the SSID and security protocol are specified automatically.

Wired Connection

Connect the printer and a hub or router with an Ethernet cable. Prepare an Ethernet cable.

USB Connection

Connect the printer and a computer with a USB cable. Prepare a USB cable.

Restrictions

(Appears in a new window)

Using PIXMA/MAXIFY Cloud Link

By using PIXMA/MAXIFY Cloud Link, you can connect your printer to a cloud service, such as CANON IMAGE GATEWAY, Evernote, or Twitter, and use the following functions without using a computer:

- Print images from a photo-sharing service
- Print documents from a data management service
- Save scanned images to a data management service.
- Use Twitter to report the printer status, such as no paper or low ink levels.

In addition, you can use various functions by adding and registering apps that are linked with various cloud services.

■ Using PIXMA/MAXIFY Cloud Link from Your Printer

■ [Using PIXMA/MAXIFY Cloud Link from Your Smartphone, Tablet, or Computer](#)



▶▶▶ Important

- In certain countries, PIXMA/MAXIFY Cloud Link may not be available or the available apps may be different.
- Some apps require that you have an account before you use those apps. For such apps, please set up an account beforehand.
- To find out which models support PIXMA/MAXIFY Cloud Link check the Canon homepage.
- The screen display may change without prior notice.

Notice for Web Service Printing

When Using Web Service

- Canon does not guarantee the continuity and reliability of the web services provided, the availability of site access, or permission to download the materials.
- Canon may at any time update, change, or delete the information provided through the web service, or may suspend or discontinue the service without prior notice. Canon shall not be held responsible for any damages resulting from such actions.
- In no event shall Canon be liable for any damages whatsoever resulting from the use of the web services.
- User registration is necessary before you can use the external link site.
When you use the external link site, observe the conditions of use of the site and use the service within your own responsibility.
- All or part of the web service may not be available depending on the country or region you live in.
- Depending on your network environment, some functions on web service are not available. Even if they are available, it may take a while to print or display the contents, or communication may be interrupted while operation is in progress.
- When you use web service, your machine's name, information of your region or country, your selected language, and what kind of service you use (e.g. photo sharing site) are sent to and saved in our server. Canon is unable to identify specific customers using this information.
- Before you transfer ownership or dispose of a printer that supports a color LCD monitor, select **Device settings** -> **Reset setting** -> **Reset all** and delete your login name and password.
- For details, contact a Canon-authorized sales representative in the country or region you live in.

To Those Living in Mainland China

- PIXMA/MAXIFY Cloud Link, Easy-PhotoPrint+, and some functions of Canon PRINT Inkjet/SELPHY, which are included with this machine, are provided by Canon Inc.
However, as the server is installed outside of mainland China, some of these services may not be available yet.

Copyrights and Rights of Publicity

When printing using a service provided by Canon

1. The copyright of each material (photos, illustrations, logos, or documents: hereinafter referred to as "the materials") provided on the printing service belongs to their respective owners. Issues pertaining to Rights of Publicity may arise regarding the use of any of people or characters displayed on the printing service.

Except as otherwise permitted (please see "2" below), copying, modifying or distributing all or a portion of any of the materials contained on the web template printing service without prior consent of the respective rights (Rights of Publicity and Copyright) holder is strictly prohibited.
2. All of the materials provided on the web template printing service can be freely used for personal and non-commercial purposes.

Using PIXMA/MAXIFY Cloud Link from Your Smartphone, Tablet, or Computer

- ▶ **Before Using Canon Inkjet Cloud Printing Center**
- ▶ **Registering User Information to Canon Inkjet Cloud Printing Center**
- ▶ **Using Canon Inkjet Cloud Printing Center**
- ▶ **Adding a Printer**
- ▶ **Adding a PIXMA/MAXIFY Cloud Link User**
- ▶ **Troubleshooting Canon Inkjet Cloud Printing Center**

Before Using Canon Inkjet Cloud Printing Center

Canon Inkjet Cloud Printing Center is a service that links with the cloud function of the printer and allows you to perform operations such as registering and managing apps from your smartphone or tablet device, and checking the print status, print error, and ink status of the printer. You can also print app photos and documents from your smartphone or tablet.

First, check the following content:

- **Precautions**

If you plan to use the web service to print documents, be sure to check these [precautions](#) beforehand.

- **Printer specification**

Check that Canon Inkjet Cloud Printing Center supports the printer.

Some models do not support this function. To check whether your model supports this function, see "Models that Support Canon Inkjet Cloud Printing Center".

- **Network environment**

The printer must be connected to a LAN and to the Internet.

▶▶▶ Important

- The user will bear the cost of Internet access.

- **Operating requirements**

For computers, smartphones, and tablet devices, see "[Requirements for Canon Inkjet Cloud Printing Center operation](#)".

▶▶▶ Important

- This service may not be available in certain countries or regions. Also even if the service is available, there are apps that cannot be used in certain regions.

■ [Registering User Information to Canon Inkjet Cloud Printing Center](#)

Requirements for Canon Inkjet Cloud Printing Center operation

Computer

CPU	x86 or x64 1.6 GHz or higher
RAM	2 GB or higher
Monitor display	Resolution 1024 x 768 pixels or higher Number of display colors 24 bits (true-color) or higher

OS	Browser
Windows Vista SP2	Internet Explorer 9 Mozilla Firefox Google Chrome
Windows 7	Internet Explorer 9, 10, 11 Mozilla Firefox Google Chrome
Windows 8	Internet Explorer 10, 11 Mozilla Firefox Google Chrome
Windows 8.1	Internet Explorer 11 Mozilla Firefox Google Chrome
Windows 10	Internet Explorer 11 Microsoft Edge Mozilla Firefox Google Chrome
Mac OS X v10.6-OS X Yosemite v10.10	Safari 5.1, 6, 7, 8

Smartphone or tablet

OS	Browser	Resolution
iOS 7 or later	OS standard browser	320 x 480 or higher
Android 4 or later		480 x 800 or higher

The operation requirements may change without prior notice. If this happens, you may no longer be able to use this service from your computer, smartphone, or tablet.

»»» Important

- On the browser you are using, enable JavaScript and cookies.
- If you use the zoom function or change the font size on your browser, the web pages may not display correctly.
- If you use the translation function of Google Chrome, the web pages may not display correctly.
- The service does not support the use of its provided services through a proxy server outside of your country.

- In an in-house network environment, the 5222 port must be released. For confirmation instructions, contact the network administrator.
-

Registering User Information to Canon Inkjet Cloud Printing Center

To use the Canon Inkjet Cloud Printing Center, you need to follow the steps described below and register **My account** information.

- [If your model has color LCD monitor](#)
- [If your model has monochrome LCD monitor](#)
- [If your model has no LCD monitor/If you are using PRO-1000 series or PRO-500 series](#)

Registering User Information to Canon Inkjet Cloud Printing Center (Color LCD Monitor)

To use the Canon Inkjet Cloud Printing Center, you need to follow the steps described below and register **My account** information.

Registering from Printer

1. Check that the printer is connected to the Internet

2. From the printer home screen, select  **Cloud**

If printer information has not been registered to the cloud service server, the Registration Preparation Completion Screen appears.

3. From cloud main screen, select **Use from Smartphone** or **Mobile Integration Guide**

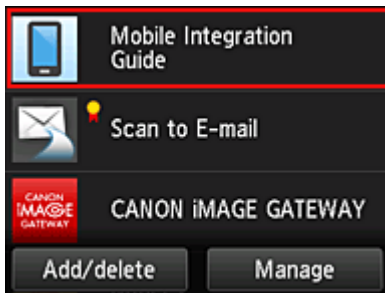

4. Follow instructions appearing in screen, and select **Next**
5. In user registration screen, select **Show QR Code**

You can also access the URL manually from you smartphone, tablet, or computer.

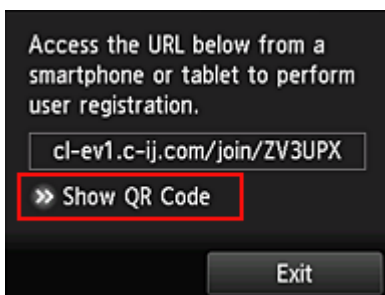

6. Read displayed QR code by using your smartphone or tablet



To return to the cloud main screen, select **Exit**.

➤➤➤ Note

- You must have a special app to read QR codes from your smartphone or tablet. If you do not have an app that reads QR codes on your smartphone or tablet, install one from App Store or Google Play.

7. In **Preparation for registration** screen, select **Send blank e-mail**

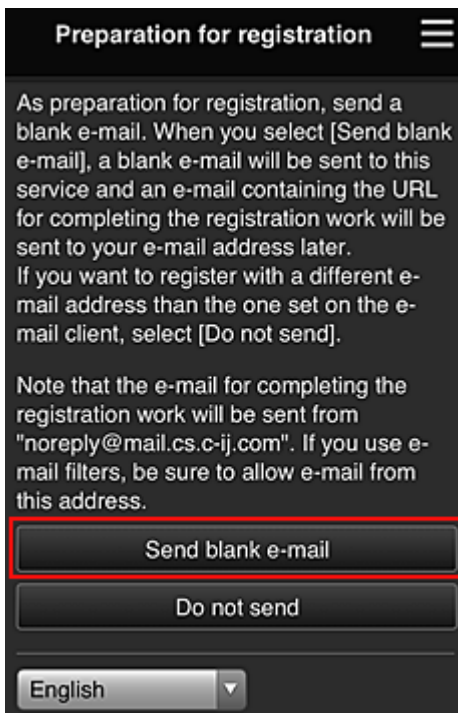

➤➤➤ Note

- When you select **Send blank e-mail**, the "destination entry completed" mailer starts up automatically.
After the blank e-mail is created, send that e-mail without making any changes.

If you want to register a different e-mail address, select **Do not send** to display the **E-mail address** entry screen.

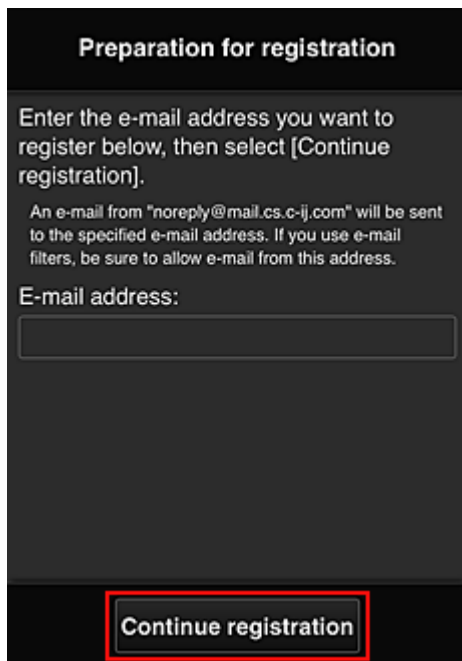

In the displayed screen, enter the **E-mail address** that you want to register, and then select **Continue registration**.

➤➤ Note

- If you enter an e-mail address that has already been registered, you will receive an "already registered" e-mail. Follow the instructions in the e-mail, and register a different e-mail address.

➤➤ Important

- There are character restrictions for the e-mail address, as shown below.
 - Up to 255 characters consisting of single-byte alphanumeric characters and symbols (!\$*/^_{}~.-@). (Uppercase and lowercase letters are differentiated.)
 - Multibyte characters cannot be used.
You will get an error if the e-mail address you enter contains a character that cannot be used.
- If you registered a different e-mail address by mistake, you can cancel the registration by going to the printer's Home screen and selecting **Setup** -> **Web service setup** -> **Web service connection setup** -> **IJ Cloud Printing Center setup** -> **Delete from this service**.
- You may not be able to receive the notification if you are using a spam filter. If you have a setting to receive only the e-mails from certain domains, be sure to change the setting to allow receiving e-mails from "noreply@mail.cs.c-ij.com".
There will be no error display even if you could not receive the e-mail because of the spam filter setting or if you entered an incorrect e-mail address.

8. Check that you received blank e-mail, and then select **Yes**

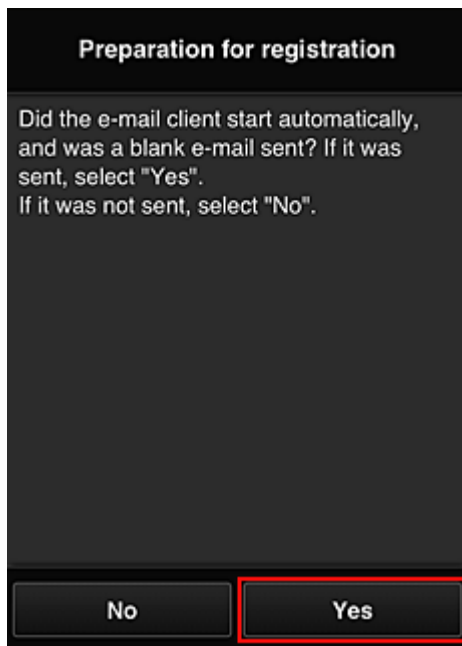

9. Follow instructions in screen display, and select **OK**

The registration page URL will be sent to the registered e-mail address.

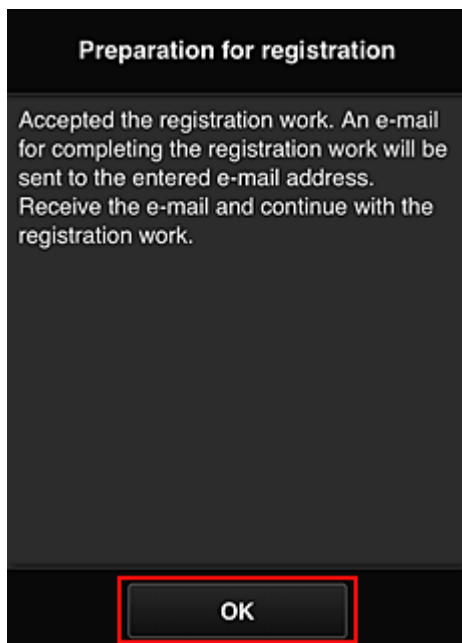

Access the URL in the e-mail, Register the Information, and Complete the User Registration

1. Check that e-mail containing URL has been sent to registered e-mail address, and access URL
2. In the **License agreement** and **Privacy statement** windows of Canon Inkjet Cloud Printing Center, read the statements, and select **Agree** if you agree

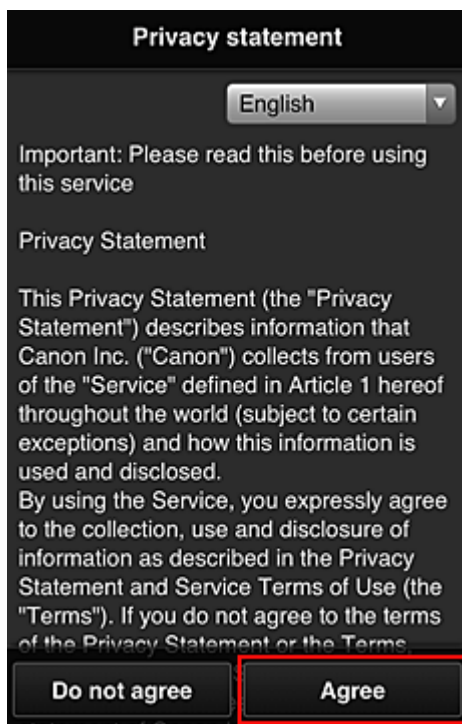
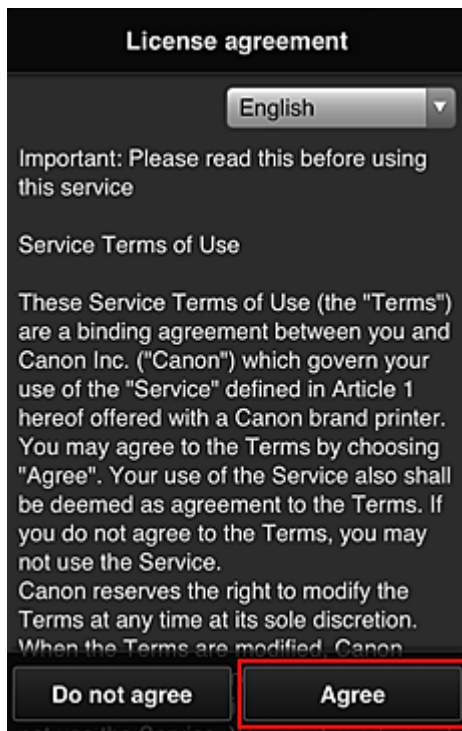

3. Register password for logging in to Canon Inkjet Cloud Printing Center

In the My account registration screen, enter the password you want to register into **Password** and **Password (Confirmation)**, and then select **Next**.

Register My account

Set a password for logging into this service.

Password:

Password (Confirmation):

8 to 32 characters

Cancel Next

»» Important

- There are character restrictions for the **Password**, as shown below.
- The password must be between 8 and 32 characters long, using single-byte alphanumeric characters and symbols (!"#\$\$%&'()*+,-./:;<=>?@[¥]^_`{|}~). (Alphabets are case-sensitive)

4. Enter **Nickname**

Enter any user name you want to use.

Register My account

Nickname:

1 to 20 characters

Time zone:

(UTC) Coordinated Universal Time ▼

Back Done

»» Important

- The user name entry field has the following character restrictions:

- The user name must be between 1 and 20 characters long, using single-byte alphanumeric characters and symbols (!"#\$%&'()*+,-./:;<=>@[¥]^_`{|}~). (Alphabets are case-sensitive)

5. Specify the **Time zone** setting, and select **Done**

Select your region on the list. If you cannot find your region on the list, select the one closest to your region.

Apply daylight saving time

This appears only when there is a daylight saving time in the **Time zone** that you selected. Select whether or not to apply the daylight saving time.

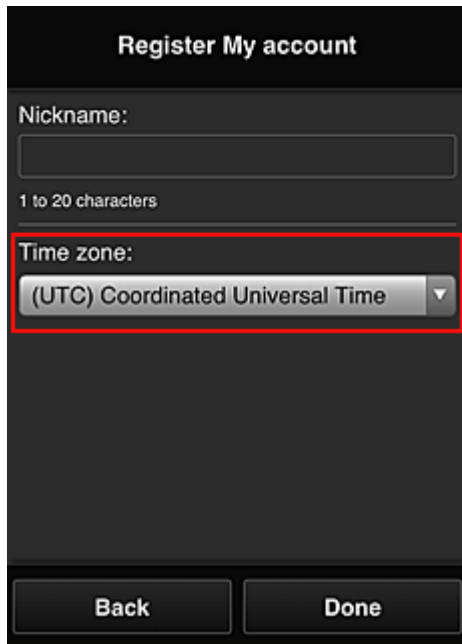

The screenshot shows a registration form titled "Register My account". It includes a "Nickname:" field with a "1 to 20 characters" constraint. Below this is a "Time zone:" dropdown menu, which is highlighted with a red border and currently displays "(UTC) Coordinated Universal Time". At the bottom of the form are two buttons: "Back" and "Done".

The registration is complete. A registration completion message is displayed. When you select the **OK** button in the message, the login screen is displayed.

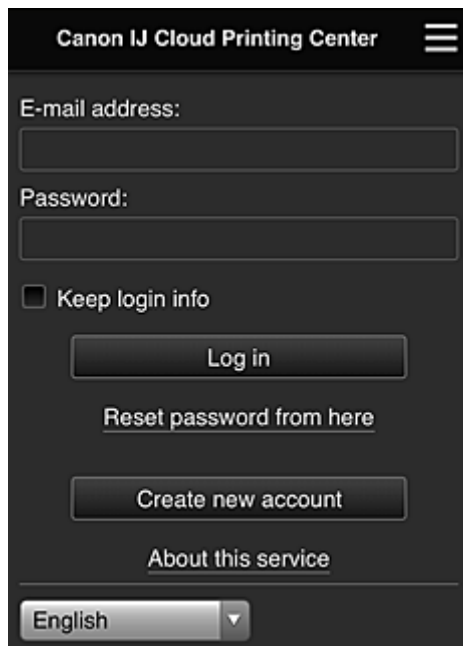

The screenshot shows the login screen for "Canon IJ Cloud Printing Center". It features an "E-mail address:" field, a "Password:" field, and a "Keep login info" checkbox. Below these are buttons for "Log in", "Reset password from here", "Create new account", and "About this service". At the bottom, there is a language dropdown menu currently set to "English".

Enter the registered **E-mail address** and **Password**, and [Log in](#) to the Canon Inkjet Cloud Printing Center.

■ [Using Canon Inkjet Cloud Printing Center](#)

Registering User Information to Canon Inkjet Cloud Printing Center (Monochrome LCD Monitor)

To use the Canon Inkjet Cloud Printing Center, you need to follow the steps described below and register **My account** information.

Print registration information from the printer

1. On the printer operation panel, select the  **Setup** button, and then select **Web service setup** -> **Connection setup** -> **IJCloudPrintingCtr** -> **Register w/ service**

2. In the registration confirmation window, Select **Yes**

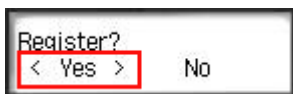

3. In the print settings, select the display language

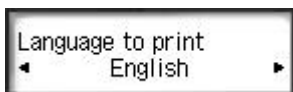

4. Follow the instructions displayed in the window, and print the URL of the authentication site and the [Printer registration ID](#)

Set A4 size or Letter size or Legal size plain paper and select **OK**.

The authentication URL and **Printer registration ID** are printed.

▶▶▶ Important

- The operation to complete the registration should be done within 60 minutes.

Access the URL on the printed page, and then enter the e-mail address and other necessary information

▶▶▶ Important

- Do not use the Back button of the web browser while an operation is processing. The screen may not transition properly.

▶▶▶ Note

- If you enter an e-mail address that has already been registered, you will receive an "already registered" e-mail. Follow the instructions in the e-mail, and register a different e-mail address.

1. Use the web browser on your PC, smartphone, tablet, or other devices to access the authentication URL



2. When the printer registration screen is displayed, select **Create new account**

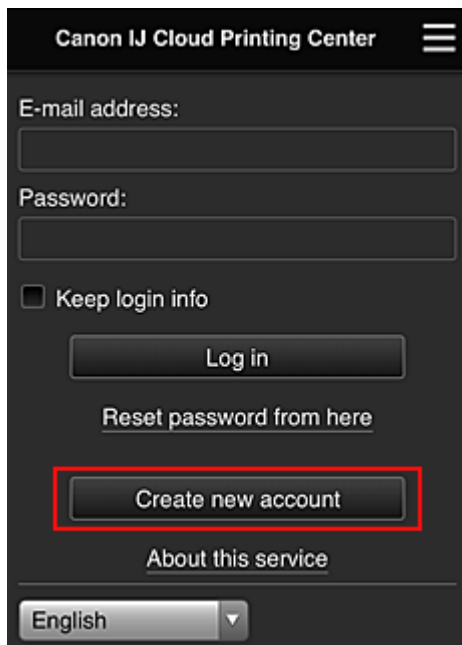

3. Enter the **E-mail address** and **Printer registration ID** of the printer's owner, and then select **OK**

The registration page URL is sent to the e-mail address entered.

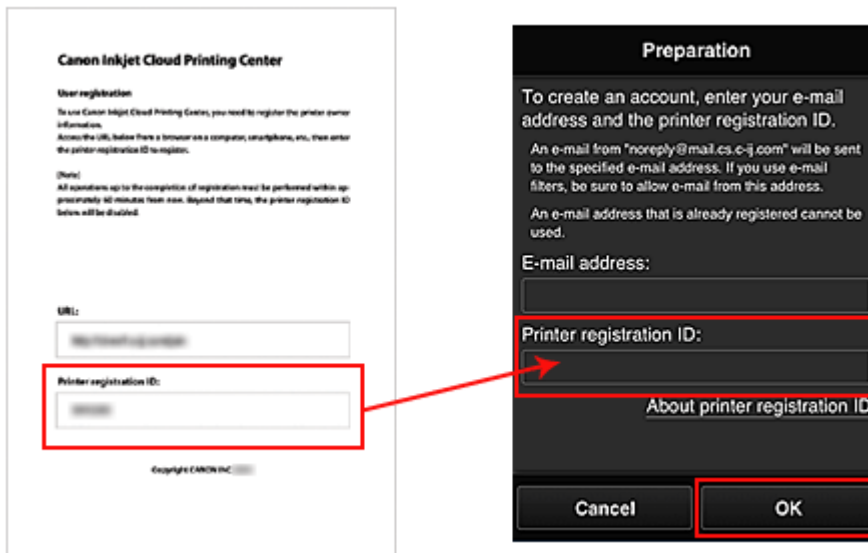

Important

- There are character restrictions for the e-mail address, as shown below.
 - Up to 255 characters consisting of single-byte alphanumeric characters and symbols (!\$*/^_{}|~.-@). (Uppercase and lowercase letters are differentiated.)
 - Multibyte characters cannot be used.
You will get an error if the e-mail address you enter contains a character that cannot be used.
- If you registered a different e-mail address by mistake, you can cancel the registration by selecting the **Setup** button on the printer operation panel, and then selecting **Web service setup** -> **Connection setup** -> **IJCloudPrintingCtr** -> **Delete from service**.
- You may not be able to receive the notification if you are using a spam filter. If you have a setting to receive only the e-mails from certain domains, be sure to change the setting to allow receiving e-mails from "noreply@mail.cs.c-ij.com".
There will be no error display even if you could not receive the e-mail because of the spam filter setting or if you entered an incorrect e-mail address.

Access the URL in the e-mail, Register the Information, and Complete the User Registration

1. Check that e-mail containing URL has been sent to entered e-mail address, and access URL
2. In the **License agreement** and **Privacy statement** windows of Canon Inkjet Cloud Printing Center, read the statements, and select **Agree** if you agree

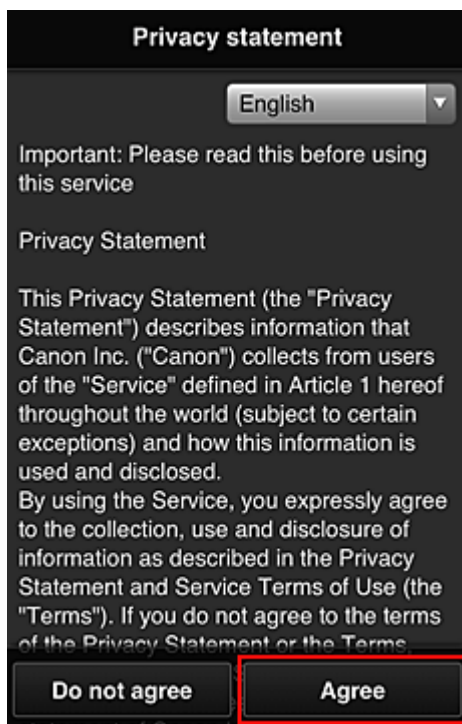
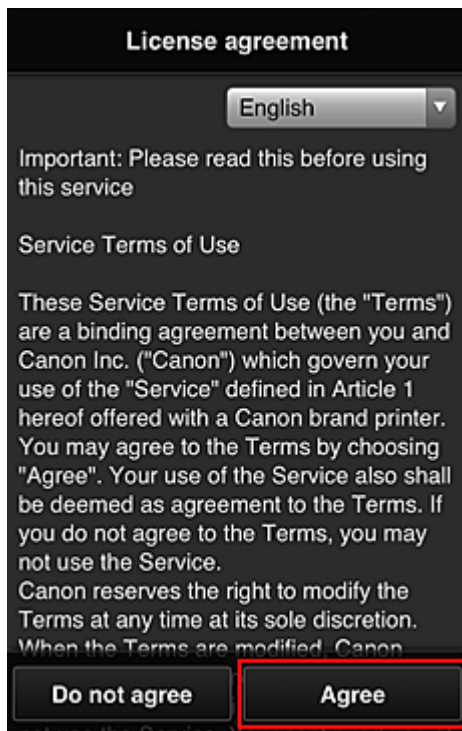

3. Register password for logging in to Canon Inkjet Cloud Printing Center

In the My account registration screen, enter the password you want to register into **Password** and **Password (Confirmation)**, and then select **Next**.

The screenshot shows a dark-themed mobile interface titled "Register My account". Below the title, it says "Set a password for logging into this service." There are two text input fields: "Password:" and "Password (Confirmation):". Below the second field, it says "8 to 32 characters". At the bottom, there are two buttons: "Cancel" and "Next". The "Next" button is highlighted with a red border.

»» Important

- There are character restrictions for the **Password**, as shown below.
- The password must be between 8 and 32 characters long, using single-byte alphanumeric characters and symbols (!"#\$%&'()*+,-./:;<=>@[¥]^_`{|}~). (Alphabets are case-sensitive)

4. Enter **Nickname**

Enter any user name you want to use.

The screenshot shows the same "Register My account" screen. The "Nickname:" field is now the focus, with a red border around it. Below the field, it says "1 to 20 characters". Below that is a "Time zone:" label and a dropdown menu currently showing "(UTC) Coordinated Universal Time". At the bottom, there are two buttons: "Back" and "Done".

»» Important

- The user name entry field has the following character restrictions:

- The user name must be between 1 and 20 characters long, using single-byte alphanumeric characters and symbols (!"#\$%&'()*+,-./:;<=>@[¥]^_`{|}~). (Alphabets are case-sensitive)

5. Specify the **Time zone** setting, and select **Done**

Select your region on the list. If you cannot find your region on the list, select the one closest to your region.

Apply daylight saving time

This appears only when there is a daylight saving time in the **Time zone** that you selected. Select whether or not to apply the daylight saving time.

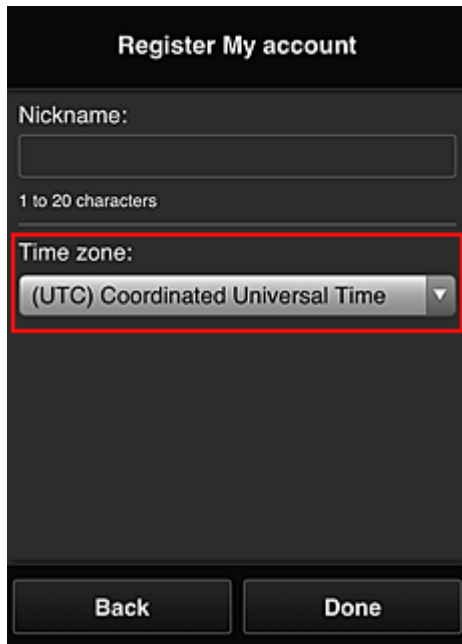

The screenshot shows a registration form titled "Register My account". It includes a "Nickname:" field with a "1 to 20 characters" constraint. Below this is a "Time zone:" dropdown menu, which is highlighted with a red border and currently displays "(UTC) Coordinated Universal Time". At the bottom of the form are two buttons: "Back" and "Done".

The registration is complete. A registration completion message is displayed. When you select the **OK** button in the message, the login screen is displayed.

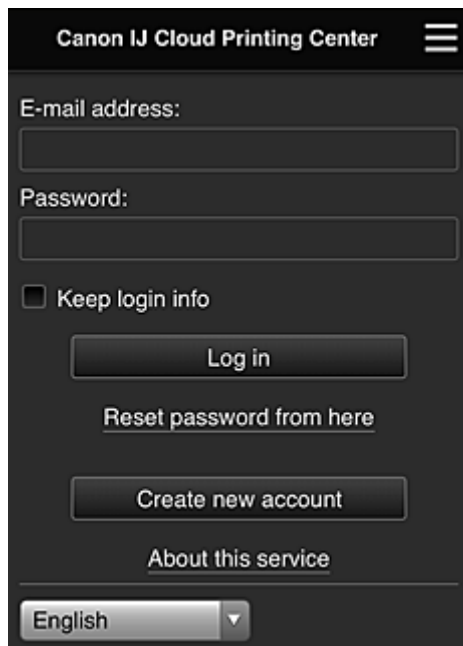

The screenshot shows the login screen for "Canon IJ Cloud Printing Center". It features an "E-mail address:" field, a "Password:" field, and a "Keep login info" checkbox. Below these are buttons for "Log in", "Reset password from here", "Create new account", and "About this service". At the bottom, there is a language selection dropdown menu currently set to "English".

Enter the registered **E-mail address** and **Password**, and [Log in](#) to the Canon Inkjet Cloud Printing Center.

■ [Using Canon Inkjet Cloud Printing Center](#)

Printing Your Printer Registration ID

▶▶▶ Important

- Some models do not support this function.

To add a printer by using Canon Inkjet Cloud Printing Center, you will need a **Printer registration ID**.



From the operation panel of this printer, print the URL of the authentication site and your **Printer registration ID**. The procedure is as follows:

1. Check that the printer is connected to the Internet

▶▶▶ Important

- To use this function, you must connect this printer to the Internet.

If your model has color LCD monitor

2. From the home window, select  **Setup** ( Various settings) ->  **Web service setup** -> **Web service connection setup** -> **IJ Cloud Printing Center setup** -> **Register with this service**

3. In the registration confirmation window, Select **Yes**

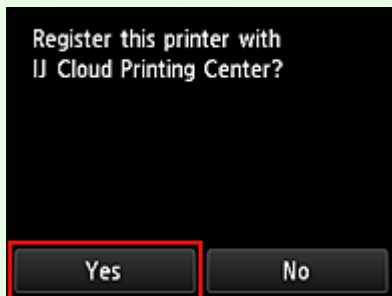

4. In the print settings, select the display language



If your model has monochrome LCD monitor

2. On the printer operation panel, select the  **Setup** button, and then select **Web service setup -> Connection setup -> IJCloudPrintingCtr -> Register w/ service**

3. In the registration confirmation window, Select **Yes**

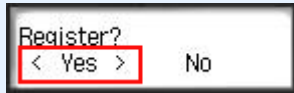

4. In the print settings, select the display language



5. Follow the instructions displayed in the window, and print the URL of the authentication site and your **Printer registration ID**

When you set A4 size or Letter size or Legal size plain paper and select **OK**, the authentication site URL and your **Printer registration ID** are printed.

Important

- The operation to complete the registration should be done within 60 minutes.

Registering User Information to Canon Inkjet Cloud Printing Center (No LCD Monitor/Using PRO-1000 series or PRO-500 series)

To use the Canon Inkjet Cloud Printing Center, you need to follow the steps described below and register **My account** information.

Registering from Your Smartphone, Tablet, or Computer

1. Check that the printer is connected to the Internet

▶▶▶ Important

- To use this function, you must connect this printer to the Internet.

2. Displaying Printer Information

For details, go to the Online Manual home page, and see "Checking Printer Information" for your model.

3. Select **IJ Cloud Printing Center setup -> Register with this service**

4. Follow the instructions displayed in the window, and run the authentication

5. When the **Preparation for registration** screen appears, select **Send blank e-mail**

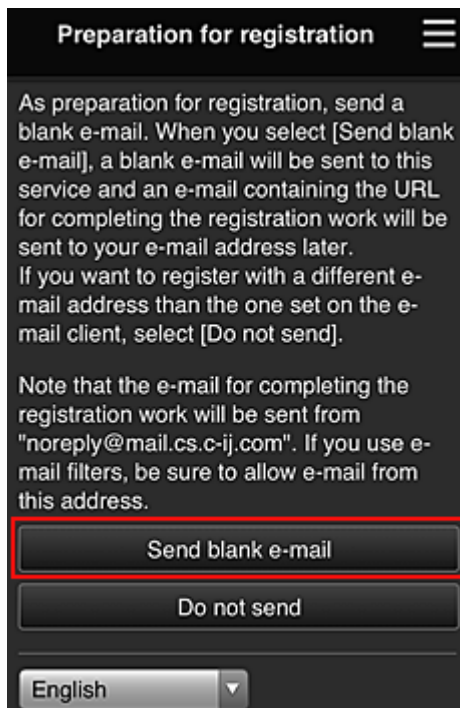

▶▶▶ Note

- When you select **Send blank e-mail**, the "destination entry completed" mailer starts up automatically.
After the blank e-mail is created, send that e-mail without making any changes.

If you want to register a different e-mail address, select **Do not send** to display the **E-mail address** entry screen.

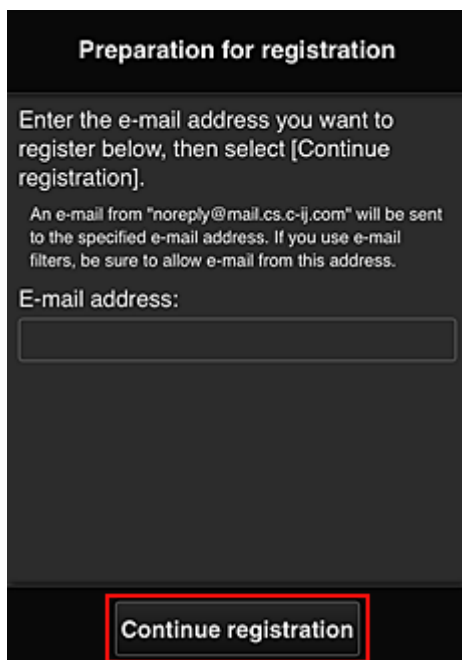

Preparation for registration

Enter the e-mail address you want to register below, then select [Continue registration].

An e-mail from "noreply@mail.cs.c-ij.com" will be sent to the specified e-mail address. If you use e-mail filters, be sure to allow e-mail from this address.

E-mail address:

Continue registration

In the displayed screen, enter the **E-mail address** that you want to register, and then select **Continue registration**.

▶▶▶ Note

- If you enter an e-mail address that has already been registered, you will receive an "already registered" e-mail. Follow the instructions in the e-mail, and register a different e-mail address.

▶▶▶ Important

- There are character restrictions for the e-mail address, as shown below.
 - Up to 255 characters consisting of single-byte alphanumeric characters and symbols (!\$*/^_{}|~.-@). (Uppercase and lowercase letters are differentiated.)
 - Multibyte characters cannot be used.
You will get an error if the e-mail address you enter contains a character that cannot be used.
- If you registered a different e-mail address by mistake, you can cancel the registration by Displaying Printer Information and selecting **IJ Cloud Printing Center setup -> Delete from this service**.
To display printer information, go to the Online Manual home page, and see "Checking Printer Information" for your model.
- You may not be able to receive the notification if you are using a spam filter. If you have a setting to receive only the e-mails from certain domains, be sure to change the setting to allow receiving e-mails from "noreply@mail.cs.c-ij.com".
There will be no error display even if you could not receive the e-mail because of the spam filter setting or if you entered an incorrect e-mail address.

6. Check that you received blank e-mail, and then select **Yes**

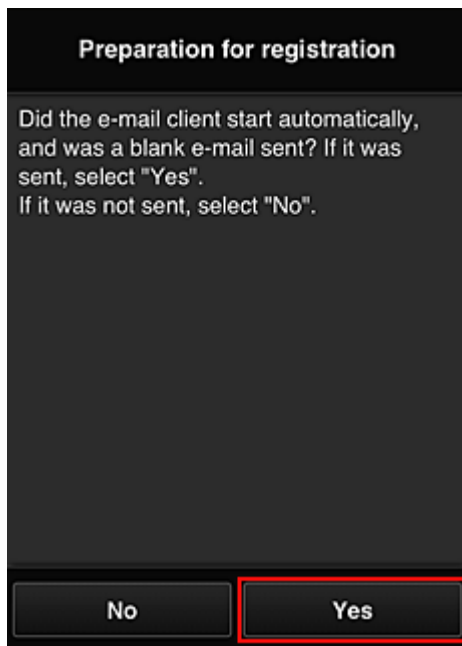

7. Follow instructions in screen display, and select **OK**

The registration page URL will be sent to the registered e-mail address.

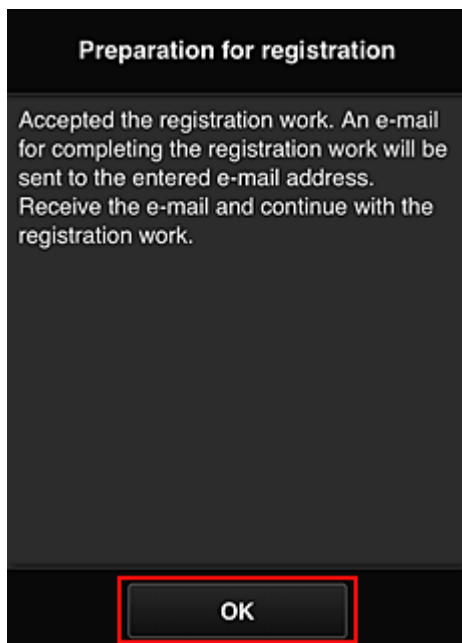

Access the URL in the e-mail, Register the Information, and Complete the User Registration

1. Check that e-mail containing URL has been sent to registered e-mail address, and access URL
2. In the **License agreement** and **Privacy statement** windows of Canon Inkjet Cloud Printing Center, read the statements, and select **Agree** if you agree

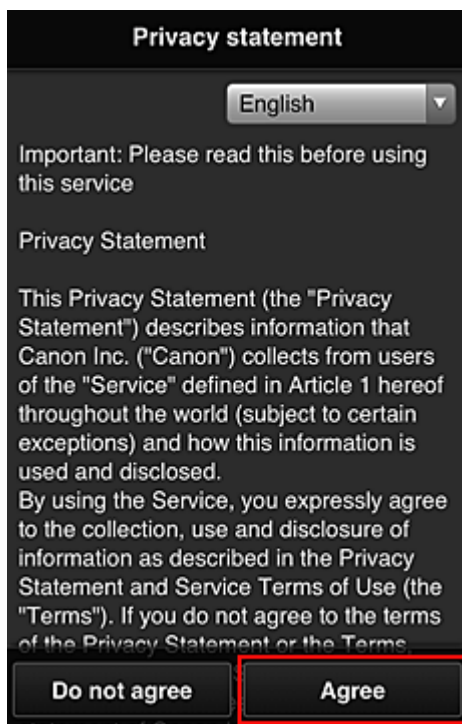
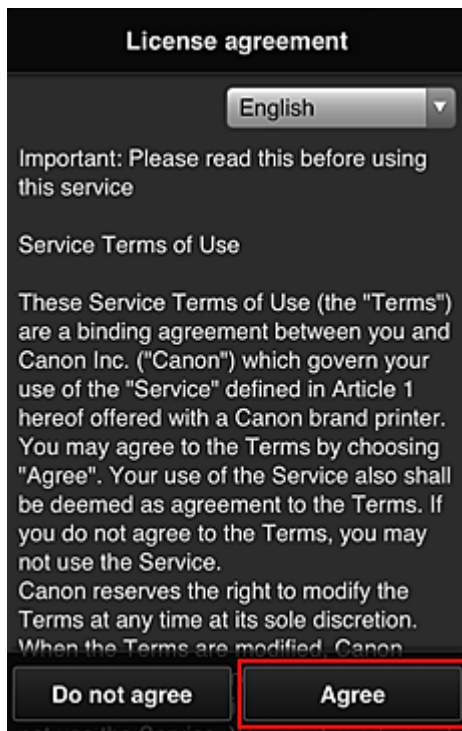

3. Register password for logging in to Canon Inkjet Cloud Printing Center

In the My account registration screen, enter the password you want to register into **Password** and **Password (Confirmation)**, and then select **Next**.

The screenshot shows a dark-themed registration screen titled "Register My account". Below the title, it says "Set a password for logging into this service." There are two text input fields: "Password:" and "Password (Confirmation):". Below the second field, it says "8 to 32 characters". At the bottom, there are two buttons: "Cancel" and "Next". The "Next" button is highlighted with a red border.

➤➤➤ Important

- There are character restrictions for the **Password**, as shown below.
- The password must be between 8 and 32 characters long, using single-byte alphanumeric characters and symbols (!"#\$\$%&'()*+,-./:;<=>?@[¥]^_`{|}~). (Alphabets are case-sensitive)

4. Enter **Nickname**

Enter any user name you want to use.

The screenshot shows the same "Register My account" screen. The "Nickname:" field is now the focus, with a red border around it. Below the field, it says "1 to 20 characters". Below the nickname field is a "Time zone:" dropdown menu with "(UTC) Coordinated Universal Time" selected. At the bottom, there are two buttons: "Back" and "Done".

➤➤➤ Important

- The user name entry field has the following character restrictions:

- The user name must be between 1 and 20 characters long, using single-byte alphanumeric characters and symbols (!"#\$%&'()*+,-./:;<=>@[¥]^_`{|}~). (Alphabets are case-sensitive)

5. Specify the **Time zone** setting, and select **Done**

Select your region on the list. If you cannot find your region on the list, select the one closest to your region.

Apply daylight saving time

This appears only when there is a daylight saving time in the **Time zone** that you selected. Select whether or not to apply the daylight saving time.

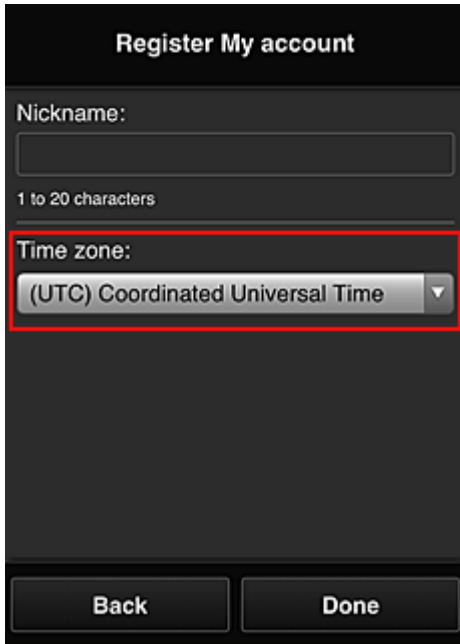

The screenshot shows a registration form titled "Register My account". It includes a "Nickname:" field with a "1 to 20 characters" constraint. Below this is a "Time zone:" dropdown menu, which is highlighted with a red border and currently displays "(UTC) Coordinated Universal Time". At the bottom of the form are two buttons: "Back" and "Done".

The registration is complete. A registration completion message is displayed. When you select the **OK** button in the message, the login screen is displayed.

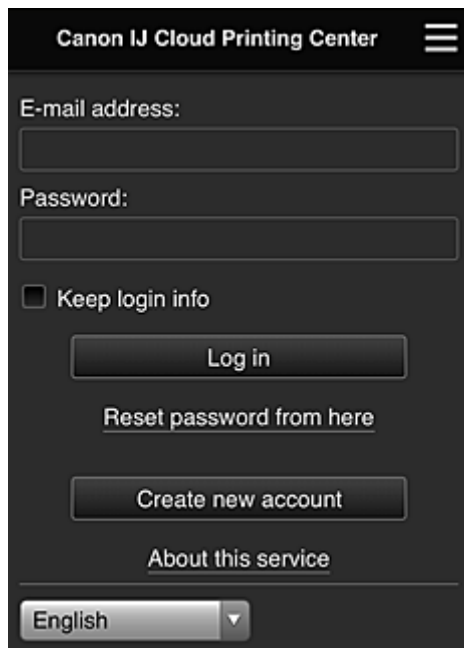

The screenshot shows the login interface for "Canon IJ Cloud Printing Center". It includes an "E-mail address:" field, a "Password:" field, and a "Keep login info" checkbox. Below these are buttons for "Log in", "Reset password from here", "Create new account", and "About this service". At the bottom, there is a language selection dropdown menu currently set to "English".

Enter the registered **E-mail address** and **Password**, and [Log in](#) to the Canon Inkjet Cloud Printing Center.

■ [Using Canon Inkjet Cloud Printing Center](#)

Using Canon Inkjet Cloud Printing Center

When the user registration is completed, you can log in to the Canon Inkjet Cloud Printing Center and use the service.

1. From your PC, smartphone, or tablet, access the service login URL (<http://cs.c-ij.com/>)
2. On the Login screen, enter the **E-mail address** and **Password**, and then select **Log in**

»» Important

- The e-mail address and password are case-sensitive. Make sure the case is correct.

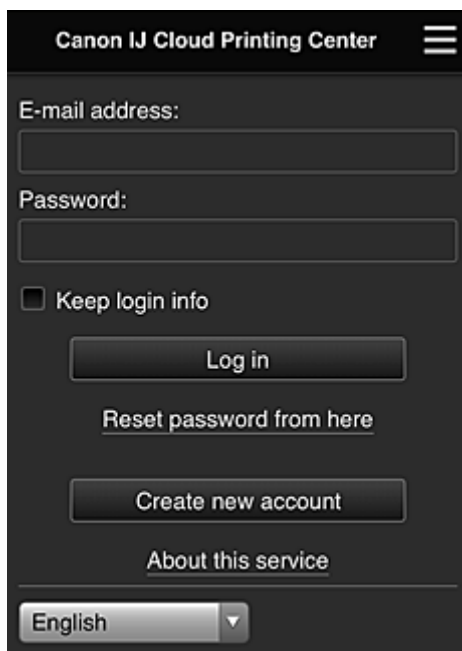

E-mail address

Enter the e-mail address that you entered in the user registration.

Password

Enter the password that you entered in the user registration.

Keep login info

When you select the check box, the login screen is skipped for 14 days since the last day that the service screen was accessed.

»» Important

- If you fail to log in five straight times, you will not be able to login again for about the next 60 minutes.
- You remain logged in for 60 minutes after the last access.
- The service may not function properly if you log in by using the same e-mail address from multiple devices at the same time.

After logging in, you can use useful services such as adding/managing apps that work in conjunction with this product's cloud functionality and checking the ink status.

For screen descriptions and operation instructions, see "[Canon Inkjet Cloud Printing Center window](#)".

Printing procedure

This section introduces the photo printing procedure by using CANON iIMAGE GATEWAY as an example.

▶▶▶ Important

- The available functions differ depending on the app.
- The printing procedure differs depending on the app.
- You need to get the account and register photo and other data beforehand.
- The following file formats can be printed: jpg, jpeg, pdf, docx, doc, xlsx, xls, pptx, ppt, and rtf.
The file formats that can be printed differ depending on the app.
- Before you print, check that printer is on and is connected to the network. Then start.
- This is available if you are using a smartphone or tablet.

▶▶▶ Note

- You can use CANON iIMAGE GATEWAY to print jpg and jpeg file formats.

1. On the Main screen, select the app to be used
2. Enter the information according to the instructions on the authentication screen, and then select **Log in**

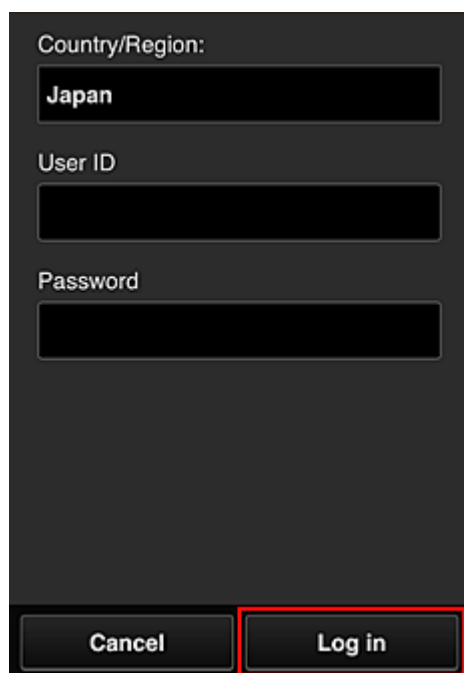

Country/Region:
Japan

User ID

Password

Cancel Log in

3. In the displayed album list, select the album of your choice

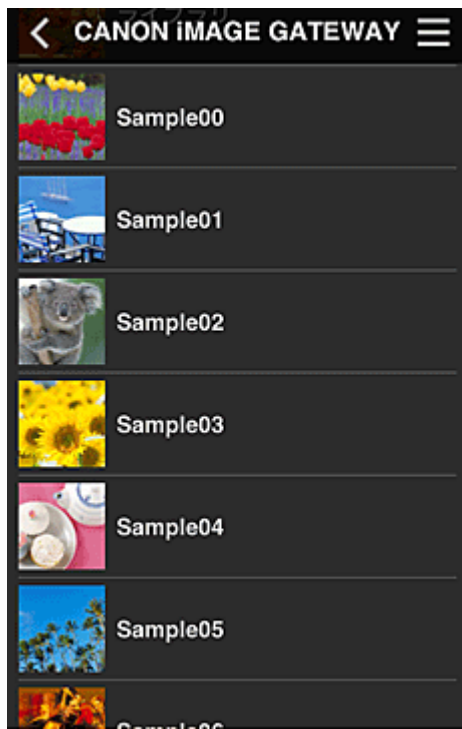

4. In the displayed image list, select the image that you want to print, and then select **Next**



5. Make the necessary print settings, and then select **Print**

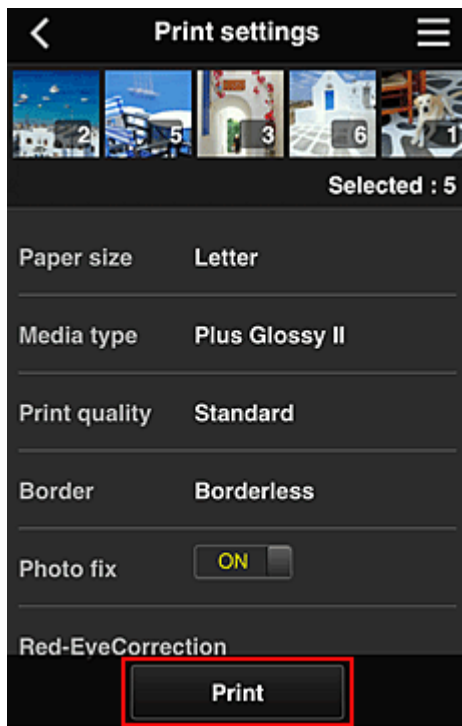

6. A print job completion message appears, and printing starts

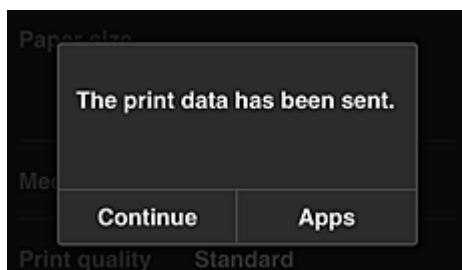

To continue printing, select **Continue**, and perform the operation from Step 3.

To end the printing, select **Apps**. The screen returns to the apps list screen.

»» Important

- If a print job is not printed within 24 hours after the print job is issued, the print job will expire and cannot be printed.
- With premium apps that limit the number of print jobs, print jobs that expire and cannot be printed are also included in the print count.

■ [Adding a Printer](#)

Canon Inkjet Cloud Printing Center window

This section describes the Canon Inkjet Cloud Printing Center screens that are displayed on your smartphone, tablet device, or computer.

■ [Description of the Login screen](#)

■ [Description of the Main screen](#)

Description of the Login screen

This section provides the description of the Login screen of Canon Inkjet Cloud Printing Center.

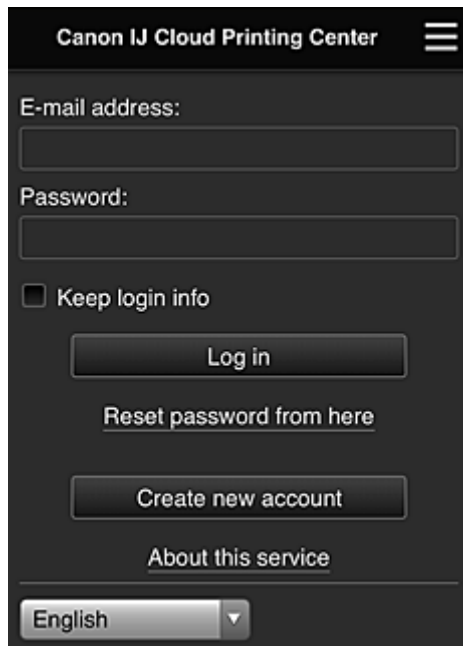

»»» Important

- You have 5 tries to enter your password. If you fail, you will not be able to log in for about the next 60 minutes.
- You remain logged in for 60 minutes after the last access.

Language

Select the language you will be using.

E-mail address

Enter the e-mail address that you entered in the user registration.

»»» Important

- The e-mail address is case-sensitive. Make sure the case is correct.

Password

Enter the password that you entered in the user registration.

Keep login info

When you select the check box, the login screen is skipped for 14 days since the last day that the service screen was accessed.

Reset password from here

Select this if you forgot the password.

Reset your password by following the instructions on the screen.

Create new account

A new registration will be added to the Canon Inkjet Cloud Printing Center.

For a new registration, you need the [Printer registration ID](#).

About this service

This displays the descriptions of this service.

System requirements

This displays the system requirements for the Canon Inkjet Cloud Printing Center.

Software license info

The licensing information of Canon Inkjet Cloud Printing Center is displayed.

Description of the Main screen

When you log in to the Canon Inkjet Cloud Printing Center, the Main screen appears.

If you are using a smartphone or a tablet, you can also print photos and documents.

»» Important

- With this service, the available functions differ depending on whether the user is the [Administrator](#) or [Standard user](#) of the printer, and also on the management method that was set.

You can use areas shown below to start, add, and manage apps.

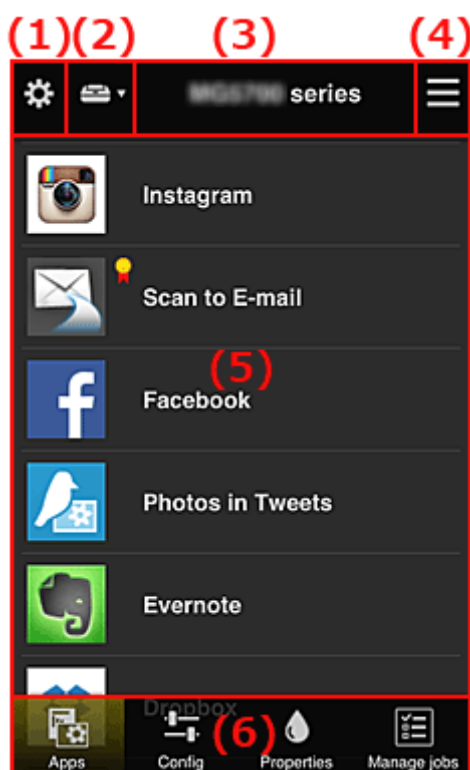

(1) [Left context menu \(Administrator only\)](#)

(2) [Select printer](#)

(3) [Printer name area](#)

- (4) [Right context menu](#)
- (5) [Display area](#)
- (6) [Menu area](#)

(1) Left context menu (Administrator only)

When you select , the left context menu appears.

When you select **Mng. printer**, **Manage users**, **Group management**, or **Advanced management**, the corresponding screen appears.

▶▶▶ Note

- **Group management** appears only when you use [Select how to manage](#) and set **Manage by group (for office users)**.

Mng. printer screen

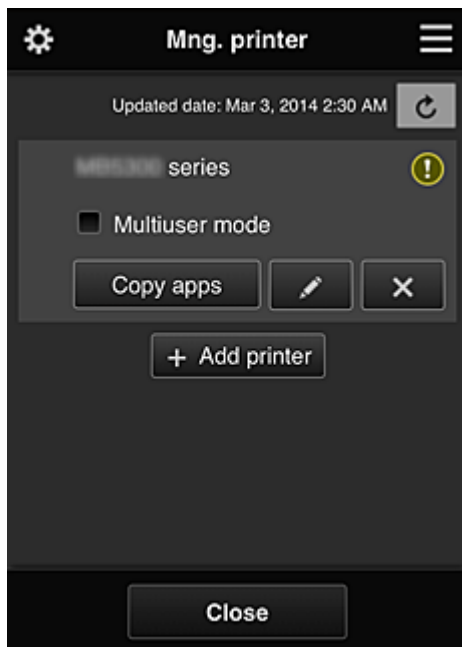

From the **Mng. printer** screen, you can [check](#) or [update](#) printer information registered to the Canon Inkjet Cloud Printing Center, [copy apps](#), [change printer names](#), [delete printers](#), and [add printers](#).

- **Check the printer information**

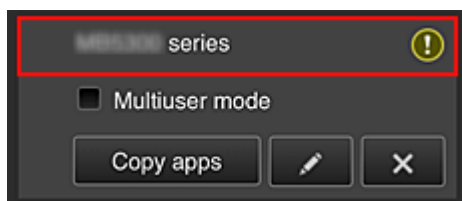

The registered printer name is displayed.

 indicates that an error occurred on the printer.

- **Display update date/time of the printer information**

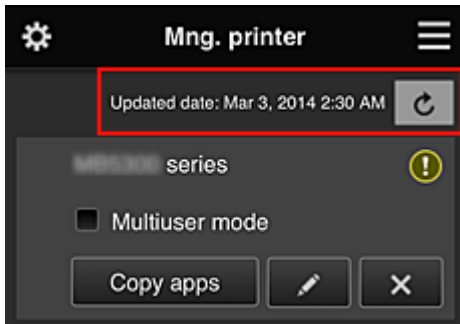

This displays the date and time the printer information was last updated.

 refreshes the information.

- **Multiuser mode (MAXIFY series only)**

If multiple users will be using the printer, add a check mark to [Multiuser mode](#).

The check mark is linked to the **Require security code** screen.

- **Copy apps**

Select this to copy apps added in the selected printer to another printer.

When you select , the screen shown below appears.

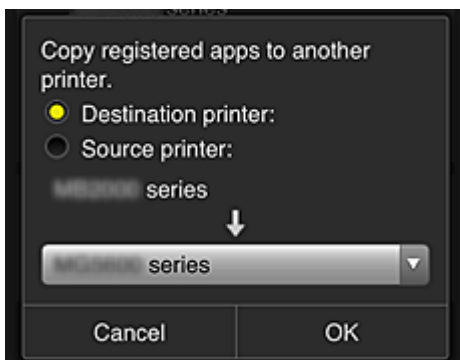

Set the **Destination printer** and the **Source printer**. Then select **OK**.

▶▶▶ Note

- If **Select how to manage** has been set, you can use this function only when you select **Manage app availability by printer**.
For details, see "[Tips on Using Canon Inkjet Cloud Printing Center \(at Work\)](#)".

- **Change the printer name**

When you select , a screen to change the printer name appears.

Follow the instructions on the screen to change the name.

▶▶▶ Important

- The printer name entry has the following character limitation:
 - Up to 128 characters (Uppercase and lowercase letters are differentiated.)

- **Delete printers**

When you select , the printer is deleted from the Canon Inkjet Cloud Printing Center.
When transferring the ownership of the printer, select **Clear the information saved on the printer**.

- **Add printers**

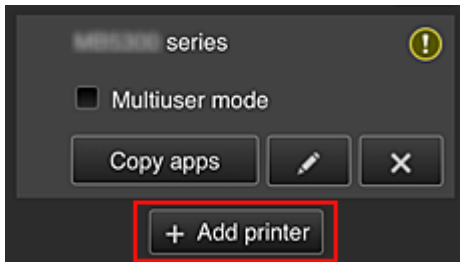

Select this to add printers to be used in the Canon Inkjet Cloud Printing Center.
You need a [Printer registration ID](#) to add a printer.

➤➤➤ **Note**

- Although the number of printers that can be registered for one domain is not limited, only up to 16 printers are guaranteed to operate.

Manage users screen

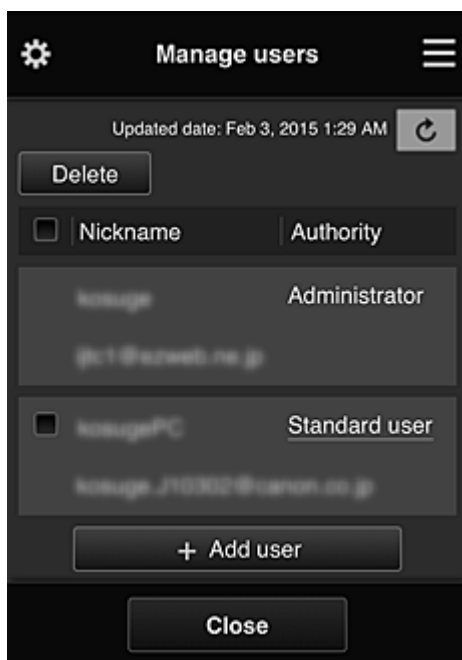

From the **Manage users** screen, you can check user information registered to the Canon Inkjet Cloud Printing Center, [delete users](#), [add users](#), and [change the Administrator and Standard user settings](#).

- **User deletion**

Select the check box of the user to be deleted, and select **Delete**.
However, you cannot delete yourself. To delete yourself, cancel your membership from the [My account](#) screen.

- **Adding a user**

Select **Add user**. The user registration screen appears.

- **Changing Administrator and Standard user settings**

To change the privileges of the **Administrator** or a **Standard user**, select **Authority** for the user whom you want to change the settings for.

Group management screen

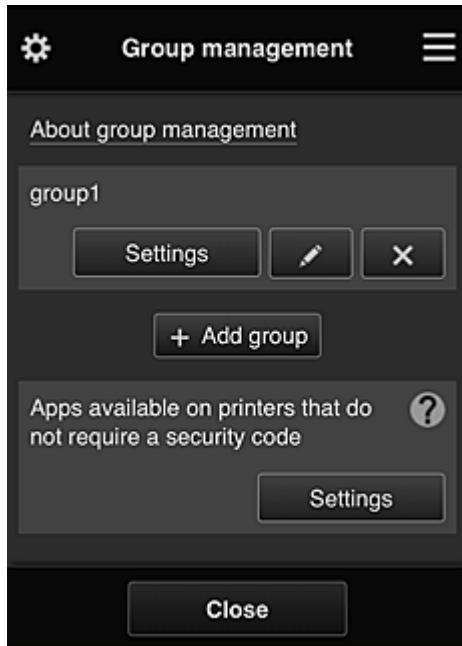

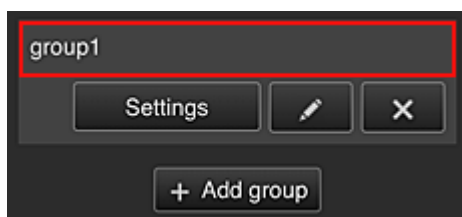

From the **Group management** screen, you can use functions for [checking group information](#) registered to Canon Inkjet Cloud Printing Center, [changing groups](#), [deleting groups](#), [adding groups](#), and setting up users, printers, and apps belonging to each group.

- **Checking group information**



The registered group names appear.

If there are items that have not been set,  appears.

Select  to display the following screen, which allows you to set up information for each group.

The displayed information changes depending on the selected tab.

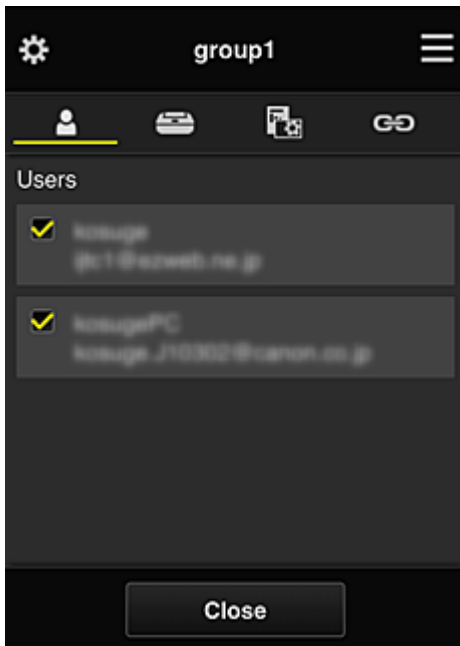

 **Users**

Displays all users and mail addresses registered in the domain.

 **Printers**

Displays all printers registered in the domain.

 **Apps**

With the default settings, the screen displays all apps. To display only registered apps, select the **Registered** category.

To switch between app registration/deletion, select ON / OFF.

 **Web services**

Displays the external link service.

You can restrict the use of other web services that use Canon Inkjet Cloud Printing Center accounts such as Easy-PhotoPrint+.

To switch between service linking/release, select ON / OFF.

 appears for items that do not have anything selected.

In the default settings, all check marks are cleared for **Printers** and **Users**. Only the system apps under **Apps** are set to **ON**.

• **Changing a Group name**

To display the **Group name** change screen, select .

You can change the name to one of your liking by following the instructions in the displayed screen.

Important

- When you enter a **Group name**, the following restrictions apply:
 - When using single-byte alphanumeric characters, enter at least 1 but not more than 20 characters. When using double-byte characters, enter at least 1 but not more than 10 characters.

- Duplicate group names cannot be registered in the same domain.

• Deleting a Group

To delete a group from Canon Inkjet Cloud Printing Center, select .

If you delete all groups, you must create a new one. To set a different management method, set the target method from the **Select how to manage** screen.

• Add group

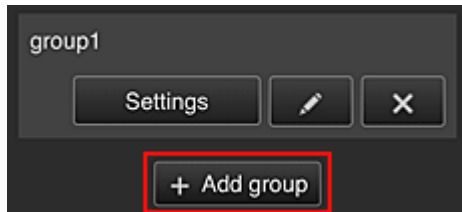

Add a group to be used in Canon Inkjet Cloud Printing Center.

▶▶▶ Note

- You can register up to 20 groups.

• Apps available on printers that do not require a security code

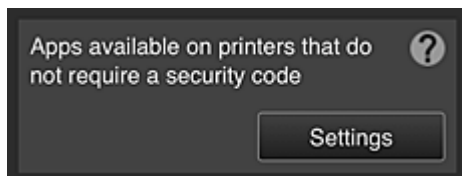

For printers without the **Multuser mode** setting or **Security code** settings, set the apps to be

displayed when a user selects  **Cloud** from the printer's home screen.

If the domain does not have a printer that meets this condition, this setup screen does not appear.

To go to the setup screen, select .

▶▶▶ Note

- If only the following printer is registered in the domain, it is not displayed.
 - Printer without LCD monitor
 - Printer with monochrome LCD monitor
 - Multuser mode printer

Advanced management screen



The **Advanced management** screen allows you to set the management method for printer users and apps that can be used.

To go to the setup screen, select .

- **Require security code**

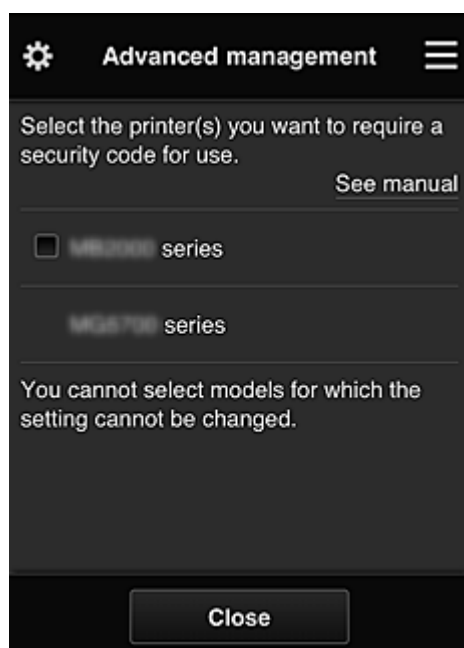

Each user can set a [Security code](#), start the app, and perform printing and other operations. This setting is linked with **Multuser mode** on the **Mng. printer** screen.

▶▶▶ Note

- The list does not display models without an LCD or models with a monochrome LCD.
- The check box does not appear for models that do not support **Multuser mode**.

- **Select how to manage**

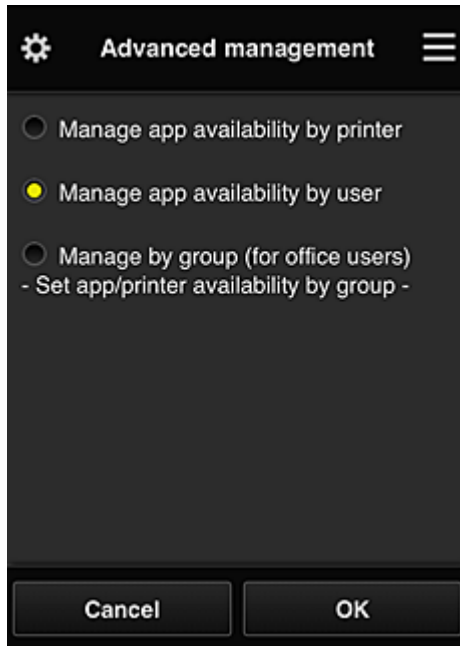

You can change the management method for usable apps and printers.

Manage app availability by printer

If you are using multiple printers, you can manage the useable apps for each printer.

Manage app availability by user

When one printer is used, you can manage the usable apps by user.

For usage examples, see "[Tips on Using Canon Inkjet Cloud Printing Center \(at Home/If you are using PRO-1000 series or PRO-500 series\)](#)".

Manage by group (for office users)

You can manage the usable apps and printers by group.

For usage examples, see "[Tips on Using Canon Inkjet Cloud Printing Center \(at Work\)](#)".

»» Note

- If you manage the usable apps by printer, the default settings will allow all users to add, delete, and rearrange apps.
Also, if you are using a MAXIFY series printer and you select **Multuser mode** in the [Mng. printer screen](#), only the administrator will be able to add, delete, and rearrange apps.
- If you manage the usable apps by user, all users will be able to add, delete, and rearrange apps, regardless of the **Multuser mode** setting.
- If you manage the usable apps and printers by group, all users will only be able to rearrange apps.

(2) Select printer

Select , and then from the **Select printer** screen, select a printer.

If you are using a computer, you can select a printer directly from the pull-down menu.

»» Note

- Printers with settings that restrict their use do not appear.

(3) Printer name area

The registered name of the printer selected is displayed.

The **Administrator** can [change the printer name](#) from the **Mng. printer** screen of the left context menu.

(4) Right context menu

When you select , the context menu appears.

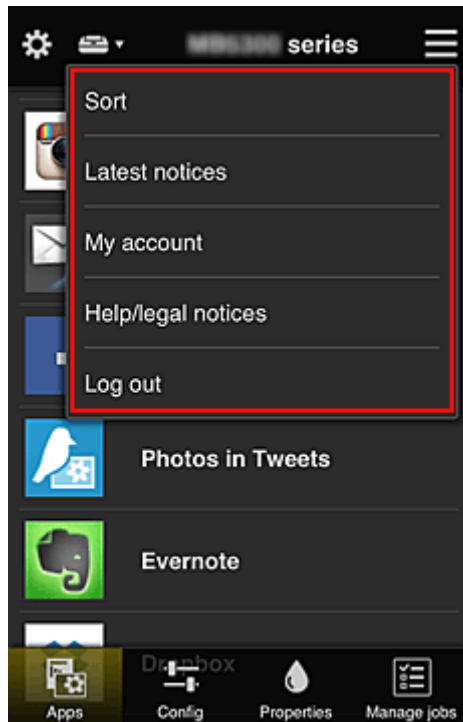

The information displayed depends on the menu currently selected in the menu area.

The  symbol indicates that there is a new unread notice.





• **Sort** **Sort**

This displays the screen to sort registered apps.

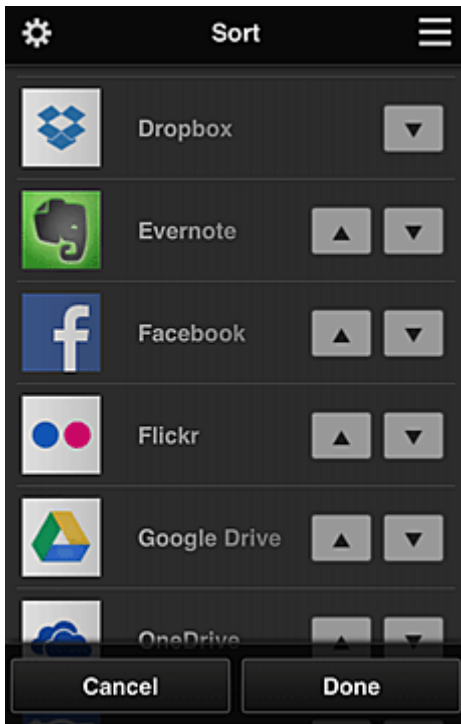
You can use the   buttons to change the display order of apps. When you finish sorting, select **Done**.



➤➤➤ Note

- Description of displayed icons
 -  : Cannot be used because it is not yet released or does not support your region, model, or language.
 -  : Can be used with genuine Canon ink.

If you are using a G3000 series model, you cannot use this service because the model is not supported.

• **Latest notices** Latest notices

This displays the latest notices. The  symbol indicates that there is a new unread notice.

• **My account** My account

Displays user information.

From the **My account** screen, you can change your account settings.

From the **My account** screen, you can display the **Permitted services** screen and clear any linked service setting.

• **Help/legal notices** Help/legal notices

The description of the Canon Inkjet Cloud Printing Center screen and various reminders are displayed.

• **Log out** Log out

This opens the Log out screen of the Canon Inkjet Cloud Printing Center.

(5) Display area

The display changes based on the menu you select.

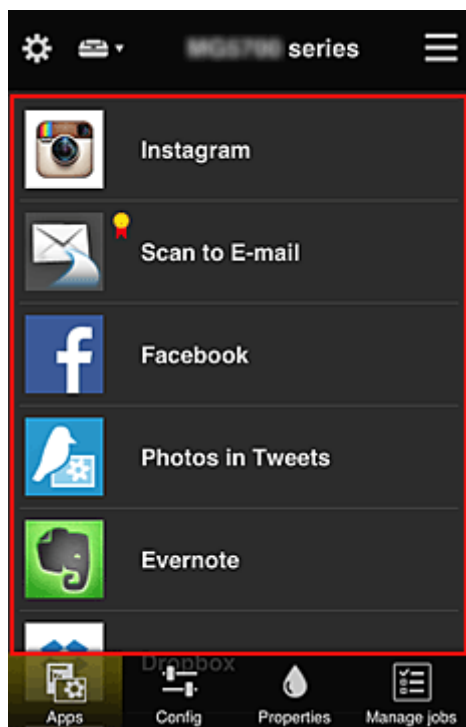

(6) Menu area

The following 4 menu buttons are displayed:

-  **Apps**

This displays the list of registered apps in the [Display area](#).

-  **Config**

This displays the Register apps screen in the [Display area](#).

The display can be toggled between **Registered** and **Search apps**.

The **Registered** screen lists registered apps.

You can check the information of these apps or deregister them.

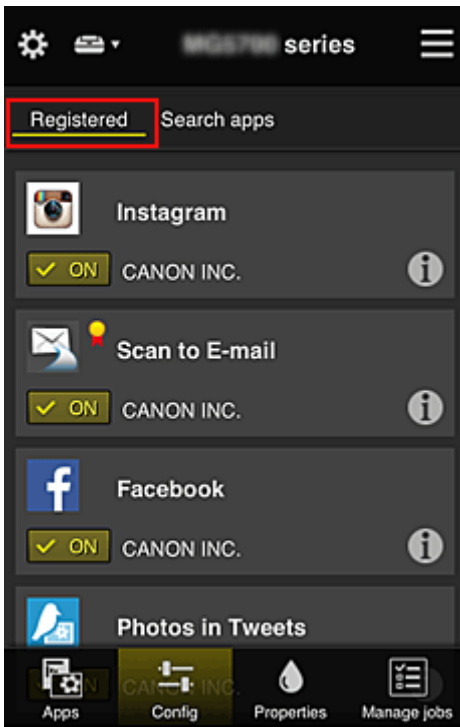

»» Note

- If **Group management** has been set, **Config** is not displayed.
- If **Manage app availability by user** has been set, even **Standard user** can register and delete apps.

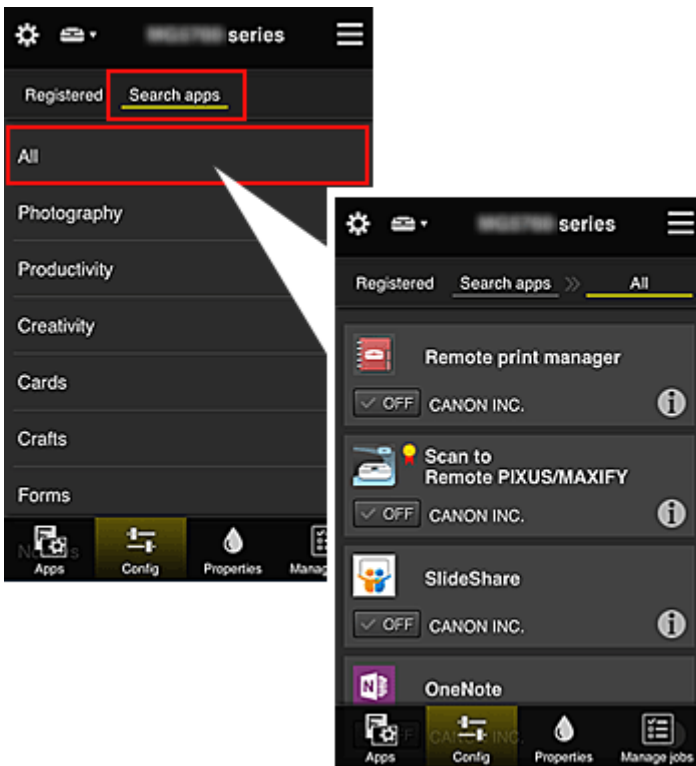

On the **Search apps** screen, the apps that you can register by using the Canon Inkjet Cloud Printing Center are displayed by category.



- When you select , the details of the app are displayed.
- When you select  / , you can choose to register or unregister the app.

➤➤➤ Note

- Description of displayed icons
 -  : Cannot be used because it is not yet released or does not support your region, model,

or language.

 : Can be used with genuine Canon ink.

If you are using a G3000 series model, you cannot use this service because the model is not supported.



- **Properties**

This screen displays the status of the printer that is currently selected.

You can check how much ink is remaining or details about an error that occurred. You can also access the ink purchasing site and the Online Manual.

Important

- The Properties displayed may differ from the actual status at the display time, depending on the printer status.



- **Manage jobs**

This screen displays the print or scan status and history.

You can check the print or scan status by looking at **Status list**, and the print or scan history by looking at **History**.

You can also cancel print or scan jobs and delete history information.

To cancel or delete a job, select that job and then select **Cancel** or **Delete**.

Tips on Using Canon Inkjet Cloud Printing Center (at Home/If you are using PRO-1000 series or PRO-500 series)

The **Advanced management** function allows you to take advantage of the many useful functions that the service offers for home use.

This section introduces those functions by using a family of 3 (father, mother, and child) as an example.



If the father registers the printer to Canon Inkjet Cloud Printing Center, only the father is managed by the service, and the mother and the child cannot use the service unless the father tells them the login **E-mail address** and **Password**.

If Mother and Child Want to Use the Service from Their Smartphones

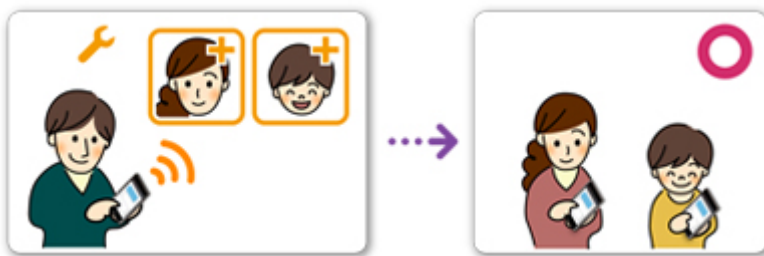

1. The father [registers to Canon Inkjet Cloud Printing Center](#) and becomes the **Administrator**
2. After logging in, the father selects [Manage users](#) from 

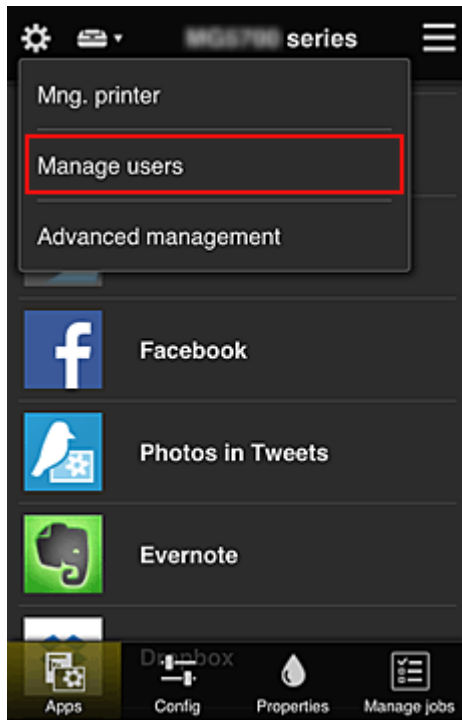

3. The father selects **Add user**, and by following the screen instructions, registers the mother and child as users.

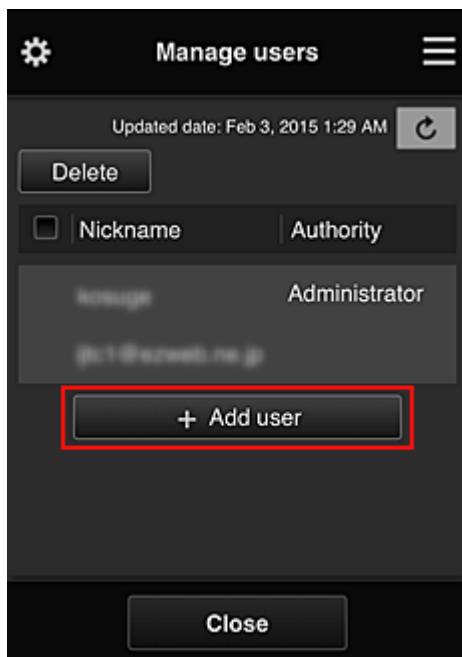

After this registration is complete, the mother and child can individually use the service.

If Father, Mother, and Child Want to Manage Apps Individually



With the default settings, only the **Administrator** (father) can register apps to be used or delete apps. After the **Administrator** (father) specifies settings according to the procedure below, the father, the mother, and the child will be able to manage apps individually.

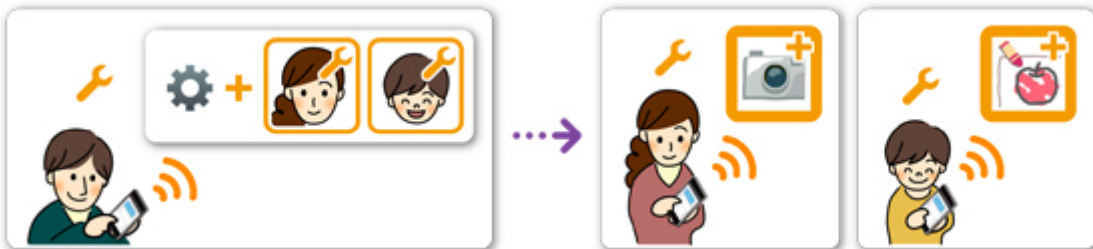

1. As the **Administrator**, the father [logs in to Canon Inkjet Cloud Printing Center](#) and selects **Advanced management** from 

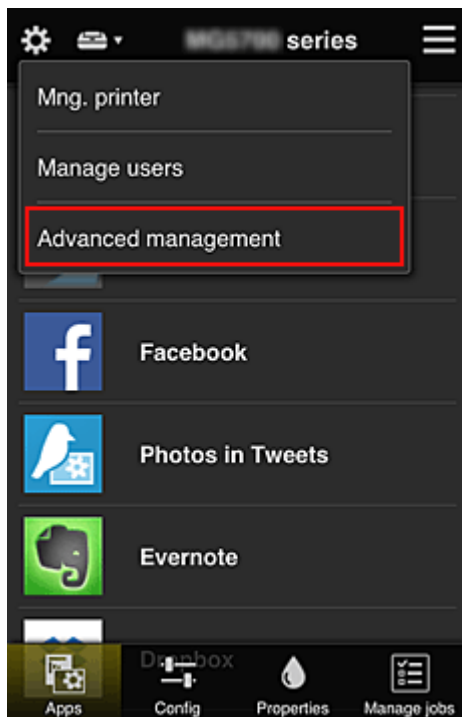

2. For **Select how to manage**, the father selects **Set**



3. The father sets **Manage app availability by user** and selects **OK**

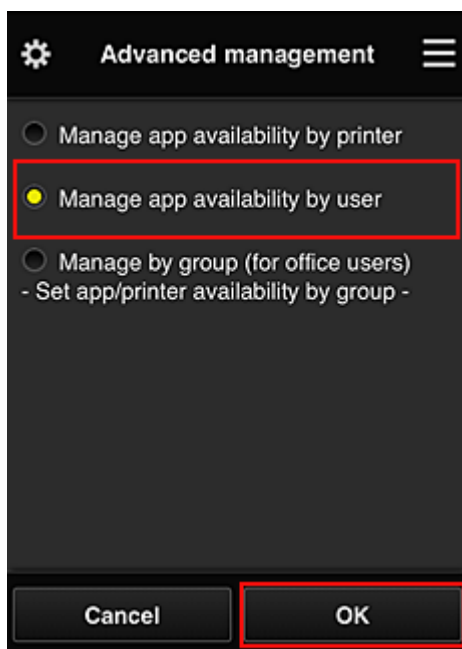

4. The screen for checking the management method change appears

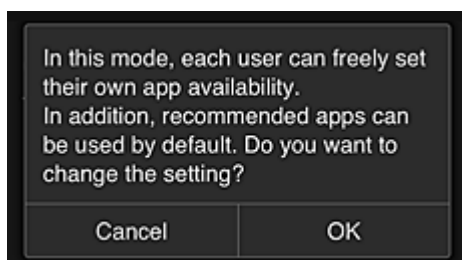

To complete the setup and return to the **Advanced management** window, select **OK**.

All registered users can register and delete apps freely.

Tips on Using Canon Inkjet Cloud Printing Center (at Work)

The **Group management** function allows you take advantage of the many useful functions that the service offers for office use.

This section introduces an example in which two printers are used, the **Administrator** is the senior clerk, and the other members are the company president, the section manager, and the new hire.

»» Note

- If the second printer has not been registered, select "[Adding a Printer](#)" and register the printer by following the procedure.

Creating a Group for All Office Members to Use

Set the basic group.

In this example, only the Evernote app will be used on 2 printers.

1. The senior clerk [registers to Canon Inkjet Cloud Printing Center](#) and becomes the **Administrator**
2. The senior clerk selects [Manage users](#) from 

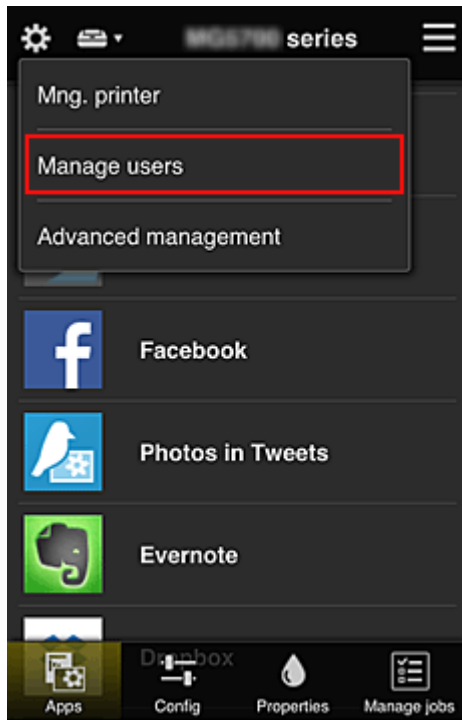

3. On the displayed screen, the senior clerk selects **Add user** and registers the company president, the section manager, and the new hire as users

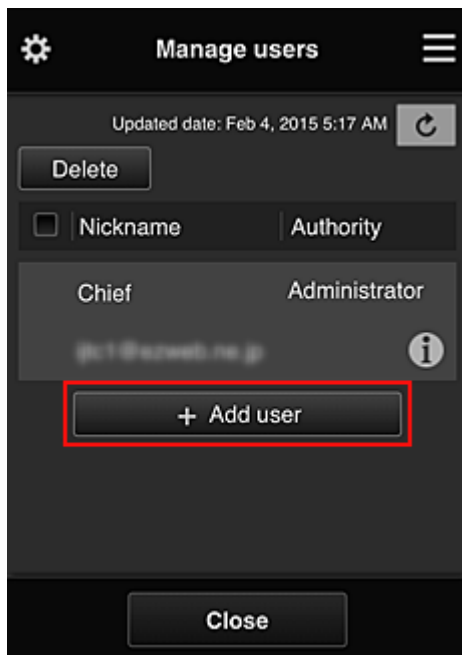

4. The senior clerk selects **Advanced management** from 

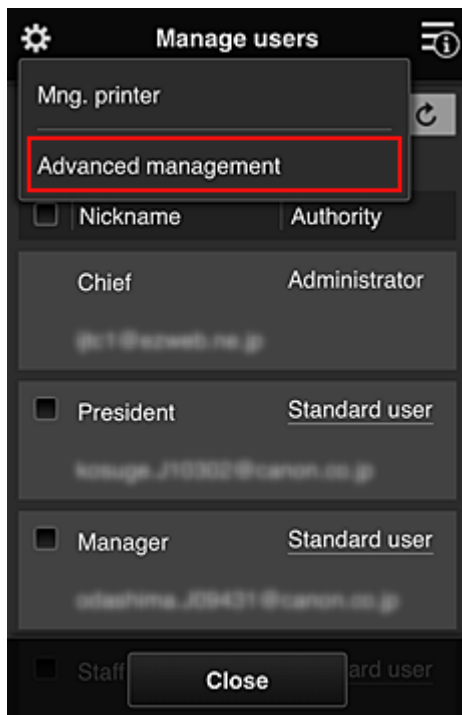

5. For **Select how to manage**, the senior clerk selects **Set**

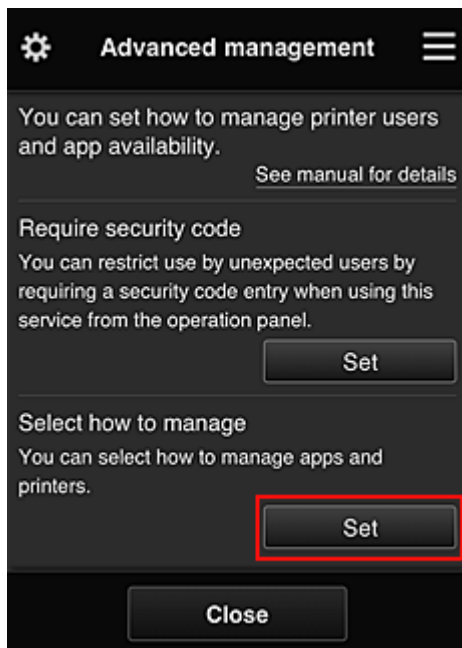

6. The senior clerk sets **Manage by group (for office users)** and selects **OK**

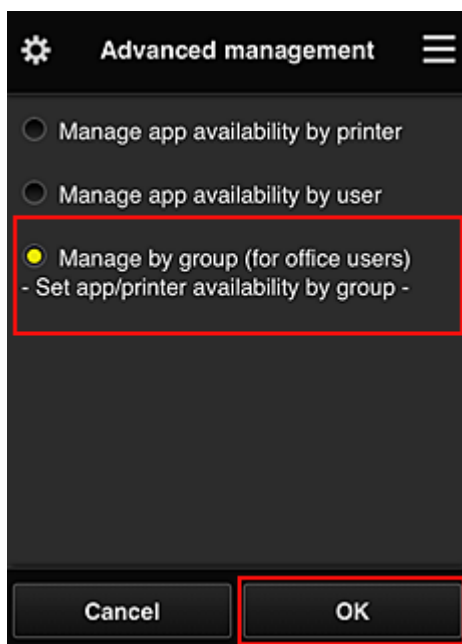

➤➤➤ **Note**

- If **Group management** has already been set up, refer to step 10 and the subsequent steps.

7. On the screen for checking management method changes, the senior clerk checks the displayed information and selects **OK**.

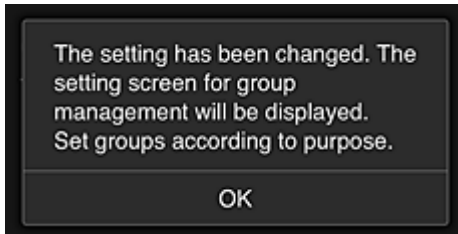
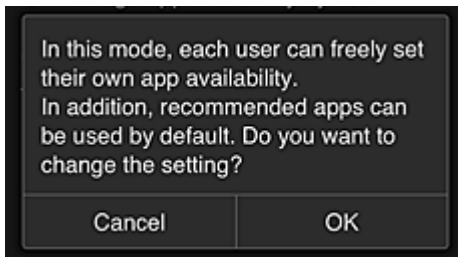

This appears only if the selected mode is **Group management**.

To complete the setup and display the **Group management** screen, select **OK**.

➤➤ Note

- With the default settings, the group is named "group1".
- With the default settings, all registered users belong to the same group.

8. In the **Group management** screen, the senior clerk selects the  of the group to be renamed

9. The senior clerk enters the **Group name** and selects **OK**

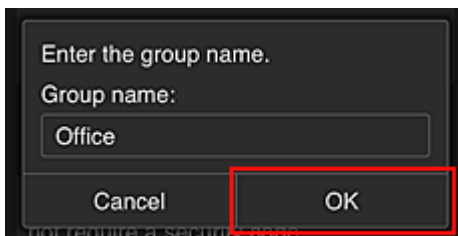

The chief clerk enters "Office" here because the clerk is setting up a group that everyone in the office will use.

➤➤ Important

- The following restrictions apply to entering the **Group name**.
 - The group name can have up to 20 single-byte alphanumeric characters or up to 10 double-byte characters.
 - The same group name cannot be registered more than once in the same domain.
 - Up to 20 groups can be registered.
- The person who created the group becomes the **Administrator**.

10. Select **Settings**, and in group setup screen, check that all users on the **Users** tab are selected

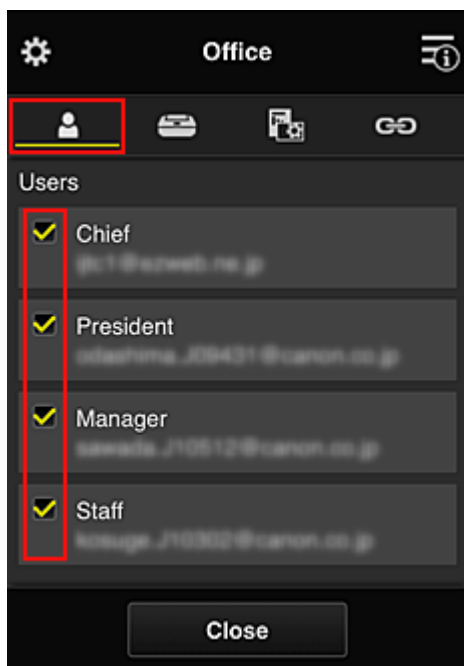

11. On **Printers** tab, check that all printers are selected

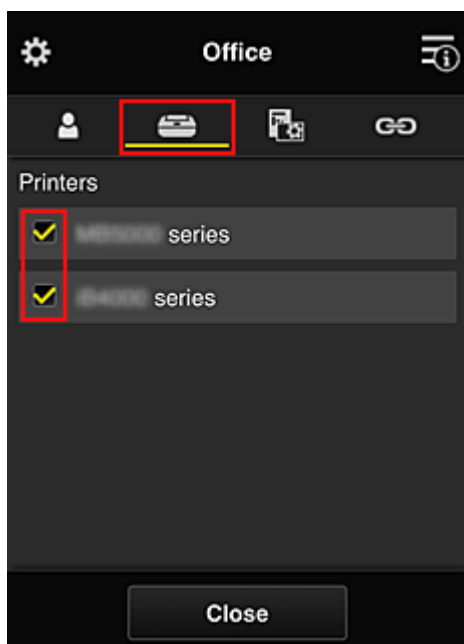

12. On **Apps** tab, set only Evernote app to ON

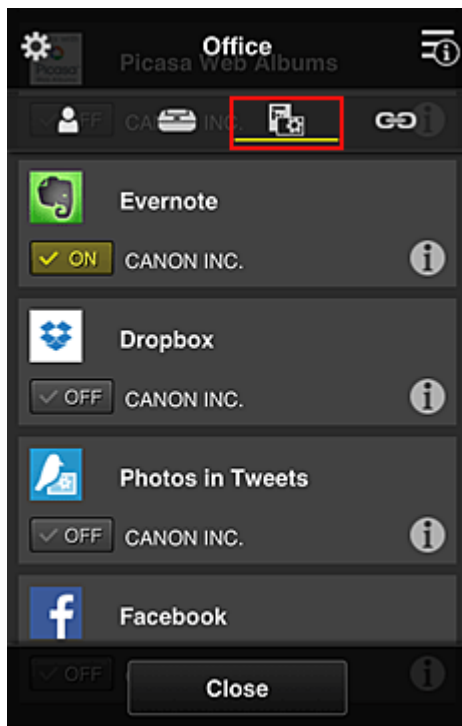

To switch between app registration/deletion, select ON / OFF.
To return to the **Group management** screen, select **Close**.

This completes the setup of the group to be used by the entire office.

»» Note

- The group setup screen displays all users and printers that are registered in the domain.
- If you want to set up new apps as an individual, you can add a group.
To create a new group, use **Add group**, and then in the setup screen for the added group, add users and printers.

- [Limiting Apps That Each User Can Use](#)
- [Limiting Apps That All Members Can Use on Printer](#)
- [Limiting Apps That Individual Users Can Use on Printer](#)
- [Limiting Printers That Individual Users Can Use](#)

»» Important

- The available apps may differ depending on the country or the region.

Limiting Apps That Each User Can Use

Set the following:

- Entire office: Use only Evernote app
- President: Use Evernote app and Facebook app

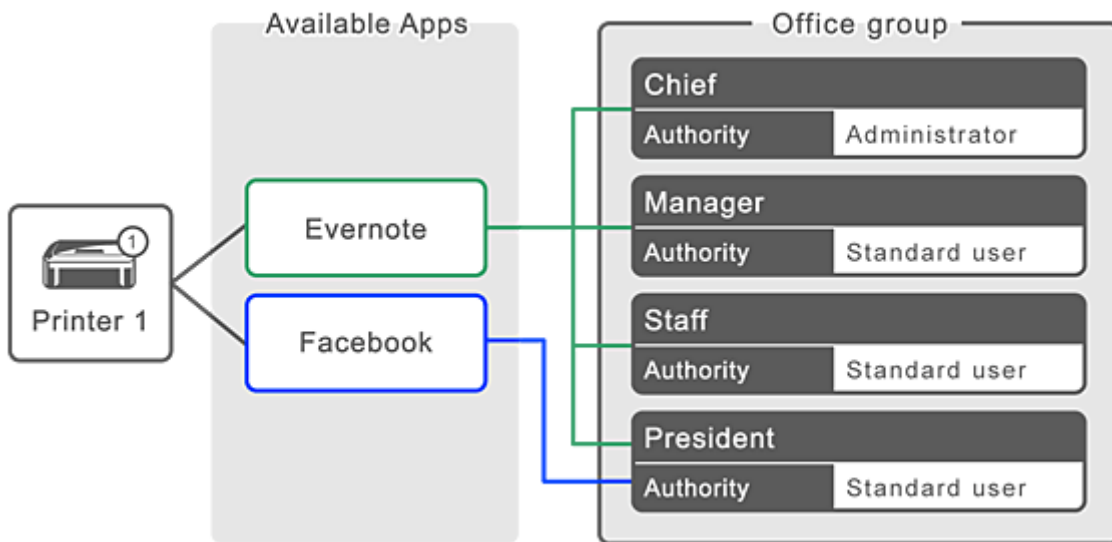

1. From , select **Group management**

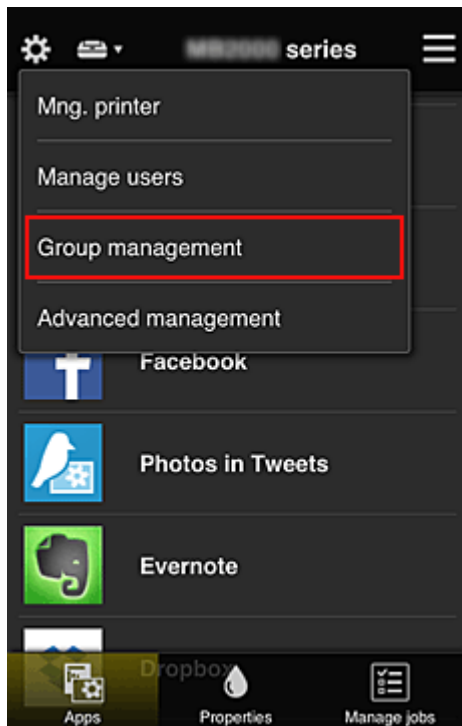

➤➤➤ Note

- This appears only if **Manage by group (for office users)** is set in **Advanced management**.

2. In displayed screen, select **Add group**

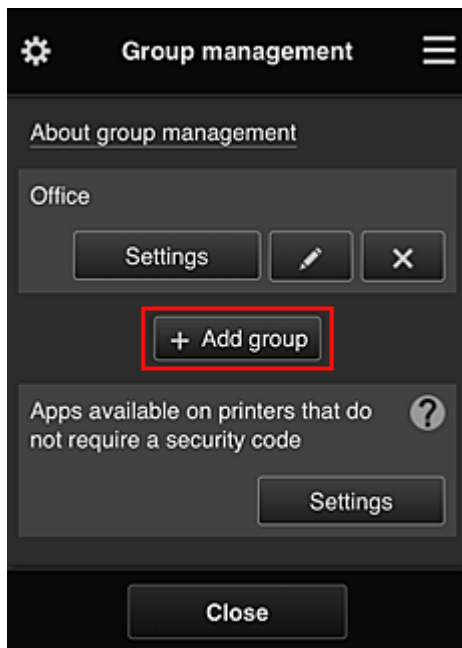

3. The senior clerk enters the **Group name** and selects **OK**

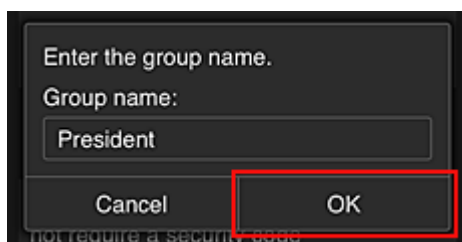

In this field, enter "President" as the president-only group because you will be setting apps that only the president can use.

»»» Important

- The following restrictions apply to entering the **Group name**.
 - The group name can have up to 20 single-byte alphanumeric characters or up to 10 double-byte characters.
 - The same group name cannot be registered more than once in the same domain.
 - Up to 20 groups can be registered.
- The person who created the group becomes the **Administrator**.

4. Follow messages displayed on screen, and select **OK**

The group setup screen appears.

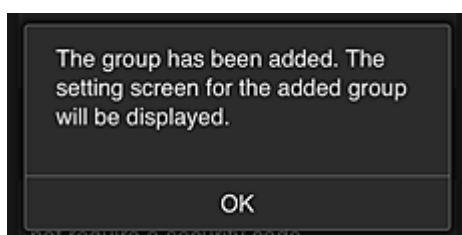

5. On **Users** tab, select only president

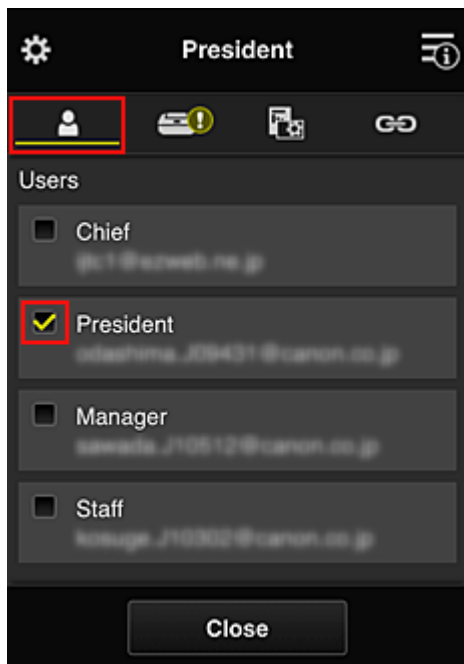

6. On the **Printers** tab, select printer to be used.

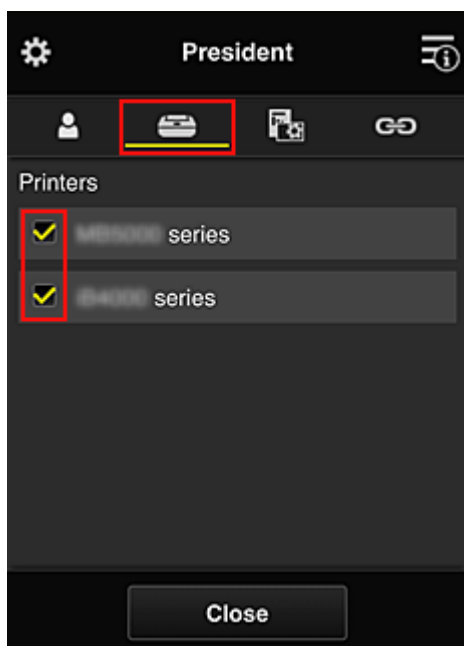

7. On the **Apps** tab, set the Evernote and Facebook apps to 

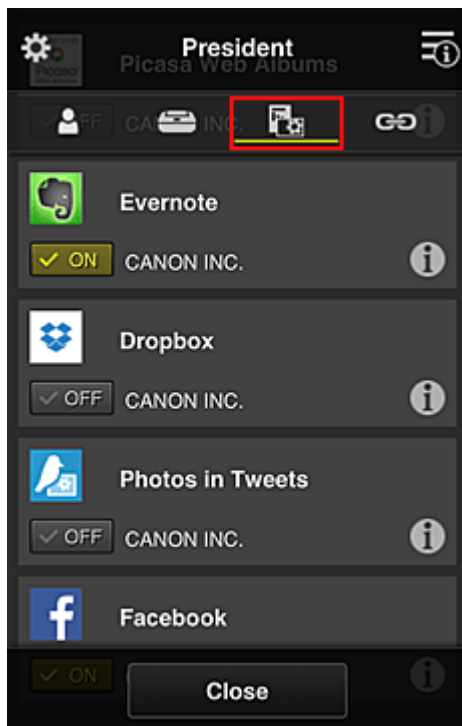

To switch between app registration/deletion, select ON / OFF.

To return to the **Group management** screen, select **Close**.

The above procedure allows you to set apps that only the president can use.

➤➤ Note

- The group setup screen displays all users and printers that are registered in the domain.

Limiting Apps That All Members Can Use on Printer

To set the apps to be used on the printer, use the following procedure provided by this service.

As an example, this section describes the procedure for allowing all users to use the Evernote app from the printer.

1. From , select **Group management**

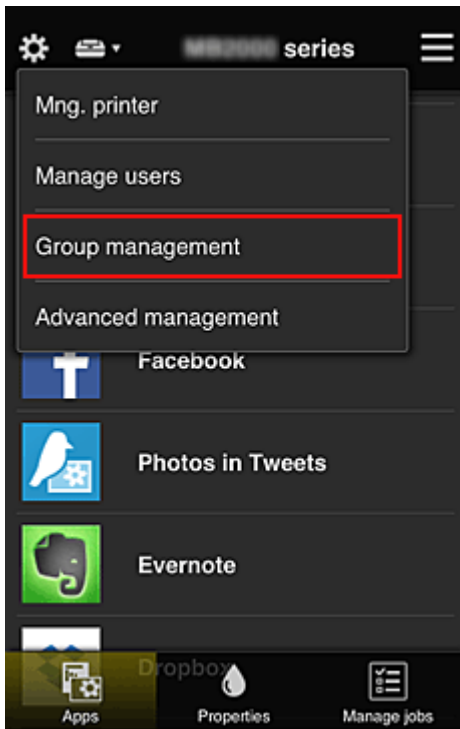

➤➤➤ **Note**

- This appears only if **Manage by group (for office users)** is set in **Advanced management**.

2. For **Apps** available on printers that do not require a security code, select **Settings**

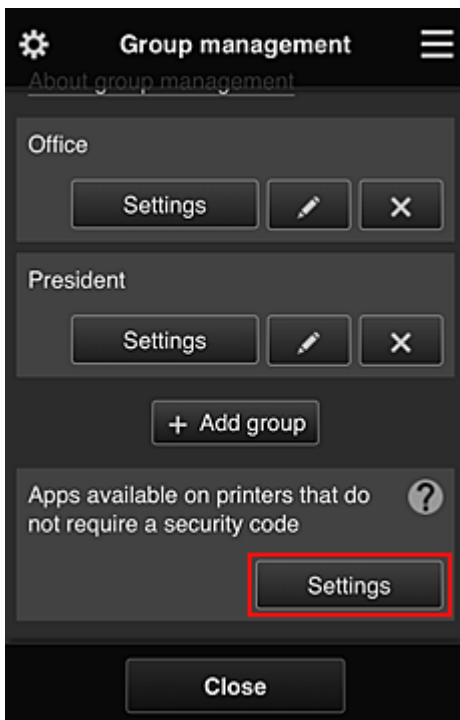

3. On **Apps** tab, set only Evernote app to 

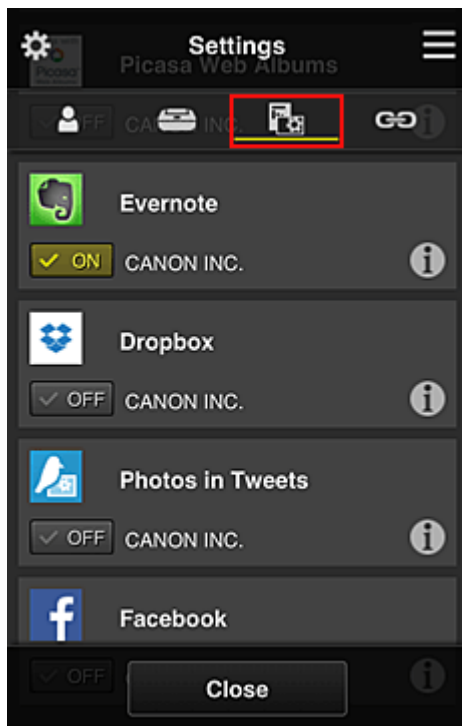

To switch between app registration/deletion, select ON / OFF.

To return to the **Group management** screen, select **Close**.

The above procedure sets up Evernote as the only app that all users can use on the printer.

Limiting Apps That Individual Users Can Use on Printer

For each user, you can set the apps that the user can use on the printer.

As an example, this section describes the procedure for allowing only the president to also use the Facebook app from the printer.

1. From , select **Advanced management**

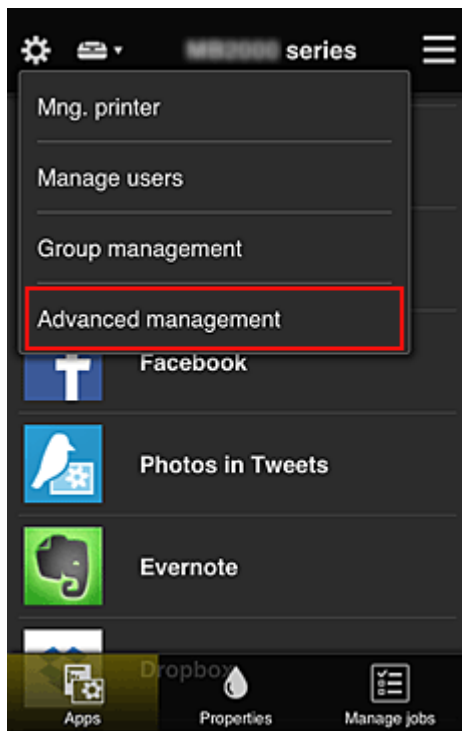

2. For **Require security code**, select **Set**.



3. Select printer for setting up **Security code**.

[Security codes](#) identify individual users when multiple users are using a printer.

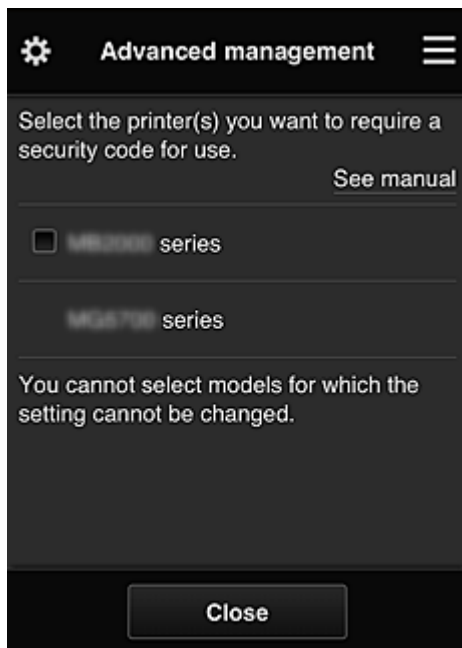

➤➤➤ Note

- On models where the settings cannot be changed, this function cannot be selected. Some models do not support this function. To check whether your model supports this function, see "Models that Support Security Codes".

4. Set up **Security code**

If there are users who have not set up a **Security code**, a screen appears for checking whether to send an e-mail prompting those users to set up a **Security code**.



To send a notification e-mail only to users without a **Security code**, select **OK**.

To display the **Security code** setup screen when each user logs in and not send the notification e-mail, select **Cancel**.



»» Important

- The following character restriction applies to **Security code** entries:
 - Up to 8 alphanumeric characters

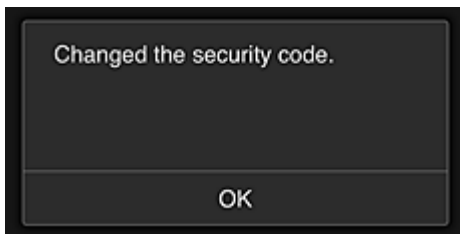

The **Security code** change process ends, and the change completion message appears. In the message screen, select **OK** to return to the main screen.

5. Select  **Cloud** from the printer's home screen

6. In **Switch user** screen, select user



7. Enter **Security code** that you set and **Log in**

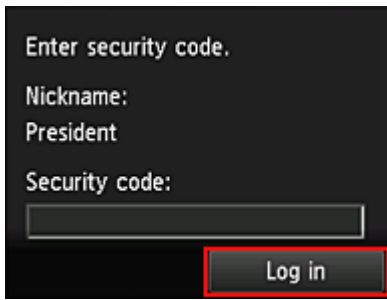

➤➤➤ **Note**

- If you have not set a **Security code**, set a **Security code** from [My account](#), and then **Log in**.

8. Select Facebook app

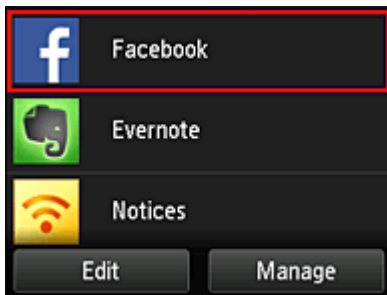

Only the president will be able to use the Facebook app from the printer.

Limiting Printers That Individual Users Can Use

As an example, this section describes the procedure for setting up one printer for the president and another printer for all users.

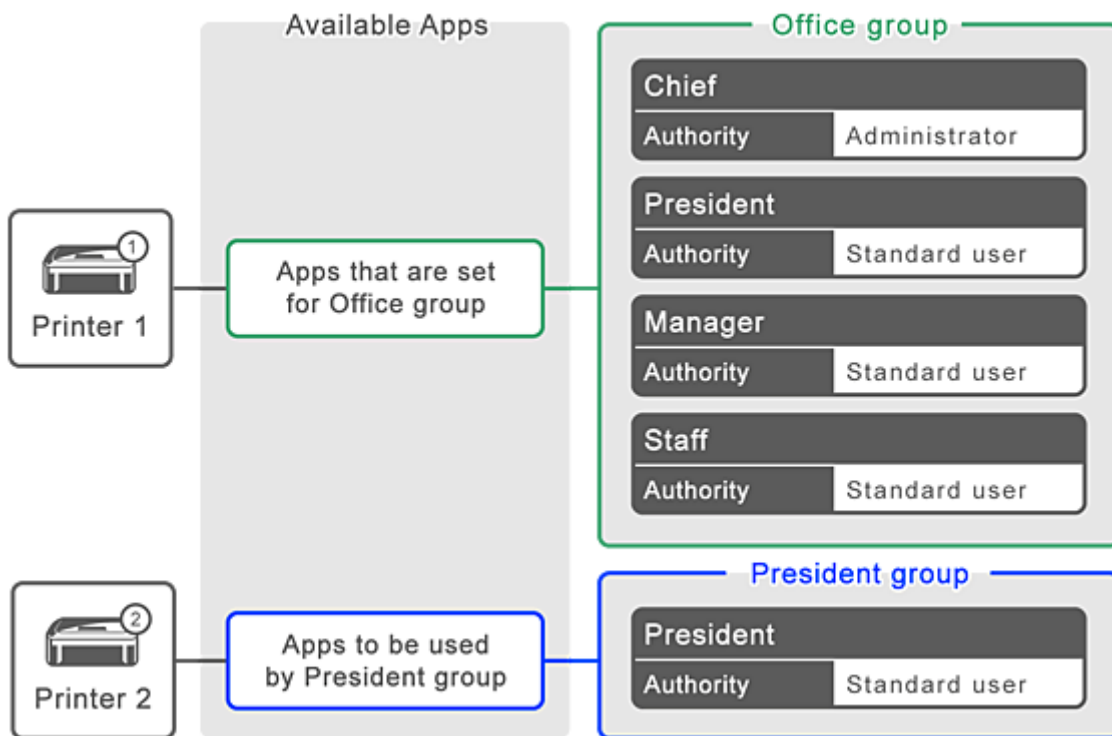

1. From , select **Group management**

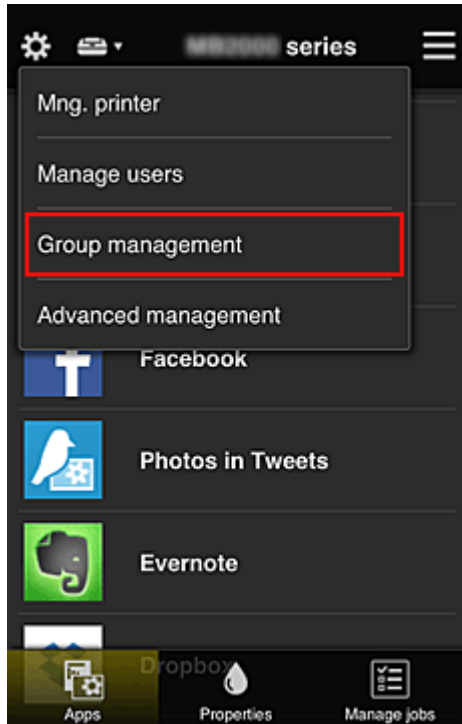

➤➤➤ **Note**

- This appears only if **Manage by group (for office users)** is set in **Advanced management**.

2. Select **Settings** for the group containing all users

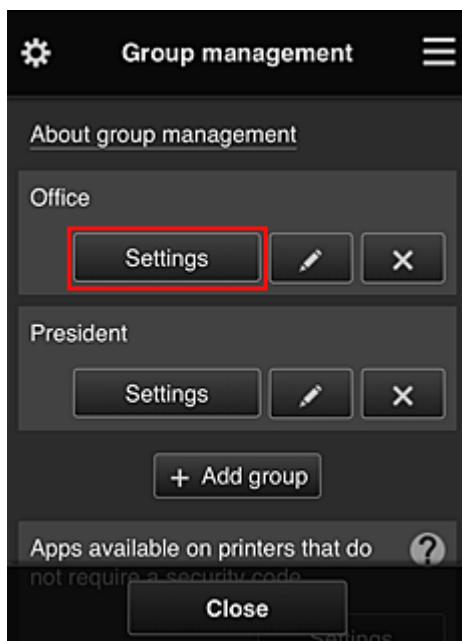

3. On the **Printers** tab, clear printer that was set up for president

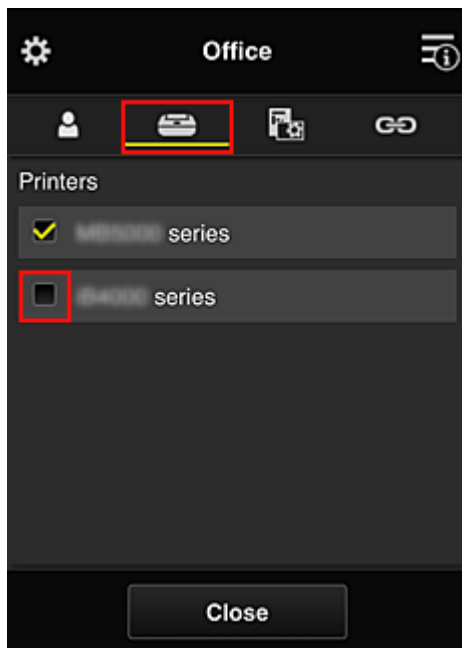

To return to the **Group management** screen, select **Close**.

»» Important

- If a user is being managed in multiple groups and an app is deleted or the target printer is changed for one of those groups, the user can still use that app or printer if the one of the other groups allows it.

Only the printer that was set can be used by all users.

What is a Security code?

A **Security code** identifies the user when multiple other users are sharing the same printer.

Important

- If you are using the MAXIFY series, you can set a **Security code**. We recommend that you set a **Security code** to prevent other users from using your account.
- This code is valid only when you use MAXIFY Cloud Link from the printer operation panel. You cannot use this code when you access the Canon Inkjet Cloud Printing Center from your smartphone, tablet, or computer.

Adding a Printer

With one account, you can use the Canon Inkjet Cloud Printing Center services on multiple printers.

The procedure for adding a printer is as follows:

- [If your model has color LCD monitor](#)
- [If your model has monochrome LCD monitor](#)
- [If your model has no LCD monitor/If you are using PRO-1000 series or PRO-500 series](#)

If your model has color LCD monitor

1. Check that an e-mail containing the URL has been sent to [the registered e-mail address](#), and access the URL
2. Enter the information according to the instructions on the authentication screen, and then select **Log in**

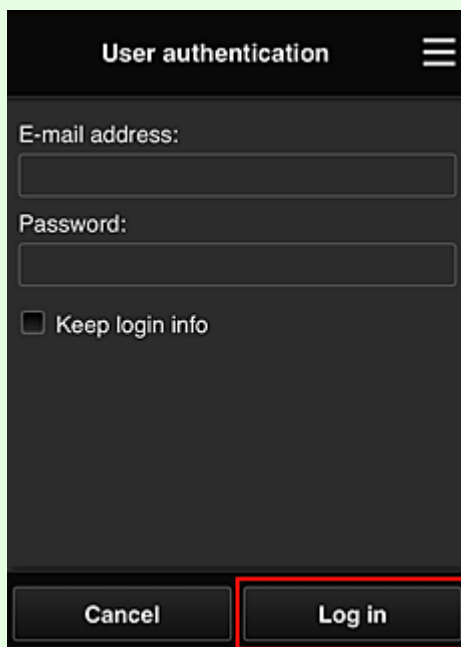

3. When printer addition complete message appears, select **OK**

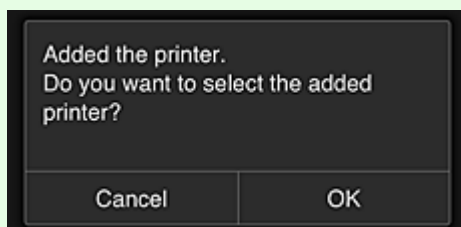

The printer addition process ends, and the main screen of Canon Inkjet Cloud Printing Center appears.

▶▶▶ Note

- If you select **Cancel**, the printer selection status does not change and the main screen of Canon Inkjet Cloud Printing Center appears.

If your model has monochrome LCD monitor If your model has no LCD monitor/If you are using PRO-1000 series or PRO-500 series

1. Check that an e-mail containing the URL has been sent to the registered e-mail address, and access the URL

■ [If your model has monochrome LCD monitor](#)

■ [If your model has no LCD monitor/If you are using PRO-1000 series or PRO-500 series](#)

2. Enter the information according to the instructions on the authentication screen, and then select **Log in**

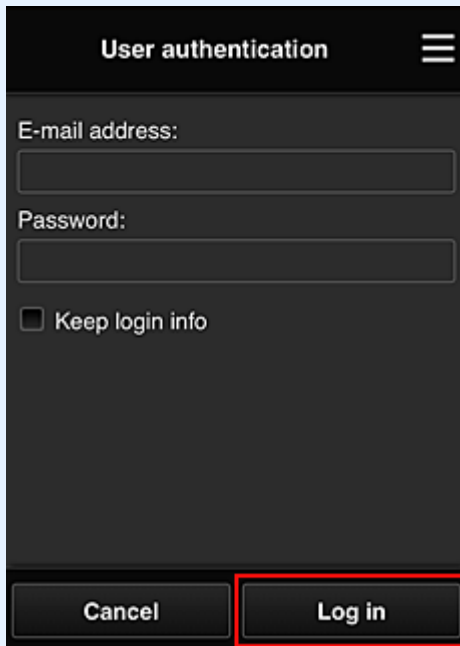

3. When printer addition complete message appears, select **OK**

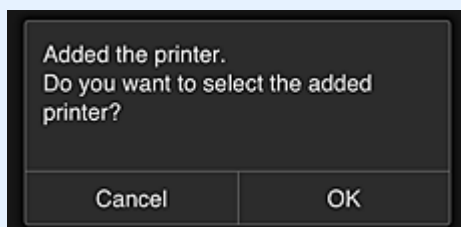

The printer addition process ends, and the main screen of Canon Inkjet Cloud Printing Center appears.

▶▶▶ **Note**

- If you select **Cancel**, the printer selection status does not change and the main screen of Canon Inkjet Cloud Printing Center appears.

■ [Adding a PIXMA/MAXIFY Cloud Link User](#)

Adding a PIXMA/MAXIFY Cloud Link User

Several people can use one printer.

This section describes the user addition procedure and the user privileges.

Adding a user

1. On the service screen, select **Manage users** from .

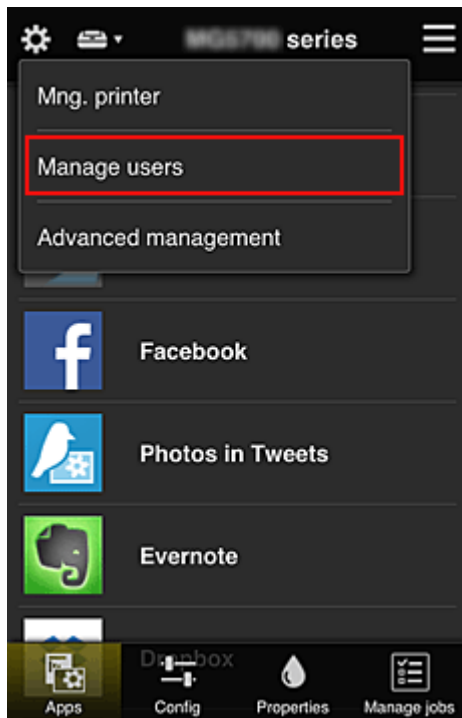

2. Select **Add user**

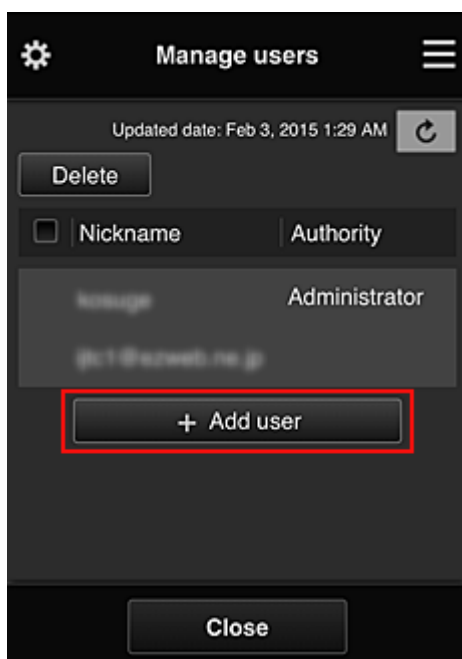

▶▶▶ Note

- When you select **Add user**, the service first checks whether the maximum number of users has been reached. If new users can be added, the user registration screen appears.
- The maximum number of users that can be added for 1 printer is 20.

3. Enter the e-mail address of the user to be added, and then select **OK**

The URL for completing the registration is then sent to the entered e-mail address.

▶▶▶ Note

- If you enter an e-mail address that is already registered, you will receive notification that the address is registered. To specify another e-mail address, follow the displayed instructions.

4. Access the URL reported in the e-mail

The procedure that follows describes what to do if you receive a notification e-mail.

5. Read the terms displayed in the **License agreement** and **Privacy statement** screens. If you agree to the terms, select **Agree**.

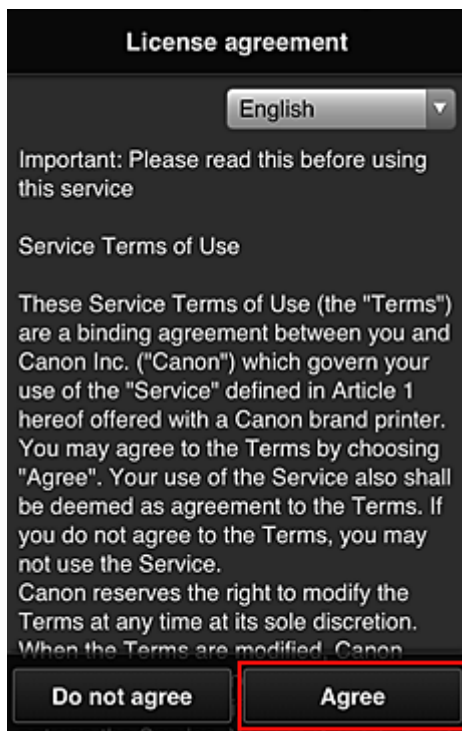

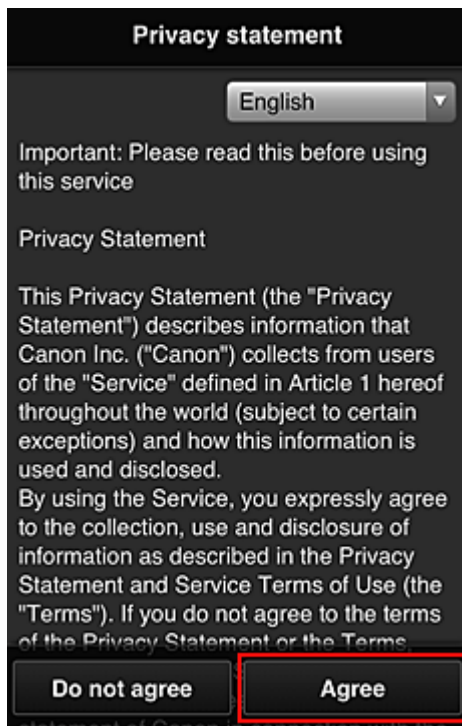

6. Register a password for logging in to the Canon Inkjet Cloud Printing Center.

On the My Account Registration screen, enter you desired password into **Password** and **Password (Confirmation)** and select **Next**.

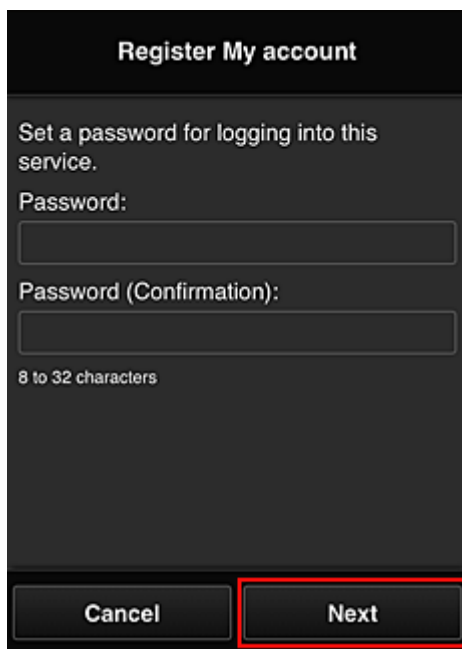

➤➤➤ **Important**

- There are character restrictions for the **Password**, as shown below.
 - The password must be between 8 and 32 characters long, using single-byte alphanumeric characters and symbols (!"#\$%&'()*+,-./:;<=>?@[¥]^_`{|}~). (Alphabets are case-sensitive)

7. Enter **Nickname**

Enter any user name that you want to use.

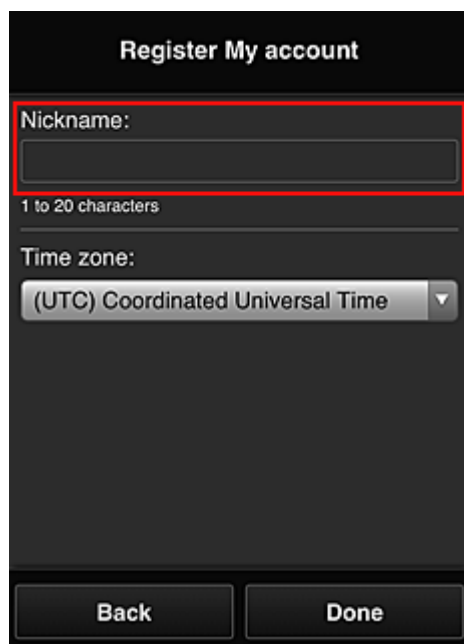

Register My account

Nickname:

1 to 20 characters

Time zone:

(UTC) Coordinated Universal Time

Back Done

»» Important

- The user name entry field has the following character restrictions:
 - The user name must be between 1 and 20 characters long, using single-byte alphanumeric characters and symbols (!"#\$\$%&'()*+,-./:;<=>@[¥]^_`{|}~). (Alphabets are case-sensitive)

8. Specify the **Time zone** setting, and select **Done**

Select your region on the list. If you cannot find your region on the list, select the one closest to your region.

Apply daylight saving time

This appears only when there is a daylight saving time in the **Time zone** that you selected. Select whether or not to apply the daylight saving time.

The main registration is complete, and a registration completion e-mail is sent.

➤➤➤ Note

- When you use MAXIFY Cloud Link, a cookie for the selected user is added to the printer, and the login status of each user is recovered. For each printer, you can register cookies for up to 8 users.

Printer user privileges

If several users are using the cloud service for 1 printer, each user is categorized as the **Administrator** or a **Standard user**.

➤➤➤ Note

- The user who is registered first becomes the **Administrator**. The administrator can change the privileges of users from the [Manage users screen](#).

An **Administrator** can change printer information, add and delete apps, manage users, and perform various other operations.

A **Standard user** can check printer information and start apps.

For information about the functions that each user can use, refer to the "[Canon Inkjet Cloud Printing Center window](#)".

If you are using MAXIFY Cloud Link from the printer, select **Multiusers mode** in the [Mng. printer screen](#) to set the printer to **Multiusers mode**. Each user can then start an app and print documents.

➤➤➤ Note

- If you have not set your own **Security code**, select **Multiusers mode** to display the **Security code** setup screen.
If you select **Cancel**, you will not be able to set **Multiusers mode**.
- If you are the **Administrator**, a confirmation screen appears asking whether you want to send an e-mail prompting standard users without a **Security code** to set up their **Security code**.
 - To send a notification e-mail is sent only to users without a **Security code** and to set **Multiusers mode**, select **OK**.

- To set **Multuser mode** without sending a notification e-mail, select **Cancel**.

■ [Troubleshooting Canon Inkjet Cloud Printing Center](#)

Troubleshooting Canon Inkjet Cloud Printing Center

- [If an app cannot be installed](#)
- [If the registered app is not in the Apps list](#)
- [If the information is not updated when you press the update button](#)
- [If you do not receive the registration e-mail](#)
- [If you cannot print](#)
- [Printing starts on its own even if you do not do anything](#)
- [If you are unable to log in correctly even after entering the correct password in iOS or Mac](#)

If an app cannot be installed

Check the country or region where the printer was purchased.

If the printer is taken outside the country or region where it was purchased, apps cannot be installed.

If You Are Using iP110 series

Check the country or region where the printer was purchased.

If you take the printer outside the country or region where you purchased it, you may not be able to install certain apps.

You can continue to use apps that are already installed, as long as the apps support the country or region you are moving to.

If the registered app is not in the Apps list

Check the display language of Canon Inkjet Cloud Printing Center.

If the display language is switched to a language that does not support an app, the app will not be displayed in the apps list but will continue to be registered.

If you switch back to the target language of the app, it will be displayed in the apps list and you will be able to start, register, or unregister the app.

If the information is not updated when you press the update button



Because the Properties screen requires network connection with this product, the information may not be reflected immediately. Please wait awhile, and then try updating the information again.

If the information is still not updated, then check that the product is connected to the Internet.

If you do not receive the registration e-mail

You may have entered a different e-mail address during the user registration of Canon Inkjet Cloud Printing Center.

If your model has color LCD monitor

On the printer's Home screen, select  **Setup** ( Various settings) ->  **Web service setup** -> **Web service connection setup** -> **IJ Cloud Printing Center setup** -> **Delete from this service** to delete the service registration.

If your model has monochrome LCD monitor



On the printer operation panel, select the **Setup** button, and then select **Web service setup** -> **Connection setup** -> **IJCloudPrintingCtr** -> **Delete from service** to delete the service registration.

If your model has no LCD monitor

Displaying Printer Information -> **IJ Cloud Printing Center setup** -> **Delete from this service** to delete the service registration.

To display printer information, go to the Online Manual home page, and see "Checking Printer Information" for your model.

After resetting the printer, repeat the user registration of Canon Inkjet Cloud Printing Center from the beginning.

If you cannot print

Check the following if you cannot print.

If your model has color LCD monitor

- Check that the printer is connected to the Internet.
- Check that the printer is connected to a LAN and the LAN environment is connected to the Internet.
- Check that no error message is displayed on the printer's LCD monitor.
- If printing does not start even after you wait awhile, go to the printer's home screen, and select



Setup (



Various settings) -> **Web service inquiry**.

If your model has monochrome LCD monitor

- Check that the printer is connected to the Internet.
- Check that the printer is connected to a LAN and the LAN environment is connected to the Internet.
- Check that no error message is displayed on the printer's LCD monitor.

- If printing does not start even after you wait awhile, go to the printer operation panel, select  **Setup**, and run **Web service inquiry**. If printing does not start, run the inquiry several times.

If your model has no LCD monitor

- Check that the printer is connected to the Internet.
- Check that the printer is connected to a LAN and the LAN environment is connected to the Internet.
- If printing does not start even after you wait awhile, first turn off the printer, and then turn it back on again.

If the problem is not resolved, use the printer driver from your computer to perform the print job and check whether the data can be printed normally on the printer.

If you still cannot print, see the troubleshooting page for your model on the Home of the Online Manual.



▶▶▶ Note

- With a wireless LAN connection, after the printer is turned on, it may take several minutes before communication is possible. Check that your printer is connected to the wireless network, and wait a while before you start printing.
- If the printer is not turned on or is not connected to the Internet, and consequently a print job is not processed within 24 hours after it was submitted, the print job is automatically canceled. If this happens, check the printer power and the Internet connection, and then re-submit the print job.

Printing starts on its own even if you do not do anything

A third party may be able to illegally use the Canon Inkjet Cloud Printing Center services.

If your model has color LCD monitor

On the printer's Home screen, select  **Setup** ( Various settings) ->  **Web service setup** -> **Web service connection setup** -> **IJ Cloud Printing Center setup** -> **Delete from this service** to delete the service registration.

If your model has monochrome LCD monitor

On the printer operation panel, select the  **Setup** button, and then select **Web service setup** -> **Connection setup** -> **IJCloudPrintingCtr** -> **Delete from service** to delete the service registration.

If your model has no LCD monitor

Displaying Printer Information -> **IJ Cloud Printing Center setup** -> **Delete from this service** to delete the service registration.

To display printer information, go to the Online Manual home page, and see "Checking Printer Information" for your model.

After resetting the printer, repeat the user registration of Canon Inkjet Cloud Printing Center from the beginning.

If you are unable to log in correctly even after entering the correct password in iOS or Mac

If you are using iOS or Mac and the password contains the ¥ or ₩ symbol, enter a backslash instead. For instructions on entering a backslash, see the OS help.

Print Easily from a Smartphone or Tablet with Canon PRINT Inkjet/SELPHY

Use the "Canon PRINT Inkjet/SELPHY" application to easily print photos saved on a smartphone or tablet (iOS or Android) wirelessly.



Canon PRINT Inkjet/SELPHY can be downloaded from App Store and Google Play.

Follow the steps below to print photos easily.

1. Download Canon PRINT Inkjet/SELPHY.

For iOS

For Android

2. Connect printer to Wi-Fi by following instructions on application screen.
3. Select photo in **Photo Print** of application, and then tap **Print**.

Printing with Windows RT

When you use Windows RT 8.1 or a later version, printing is easy because you simply connect this printer to the network.

For information about connecting to the network, see the setup URL (<http://www.canon.com/ijsetup>) for using this product from your computer, smartphone, or tablet device.

When the connection is complete, the Canon Inkjet Print Utility software, which allows you to specify detailed print settings, is downloaded automatically.

By using Canon Inkjet Print Utility, you can check the **Printer status** and specify detailed print settings. (The available functions will differ depending on your usage environment and connection method.)

Handling Paper, Ink Tanks, etc.

▶ Loading Paper

- Paper Sources
- Loading Plain Paper / Photo Paper
- Loading Envelopes

▶ Replacing Ink Tanks

- Replacing Ink Tanks
- Checking Ink Status on the LCD

Loading Paper

- ▶ **Paper Sources**
- ▶ **Loading Plain Paper / Photo Paper**
- ▶ **Loading Envelopes**

Paper Sources

Types and Sizes of Paper You Can Use

Paper can be loaded in cassette 1 (A) and in cassette 2 (B).

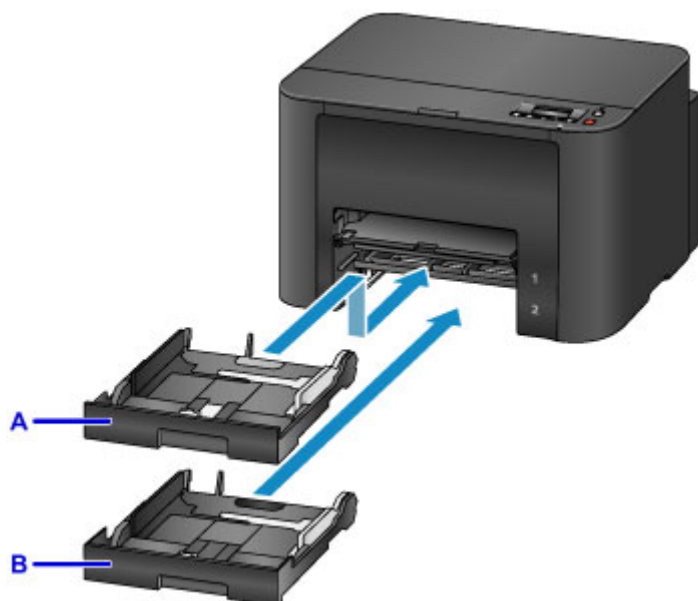

On top, cassette 1 (A) holds all sizes of paper that are compatible with the printer, such as plain paper, photo paper, and envelopes.

Below it, cassette 2 (B) holds A4, Letter, Legal, Oficio, B-Oficio, M-Oficio, Foolscap, and Legal (India)-sized plain paper.

■ [Supported Media Types](#)

To avoid running out of paper, you can load the same size of plain paper (A4, Letter, Legal, Oficio, B-Oficio, M-Oficio, Foolscap, or Legal (India)) in both cassettes and set the printer to automatically switch to the other cassette when the first one is empty.

■ [Cassette settings](#)

▶▶▶ Note

- When printing, select the correct sizes and types of paper. Incorrect page size and media type settings may cause feeding from the wrong paper source, or print quality may be affected.

For instructions on loading paper in a cassette, see these sections.

■ [Loading Plain Paper / Photo Paper](#)

■ [Loading Envelopes](#)

Adjusting the cassette to the Size of Paper Used

The cassette can be adjusted to three lengths. To extend the cassette, hold down the lock (C) as you pull the front toward you.

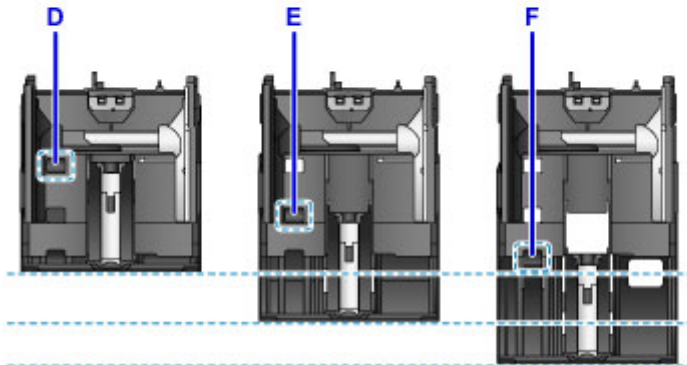
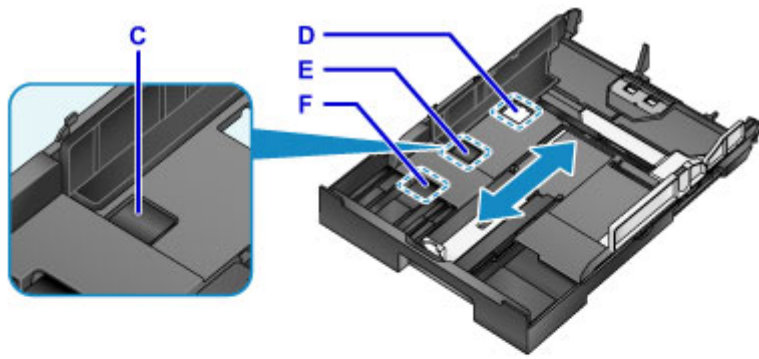

D: Lock position for stowing the cassette

Set to position D when the printer will not be used for some time, or before shipping it. In this position, the cassette is flush against the surface of the printer. Note that paper cannot be loaded in this position.

E: Lock position for A4 or Letter-sized paper or smaller

Set to position E for paper of A4 or Letter size or smaller. The cassette is not flush against the printer, but you can cover it by pulling out the paper output tray. Set the cassette to this position for normal use.

F: Lock position for paper larger than A4 or Letter size

Set to position F for paper larger than A4 size, such as Legal-sized paper. In this position, the cassette is not fully covered when you pull out the paper output tray. (By design, the cassette protrudes from the printer a little.)

Load Paper Printing-Side Down

Some paper such as photo paper has distinct top and bottom surfaces. Load this paper with the whiter or glossy side facing down.

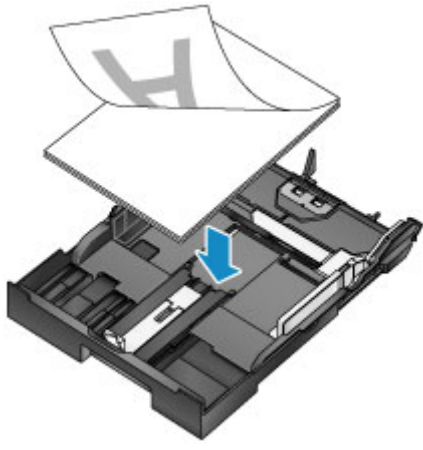

Loading Plain Paper / Photo Paper

Load paper in cassette 1 or cassette 2.

* This example demonstrates loading in cassette 1, but paper is loaded the same way in cassette 2.

►►► Important

- Paper may jam if you test printing by cutting plain paper into smaller sizes, such as 4" x 6" (10 x 15 cm) or 5" x 7" (13 x 18 cm).

►►► Note

- In cassette 1, you can load all sizes of paper that are compatible with the printer, such as plain paper, photo paper, and envelopes.
- In cassette 2, load A4, Letter, Legal, Oficio, B-Oficio, M-Oficio, Foolscap, or Legal (India)-sized plain paper.
- For details on sizes and weights of paper you can use, see [Supported Media Types](#).
- For instructions on loading envelopes, see [Loading Envelopes](#).

1. Prepare the paper.

Align the edges of the paper. If the paper is curled, flatten it.

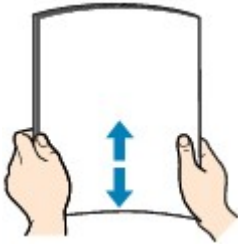

►►► Note

- Align the edges of paper neatly before loading it. Loading an uneven stack of paper may cause paper jams.
- If paper is curled, gently bend the curled corners in the opposite direction to flatten the paper.
For details on how to flatten curled paper, see "Correct curl before loading paper." [Paper Is Smudged / Printed Surface Is Scratched](#).
- Slight curling of Photo Paper Plus Semi-gloss SG-201 should not be straightened. Instead, load one sheet at a time as-is. Bending this kind of paper to flatten it may crack the surface and reduce print quality.

2. Pull out a cassette.



3. Slide the front (A) and right (B) paper guides out to make room for the paper.
4. Load the stack of paper printing-side DOWN, centered on the cassette.

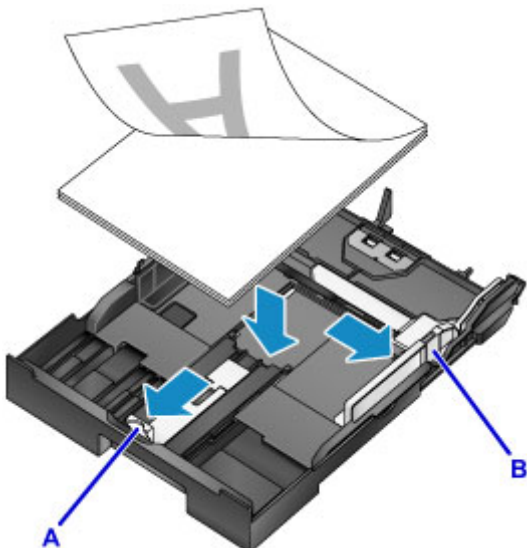

►► Important

- Always load paper in portrait orientation (C). Loading paper in landscape orientation (D) may cause paper jams.

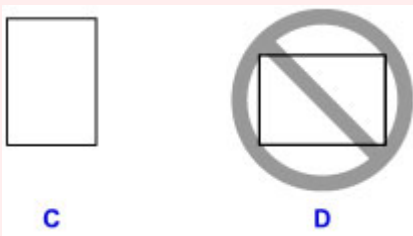

►► Note

- Some paper such as photo paper has distinct top and bottom surfaces. Load this paper with the whiter or glossy side facing down.
- Align the stack of paper with the edge of the cassette as shown.

Feeding problems may occur if the paper is touching the protrusion (E).

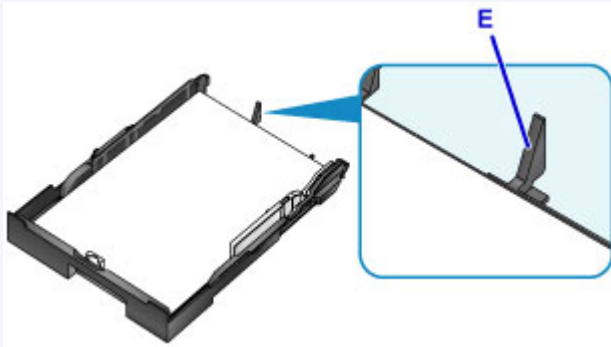

- To load paper 5" x 7" (13 x 18 cm) or smaller, lift the tab (F) on the paper guide. (Only cassette 1 can be used for paper of this size.)

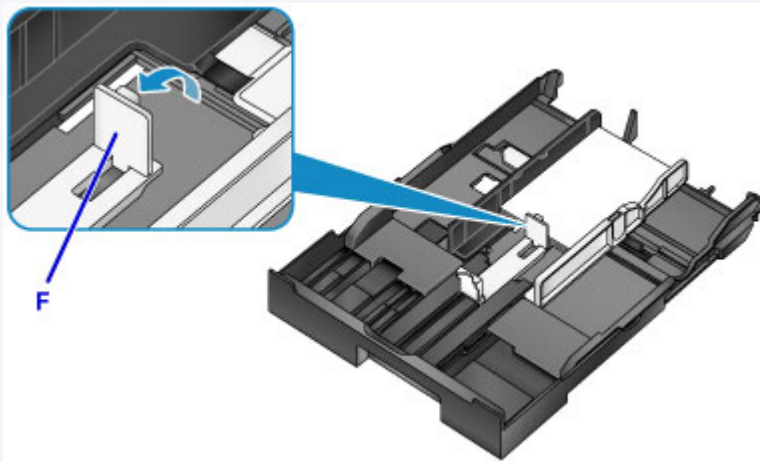

- To load paper larger than A4 size, press the lock (G) and pull the cassette all the way out.

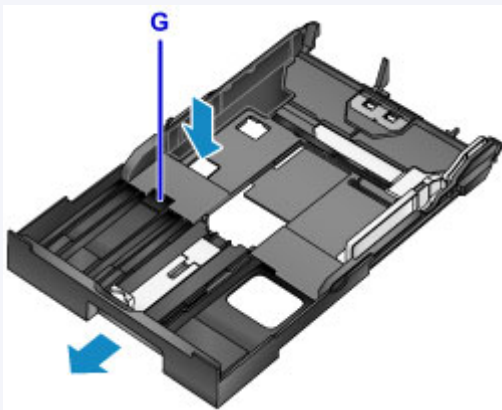

5. Align the front paper guide (A) with the stack.

The paper guide (A) clicks into place when aligned with a page size marked on the cassette.

6. Slide the right paper guide (B) to align the right and left guides with both edges of the stack.

Do not set the paper guides too firmly against the paper, which may cause feeding problems.

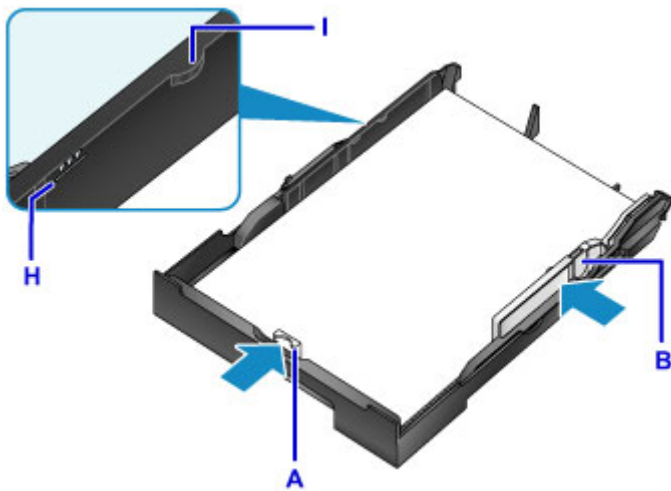

►► Note

- Do not load sheets of paper past the load limit mark (H).
- Keep the stack height below the paper guide tabs (I).

7. Insert the cassette.

Push the cassette into the printer until it stops.

After you insert the cassette, a screen for registering paper information for the cassette is displayed on the LCD.



►► Note

- Paper A4 or Letter-sized or smaller: The cassette stops at the same position as the extended paper output tray, which then covers the cassette.
- Paper larger than A4 or Letter size: The cassette protrudes past the paper output tray. Do not force the cassette into the printer any further, which may damage the printer or cassette.



8. Press the **OK** button.

Register cassette 1 paper
[OK]Next

9. Use the ◀ or ▶ button to select the size of paper in the cassette, and then press the **OK** button.

Size: ◀ *A4 ▶
Type: *PlusGlossyII

▶▶▶ **Note**

- Current page size and media type settings are marked with a *.

■ [Paper Settings](#)

10. Use the ◀ or ▶ button to select the type of paper in the cassette, and then press the **OK** button.

Size: *A4
Type: Plain paper ▶

11. Pull out the output tray extension (J) and open the paper output support (K).



»» Note

- Before printing, select the size and type of loaded paper on the print settings screen of the printer driver.

Loading Envelopes

Load envelopes in cassette 1.

Once you have set up the printer driver correctly, addresses are automatically rotated and printed to suit the envelope orientation.

▶▶▶ Important

- Do not use the following envelopes. These kinds of envelopes may become stuck or cause the printer to malfunction.
 - Envelopes with embossed or coated surfaces
 - Envelopes with a double flap
 - Envelopes with adhesive flaps that are already moistened

▶▶▶ Note

- For details on sizes and weights of paper you can use, see [Supported Media Types](#).

1. Prepare the envelopes.

- To flatten the envelopes, press down on the corners and edges.

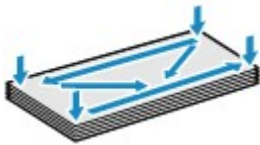

- If the envelopes are curled, hold opposite corners and gently bend them the opposite way.



- Flatten any flaps that are bent.
- Using a pen, press the leading edge in the direction of insertion to flatten the envelope.

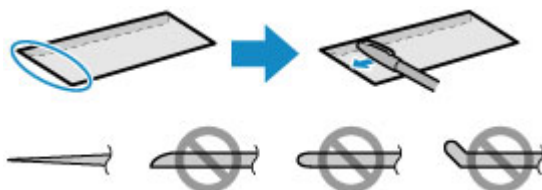

Side view of the envelope's leading edge.

▶▶▶ Important

- Envelopes that are not flat or that are loaded unevenly may become stuck. Make sure that any curled or bowed surfaces are no higher than 0.1 inch (3 mm).

2. Pull out cassette 1.



3. Slide the front (A) and right (B) paper guides out to make room for the paper.

4. Load the envelopes face-DOWN, centered in cassette 1.

The flap will face up, as shown below.

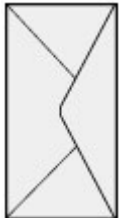

Up to 10 envelopes can be loaded at once.

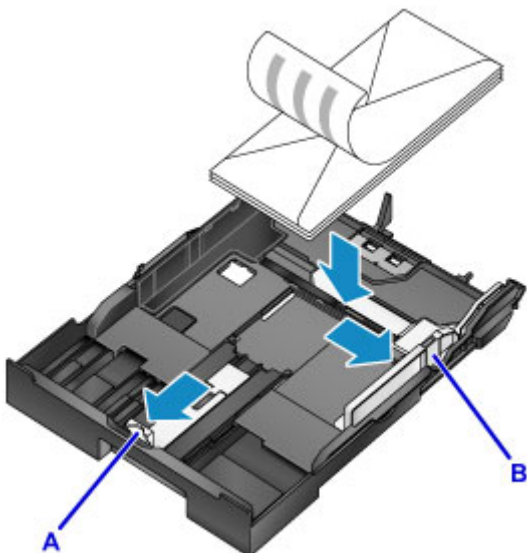

▶▶▶ Note

- Align the stack of envelopes with the edge of cassette 1 as shown.
Feeding problems may occur if the envelopes are touching the protrusion (C).

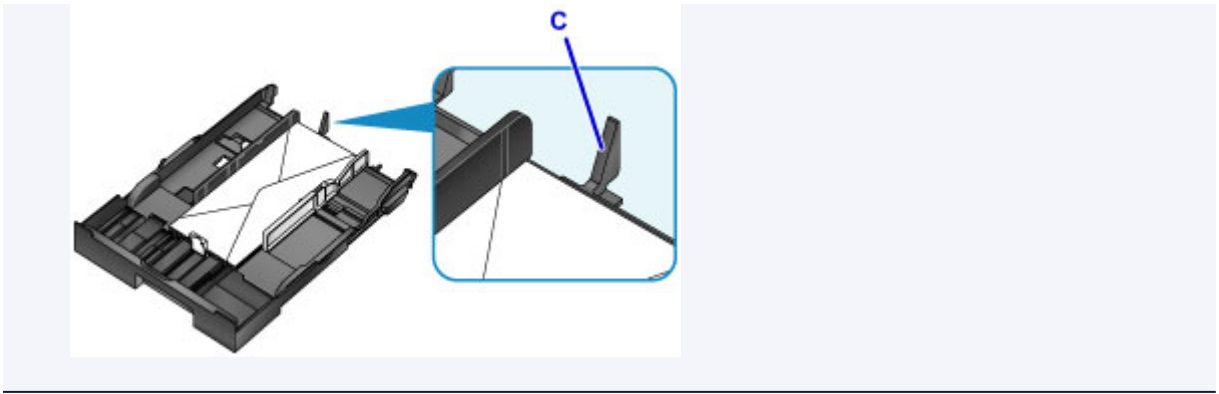

5. Align the front paper guide (A) with the edge of the envelopes.
6. Slide the right paper guide (B) to align the right and left guides with both edges of the envelopes.

Do not set the paper guides too firmly against the envelopes, which may cause feeding problems.

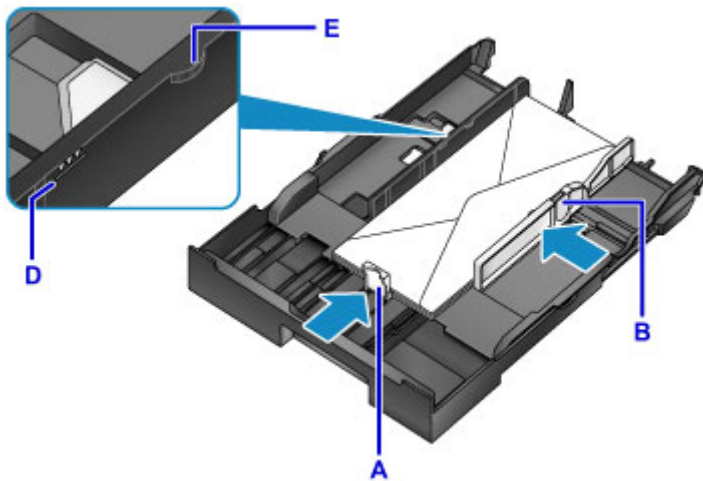

▶▶ Note

- Do not load envelopes past the load limit mark (D).
- Keep the stack height below the paper guide tabs (E).

7. Insert cassette 1.

Push cassette 1 into the printer until it stops.

After you insert the cassette, a screen for registering paper information for the cassette is displayed on the LCD.

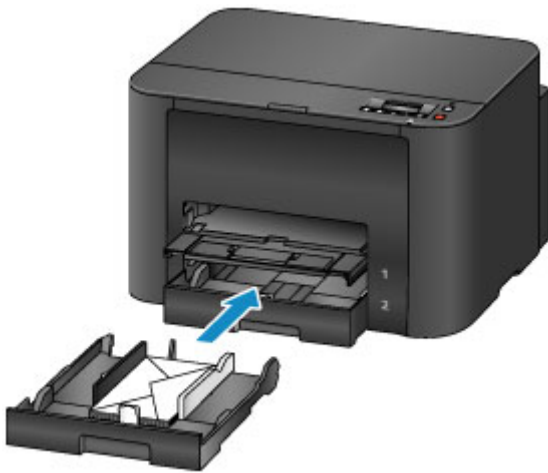

8. Press the **OK** button.

```
Register cassette 1 pape  
[OK]Next
```

9. Use the ◀ or ▶ button to select the size of envelopes in the cassette, and then press the **OK** button.

```
Size: ◀ Envelope DL ▶  
Type: *Plain paper
```

▶▶▶ Note

- Current page size and media type settings are marked with a *.

■ [Paper Settings](#)

10. Use the ◀ or ▶ button to select **Envelope**, and then press the **OK** button.

```
Size: Envelope DL  
Type: ◀ Envelope ▶
```

11. Pull out the output tray extension (F), and then open the paper output support (G).



▶▶ Note

- Before printing, select the size and type of loaded envelopes on the print settings screen of the printer driver.

Replacing Ink Tanks

- ▶ [Replacing Ink Tanks](#)
- ▶ [Checking Ink Status on the LCD](#)

Replacing Ink Tanks

In the case of warnings or errors caused by low ink levels, messages appear on the LCD to notify you. Respond to the message as needed.

■ [Message Appears](#)

▶▶▶ Note

- If printing is faint or affected by white streaks even when there is enough ink, see [Maintenance Procedure](#).
- For precautionary notes on handling ink tanks, see [Notes on ink tanks](#).

Steps to Replace ink tanks

When needed, replace ink tanks as follows.

1. After confirming that the printer is on, open the front cover.

The ink tanks you can replace are identified on the LCD, and the print head holder (A) moves into position for replacement of those ink tanks.

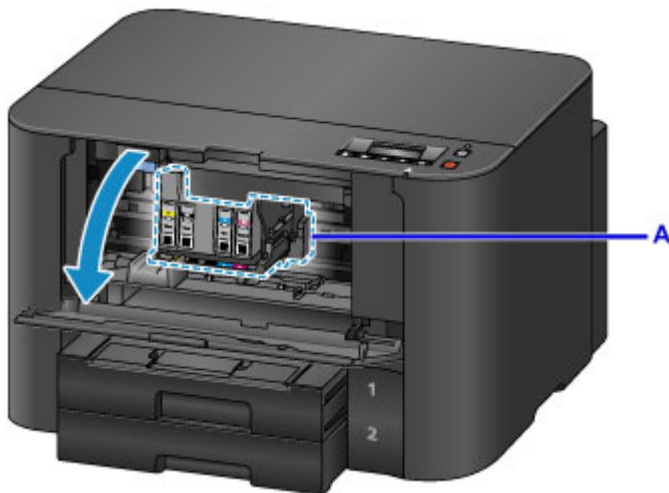

⚠ Caution

- Do not stop the moving print head holder or force it to a different position. Do not touch the print head holder until it stops moving.

▶▶▶ Important

- Do not remove an ink tank until a new one is prepared to be installed.
 - Once you remove an ink tank, the machine will not operate until a new one is installed.
 - Once you remove an ink tank, the machine will not operate even if the removed ink tank is just reinstalled.
- The ink tanks in other positions cannot be replaced. Forcing them out may damage the printer or cause malfunction.
- Do not touch metallic parts or other areas inside the printer.

- If you leave the front cover open for more than 60 minutes, the print head holder will move to the right. In this case, close the front cover and open it again.

▶▶▶ Note

- If a warning about ink tank replacement appears, check the message and press the **OK** button.

2. Once the ink tank for replacement is identified on the LCD, push up the ink tank eject lever (B).

The ink tank is ejected.

To replace another ink tank, press the **OK** button to select **[OK]Next** and display the screen for the next ink tank to replace.

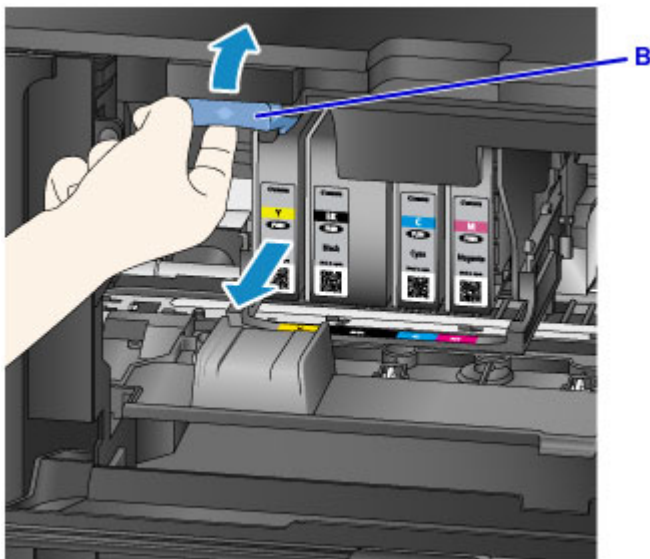

▶▶▶ Important

- Place the removed ink tank into a plastic bag immediately after removing from the printer. Otherwise, ink residue may stain your clothes or the surrounding area.
- Do not touch parts other than ink tanks.
- Follow local regulations when discarding used ink tanks.
- Handle ink tanks carefully. Do not drop them or press hard on them.

3. Remove the ink tank from the package.

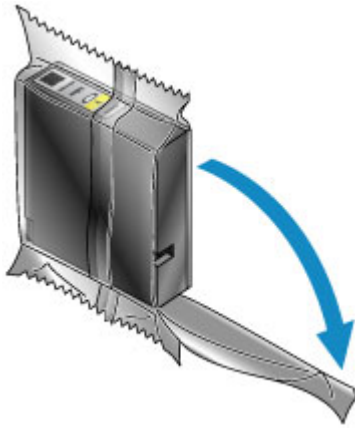

»» Important

- Do not touch the contact (C) or interface (D) of the ink tank.

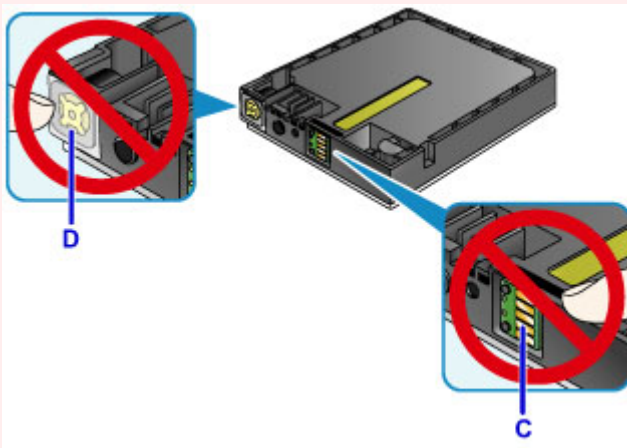

4. Insert the new ink tank, aligning it with the installation guide (E) on the printer.

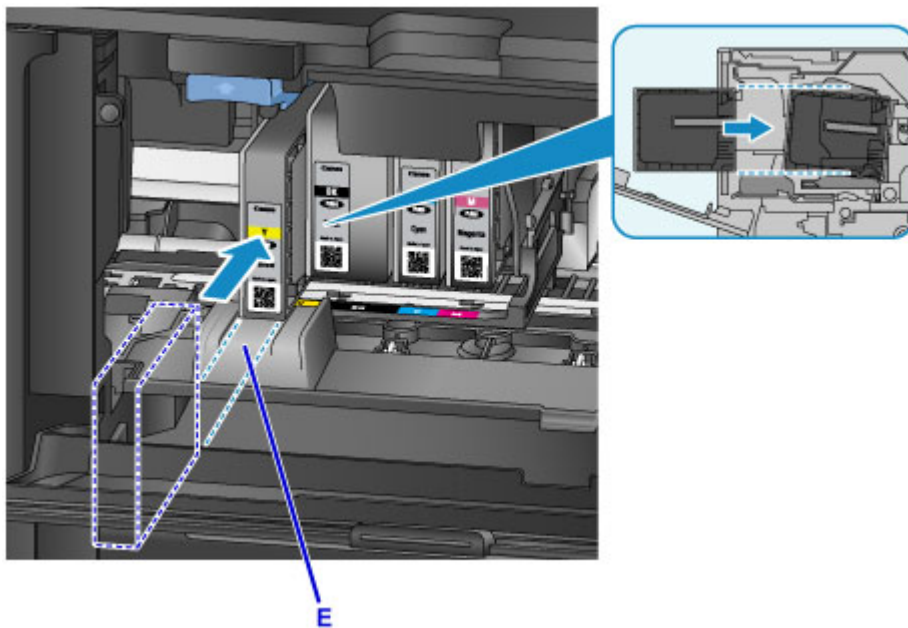

»» Important

- The ink tank will not fit in the wrong position. Check the label under the installation position, and install the ink tank in the correct position.

5. Push the ink tank in firmly until it clicks into place.

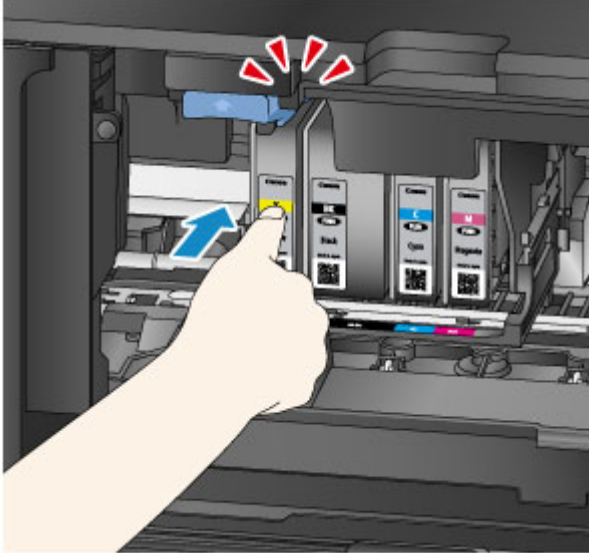

6. Press the **OK** button to select **[OK]Exit**.

If **[OK]Next** is displayed, another ink tank can be replaced.

To replace the next ink tank, press the **OK** button and repeat this procedure from step 2.

To exit ink tank replacement, press the **OK** button until **[OK]Exit** is displayed.

The print head holder moves to the standby position. The ink tanks cannot be removed from this position.

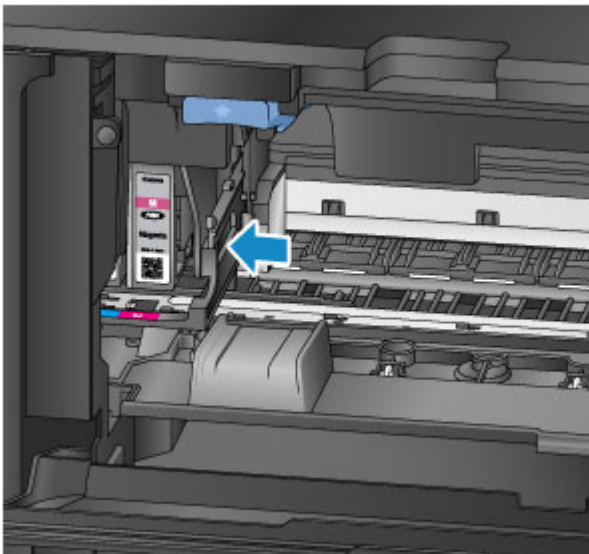

»» Important

- Printing is not possible without a complete set of ink tanks installed. Install all ink tanks.

- Installed ink tanks cannot be removed until a replacement message appears.

7. Close the front cover.



After ink tank replacement, the printer starts mixing the ink automatically. Wait until this noise stops. (Mixing takes 1–2 minutes.)

▶▶▶ Note

- Respond to any error messages as needed.
 - [Message Appears](#)
- If the print head is out of alignment, as when parallel lines are not printed parallel, [align the print head](#).
- The printer may make a noise during these operations, but this does not indicate a problem.

Notes on ink tanks

▶▶▶ Important

- Install replacement ink tanks promptly. Do not leave the printer without ink tanks installed.
- Replace empty ink tanks with new ones. Installing used ink tanks may clog the nozzles. Used ink tanks may also prevent correct notification of the ink tank replacement timing.
- Do not remove installed ink tanks and leave them outside the printer. In this state, ink tanks will dry out, which may prevent correct operation when they are reinstalled. To maintain optimal print quality, use up ink tanks within six months after you install them.

▶▶▶ Note

- Color ink may be consumed even when printing black-and-white originals, or when black-and-white printing is specified.

All colors of ink are also consumed during standard and deep print head cleaning to maintain performance. When ink tanks run out of ink, promptly replace them with new ones.

■ [Ink Tips](#)

Checking Ink Status on the LCD

You can also check ink status on the LCD.

A symbol appears in area A in case of any messages about the remaining ink level.

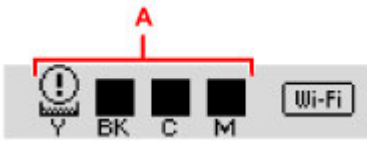

Example: ⓘ

Ink tank is running low. Prepare a new ink tank.

▶▶▶ Note

- Ink levels on this screen are estimates.
- To print the ink tank model number, select **Print ink number** in **Ink information** on the **Setup menu** screen.
- You can also check ink status from a computer.
 - [Checking the Ink Status from Your Computer](#) (Windows)
 - [Checking the Ink Status from Your Computer](#) (Mac OS)

Maintenance

- ▶ **If Printing Is Faint or Uneven**
- ▶ **Performing Maintenance Functions from Your Computer (Windows)**
- ▶ **Performing Maintenance Functions from Your Computer (Mac OS)**
- ▶ **Cleaning**

If Printing Is Faint or Uneven

- **Maintenance Procedure**
- **Printing the Nozzle Check Pattern**
- **Examining the Nozzle Check Pattern**
- **Cleaning the Print Head**
- **Deep Print Head Cleaning**
- **Aligning the Print Head**

Maintenance Procedure

Follow these steps to restore print quality if printing becomes faint or uneven, colors are incorrect, or printing results are not as expected (as when parallel lines are not printed parallel).

►►► Note

- Increasing the print quality in the printer driver may give better results.
 - [Changing the Print Quality and Correcting Image Data](#) (Windows)
 - [Changing the Print Quality and Correcting Image Data](#) (Mac OS)

To Correct Faint or Uneven Printing:

|| Step1 Print the nozzle check pattern.

From your printer

- [Printing the Nozzle Check Pattern](#)

From your computer

- [Printing a Nozzle Check Pattern](#) (Windows)
- [Printing a Nozzle Check Pattern](#) (Mac OS)

|| Step2 [Examine the nozzle check pattern.](#)

Some missing lines or horizontal white streaks in the pattern:



|| Step3 Clean the print head.

From your printer

- [Cleaning the Print Head](#)

From your computer

- [Cleaning the Print Heads](#) (Windows)
- [Cleaning the Print Heads](#) (Mac OS)

After cleaning the print head, print and examine the nozzle check pattern again: ➡ [Step1](#)

Problem not resolved after you perform from step 1 to step 3 twice:



|| Step4 Perform deep print head cleaning.

From your printer

- [Deep Print Head Cleaning](#)

From your computer

- [Cleaning the Print Heads](#) (Windows)
- [Cleaning the Print Heads](#) (Mac OS)

▶▶▶ Note

- If printing problems remain even after step 4, turn the printer off, wait at least 24 hours, and perform deep print head cleaning again.

If the problem is still not resolved, the print head may be damaged. Contact the service center.

To Correct Misalignment:

|| Step | Align the print head.

From your printer

- [Aligning the Print Head](#)

From your computer

- [Aligning the Print Head Position](#) (Windows)
- [Aligning the Print Head Position](#) (Mac OS)

Printing the Nozzle Check Pattern

Print the nozzle check pattern to determine whether ink is being ejected correctly from the print head nozzles.

▶▶▶ Note

- If ink runs out as the nozzle check pattern is printed, an error message appears on the LCD.

■ [Message Appears](#)

What you will need: one sheet of A4 or Letter-sized plain paper

1. Make sure the printer is on.
2. Load a sheet of A4 or Letter-sized plain paper in cassette 1.

After you insert the cassette, a screen for registering paper information is displayed on the LCD. Select **A4** or **Letter** in **Size:** and **Plain paper** in **Type:**, and then press the **OK** button.



▶▶▶ Important

- Nozzle check patterns cannot be printed from cassette 2. Load paper in cassette 1.

3. Pull out the output tray extension and open the paper output support.
4. Press the **Setup** button, use the ◀ or ▶ button to select **Maintenance**, and then press the **OK** button.

■ [LCD and Operation Panel](#)

5. Use the ◀ or ▶ button to select **Nozzle check**, and then press the **OK** button.

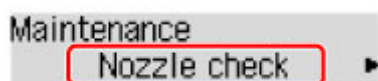

The nozzle check pattern is now printed.

6. [Examine the nozzle check pattern.](#)

Examining the Nozzle Check Pattern

Examine the nozzle check pattern and clean the print head if necessary.

1. Check for any missing lines in pattern A or horizontal white streaks in pattern B.

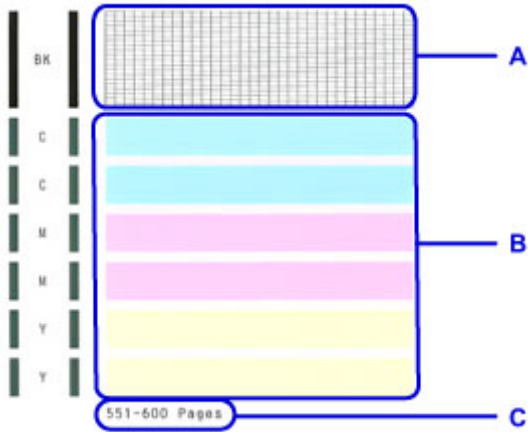

C: Number of pages printed to date

If pattern A has missing lines:

[The print head](#) must be cleaned.



D: No missing lines

E: Missing lines

If pattern B has horizontal white streaks:

[The print head](#) must be cleaned.



F: No horizontal white streaks

G: Horizontal white streaks

►► Note

- On the nozzle check printout, the record of total pages printed is indicated in increments of 50 pages.

Cleaning the Print Head

Clean the print head if the nozzle check pattern has missing lines or horizontal white streaks. Cleaning unclogs nozzles and restores the print head to a better condition. However, because print head cleaning consumes ink, this operation is advisable only when necessary.

▶▶▶ Note

- Cleaning can also be performed from a computer. When using a computer, you can also select the ink group for cleaning.
 - [Cleaning the Print Heads](#) (Windows)
 - [Cleaning the Print Heads](#) (Mac OS)
- Cleaning from the operation panel cleans all print head colors.

1. Make sure the printer is on.
2. Press the **Setup** button, use the ◀ or ▶ button to select **Maintenance**, and then press the **OK** button.

■ [LCD and Operation Panel](#)

3. Use the ◀ or ▶ button to select **Cleaning**, and then press the **OK** button.

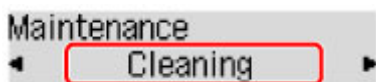

The printer now starts cleaning the print head.

Do not perform any other operations until print head cleaning is finished. Cleaning will take about 2 minutes.

4. Check the condition of the print head.

To check the condition of the print head, [print the nozzle check pattern](#).

▶▶▶ Note

- If printing problems remain even after you clean the print head twice, [perform deep print head cleaning](#).

Deep Print Head Cleaning

If standard print head cleaning does not improve print quality, try deep print head cleaning. However, because deep print head cleaning consumes more ink, this operation is advisable only when necessary.

»» Note

- Deep print head cleaning can also be performed from a computer. When using a computer, you can also select the ink group for deep cleaning.
 - [Cleaning the Print Heads](#) (Windows)
 - [Cleaning the Print Heads](#) (Mac OS)
- Deep print head cleaning from the operation panel cleans all print head colors.

1. Make sure the printer is on.

2. Press the **Setup** button, use the ◀ or ▶ button to select **Maintenance**, and then press the **OK** button.

■ [LCD and Operation Panel](#)

3. Use the ◀ or ▶ button to select **Deep cleaning**, and then press the **OK** button.

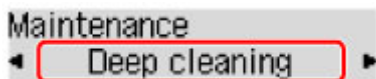

Deep print head cleaning now begins.

Do not perform any other operations until deep print head cleaning is finished. Cleaning will take 2–3 minutes.

4. Check the condition of the print head.

To check the condition of the print head, [print the nozzle check pattern](#).

If printing problems remain, turn the printer off, wait at least 24 hours, and perform deep print head cleaning again.

If the problem is still not resolved, the print head may be damaged. Contact the service center.

Aligning the Print Head

If printed images seem distorted, as when parallel lines are not printed parallel, align the print head.

▶▶▶ Note

- If ink runs out as the print head alignment sheet is printed, an error message appears on the LCD.
■ [Message Appears](#)

What you will need: one sheet of A4 or Letter-sized plain paper (recycled paper is acceptable)*

* Use white paper that is clean on both sides.

1. Make sure the printer is on.
2. Load a sheet of A4 or Letter-sized plain paper in cassette 1.

After you insert the cassette, a screen for registering paper information is displayed on the LCD. Select **A4** or **Letter** in **Size:** and **Plain paper** in **Type:**, and then press the **OK** button.



▶▶▶ Important

- Print head alignment cannot be performed from cassette 2. Load paper in cassette 1.

3. Pull out the output tray extension and open the paper output support.
4. Press the **Setup** button, use the ◀ or ▶ button to select **Maintenance**, and then press the **OK** button.
■ [LCD and Operation Panel](#)
5. Use the ◀ or ▶ button to select **Head alignment**, and then press the **OK** button.

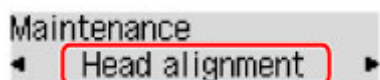

The print head alignment sheet is printed, and the print head is aligned automatically.

This process takes 3–4 minutes.

▶▶▶ Note

- If automatic print head alignment fails, an error message appears.
■ [Message Appears](#)
- If printing is still unsatisfactory after automatic print head alignment, align the print head manually from a computer.
■ [Aligning the Print Head Position Manually](#) (Windows)

Performing Maintenance Functions from Your Computer (Windows)

- ▶ **Cleaning the Print Heads**
- ▶ **Aligning the Print Head Position**
- ▶ **Printing a Nozzle Check Pattern**

Cleaning the Print Heads

The print head cleaning function allows you to clear up clogged print head nozzle. Perform print head cleaning if printing is faint or a specific color fails to print, even though there is enough ink.

The procedure for cleaning the print head is as follows:



Cleaning

1. Open the [printer driver setup window](#)

2. Click **Cleaning** on the **Maintenance** tab

When the **Print Head Cleaning** dialog box opens, select the ink group for which cleaning is to be performed.

Click **Initial Check Items** to display the items you need to check before performing cleaning.

3. Execute cleaning

Make sure that the printer is on and then click **Execute**.

Print head cleaning starts.

4. Complete cleaning

The **Nozzle Check** dialog box opens after the confirmation message.

5. Check the results

To check whether the print quality has improved, click **Print Check Pattern**. To cancel the check process, click **Cancel**.

If cleaning the head once does not resolve the print head problem, clean it once more.

Important

- **Cleaning** consumes a small amount of ink.
Cleaning the print head frequently will rapidly deplete your printer's ink supply. Consequently, perform cleaning only when necessary.



Deep Cleaning

Deep Cleaning is more thorough than cleaning. Perform deep cleaning when two **Cleaning** attempts do not resolve the print head problem.

1. Open the [printer driver setup window](#)

2. Click **Deep Cleaning** on the **Maintenance** tab

When the **Deep Cleaning** dialog box opens, select the ink group for which deep cleaning is to be performed.

Click **Initial Check Items** to display the items you need to check before performing deep cleaning.

3. Execute deep cleaning

Make sure that the printer is on and then click **Execute**.

Click **OK** when the confirmation message appears.

Print head deep cleaning starts.

4. Complete deep cleaning

The **Nozzle Check** dialog box opens after the confirmation message.

5. Check the results

To check whether the print quality has improved, click **Print Check Pattern**. To cancel the check process, click **Cancel**.

►► Important

- **Deep Cleaning** consumes a larger amount of ink than **Cleaning**.
Cleaning the print head frequently will rapidly deplete your printer's ink supply. Consequently, perform cleaning only when necessary.

►► Note

- If there is no sign of improvement after **Deep Cleaning**, turn off the printer, wait 24 hours, and then perform **Deep Cleaning** again. If there is still no sign of improvement, the ink may have run out or the print head may be worn. For details on the remedial action to be taken, see "No Ink Comes Out."

Related Topic

- [Printing a Nozzle Check Pattern](#)

Aligning the Print Head Position

Print head alignment corrects the installation positions of the print head and improves deviated colors and lines.

This printer supports two head alignment methods: automatic head alignment and manual head alignment. Normally, the printer is set for automatic head alignment.

If the printing results of automatic print head alignment are not satisfactory, [perform manual head alignment](#).

The procedure for performing automatic print head alignment is as follows:



Print Head Alignment

1. Open the [printer driver setup window](#)
2. Click **Print Head Alignment** on the **Maintenance** tab

The **Start Print Head Alignment** dialog box opens.

3. Load paper in the printer

Load one sheet of A4 size or Letter size plain paper into the cassette 1.

▶▶▶ Important

- The cassette 2 is not available for the print head alignment procedure. Be sure to load paper in the cassette 1.

▶▶▶ Note

- The number of sheets to be used differs when you select the manual head alignment.

4. Execute head alignment

Make sure that the printer is on and click **Align Print Head**.

Follow the instruction in the message.

▶▶▶ Important

- Do not open the front cover while printing is in progress.

▶▶▶ Note

- Wait until printing ends before performing other operations. Printing takes about 3 to 4 minutes to complete.

▶▶▶ Note

- To print and check the current setting, open the **Start Print Head Alignment** dialog box, and click **Print Alignment Value**.

Aligning the Print Head Position Manually

Print head alignment corrects the installation positions of the print head and improves deviated colors and lines.

This printer supports two head alignment methods: [automatic head alignment](#) and manual head alignment. Normally, the printer is set for automatic head alignment.

If the printing results of automatic print head alignment are not satisfactory, perform manual head alignment.

The procedure for performing manual print head alignment is as follows:



Print Head Alignment

1. Open the [printer driver setup window](#)
2. Click **Custom Settings** on the **Maintenance** tab

The **Custom Settings** dialog box opens.

▶▶▶ Note

- If the printer is off or if communication between the printer and the computer is disabled, an error message may appear because the computer cannot collect the printer status. If this happens, click **OK** to display the most recent settings specified on your computer.

3. Switch head alignment to manual
4. Apply the settings
5. Click **Print Head Alignment** on the **Maintenance** tab

Check the **Align heads manually** check box.

Click **OK** and when the confirmation message appears, click **OK**.

The **Start Print Head Alignment** dialog box opens.

6. Load paper in the printer
- Load two sheets of A4 size or Letter size plain paper into the cassette 1.

▶▶▶ Important

- The cassette 2 is not available for the print head alignment procedure. Be sure to load paper in the cassette 1.

7. Execute head alignment

Make sure that the printer is on and click **Align Print Head**.

Follow the instruction in the message.

Important

- Do not open the front cover while printing is in progress.

8. Check the printed pattern

Enter the numbers of the patterns with the least noticeable streaks in the associated boxes.

Even if the patterns with the least noticeable streaks are clicked in the preview window, their numbers are automatically entered in the associated boxes.

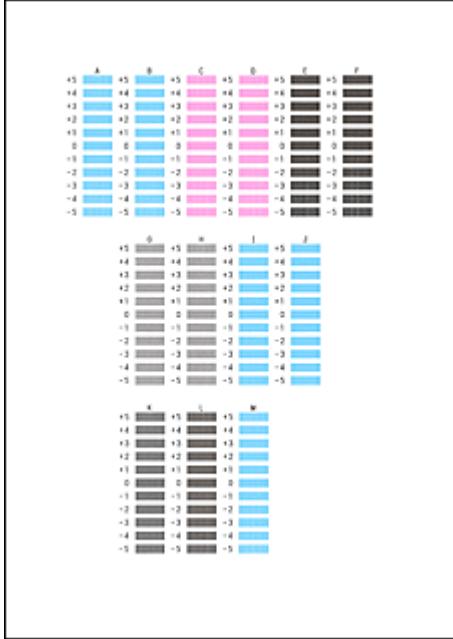

When you have entered all the necessary values, click **OK**.

Note

- If it is difficult to pick the best pattern, pick the setting that produces the least noticeable vertical streaks.



(A)



(B)

(A) Least noticeable vertical streaks

(B) Most noticeable vertical streaks

9. Confirm the displayed message and click **OK**

The second pattern is printed.

Important

- Do not open the front cover while printing is in progress.

10. Check the printed pattern

Enter the numbers of the patterns with the least noticeable stripes or streaks in the associated boxes. Even if the patterns with the least noticeable stripes or streaks are clicked in the preview window, their numbers are automatically entered in the associated boxes.

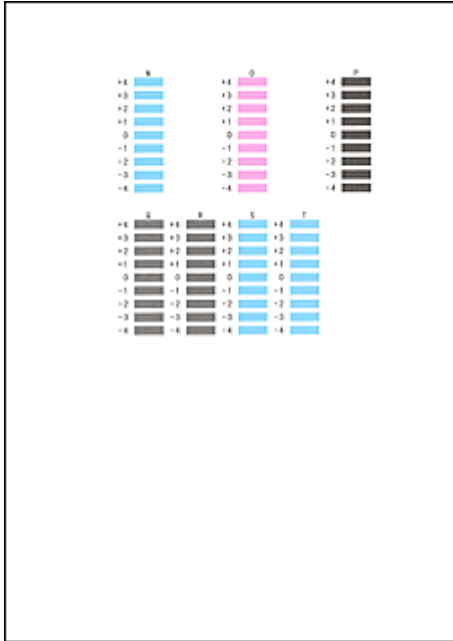

When you have entered all the necessary values, click **OK**.

►► Note

- If it is difficult to pick the best pattern, pick the setting that produces the least noticeable horizontal stripes.



(A)



(B)

(A) Least noticeable horizontal stripes

(B) Most noticeable horizontal stripes

- If it is difficult to pick the best pattern, pick the setting that produces the least noticeable vertical streaks.



(A)



(B)

(A) Least noticeable vertical streaks

(B) Most noticeable vertical streaks

►► Note

- To print and check the current setting, open the **Start Print Head Alignment** dialog box, and click **Print Alignment Value**.

Printing a Nozzle Check Pattern

The nozzle check function allows you to check whether the print head is working properly by printing a nozzle check pattern. Print the pattern if printing becomes faint, or if a specific color fails to print.

The procedure for printing a nozzle check pattern is as follows:



Nozzle Check

1. Open the [printer driver setup window](#)
2. Click **Nozzle Check** on the **Maintenance** tab

The **Nozzle Check** dialog box opens.

Click **Initial Check Items** to display the items that you need to check before printing the nozzle check pattern.

3. Load paper in the printer

Load one sheet of A4 size or Letter size plain paper into the cassette 1.

▶▶ Important

- The cassette 2 is not available for the nozzle check pattern printing. Be sure to load paper in the cassette 1.

4. Print a nozzle check pattern

Make sure that the printer is on and click **Print Check Pattern**.

Printing of the nozzle check pattern begins.

Click **OK** when the confirmation message appears.

The **Pattern Check** dialog box opens.

5. Check the print result

Check the print result. If the print result is normal, click **Exit**.

If the print result is smudged or if there are any unprinted sections, click **Cleaning** to clean the print head.

Related Topic

- [Cleaning the Print Heads](#)

Cleaning

- ▶ **Cleaning Exterior Surfaces**
- ▶ **Cleaning Paper Feed Rollers**
- ▶ **Cleaning Inside the Printer (Bottom Plate Cleaning)**
- ▶ **Cleaning Cassette Pads**

Cleaning Exterior Surfaces

Using a soft, dry cloth such as an eyeglass cloth, gently wipe the surfaces clean. Smooth out any wrinkles in the cloth before you begin.

»» Important

- Before cleaning the printer, turn it off and unplug it.
- To avoid scratching surfaces, do not clean with tissue paper, paper towels, or rough-textured cloth. Additionally, paper dust or fibers may remain in the printer and clog the print head or affect printing quality.
- Never clean the printer with detergent or volatile chemicals such as thinner, benzene, or acetone, which may cause malfunction or damage surfaces.

Cleaning Paper Feed Rollers

Dusty or dirty paper feed rollers may prevent correct feeding.

In this case, clean the paper feed rollers. However, because cleaning causes roller wear, perform cleaning only when necessary.

What you will need: three sheets of A4 or Letter-sized plain paper

1. Make sure the printer is on.
2. Press the **Setup** button, use the ◀ or ▶ button to select **Maintenance**, and then press the **OK** button.

■ [LCD and Operation Panel](#)

3. Use the ◀ or ▶ button to select **Roller cleaning**, and then press the **OK** button.

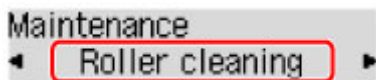

4. Remove any paper from the cassettes.

▶▶▶ Note

- If a message appears after you insert the cassette, press the **OK** button.

5. Use the ◀ or ▶ button to select the paper source to clean (**Cassette 1** or **Cassette 2**), and then press the **OK** button.

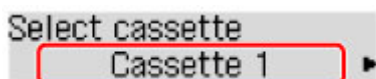

The paper feed rollers rotate as they are cleaned without paper.

6. After confirming that the paper feed rollers have stopped rotating, load three sheets of A4 or Letter-sized plain paper in the paper source selected in step 5.

After you insert the cassette, a screen for registering paper information is displayed on the LCD. Select **A4** or **Letter** in **Size:** and **Plain paper** in **Type:**, and then press the **OK** button.



7. Pull out the output tray extension and open the paper output support.
8. Press the **OK** button again.

Cleaning begins again. Once the paper is ejected, cleaning is finished.

9. Press the **Back** button to exit.

If the problem remains after you clean the paper feed rollers, contact the service center.

Cleaning Inside the Printer (Bottom Plate Cleaning)

Remove stains inside the printer as follows. Clean this way regularly, because any dust or excess ink in the printer may get on your printouts.

What you will need: one sheet of A4 or Letter-sized plain paper*

* Use a new sheet of paper.

1. After confirming that the printer is on, remove any paper from cassette 1.
2. Fold a single sheet of A4 or Letter-sized plain paper in half widthwise, and then unfold it.
3. Fold one side in half again (aligning the edge of the sheet with the center crease), and then unfold the paper.

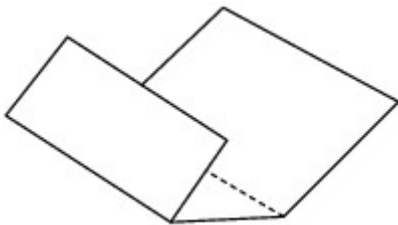

4. Load only this sheet in cassette 1, with the ridges of the creases facing up and the edge of the uncreased half facing away from you.

After you insert the cassette, a screen for registering paper information is displayed on the LCD. Select **A4** or **Letter** in **Size:** and **Plain paper** in **Type:**, and then press the **OK** button.



▶▶▶ Important

- Bottom Plate Cleaning cannot be performed from cassette 2. Load paper in cassette 1.



5. Pull out the output tray extension and open the paper output support.
6. Press the **Setup** button, use the ◀ or ▶ button to select **Maintenance**, and then press the **OK** button.

■ [LCD and Operation Panel](#)

7. Use the ◀ or ▶ button to select **Bottom cleaning**, and then press the **OK** button.

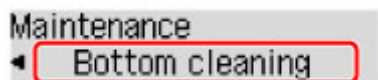

The paper now cleans inside the printer as it passes through.

Check the ridges of the ejected paper. If they are smudged with ink, perform Bottom Plate Cleaning again.

▶▶▶ Note

- When repeating Bottom Plate Cleaning, use a new sheet of paper.

If the problem remains after repeated cleaning, protrusions inside the printer may be stained. Carefully wipe off any ink on the protrusions using a cotton swab or the like.

▶▶▶ Important

- Before cleaning the printer, turn it off and unplug it.

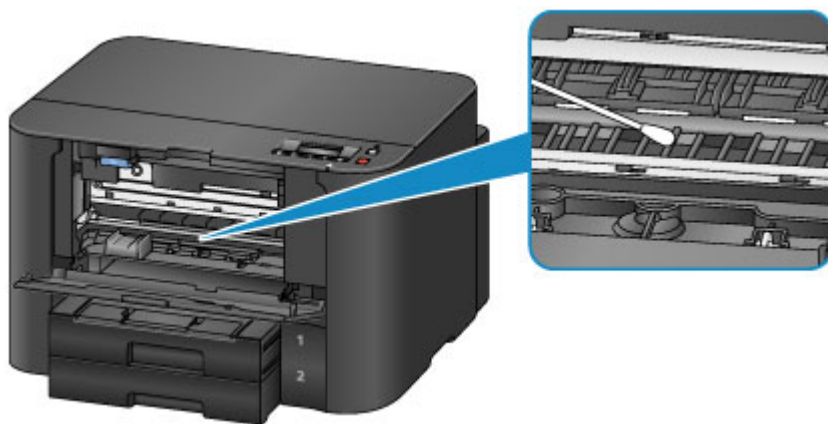

Cleaning Cassette Pads

If the pad in a cassette becomes dirty or covered with paper dust, multiple sheets of paper may be ejected at once. Clean cassette pads as follows.

What you will need: cotton swab

1. Pull out cassette 1 or cassette 2 and remove the paper.
2. Use a moistened cotton swab to wipe away any dirt or debris on the pad (A).

▶▶▶ Important

- After cleaning, allow the pad to dry completely.

Example of cleaning cassette 1:

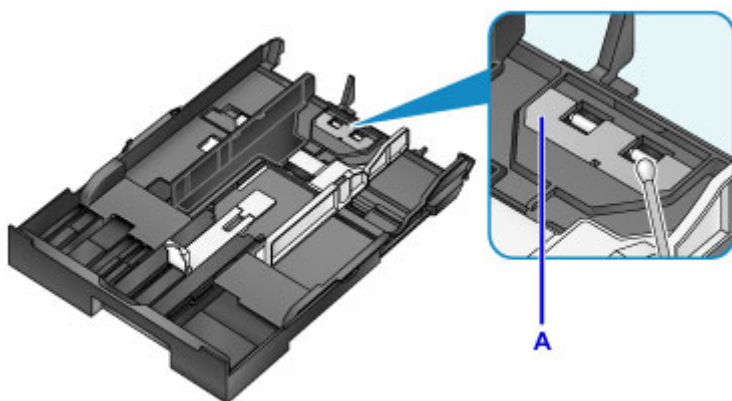

3. Reload the paper and insert the cassette.

▶▶▶ Note

- If a message appears after you insert the cassette, press the **OK** button.

If the problem is not resolved, contact the service center.

Overview

▶ **Safety**

- Safety Precautions
- Regulatory Information
- WEEE (EU & EEA)

▶ **Main Components and Their Use**

- Main Components
- Power Supply
- LCD and Operation Panel

▶ **Changing Settings**

- Changing Printer Settings from Your Computer (Windows)
- Changing Printer Settings from Your Computer (Mac OS)
- Changing Settings from Operation Panel
- Changing Printer's Setting Using Web Browser

▶ **Network Connection**

- Network Connection Tips

▶ **Network Settings (IJ Network Device Setup Utility) (Windows)**

- IJ Network Device Setup Utility
- Starting Up IJ Network Device Setup Utility
- IJ Network Device Setup Utility Screen
- Performing Network Settings
- Checking Network Status
- IJ Network Device Setup Utility Menus
- Other Network Information

▶ **Network Communication (Mac OS)**

- Checking and Changing Network Settings
- Network Communication Tips

▶ **Ensuring Optimal Printing Results**

- Ink Tips
- Printing Tips
- Check Paper Settings Before Printing
- Set Cassette Paper Information After Loading Paper
- Canceling Print Jobs
- Keeping Print Quality High
- Transporting Your Printer

▶ **Legal Restrictions on Printing**

▶ **Specifications**

Safety

- ▶ **Safety Precautions**
- ▶ **Regulatory Information**
- ▶ **WEEE (EU&EEA)**

Safety Precautions

Choosing a location

- Do not install the printer in a location that is unstable or subject to excessive vibration.
- Do not install the printer in locations that are very humid or dusty, in direct sunlight, outdoors, or close to a heating source.
To avoid the risk of fire or electric shocks, use the printer under the operating environment specified in the [Specifications](#).
- Do not place the printer on a thick rug or carpet.
- Place the printer with its back in a location that is more than 2 inches (5 cm) away from the wall.

Power Supply

- Ensure that the area around the power outlet is kept clear at all times so you can easily unplug the power cord if necessary.
- Never remove the plug by pulling on the cord.
Pulling the cord may damage the power cord, leading to possible fire or electrical shock.
- Do not use an extension lead/cord.

Working Around the Printer

- Never put your hands or fingers in the printer while it is printing.
- When moving the printer, carry the printer at both ends. In case the printer weighs more than 14 kg, it is recommended to have two people lifting the printer. Accidental dropping of the printer causes injury. For the printer's weight, refer to the [Specifications](#).
- Do not place any object on the printer. Especially do not place metal objects (paper clips, staples, etc.) or containers of flammable solvents (alcohol, thinners, etc.) on top of the printer.
- Do not transport or use the printer on a slant, vertically or upside-down, as the ink may leak and damage the printer.

Print Heads/Ink Tanks/FINE Cartridges

- Keep ink tanks out of the reach of children. In case ink is accidentally licked or swallowed, rinse out mouth or give one or two glasses of water to drink. If irritation or discomfort occurs, obtain medical advice immediately.
- In case ink gets in contact with eyes, rinse with water immediately. In case ink gets in contact with skin, wash with soap and water immediately. If irritation to eyes or skin persists, obtain medical advice immediately.
- Never touch the electrical contacts on a print head or FINE cartridges after printing.
The metal parts may be very hot and could cause burns.
- Do not throw ink tanks and FINE cartridges into fire.
- Do not attempt to disassemble or modify the print head, ink tanks, and FINE cartridges.

Regulatory Information

Users in the U.S.A.

FCC Notice (U.S.A. Only)

For 120V, 60Hz model

Model Number: K10433 (Contains FCC Approved WLAN Module K30365)

This device complies with Part 15 of the FCC Rules. Operation is subject to the following two conditions: (1) This device may not cause harmful interference, and (2) this device must accept any interference received, including interference that may cause undesired operation.

Note: This equipment has been tested and found to comply with the limits for a Class B digital device, pursuant to Part 15 of the FCC Rules. These limits are designed to provide reasonable protection against harmful interference in a residential installation. This equipment generates, uses and can radiate radio frequency energy and, if not installed and used in accordance with the instructions, may cause harmful interference to radio communications.

However, there is no guarantee that interference will not occur in a particular installation. If this equipment does cause harmful interference to radio or television reception, which can be determined by turning the equipment off and on, the user is encouraged to try to correct the interference by one or more of the following measures:

- Reorient or relocate the receiving antenna.
- Increase the separation between the equipment and receiver.
- Connect the equipment into an outlet on a circuit different from that to which the receiver is connected.
- Consult the dealer or an experienced radio/TV technician for help.

Use of a shielded cable is required to comply with Class B limits in Subpart B of Part 15 of the FCC Rules.

Do not make any changes or modifications to the equipment unless otherwise specified in the manual. If such changes or modifications should be made, you could be required to stop operation of the equipment.

FCC ID:AZDK30365

Changes or modifications not expressly approved by the party responsible for compliance could void the user's authority to operate equipment.

This transmitter must not be co-located or operating in conjunction with any other antenna or transmitter.

The equipment complies with FCC radiation exposure limits for uncontrolled equipment. This equipment should be installed and operated with minimum distance at least 20cm between the radiator and persons body (excluding extremities: hands, wrists, feet and ankles) and must not be colocated or operated with any other antenna or transmitter.

Canon U.S.A., Inc.

One Canon Park

Melville, New York 11747

1-800-652-2666

Users in Canada

This device complies with Industry Canada license-exempt RSS standard(s). Operation is subject to the following two conditions:

(1) this device may not cause interference, and (2) this device must accept any interference, including interference that may cause undesired operation of the device.

This equipment complies with IC radiation exposure limits set forth for an uncontrolled environment and meets RSS-102 of the IC radio frequency (RF) Exposure rules. This equipment should be installed and operated keeping the radiator at least 20cm or more away from person's body (excluding extremities: hands, wrists, feet and ankles).

Pour les usagers résidant au Canada

Le présent appareil est conforme aux CNR d'Industrie Canada applicables aux appareils radio exempts de licence. L'exploitation est autorisée aux deux conditions suivantes :

(1) l'appareil ne doit pas produire de brouillage, et (2) l'utilisateur de l'appareil doit accepter tout brouillage radioélectrique subi, même si le brouillage est susceptible d'en compromettre le fonctionnement.

Cet équipement est conforme aux limites d'exposition aux rayonnements énoncées pour un environnement non contrôlé et respecte les règles d'exposition aux fréquences radioélectriques (RF) CNR-102 de l'IC. Cet équipement doit être installé et utilisé en gardant une distance de 20 cm ou plus entre le dispositif rayonnant et le corps (à l'exception des extrémités : mains, poignets, pieds et chevilles).

Environmental Information

Reducing your environmental impact

Power Consumption and Operational Modes

The amount of electricity a device consumes depends on the way the device is used. This product is designed and set in a way to allow you to reduce the power consumption. After the last print it switches to Ready Mode. In this mode it can print again immediately if required. If the product is not used for a time, the device switches to its Sleep Mode. The devices consume less power (Watt) in these modes.

Energy Star®

The Energy Star® programme is a voluntary scheme to promote the development and purchase of energy efficient models, which help to minimise environmental impact.

Products which meet the stringent requirements of the Energy Star® programme for both environmental benefits and the amount of energy consumption will carry the Energy Star® logo accordingly.

Paper types

This product can be used to print on both recycled and virgin paper (certified to an environmental stewardship scheme), which complies with EN12281 or a similar quality standard. In addition it can support printing on media down to a weight of 64g/m², lighter paper means less resources used and a lower environmental footprint for your printing needs.



CE

WEEE (EU&EEA)

Only for European Union and EEA (Norway, Iceland and Liechtenstein)



This symbol indicates that this product is not to be disposed of with your household waste, according to the WEEE Directive (2012/19/EU) and national legislation. This product should be handed over to a designated collection point, e.g., on an authorized one-for-one basis when you buy a new similar product or to an authorized collection site for recycling waste electrical and electronic equipment (EEE). Improper handling of this type of waste could have a possible negative impact on the environment and human health due to potentially hazardous substances that are generally associated with EEE. At the same time, your cooperation in the correct disposal of this product will contribute to the effective usage of natural resources. For more information about where you can drop off your waste equipment for recycling, please contact your local city office, waste authority, approved WEEE scheme or your household waste disposal service. For more information regarding return and recycling of WEEE products, please visit www.canon-europe.com/weee.

Nur für Europäische Union und EWR (Norwegen, Island und Liechtenstein)



Dieses Symbol weist darauf hin, dass dieses Produkt gemäß der EU-Richtlinie über Elektro- und Elektronik-Altgeräte (2012/19/EU) und nationalen Gesetzen nicht über den Hausmüll entsorgt werden darf. Dieses Produkt muss bei einer dafür vorgesehenen Sammelstelle abgegeben werden. Dies kann z. B. durch Rückgabe beim Kauf eines ähnlichen Produkts oder durch Abgabe bei einer autorisierten Sammelstelle für die Wiederaufbereitung von Elektro- und Elektronik-Altgeräten geschehen. Der unsachgemäße Umgang mit Altgeräten kann aufgrund potentiell gefährlicher Stoffe, die generell mit Elektro- und Elektronik-Altgeräten in Verbindung stehen, negative Auswirkungen auf die Umwelt und die menschliche Gesundheit haben. Durch die umweltgerechte Entsorgung dieses Produkts tragen Sie außerdem zu einer effektiven Nutzung natürlicher Ressourcen bei. Informationen zu Sammelstellen für Altgeräte erhalten Sie bei Ihrer Stadtverwaltung, dem öffentlich-rechtlichen Entsorgungsträger, einer autorisierten Stelle für die Entsorgung von Elektro- und Elektronik-Altgeräten oder Ihrem örtlichen Entsorgungsunternehmen. Weitere Informationen zur Rückgabe und Entsorgung von Elektro- und Elektronik-Altgeräten finden Sie unter www.canon-europe.com/weee.

Union Européenne, Norvège, Islande et Liechtenstein uniquement.



Ce symbole indique que ce produit ne doit pas être jeté avec les ordures ménagères, conformément à la directive DEEE (2012/19/UE) et à la réglementation de votre pays. Ce produit doit être confié au distributeur à chaque fois que vous achetez un produit neuf similaire, ou à un point de collecte mis en

place par les collectivités locales pour le recyclage des Déchets des Équipements Électriques et Électroniques (DEEE). Le traitement inapproprié de ce type de déchet risque d'avoir des répercussions sur l'environnement et la santé humaine, du fait de la présence de substances potentiellement dangereuses généralement associées aux équipements électriques et électroniques. Parallèlement, votre entière coopération dans le cadre de la mise au rebut correcte de ce produit favorisera une meilleure utilisation des ressources naturelles. Pour plus d'informations sur les points de collecte des équipements à recycler, contactez vos services municipaux, les autorités locales compétentes, le plan DEEE approuvé ou le service d'enlèvement des ordures ménagères. Pour plus d'informations sur le retour et le recyclage des produits DEEE, consultez le site: www.canon-europe.com/weee.

Uitsluitend bestemd voor de Europese Unie en EER (Noorwegen, IJsland en Liechtenstein)



Dit symbool geeft aan dat dit product in overeenstemming met de AEEA-richtlijn (2012/19/EU) en de nationale wetgeving niet mag worden afgevoerd met het huishoudelijk afval. Dit product moet worden ingeleverd bij een aangewezen, geautoriseerd inzamelpunt, bijvoorbeeld wanneer u een nieuw gelijksoortig product aanschaft, of bij een geautoriseerd inzamelpunt voor hergebruik van elektrische en elektronische apparatuur (EEA). Een onjuiste afvoer van dit type afval kan leiden tot negatieve effecten op het milieu en de volksgezondheid als gevolg van potentieel gevaarlijke stoffen die veel voorkomen in elektrische en elektronische apparatuur (EEA). Bovendien werkt u door een juiste afvoer van dit product mee aan het effectieve gebruik van natuurlijke hulpbronnen. Voor meer informatie over waar u uw afgedankte apparatuur kunt inleveren voor recycling kunt u contact opnemen met het gemeentehuis in uw woonplaats, de reinigingsdienst, of het afvalverwerkingsbedrijf. U kunt ook het schema voor de afvoer van afgedankte elektrische en elektronische apparatuur (AEEA) raadplegen. Ga voor meer informatie over het inzamelen en recyclen van afgedankte elektrische en elektronische apparatuur naar www.canon-europe.com/weee.

Sólo para la Unión Europea y el Área Económica Europea (Noruega, Islandia y Liechtenstein)



Este símbolo indica que este producto no debe desecharse con los desperdicios domésticos, de acuerdo con la directiva RAEE (2012/19/UE) y con la legislación nacional. Este producto debe entregarse en uno de los puntos de recogida designados, como por ejemplo, entregándolo en el lugar de venta al comprar un producto similar o depositándolo en un lugar de recogida autorizado para el reciclado de residuos de aparatos eléctricos y electrónicos (RAEE). La manipulación inapropiada de este tipo de desechos podría tener un impacto negativo en el entorno y la salud humana, debido a las sustancias potencialmente peligrosas que normalmente están asociadas con los RAEE. Al mismo tiempo, su cooperación a la hora de desechar correctamente este producto contribuirá a la utilización eficaz de los recursos naturales. Para más información sobre cómo puede eliminar el equipo para su reciclado, póngase en contacto con las autoridades locales, con las autoridades encargadas de los desechos, con un sistema de gestión RAEE

autorizado o con el servicio de recogida de basuras doméstico. Si desea más información acerca de la devolución y reciclado de RAEE, visite la web www.canon-europe.com/weee.

Només per a la Unió Europea i a l'Espai Econòmic Europeu (Noruega, Islàndia i Liechtenstein)



Aquest símbol indica que aquest producte no s'ha de llençar a les escombraries de la llar, d'acord amb la Directiva RAEE (2012/19/UE) i la legislació nacional. Aquest producte s'hauria de lliurar en un dels punts de recollida designats, com per exemple, intercanviant-lo un per un en comprar un producte similar o lliurant-lo en un lloc de recollida autoritzat per al reciclatge de residus d'aparells elèctrics i electrònics (AEE). La manipulació inadequada d'aquest tipus de residus podria tenir un impacte negatiu en l'entorn i en la salut humana, a causa de les substàncies potencialment perilloses que normalment estan associades als AEE. Així mateix, la vostra cooperació a l'hora de llençar correctament aquest producte contribuirà a la utilització efectiva dels recursos naturals. Per a més informació sobre els punts on podeu lliurar aquest producte per procedir al seu reciclatge, adreceu-vos a la vostra oficina municipal, a les autoritats encarregades dels residus, al pla de residus homologat per la RAEE o al servei de recollida de deixalles domèstiques de la vostra localitat. Per a més informació sobre la devolució i el reciclatge de productes RAEE, visiteu www.canon-europe.com/weee.

Solo per Unione Europea e SEE (Norvegia, Islanda e Liechtenstein)



Questo simbolo indica che il prodotto deve essere oggetto di raccolta separata in conformità alla Direttiva RAEE (2012/19/UE) e alla normativa locale vigente. Il prodotto deve essere smaltito presso un centro di raccolta differenziata, un distributore autorizzato che applichi il principio dell'"uno contro uno", ovvero del ritiro della vecchia apparecchiatura elettrica al momento dell'acquisto di una nuova, o un impianto autorizzato al riciclaggio dei rifiuti di apparecchiature elettriche ed elettroniche. La gestione impropria di questo tipo di rifiuti può avere un impatto negativo sull'ambiente e sulla salute umana causato dalle sostanze potenzialmente pericolose che potrebbero essere contenute nelle apparecchiature elettriche ed elettroniche. Un corretto smaltimento di tali prodotti contribuirà inoltre a un uso efficace delle risorse naturali ed eviterà di incorrere nelle sanzioni amministrative di cui all'art. 255 e successivi del Decreto Legislativo n. 152/06. Per ulteriori informazioni sullo smaltimento e il recupero dei Rifiuti di Apparecchiature Elettriche ed Elettroniche, consultare la Direttiva RAEE, rivolgersi alle autorità competenti, oppure visitare il sito www.canon-europe.com/weee.

Apenas para a União Europeia e AEE (Noruega, Islândia e Liechtenstein)



Este símbolo indica que o produto não deve ser colocado no lixo doméstico, de acordo com a Directiva REEE (2012/19/UE) e a legislação nacional. Este produto deverá ser colocado num ponto de recolha designado, por exemplo, num local próprio autorizado quando adquirir um produto semelhante novo ou num local de recolha autorizado para reciclar resíduos de equipamentos eléctricos e electrónicos (EEE). O tratamento inadequado deste tipo de resíduo poderá causar um impacto negativo no ambiente e na saúde humana devido às substâncias potencialmente perigosas normalmente associadas aos equipamentos eléctricos e electrónicos. Simultaneamente, a sua cooperação no tratamento correcto deste produto contribuirá para a utilização eficaz dos recursos naturais. Para mais informações sobre os locais onde o equipamento poderá ser reciclado, contacte os serviços locais, a autoridade responsável pelos resíduos, o esquema REEE aprovado ou o serviço de tratamento de lixo doméstico. Para mais informações sobre a devolução e reciclagem de produtos REEE, vá a www.canon-europe.com/weee.

Gælder kun i Europæiske Union og EØS (Norge, Island og Liechtenstein)



Dette symbol angiver, at det pågældende produkt ikke må bortskaffes sammen med dagrenovation jf. direktivet om affald af elektrisk og elektronisk udstyr (WEEE) (2012/19/EU) og gældende national lovgivning. Det pågældende produkt skal afleveres på et nærmere specificeret indsamlingssted, f.eks. i overensstemmelse med en godkendt én-til-én-procedure, når du indkøber et nyt tilsvarende produkt, eller produktet skal afleveres på et godkendt indsamlingssted for elektronikaffald. Forkert håndtering af denne type affald kan medføre negative konsekvenser for miljøet og menneskers helbred på grund af de potentielt sundhedsskadelige stoffer, der generelt kan forefindes i elektrisk og elektronisk udstyr. Når du foretager korrekt bortskaffelse af det pågældende produkt, bidrager du til effektiv brug af naturressourcerne. Yderligere oplysninger om, hvor du kan bortskaffe dit elektronikaffald med henblik på genanvendelse, får du hos de kommunale renovationsmyndigheder. Yderligere oplysninger om returnering og genanvendelse af affald af elektrisk og elektronisk udstyr får du ved at besøge www.canon-europe.com/weee.

Μόνο για την Ευρωπαϊκή Ένωση και τον ΕΟΧ (Νορβηγία, Ισλανδία και Λιχτενστάιν)



Αυτό το σύμβολο υποδηλώνει ότι αυτό το προϊόν δεν πρέπει να απορρίπτεται μαζί με τα οικιακά απορρίμματα, σύμφωνα με την Οδηγία σχετικά με τα Απόβλητα Ηλεκτρικού και Ηλεκτρονικού Εξοπλισμού (ΑΗΗΕ) (2012/19/ΕΕ) και την εθνική σας νομοθεσία. Αυτό το προϊόν πρέπει να παραδίδεται σε καθορισμένο σημείο συλλογής, π.χ. σε μια εξουσιοδοτημένη βάση ανταλλαγής όταν αγοράζετε ένα νέο παρόμοιο προϊόν ή σε μια εξουσιοδοτημένη θέση συλλογής για την ανακύκλωση των αποβλήτων Ηλεκτρικού και Ηλεκτρονικού Εξοπλισμού (ΗΗΕ). Ο ακατάλληλος χειρισμός αυτού του τύπου αποβλήτων μπορεί να έχει αρνητικό αντίκτυπο στο περιβάλλον και την υγεία του ανθρώπου, λόγω δυνητικώς επικίνδυνων ουσιών που γενικά συνδέονται με τον ΗΗΕ. Ταυτόχρονα, η συνεργασία σας όσον αφορά τη σωστή απόρριψη αυτού του προϊόντος θα συμβάλει στην αποτελεσματική χρήση των φυσικών πόρων. Για περισσότερες πληροφορίες σχετικά με τα σημεία όπου μπορείτε να απορρίψετε τον εξοπλισμό σας για

ανακύκλωση, επικοινωνήστε με το τοπικό γραφείο της πόλης σας, την υπηρεσία απορριμμάτων, το εγκεκριμένο σχήμα ΑΗΗΕ ή την υπηρεσία απόρριψης οικιακών αποβλήτων. Για περισσότερες πληροφορίες σχετικά με την επιστροφή και την ανακύκλωση των προϊόντων ΑΗΗΕ, επισκεφθείτε την τοποθεσία www.canon-europe.com/weee.

Gjelder kun den europeiske union og EØS (Norge, Island og Liechtenstein)



Dette symbolet indikerer at dette produktet ikke skal kastes sammen med husholdningsavfall, i henhold til WEEE-direktiv (2012/19/EU) og nasjonal lov. Produktet må leveres til et dertil egnet innsamlingspunkt, det vil si på en autorisert en-til-en-basis når du kjøper et nytt lignende produkt, eller til et autorisert innsamlingssted for resirkulering av avfall fra elektrisk og elektronisk utstyr (EE-utstyr). Feil håndtering av denne typen avfall kan være miljø- og helseskadelig på grunn av potensielt skadelige stoffer som ofte brukes i EE-utstyr. Samtidig bidrar din innsats for korrekt avhending av produktet til effektiv bruk av naturressurser. Du kan få mer informasjon om hvor du kan avhende utrangert utstyr til resirkulering ved å kontakte lokale myndigheter, et godkjent WEEE-program eller husholdningens renovasjonsselskap. Du finner mer informasjon om retur og resirkulering av WEEE-produkter på www.canon-europe.com/weee.

Vain Euroopan unionin sekä ETA:n (Norja, Islanti ja Liechtenstein) alueelle.



Tämä tunnus osoittaa, että sähkö- ja elektroniikkalaiteromua koskeva direktiivi (SER-direktiivi, 2012/19/EU) sekä kansallinen lainsäädäntö kieltävät tuotteen hävittämisen talousjätteen mukana. Tuote on vietävä asianmukaiseen keräyspisteeseen, esimerkiksi kodinkoneliikkeeseen uutta vastaavaa tuotetta ostettaessa tai viralliseen sähkö- ja elektroniikkalaiteromun keräyspisteeseen. Sähkö- ja elektroniikkalaiteromun virheellinen käsittely voi vahingoittaa ympäristöä ja ihmisten terveyttä, koska laitteet saattavat sisältää ympäristölle ja terveydelle haitallisia aineita. Lisäksi tuotteen asianmukainen hävittäminen säästää luonnonvaroja. Lisätietoja sähkö- ja elektroniikkalaiteromun keräyspisteistä saat kaupunkien ja kuntien tiedotuksesta, jätehuoltoviranomaisilta, sähkö- ja elektroniikkalaiteromun kierrätysjärjestelmän ylläpitäjältä ja jätehuoltoyhtiöltä. Lisätietoja sähkö- ja elektroniikkalaiteromun keräyksestä ja kierrätyksestä on osoitteessa www.canon-europe.com/weee.

Endast för Europeiska unionen och EES (Norge, Island och Liechtenstein)



Den här symbolen visar att produkten enligt WEEE-direktivet (2012/19/EU) och nationell lagstiftning inte får sorteras och slängas som hushållsavfall. Den här produkten ska lämnas in på en därför avsedd insamlingsplats, t.ex. på en återvinningsstation auktoriserad att hantera elektrisk och elektronisk utrustning (EE-utrustning) eller hos handlare som är auktoriserade att byta in varor då nya, motsvarande

köps (en mot en). Olämplig hantering av avfall av den här typen kan ha en negativ inverkan på miljön och människors hälsa på grund av de potentiellt farliga ämnen som kan återfinnas i elektrisk och elektronisk utrustning. Din medverkan till en korrekt avfallshantering av den här produkten bidrar dessutom till en effektiv användning av naturresurserna. Kontakta ditt lokala kommunkontor, berörd myndighet, företag för avfallshantering eller ta del av en godkänd WEEE-organisation om du vill ha mer information om var du kan lämna den kasserade produkten för återvinning. För mer information om inlämning och återvinning av WEEE-produkter, se www.canon-europe.com/weee.

Pouze Evropská unie a EHP (Norsko, Island a Lichtenštejsko)



Tento symbol znamená, že podle směrnice o OEEZ (2012/19/EU) a podle vnitrostátních právních předpisů nemá být tento výrobek likvidován s odpadem z domácností. Tento výrobek má být vrácen do sběrného místa, např. v rámci autorizovaného systému odběru jednoho výrobku za jeden nově prodaný podobný výrobek nebo v autorizovaném sběrném místě pro recyklaci odpadních elektrických a elektronických zařízení (OEEZ). Nevhodné nakládání s tímto druhem odpadu by mohlo mít negativní dopad na životní prostředí a lidské zdraví, protože elektrická a elektronická zařízení zpravidla obsahují potenciálně nebezpečné látky. Vaše spolupráce na správné likvidaci tohoto výrobku současně napomůže efektivnímu využívání přírodních zdrojů. Další informace o místech sběru vašeho odpadního zařízení k recyklaci vám sdělí místní úřad vaší obce, správní orgán vykonávající dozor nad likvidací odpadu, sběrný OEEZ nebo služba pro odvoz komunálního odpadu. Další informace týkající se vracení a recyklace OEEZ naleznete na adrese www.canon-europe.com/weee.

Csak az Európai Unió és az EGT (Norvégia, Izland és Liechtenstein) országokban



Ez a szimbólum azt jelzi, hogy a helyi törvények és a WEEE-irányelv (2012/19/EU) szerint a termék nem kezelhető háztartási hulladékként. A terméket a kijelölt nyilvános gyűjtőpontokon kell leadni, például hasonló cserekészülék vásárlásakor, illetve bármelyik, elektromos és elektronikai berendezésekből származó hulladék (WEEE) átvételére feljogosított gyűjtőponton. Az ilyen jellegű hulladékok a nem megfelelő kezelés esetén a bennük található veszélyes anyagok révén ártalmasak lehetnek a környezetre és az emberek egészségére. Továbbá, a termékből származó hulladék megfelelő kezelésével hozzájárulhat a természetes nyersanyagok hatékonyabb hasznosításához. A berendezésekből származó, újrahasznosítható hulladékok elhelyezésére vonatkozó további tudnivalóért forduljon a helyi önkormányzathoz, a közterület-fenntartó vállalathoz, a háztartási hulladék begyűjtését végző vállalathoz, illetve a hivatalos WEEE-képviselőhöz. További tudnivalókat a WEEE-termékek visszajuttatásáról és újrahasznosításáról a www.canon-europe.com/weee.

Tylko dla krajów Unii Europejskiej oraz EOG (Norwegia, Islandia i Liechtenstein)



Ten symbol oznacza, że zgodnie z dyrektywą WEEE dotyczącą zużytego sprzętu elektrycznego i elektronicznego (2012/19/UE) oraz przepisami lokalnymi nie należy wyrzucać tego produktu razem z odpadami gospodarstwa domowego. Produkt należy przekazać do wyznaczonego punktu gromadzenia odpadów, np. firmie, od której kupowany jest nowy, podobny produkt lub do autoryzowanego punktu gromadzenia zużytego sprzętu elektrycznego i elektronicznego w celu poddania go recyklingowi. Usuwanie tego typu odpadów w nieodpowiedni sposób może mieć negatywny wpływ na otoczenie i zdrowie innych osób ze względu na niebezpieczne substancje stosowane w takim sprzęcie. Jednocześnie pozbycie się zużytego sprzętu w zalecany sposób przyczynia się do właściwego wykorzystania zasobów naturalnych. Aby uzyskać więcej informacji na temat punktów, do których można dostarczyć sprzęt do recyklingu, prosimy skontaktować się z lokalnym urzędem miasta, zakładem utylizacji odpadów, skorzystać z instrukcji zatwierdzonej dyrektywą WEEE lub skontaktować się z przedsiębiorstwem zajmującym się wywozem odpadów domowych. Więcej informacji o zwracaniu i recyklingu zużytego sprzętu elektrycznego i elektronicznego znajduje się w witrynie www.canon-europe.com/weee.

Plati len pre štáty Európskej únie a EHP (Nórsko, Island a Lichtenštajnsko)



Tento symbol znamená, že podľa Smernice 2012/19/EÚ o odpade z elektrických a elektronických zariadení (OEEZ) a podľa platnej legislatívy Slovenskej republiky sa tento produkt nesmie likvidovať spolu s komunálnym odpadom. Produkt je potrebné odovzdať do určenej zberne, napr. prostredníctvom výmeny za kúpu nového podobného produktu, alebo na autorizované zberné miesto, ktoré spracúva odpad z elektrických a elektronických zariadení (EEZ). Nesprávna manipulácia s takýmto typom odpadu môže mať negatívny vplyv na životné prostredie a ľudské zdravie, pretože elektrické a elektronické zariadenia obsahujú potenciálne nebezpečné látky. Spoluprácou na správnej likvidácii produktu prispejete k účinnému využívaniu prírodných zdrojov. Ďalšie informácie o mieste recyklácie opotrebovaných zariadení získate od miestneho úradu, úradu životného prostredia, zo schváleného plánu OEEZ alebo od spoločnosti, ktorá zaisťuje likvidáciu komunálneho odpadu. Viac informácií nájdete aj na webovej stránke: www.canon-europe.com/weee.

Üksnes Euroopa Liit ja EMP (Norra, Island ja Liechtenstein)



See sümbol näitab, et antud toodet ei tohi vastavalt elektri- ja elektroonikaseadmete jäätmeid käsitlevale direktiivile (2012/19/EL) ning teie riigis kehtivatele õigusaktidele utiliseerida koos olmejäätmetega. Antud toode tuleb anda selleks määratud kogumispunkti, nt müügipunkt, mis on volitatud üks ühe vastu vahetama, kui ostate uue sarnase toote, või elektri- ja elektroonikaseadmete jäätmete ümbertöötlemiseks

mõeldud kogumispunkti. Täiendava teabe saamiseks elektri- ja elektroonikaseadmetest tekkinud jäätmete tagastamise ja ümbertöötlemise kohta võtke ühendust kohaliku omavalitsusega, asjakohase valitsusasutusega, asjakohase tootjavastutusorganisatsiooniga või olmejäätmete käitlejaga. Lisateavet leitate ka Interneti-leheküljelt www.canon-europe.com/weee.

Tikai Eiropas Savienībai un EEZ (Norvēģijai, Islandei un Lihtenšteinai)



Šis simbols norāda, ka atbilstoši ES Direktīvai (2012/19/ES) par elektrisko un elektronisko iekārtu atkritumiem (EEIA) un vietējiem tiesību aktiem no šī izstrādājuma nedrīkst atbrīvoties, izmetot to kopā ar sadzīves atkritumiem. Šis izstrādājums ir jānodod piemērotā savākšanas vietā, piemēram, apstiprinātā veikalā, kur iegādājaties līdzīgu jaunu produktu un atstājat veco, vai apstiprinātā vietā izlietotu elektrisko un elektronisko iekārtu pārstrādei. Nepareiza šāda veida atkritumu apsaimniekošana var apdraudēt vidi un cilvēka veselību tādu iespējami bīstamu vielu dēļ, kas parasti ir elektriskajās un elektroniskajās iekārtās. Turklāt jūsu atbalsts pareizā šāda veida atkritumu apsaimniekošanā sekmēs efektīvu dabas resursu izmantošanu. Lai saņemtu pilnīgāku informāciju par vietām, kur izlietoto iekārtu var nodot pārstrādei, sazinieties ar vietējo pašvaldību, atkritumu savākšanas atbildīgo dienestu, pilnvarotu EEIA struktūru vai sadzīves atkritumu apsaimniekošanas iestādi. Lai saņemtu plašāku informāciju par elektrisko un elektronisko iekārtu nodošanu pārstrādei, apmeklējiet tīmekļa vietni www.canon-europe.com/weee.

Tik Europos Sąjungai ir EEE (Norvegijai, Islandijai ir Lichtenšteinai)



Šis ženkla reiškia, kad gaminio negalima išmesti su buitinėmis atliekomis, kaip yra nustatyta Direktyvoje (2012/19/ES) ir nacionaliniuose teisė aktuose dėl EEJ atliekų tvarkymo. Šį gaminį reikia atiduoti į tam skirtą surinkimo punktą, pvz., pagal patvirtintą keitimo sistemą, kai perkamas panašus gaminy, arba į elektros ir elektroninės įrangos (EEJ) atliekų perdirbimo punktą. Netinkamas tokios rūšies atliekų tvarkymas dėl elektros ir elektroninėje įrangoje esančių pavojingų medžiagų gali pakenkti aplinkai ir žmonių sveikatai. Padėdami užtikrinti tinkamą šio gaminio šalinimo tvarką, kartu prisidėsite prie veiksmingo gamtos išteklių naudojimo. Jei reikia daugiau informacijos, kaip šalinti tokias atliekas, kad jos būtų toliau perdirbamos, kreipkitės į savo miesto valdžios institucijas, atliekų tvarkymo organizacijas, patvirtintų EEJ atliekų sistemų arba jūsų buitinių atliekų tvarkymo įstaigų atstovus. Išsamesnės informacijos apie EEJ atliekų grąžinimo ir perdirbimo tvarką galite rasti apsilankę tinklalapyje www.canon-europe.com/weee.

Samo za Evropsko unijo in EGP (Norveška, Islandija in Lihtenštajn)



Ta simbol pomeni, da tega izdelka v skladu z direktivo OEE0 (2012/19/EU) in državno zakonodajo ne smete odvreči v gospodinjske odpadke. Ta izdelek morate odložiti na ustrezno zbiralno mesto, na primer pri pooblaščenem prodajalcu, ko kupite podoben nov izdelek ali na zbiralno mesto za recikliranje električne in elektronske opreme. Neprimerno ravnanje s takšnimi odpadki lahko negativno vpliva na okolje in človekovo zdravje zaradi nevarnih snovi, ki so povezane z električno in elektronsko opremo. S pravilno odstranitvijo izdelka hkrati prispevate tudi k učinkoviti porabi naravnih virov. Če želite več informacij o tem, kje lahko odložite odpadno opremo za recikliranje, pokličite občinski urad, komunalno podjetje ali službo, ki skrbi za odstranjevanje odpadkov, ali si oglejte načrt OEE0. Če želite več informacij o vračanju in recikliranju izdelkov v skladu z direktivo OEE0, obiščite www.canon-europe.com/weee.

Само за Европейския съюз и ЕИП (Норвегия, Исландия и Лихтенщайн)



Този символ показва, че този продукт не трябва да се изхвърля заедно с битовите отпадъци, съгласно Директивата за ИУЕЕО (2012/19/ЕС) и Вашето национално законодателство. Този продукт трябва да бъде предаден в предназначен за целта пункт за събиране, например на база размяна, когато купувате нов подобен продукт, или в одобрен събирателен пункт за рециклиране на излязло от употреба електрическо и електронно оборудване (ИУЕЕО). Неправилното третиране на този тип отпадъци може да доведе до евентуални отрицателни последици за околната среда и човешкото здраве поради потенциално опасните вещества, които обикновено са свързани с ЕЕО. В същото време Вашето съдействие за правилното изхвърляне на този продукт ще допринесе за ефективното използване на природните ресурси. Повече информация относно местата, където може да предавате излязло от употреба оборудване за рециклиране, може да получите от местните власти, от органа, отговорен за отпадъците и от одобрена система за излязло от употреба ЕЕО или от Вашата местна служба за битови отпадъци. За повече информация относно връщането и рециклирането на продукти от излязло от употреба ЕЕО посетете www.canon-europe.com/weee.

Doar pentru Uniunea Europeană și EEA (Norvegia, Islanda și Liechtenstein)



Acest simbol indică faptul că acest produs nu trebuie aruncat o dată cu reziduurile menajere, în conformitate cu Directiva DEEE (Directiva privind deșeurile de echipamente electrice și electronice) (2012/19/UE) și legile naționale. Acest produs trebuie transportat la un punct de colectare special, de exemplu un centru care preia produsele vechi atunci când achiziționați un produs nou similar, sau la un punct de colectare autorizat pentru reciclarea deșeurilor provenite de la echipamentele electrice și electronice (EEE). Mănuirea necorespunzătoare a acestor tipuri de deșeuri poate avea un impact negativ asupra mediului înconjurător și sănătății indivizilor, din cauza substanțelor potențial nocive care sunt în general asociate cu EEE. În același timp, cooperarea dvs. la reciclarea corectă a acestui produs va contribui la utilizarea efectivă a resurselor naturale. Pentru mai multe informații privind locurile de reciclare a deșeurilor provenite de la echipamente, contactați biroul primăriei locale, autoritatea responsabilă cu colectarea deșeurilor, schema DEEE aprobată sau serviciul de colectare a deșeurilor menajere. Pentru

mai multe informații privind returnarea și reciclarea produselor DEEE, vizitați www.canon-europe.com/weee.

Samo za Europsku uniju i EEZ (Norveška, Island i Lihtenštajn)



Ovaj simbol pokazuje da se ovaj proizvod ne smije odlagati s kućnim otpadom sukladno WEEE Direktivi (2012/19/EC) i vašem nacionalnom zakonu. Ovaj proizvod je potrebno predati na posebno mjesto za sakupljanje otpada, npr. na ovlašteno mjesto gdje možete zamijeniti staro za novo ukoliko kupujete novi sličan proizvod ili na ovlašteno mjesto za sakupljanje rabljene električne i elektroničke opreme (EEE) za recikliranje. Nepropropisno rukovanje ovom vrstom otpada može imati negativan učinak na okolinu i zdravlje ljudi zbog supstanci koje su potencijalno opasne za zdravlje, a općenito se povezuju s EEE. Istovremeno, vaša će suradnja kroz propisno odlaganje ovog proizvoda doprinijeti efektivnoj uporabi prirodnih resursa. Za više informacija o tome gdje možete odložiti svoj otpad za recikliranje obratite se vašem lokalnom gradskom uredu, komunalnoj službi, odobrenom WEEE programu ili službi za odlaganje kućnog otpada. Ostale informacije o vraćanju i recikliranju WEEE proizvoda potražite na www.canon-europe.com/weee.

Korisnici u Srbiji



Ovaj simbol označava da ovaj proizvod ne sme da se odlaže sa ostalim kućnim otpadom, u skladu sa WEEE Direktivom (2012/19/EU) i nacionalnim zakonima. Ovaj proizvod treba predati određenom centru za prikupljanje, npr. na osnovi "jedan-za-jedan" kada kupujete sličan novi proizvod, ili ovlašćenom centru za prikupljanje za reciklažu istrošene električne i elektronske opreme (EEE). Nepravilno rukovanje ovom vrstom otpada može da ima moguće negativne posledice po životnu sredinu i ljudsko zdravlje usled potencijalno opasnih materijala koji se uglavnom vezuju za EEE. U isto vreme, vaša saradnja na ispravnom odlaganju ovog proizvoda će doprineti efikasnom korišćenju prirodnih resursa. Za više informacija o tome gde možete da predate vašu staru opremu radi recikliranja, vas molimo, da kontaktirate lokalne gradske vlasti, komunalne službe, odobreni plan reciklaže ili Gradsku čistoću. Za više informacija o vraćanju i recikliranju WEEE proizvoda, posetite stranicu www.canon-europe.com/weee.

Main Components and Their Use

- ▶ **Main Components**
- ▶ **Power Supply**
- ▶ **LCD and Operation Panel**

Main Components

- ▶ **Front View**
- ▶ **Rear View**
- ▶ **Inside View**
- ▶ **Operation Panel**

Front View

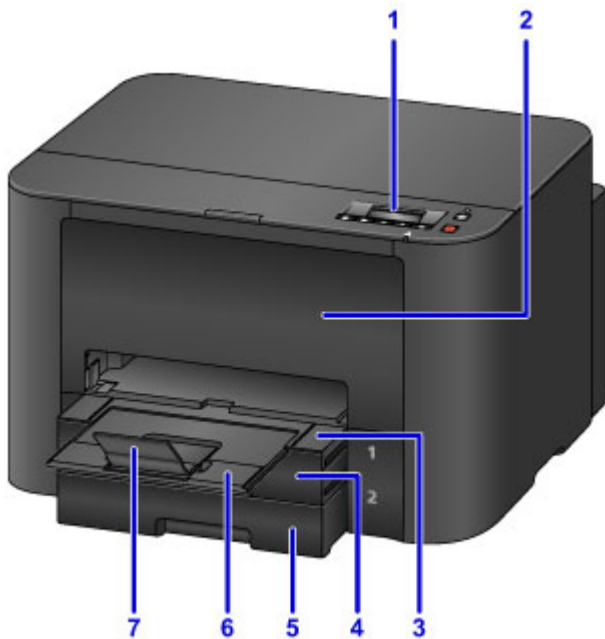

(1) operation panel

Used to adjust settings or operate the printer.

■ [Operation Panel](#)

(2) front cover

Open to replace ink tanks or clear internal paper jams.

(3) paper output tray

Pull out to support printed documents. The tray covers the cassette when extended. Normally, leave the tray out.

(4) cassette 1

Holds all sizes of paper that are compatible with the printer, such as plain paper, photo paper, and envelopes.

■ [Paper Sources](#)

(5) cassette 2

Holds A4, Letter, Legal, Oficio, B-Oficio, M-Oficio, Foolscap, and Legal (India)-sized plain paper.

■ [Paper Sources](#)

(6) output tray extension

Pull out to support ejected paper.

(7) paper output support

Open to support ejected paper.

Rear View

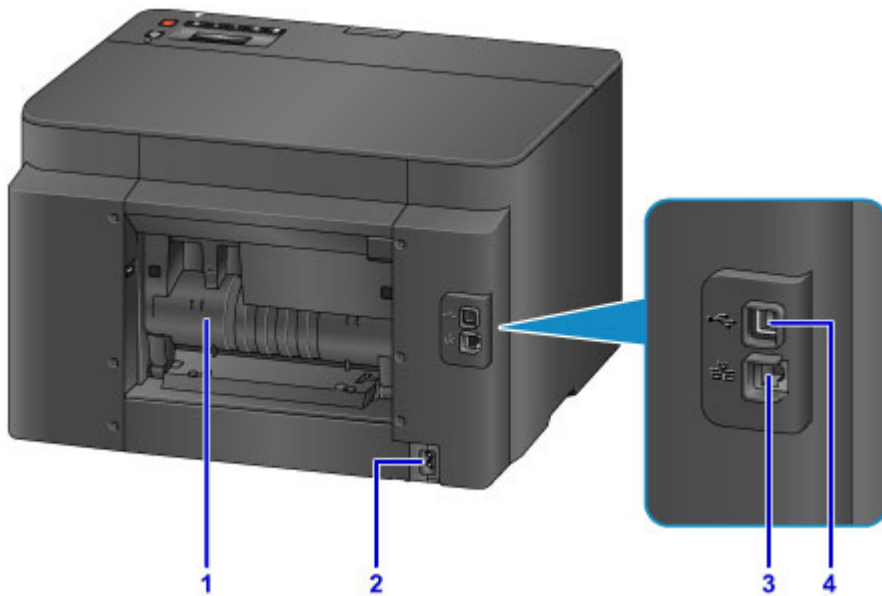

(1) rear cover

Open to clear paper jams.

(2) power cord connector

Connect the supplied power cord.

(3) wired LAN connector

Connect an Ethernet cable to use the printer in a local network.

(4) USB port

Connect the USB cable for a direct connection with a computer.

▶▶ Important

- Do not touch any exposed metal parts.
- Do not connect or disconnect the USB or Ethernet cable while printing from a computer.

Inside View

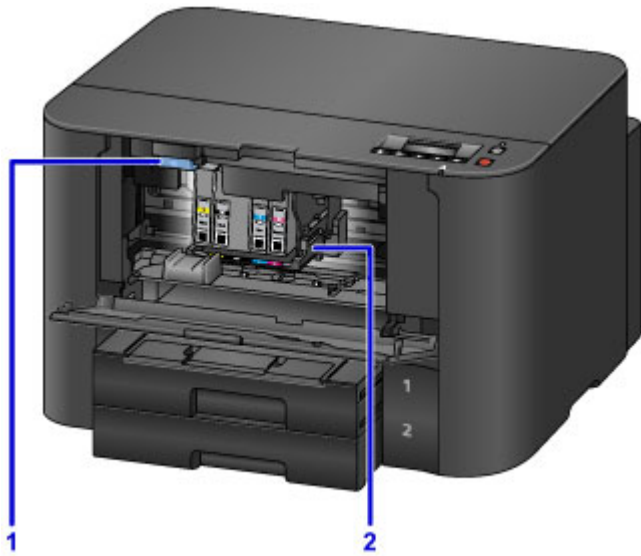

(1) ink tank eject lever

Push up to remove ink tanks.

(2) print head holder

The print head is pre-installed.

▶▶▶ Note

- For instructions on replacing ink tanks, see [Replacing Ink Tanks](#).

Operation Panel

* Here, all operation panel indicators are shown lit for the purpose of illustration.

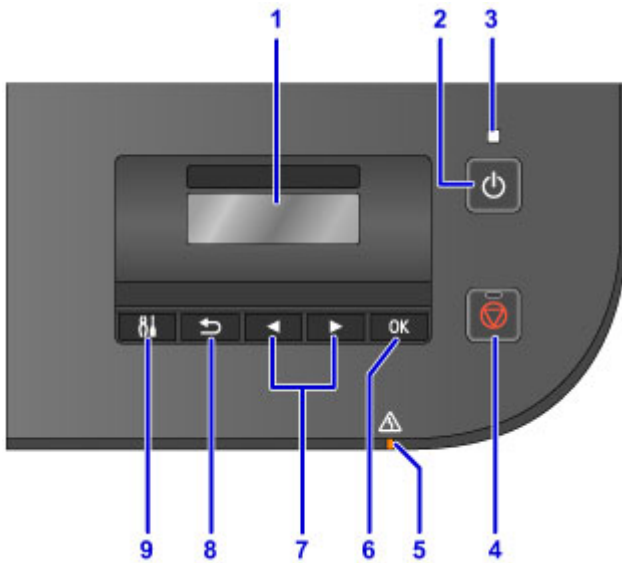

(1) LCD (Liquid Crystal Display)

Displays messages, menu items, and operating status.

(2) ON button

Turns the printer on or off.

■ [Turning the Printer On and Off](#)

(3) POWER lamp

Remains lit after flashing when the printer is turned on.

(4) Stop button

Cancels print jobs in progress.

(5) Alarm lamp

Lights up or flashes in case of errors.

(6) OK button

Confirms your selection of menu or setting items. Also used to resolve errors.

(7) ◀ and ▶ buttons

Used to select menu or setting items.

■ [LCD and Operation Panel](#)

(8) Back button

Returns to the previous screen.

(9) Setup button

Displays the **Setup menu** screen. From this menu, you can perform printer maintenance and adjust printer settings.

Power Supply

- ▶ **Confirming that the Power Is On**
- ▶ **Turning the Printer On and Off**
- ▶ **Checking the Power Plug/Power Cord**
- ▶ **Unplugging the Printer**

Confirming that the Power Is On

The **POWER** lamp is lit when the printer is on.

Even if the LCD is off, as long as the **POWER** lamp is lit, the printer is on.



▶▶▶ Note

- After you turn the printer on, it requires a warm-up period of about 20 seconds before any operations. Wait until the standby screen is displayed.
- The LCD turns off automatically after about 5 minutes of inactivity. To activate the display again, press a button other than the **ON** button on the operation panel, or perform a printing operation.

Turning the Printer On and Off

Turning the printer on

1. Press the **ON** button to turn the printer on.

The **POWER** lamp flashes and then remains lit.

- [Confirming that the Power Is On](#)



►► Note

- After you turn the printer on, it requires a warm-up period of about 20 seconds before any operations. Wait until the standby screen is displayed.
- If the **Alarm** lamp lights up or flashes and an error message appears on the LCD, see [Message Appears](#).
- You can set the printer to turn on automatically when printing is started from a printer connected by USB or network. This feature is disabled by default.

From your printer

- [Turning on/off Printer Automatically](#)

From your computer

- [Managing the Printer Power](#) (Windows)
- [Managing the Printer Power](#) (Mac OS)

Turning the printer off

1. Press the **ON** button to turn the printer off.

Once the **POWER** lamp stops flashing, the printer goes off.



►► Important

- Before [unplugging the printer](#) after turning it off, confirm that the **POWER** lamp is off.

»» Note

- You can set the printer to turn off automatically after a specified period when no print jobs are received from a computer. This feature is enabled by default.

From your printer

- [Turning on/off Printer Automatically](#)

From your computer

- [Managing the Printer Power](#) (Windows)
- [Managing the Printer Power](#) (Mac OS)

Checking the Power Plug/Power Cord

Disconnect the power plug/power cord and check it once a month to ensure that it is not affected by these problems.

- Excessively hot
- Corroded
- Bent
- Worn
- Cracked or split

Caution

- If the power plug/power cord case is affected by these or other problems, [unplug the printer](#) and request service. Continuing to use the printer with any of these problems may cause a fire or electric shock.

Unplugging the Printer

Always follow these steps when unplugging the printer.

▶▶▶ Important

- Unplug the printer only after pressing the **ON** button and confirming that the **POWER** lamp is off. Unplugging the printer while the **POWER** lamp is still on may cause the print head to dry out or become clogged, which may affect print quality.

1. Press the **ON** button to turn the printer off.



2. Confirm that the **POWER** lamp is off.



3. Unplug the printer.

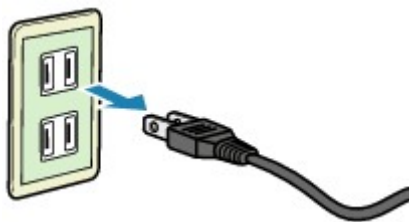

Power cord specifications vary by region.

LCD and Operation Panel

Press the **Setup** button (A) on the operation panel to display the **Setup menu** screen, from which you can select a variety of functions and settings.

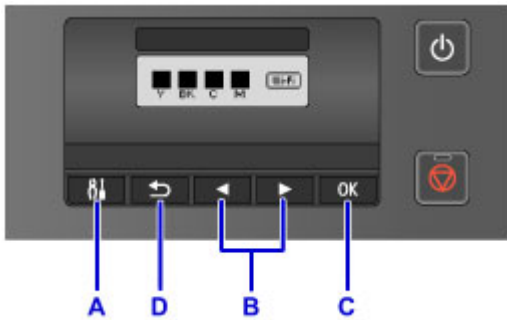

Selecting Items in Menus or Settings

On the menu or settings screen, use the ◀ or ▶ button (B) to select an item or option, and then press the **OK** button (C) to continue.

To return to the previous screen, press the **Back** button (D).

Changing auto cassette switching



On the standby screen, press the **Setup** button (A).

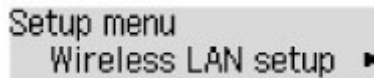

Use the ◀ or ▶ button (B) to select **Device settings**.

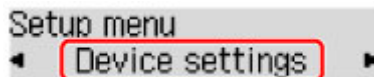

Press the **OK** button (C).

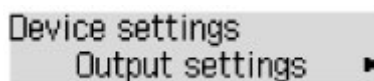

Use the ◀ or ▶ button (B) to select **Cassette settings**.

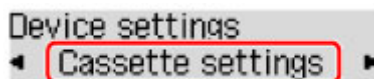

Press the **OK** button (C).

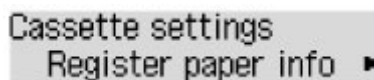

Use the ◀ or ▶ button (B) to select **Auto feed switch**.

Cassette settings
◀ Auto feed switch

Press the **OK** button (C).

Auto feed switch
*ON ▶

Use the ◀ or ▶ button (B) to change the setting, and then press the **OK** button (C).

Changing Settings

- ▶ **Changing Printer Settings from Your Computer (Windows)**
- ▶ **Changing Printer Settings from Your Computer (Mac OS)**
- ▶ **Changing Settings from Operation Panel**
- ▶ **Changing Printer's Setting Using Web Browser**

Changing Printer Settings from Your Computer (Windows)

- **Changing the Print Options**
- **Registering a Frequently Used Printing Profile**
- **Managing the Printer Power**
- **Reducing the Printer Noise**
- **Changing the Printer Operation Mode**

Changing the Print Options

You can change the detailed printer driver settings for print data that is sent from an application software. Check this check box if part of the image data is cut off, the paper source during printing differs from the driver settings, or printing fails.

The procedure for changing the print options is as follows:

1. Open the [printer driver setup window](#)
2. Click **Print Options...** on the **Page Setup** tab

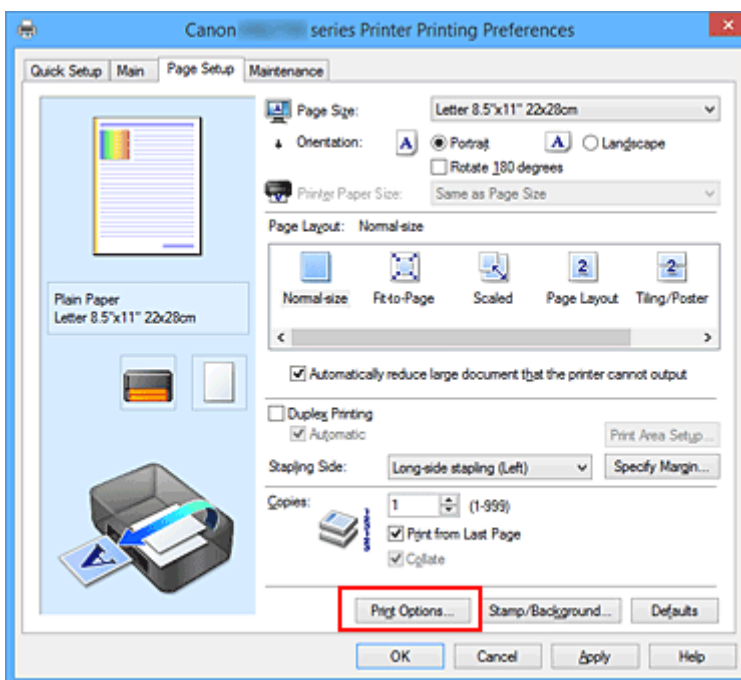

The **Print Options** dialog box opens.

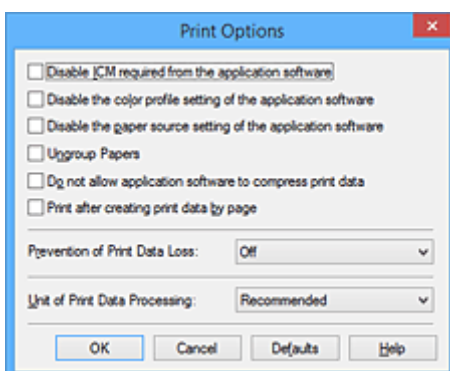

►►► Note

- When you use the XPS printer driver, the functions available to you are different.

3. Change the individual settings

If necessary, change the setting of each item, and then click **OK**.

The **Page Setup** tab is displayed again.

Registering a Frequently Used Printing Profile

You can register the frequently used printing profile to **Commonly Used Settings** on the **Quick Setup** tab. Unnecessary printing profiles can be deleted at any time.

The procedure for registering a printing profile is as follows:

Registering a Printing Profile

1. Open the [printer driver setup window](#)

2. Set the necessary items

From **Commonly Used Settings** on the **Quick Setup** tab, select the printing profile to be used and if necessary, change the settings after **Additional Features**.

You can also register necessary items on the **Main** and **Page Setup** tabs.

3. Click **Save...**

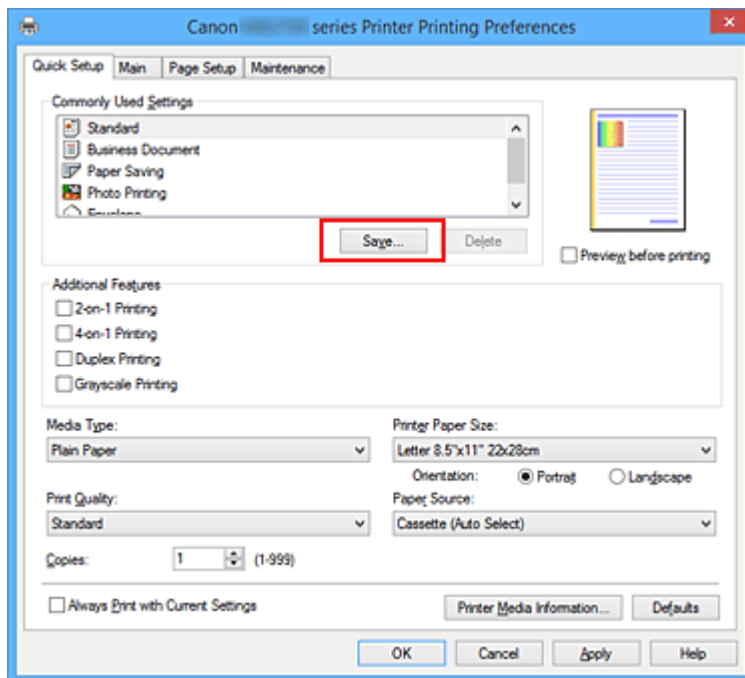

The **Save Commonly Used Settings** dialog box opens.



4. Save the settings

Enter a name in the **Name** field. If necessary, click **Options...**, set the items, and then click **OK**.

In the **Save Commonly Used Settings** dialog box, click **OK** to save the print settings and return to the **Quick Setup** tab.

The name and icon are displayed in **Commonly Used Settings**.

▶▶▶ Important

- To save the page size, orientation, and number of copies that was set in each sheet, click **Options...**, and check each item.

▶▶▶ Note

- When you re-install the printer driver or upgrade the printer driver version, the print settings that are already registered will be deleted from **Commonly Used Settings**. Registered print settings cannot be saved and preserved. If a profile is deleted, register the print settings again.

Deleting Unnecessary Printing Profile

1. Select the printing profile to be deleted

Select the printing profile you want to delete from the **Commonly Used Settings** list on the **Quick Setup** tab.

2. Delete the printing profile

Click **Delete**. When the confirmation message appears, click **OK**.

The selected printing profile is deleted from the **Commonly Used Settings** list.

▶▶▶ Note

- Printing profiles that are registered in the initial settings cannot be deleted.

Managing the Printer Power

This function allows you to manage the printer power from the printer driver.

The procedure for managing the printer power is as follows:



Power Off

The **Power Off** function turns off the printer. When you use this function, you will not be able to turn the printer on from the printer driver.

1. Open the [printer driver setup window](#)
2. Execute power off

Click **Power Off** on the **Maintenance** tab. When the confirmation message appears, click **OK**.

The printer power switches off, and the **Maintenance** tab is displayed again.



Auto Power

Auto Power allows you to set **Auto Power On** and **Auto Power Off**.

The **Auto Power On** function automatically turns on the printer when data is received.

The **Auto Power Off** function automatically turns off the printer when there are no operations from the printer driver or the printer for a specified period of time.

1. Open the [printer driver setup window](#)
2. Make sure that the printer is on and then click **Auto Power** on the **Maintenance** tab

The **Auto Power Settings** dialog box opens.

▶▶▶ Note

- If the printer is off or if communication between the printer and the computer is disabled, an error message may appear because the computer cannot collect the printer status. If this happens, click **OK** to display the most recent settings specified on your computer.

3. If necessary, complete the following settings:

Auto Power On

Specifying **Enable** from the list will turn the printer on upon receipt of print data.

Auto Power Off

Specify the time from the list. When this time lapses without any operations from the printer driver or the printer, the printer is turned off automatically.

4. Apply the settings

Click **OK**. When the confirmation message appears, click **OK**.

The **Maintenance** tab is displayed again.

The setting is enabled after this. When you want to disable this function, select **Disable** from the list according to the same procedure.

▶▶ Note

- When the printer is turned off, the Canon IJ Status Monitor message varies depending on the **Auto Power On** setting.
When the setting is **Enable**, "Printer is standing by" is displayed. When the setting is **Disable**, "Printer is offline" is displayed.

Reducing the Printer Noise

The silent function allows you to reduce the operating noise of this printer. Select when you wish to reduce the operating noise of the printer at night, etc.

Using this function may lower the print speed.

The procedure for using the quiet mode is as follows:



Quiet Settings

1. Open the [printer driver setup window](#)
2. Click **Quiet Settings** on the **Maintenance** tab

The **Quiet Settings** dialog box opens.

▶▶▶ Note

- If the printer is off or if communication between the printer and the computer is disabled, an error message may appear because the computer cannot collect the printer status.

3. Set the quiet mode

If necessary, specify one of the following items:

Do not use quiet mode

Select this option when you wish to use the printer with volume of normal operating noise.

Always use quiet mode

Select this option when you wish to reduce the operating noise of the printer.

Use quiet mode during specified hours

Select this option when you wish to reduce the operating noise of the printer during a specified period of time.

Set the **Start time** and the **End time** of the quiet mode you wish to be activated. If both are set to the same time, the quiet mode will not function.

▶▶▶ Important

- You can set the quiet mode from the printer or the printer driver.
No matter how you use to set the quiet mode, the mode is applied when you perform operations from the printer or printing from the computer.

4. Apply the settings

Make sure that the printer is on and click **OK**.

Click **OK** when the confirmation message appears.

The settings are enabled hereafter.

»» Note

- The effects of the quiet mode may be less depending on the paper source and the print quality settings.

Changing the Printer Operation Mode

If necessary, switch between various modes of printer operation.

The procedure for configuring **Custom Settings** is as follows:



Custom Settings

1. Open the [printer driver setup window](#)
2. Make sure that the printer is on, and then click **Custom Settings** on the **Maintenance** tab

The **Custom Settings** dialog box opens.

▶▶▶ Note

- If the printer is off or if communication between the printer and the computer is disabled, an error message may appear because the computer cannot collect the printer status. If this happens, click **OK** to display the most recent settings specified on your computer.

3. If necessary, complete the following settings:

Prevent paper abrasion

The printer can increase the gap between the print head and the paper during high-density printing to prevent paper abrasion.

Check this check box to prevent paper abrasion.

Align heads manually

Usually, the **Print Head Alignment** function on the **Maintenance** tab is set to automatic head alignment, but you can change it to manual head alignment.

If the printing results of automatic print head alignment are not satisfactory, [perform manual head alignment](#).

Check this check box to perform the manual head alignment. Uncheck this check box to perform the automatic head alignment.

Rotate 90 degrees left when orientation is [Landscape]

On the **Page Setup** tab, you can change the rotation direction of the **Landscape** in the **Orientation**.

To rotate the print data 90 degrees to the left during printing, select this item. To rotate the print data 90 degrees to the right during printing, clear this item.

▶▶▶ Important

- Do not change this setting while the print job is displayed in the print wait list. Otherwise, characters may be omitted or the layout may become corrupt.

Don't detect mismatch of paper settings when printing from computer

When you print documents from your computer and the paper settings on the printer driver and the cassette paper information registered on the printer do not match, this setting disables the

message display and allows you to continue printing.

To disable detection of paper setting mismatches, select this check box.

Ink Drying Wait Time

You can set the length of the printer rest time until printing of the next page begins. Moving the slider to the right increases the pause time, and moving the slider to the left decreases the time.

If the paper gets stained because the next page is ejected before the ink on the printed page dries, increase the ink drying wait time.

Reducing the ink drying wait time speeds up printing.

4. Apply the settings

Click **OK** and when the confirmation message appears, click **OK**.

The printer operates with the modified settings hereafter.

Changing Settings from Operation Panel

- ▶ **Changing Settings from Operation Panel**
- ▶ **Setting Items on Operation Panel**
- ▶ **Output settings**
- ▶ **LAN settings**
- ▶ **Dev. user settings**
- ▶ **Firmware update**
- ▶ **Cassette settings**
- ▶ **Reset setting**
- ▶ **Web service setup**
- ▶ **System information**
- ▶ **Quiet setting**
- ▶ **Turning on/off Printer Automatically**

Changing Settings from Operation Panel

This section describes the procedure to change the settings in the **Device settings** screen, taking the steps to specify **Prevent abrasion** as an example.

▶▶▶ Note

- The * (asterisk) on the LCD indicates the current setting.

1. [Make sure printer is turned on.](#)
2. Press **Setup** button.
The **Setup menu** screen is displayed.
3. Select **Device settings** and press **OK** button.
The **Device settings** screen is displayed.
4. Select setting item and press **OK** button.

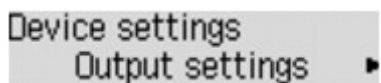

Device settings
Output settings ▶

The setting screen for the selected item is displayed.

5. Select menu and press **OK** button.

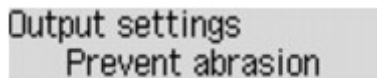

Output settings
Prevent abrasion

6. Select setting item and press **OK** button.

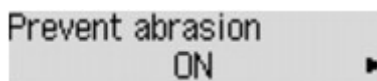

Prevent abrasion
ON ▶

For more on setting items on the operation panel:

- [Setting Items on Operation Panel](#)

Setting Items on Operation Panel

Items for Printer

- [Dev. user settings](#)
- [Web service setup](#)
- [Turning on/off Printer Automatically](#)
- [Quiet setting](#)

Items for Paper/Printing

- [Output settings](#)
- [Cassette settings](#)
- [Paper Settings](#)

Items for Maintenance/Management

- [System information](#)
- [Firmware update](#)
- [LAN settings](#)
- [Reset setting](#)

Output settings

Select this setting item from **Device settings** on **Setup menu**.

- **Prevent abrasion**

Use this setting only if the print surface becomes smudged.

»» Important

- Be sure to set this back to **OFF** after printing since it may result in lower printing speed or lower print quality.

LAN settings

Select this setting item from **Device settings** on **Setup menu**.

- **Change LAN**

Enables either wireless LAN, wired LAN, or direct connection. You can also disable all.

- **Wireless LAN setup**

Selects the setup method for wireless LAN connection.

▶▶▶ Note

- You can also enter this setting menu by selecting **Wireless LAN setup** from the **Setup menu** screen.

- **Cableless setup**

Select if you specify the settings of the access point information to the printer directly from a device (such as a smartphone) without operating the wireless router. Follow the on-screen instructions of the connecting device for the setup procedure.

- **WPS (Push button)**

Select when you perform settings for wireless LAN using a wireless router supporting a Wi-Fi Protected Setup (WPS) push button method. Follow the on-screen instructions during setup.

- **Other setup**

- **WPS (PIN code)**

Select when you perform settings for wireless LAN using a wireless router supporting a Wi-Fi Protected Setup (WPS) PIN code method. Follow the on-screen instructions during setup.

- **Direct connection**

Setting items are available when you connect a wireless communication device such as a smartphone or tablet to the printer.

▶▶▶ Important

- You can select these setting items only when **Yes** is selected for **Direct connection** on **Change LAN**.

- **Update SSID/PW**

Selecting **Yes** updates the identifier (SSID) and password for direct connection.

- **Confirm request**

Selecting **Yes** displays the confirmation screen when a Wi-Fi Direct compatible device is connecting the printer.

- [Using Printer with Direct Connection](#)

- **Print LAN details**

You can print out the network settings of the printer such as its IP address and SSID.

For more information on the printer's network setting is printed out:

▶▶▶ **Important**

- The network settings printout contains important information about your network. Handle it with care.

• **Other settings**

▶▶▶ **Important**

- You cannot select the items below when **LAN inactive** is selected for **Change LAN**.

- **TCP/IP settings**

Performs IPv4 or IPv6 setting.

- **WSD setting**

Setting items when you use WSD (one of the network protocols supported in Windows 10, Windows 8.1, Windows 8, Windows 7, and Windows Vista).

- **Enable/disable WSD**

- Selects whether WSD is enabled or disabled.

▶▶▶ **Note**

- When this setting is enabled, the printer icon is displayed on the Network Explorer in Windows 10, Windows 8.1, Windows 8, Windows 7, and Windows Vista.

- **Optimize WSD-In**

- Selecting **Active** allows you to receive the WSD printing data faster.

- **Timeout setting**

- Specifies the timeout length.

- **Bonjour settings**

Setting items for LAN using Bonjour for Mac OS.

- **Enab./disab. Bonjour**

- Selecting **Active** allows you to use Bonjour to perform the network settings.

- **LPR setting**

Enables/disables the LPR setting.

- **RAW protocol**

Enables/disables RAW printing.

- **LLMNR**

Enables/disables LLMNR (Link-Local Multicast Name Resolution). Selecting **Active** allows the printer to detect printer's IP address from the printer name without a DNS server.

- **DRX setting**

Enables discontinuous reception when using wired LAN. It allows you to save electricity.

- **Wired LAN**

Selecting **Active** allows you to enable discontinuous reception when using wired LAN.

▶▶ Note

- Depending on the router you are using, discontinuous reception may not be enabled even though **Active** is selected.
- Discontinuous reception is enabled only while the printer is on standby. (The LCD is in the screen saver mode.)

Dev. user settings

Select this setting item from **Device settings** on **Setup menu**.

- **Date/time setting**

Sets the current date and time.

- **DST setting**

Enables/disables the summer time setting. If you select **ON**, you can select additional sub-settings. This setting may not be available depending on the country or region of purchase.

- **Start date/time**

Sets the date and time that summer time starts.

Set month: Specify the month.

Set week: Specify the week.

Set day of week: Specify the day of the week.

Set shift time: Specify the hour (24-hour clock).

- **End date/time**

Sets the date and time that summer time ends.

Set month: Specify the month.

Set week: Specify the week.

Set day of week: Specify the day of the week.

Set shift time: Specify the hour (24-hour clock).

- **Time zone**

Specifies the time zone according to a country or region you live in.

Specifying the time zone allows you to display the correct time and date an e-mail was sent on your mail software.

For more on the time zone for each country or region:

■ [Timezone List](#)

- **Language selection**

Changes the language for LCD messages and menus.

Japanese / English / German / French / Italian / Spanish / Dutch / Portuguese / Norwegian / Swedish / Danish / Finnish / Russian / Ukrainian / Polish / Czech / Slovak / Hungarian / Slovene / Croatian / Romanian / Bulgarian / Turkish / Greek / Estonian / Latvian / Lithuanian / Simplified Chinese / Traditional Chinese / Korean / Indonesian / Vietnamese

- **Key repeat**

Enables/Disables continuous input by pressing and holding down the ◀▶ button when selecting a setting menu or setting item.

- **Device info sending**

Selects whether you will send the printer usage information to Canon. The information sent to Canon will be utilized to develop better products. Select **ON** to send the printer usage information to Canon.

Timezone List

Time zone	Country or region
(UTC-12:00)	Baker Island, Howland Island
(UTC-11:00)	American Samoa, Niue
(UTC-10:00)	Hawaii, Western area of Aleutian Islands
(UTC-9:00)	Alaska
(UTC-8:00)	US/Canada/Mexico (Pacific Time)
(UTC-7:00)	US/Canada/Mexico (Mountain Time)
(UTC-6:00)	US/Canada/Mexico (Central Time)
(UTC-5:00)	US/Canada/Mexico (Eastern Time), Cuba, Peru
(UTC-4:30)	Venezuela
(UTC-4:00)	Canada (Atlantic Time), Most areas of Lesser Antilles, Brazil (Amazon Time), Chile
(UTC-3:30)	Canada (Newfoundland)
(UTC-3:00)	Brazil (Brasilia time), Argentina, Greenland
(UTC-2:00)	Brazil (Fernando de Noronha)
(UTC-1:00)	Azores, Cape Verde
(UTC+00:00)	United Kingdom, Ireland, Portugal, Iceland, Morocco (Western Africa), Ghana
(UTC+1:00)	Central European Time (France, Germany), West Africa Time (Nigeria, Congo)
(UTC+2:00)	Eastern European Time (Finland, Greece), Central Africa Time, South Africa
(UTC+3:00)	Russia (Kaliningrad), Ukraine, Belarus, Saudi Arabia, East Africa Time
(UTC+3:30)	Iran
(UTC+4:00)	Russia (Moscow), Azerbaijan, Georgia, United Arab Emirates, Mauritius
(UTC+4:30)	Afghanistan
(UTC+5:00)	Pakistan
(UTC+5:30)	India
(UTC+5:45)	Nepal
(UTC+6:00)	Russia (Yekaterinburg), Kazakhstan, Bangladesh
(UTC+6:30)	Myanmar, Cocos Islands
(UTC+7:00)	Russia (Omsk), Mongolia, Thailand, Vietnam, Jakarta
(UTC+8:00)	Russia (Krasnoyarsk), China, Mongolia, Malaysia, Australia (Western Australia)
(UTC+8:45)	Australia (Eucla)
(UTC+9:00)	Russia (Irkutsk), South Korea, Japan, Palau
(UTC+9:30)	Australia (Northern Territory, South Australia)
(UTC+10:00)	Russia (Yakutsk), Guam, Australian Eastern Standard Time
(UTC+10:30)	Australia (Lord Howe Island)

(UTC+11:00)	Russia (Vladivostok), Solomon Islands, New Caledonia
(UTC+12:00)	Russia (Magadan), New Zealand, Fiji, Kiribati (Gilbert Islands)
(UTC+12:45)	New Zealand (Chatham Island)
(UTC+13:00)	Tonga, Kiribati (Phoenix Islands), Samoa (From 2011/12/31), Tokelau (From 2011/12/31)
(UTC+14:00)	Kiribati (Line Islands)

Firmware update

Select this setting item from **Device settings** on **Setup menu**.

You can update the firmware of the printer, check the firmware version, or perform settings of a notification screen.

▶▶▶ Note

- Only **Current version** is available when LAN is disabled or while you are using the printer with direct connection.

• **Install update**

Performs the firmware update of the printer.

▶▶▶ Important

- When you use this function, make sure the printer is connected to the Internet.

▶▶▶ Note

- If the firmware update is not complete, check the following and take an appropriate action.
 - When using wired LAN, make sure the printer is connected to the computer with a LAN cable properly.
 - Check the network settings such as a router.
 - If **Cannot connect to the server; try again** is displayed on the LCD, press the **OK** button and try again after a while.

• **Current version**

You can check the current firmware version.

• **Update notification**

When **Yes** is selected and the firmware update is available, the screen to inform you of the firmware update is displayed on the LCD.

Cassette settings

Select this setting item from **Device settings** on **Setup menu**.

By registering the paper size and the media type loaded in the cassette, you can prevent the printer from misprinting by displaying the message before printing starts when the paper size or the media type of the loaded paper differs from the print settings. In addition, you can allow the printer to switch the paper source automatically when a cassette runs out of paper.

- **Register paper info**

Registers the paper size and the media type you load in the cassette.

▶▶▶ Note

- For details on the combination of paper settings you can specify by the printer driver or on the LCD:
 - For Windows:
 - [Paper Settings on the Printer Driver and the Printer \(Media Type\)](#)
 - [Paper Settings on the Printer Driver and the Printer \(Paper Size\)](#)
 - For Mac OS:
 - Paper Settings on the Printer Driver and the Printer (Media Type)
 - Paper Settings on the Printer Driver and the Printer (Paper Size)

- **Det. paper mismatch**

If you select **ON**, the printer detects whether the paper size and the media type are the same as those registered in **Register paper info**. If printing starts with the settings that do not match, an error message is displayed on the LCD.

- **Detect reinsertion**

If you select **ON**, the printer detects the cassette is reinserted. When the **Register paper info** screen is displayed, register the paper size and the media type.

- **Auto feed switch**

If you select **ON**, the printer switches the paper source automatically when a cassette runs out of paper. Load A4, Letter, or Legal sized plain paper in both of the cassettes to activate this function.

Reset setting

Select this setting item from **Device settings** on **Setup menu**.

Returns all settings you made to the printer back to the default. However, some data may not be changed, depending on the current usage state of your printer.

- **Web service setup**

Deletes IJ Cloud Printing Center and Google Cloud Print registrations.

- **LAN settings**

Returns the LAN settings other than the administrator password back to the default.

- **Setting data**

Returns the settings such as the paper size, media type, or other setting items back to the default. The LAN settings are not returned back to the default.

- **Device info sending**

Applies the setting not to send the device information to Canon.

- **All data**

Reverts all settings you made to the machine/printer back to default.

▶▶▶ Note

- You cannot set the following setting items back to the default:
 - The language displayed on the LCD
 - The current position of the print head
 - CSR (Certificate Signing Request) for encryption method (SSL/TLS) setting
- **ON** is selected for **Device info sending** on **Dev. user settings** after you have reset the setting to send device information. However, the printer does not send device information. Select **OFF** and press the **OK** button to disable the function to send device information.

Web service setup

Select this setting item from **Setup menu**.

The following setting items are available.

- **GoogleCloudPrint**

Registers/Deletes the printer to/from Google Cloud Print.

- **IJCloudPrintingCtr**

Registers/Deletes the printer to/from Canon Inkjet Cloud Printing Center.

System information

Select this setting item from **Setup menu**.

- **Current version**

Displays the current firmware version.

- **Printer name**

Displays the printer name currently specified.

- **Serial number**

Displays the printer serial number.

Quiet setting

Enable this function on the printer if you want to reduce the operating noise, such as when printing at night.

Follow the procedure below to perform setting.

1. [Make sure printer is turned on.](#)
2. Press **Setup** button.
The **Setup menu** screen is displayed.
3. Select **Quiet setting** and press **OK** button.

4. Select **ON** and press **OK** button.

The LCD returns to the **Setup menu** screen.

You can reduce the operating noise while printing is in progress.

▶▶▶ Important

- Operating speed is reduced compared to when **OFF** is selected.
- This function may not be so effective depending on the printer's setting. Furthermore, certain noise, such as when the printer is preparing for printing, is not reduced.

▶▶▶ Note

- You can set the quiet mode from the operation panel of the printer or the printer driver. No matter how you set the quiet mode, the mode is applied when you perform operations from the operation panel of the printer or printing from the computer.

Turning on/off Printer Automatically

You can enable the printer to turn on/off automatically considering the environment

■ [Turning on Printer Automatically](#)

■ [Turning off Printer Automatically](#)

Turning on Printer Automatically

You can enable the printer to turn on automatically when printing data is sent to the printer.

1. [Make sure printer is turned on.](#)
2. Press **Setup** button.
The **Setup menu** screen is displayed.
3. Select **ECO (power on/off)** and press **OK** button.
4. Select **Auto power on** and press **OK** button.
5. Select **ON** and press **OK** button.

▶▶▶ Note

- You can select whether you turn the printer on automatically from the operation panel of the printer or the printer driver. No matter how you set the mode, the mode is applied when printing data is sent to the printer.

Turning off Printer Automatically

You can enable the printer to turn off automatically when no operation is made or no printing data is sent to the printer for a specified period of time.

1. [Make sure printer is turned on.](#)
2. Press **Setup** button.
The **Setup menu** screen is displayed.
3. Select **ECO (power on/off)** and press **OK** button.
4. Select **Auto power off** and press **OK** button.
5. Select time and press **OK** button.

»» Note

- You can select whether you turn off the printer automatically from the operation panel of the printer or the printer driver.

Changing Printer's Setting Using Web Browser

- ▶ **Changing Settings Using Web Browser**
- ▶ **Changeable Setting Items Using Web Browser**
- ▶ **Setting Password**
- ▶ **Setting Mail Server**
- ▶ **Receiving Printer Status by E-mail**

Changing Settings Using Web Browser

You can check the printer status and change the printer settings using the web browser on your smartphone, tablet, or computer.

To check the printer status and to change the printer settings, display "Remote UI" on the web browser.

▶▶▶ Note

- Remote UI is a software that enables you to perform operations, which are usually performed on the printer's operation panel, using a Web browser over a network.

LAN connection with the printer is required to use Remote UI.

- You can use Remote UI on the following OS and the web browser.

- iOS device

OS: iOS 7.0 or later

Web browser: iOS standard Web browser (Mobile Safari)

- Android device

OS: Android 4.0 or later

Web browser: Android standard Web browser (Browser or Chrome)

- Mac OS device

OS: Mac OS X v.10.6 or later

Web browser: Safari 5.1 or later

- Windows device

OS: Windows Vista SP2 or later

Web browser: Internet Explorer 9 or later, Google Chrome 41.0.2272.118m or later, Mozilla Firefox 37.0.1 or later

1. [Make sure printer is turned on.](#)

2. Check printer's IP address.

Print the network setting information to check the printer's IP address by following the steps below.

1. [Load 3 sheets of A4 or Letter-sized plain paper.](#)

2. Press **Setup** button.

The **Setup menu** screen is displayed.

3. Select **Device settings** and press **OK** button.

The **Device settings** screen is displayed.

4. Select **LAN settings** and press **OK** button.

5. Select **Print LAN details** and press **OK** button.

The printer starts printing the network setting information.

6. Check "IP Address" column on network setting information sheet.

▶▶▶ Note

- If you display Remote UI for the first time on your smartphone, tablet, or computer, the network setting information will be required in a subsequent operation.

3. Open web browser on your smartphone, tablet, or computer and enter IP address.

Enter as following in the URL field of the web browser.

http://XXX.XX.X.XXX

Enter the IP address in "XXX.XX.X.XXX".

When you access, "Remote UI" will be displayed on the web browser on your smartphone, tablet, or computer.

4. If you display Remote UI for the first time on your smartphone, tablet, or computer, select **For secure communication**.

Download the root certificate, and then register it.

■ [Registering Printer's Root Certificate to Web Browser](#)

▶▶▶ Note

- Once you register the root certificate to the web browser on your smartphone, tablet, or computer, this step is not necessary after the next time.
If **All data** in **Reset setting** was performed from the printer's operation panel, download the root certificate again, and then register it.
- If the root certificate is not registered, a message to warn you that the secure connection is not guaranteed may appear.

5. Select **Log on**.

The password authentication screen appears.

▶▶▶ Note

- When the standard user mode is enabled, choose either administrator mode or standard user mode to log on.
- After choosing a mode and selecting **Log on**, the password authentication screen of each mode appears.

6. Enter password.

When the password authentication is complete, the menus that can be utilized are displayed on the web browser.

▶▶▶ Important

- The password is set at the time of purchase. The password is the printer serial number. The printer serial number is printed on the sticker attached on the printer. It consists of 9 alphanumeric characters (four alphabets followed by five numbers).

For details on setting password, see [Setting Password](#).

7. Check printer status and change printer settings.

For changeable setting items, see below.

■ [Changeable Setting Items Using Web Browser](#)

8. When you finish checking printer status and changing printer settings, select **Log off**.

9. Close web browser.

Registering Printer's Root Certificate to Web Browser

If the printer's root certificate has not been registered to the web browser, a message to warn you that the secure connection is not guaranteed may appear.

When you display Remote UI for the first time on your smartphone, tablet, or computer, download the root certificate, and then register it to the web browser. The secure connection will be confirmed and a message will not appear.

How to register the root certificate varies depending on the web browser.

- [For Internet Explorer](#)
- [For Safari](#)
- [For Chrome on Android](#)
- [For Mobile Safari on iOS](#)

For other web browser, refer to each help.

▶▶▶ Important

- Make sure that you have accessed to the printer IP address correctly by checking the URL field of the web browser before registering the root certificate.

For Internet Explorer

1. Select **Download** on Remote UI.

Downloading the root certificate is started.

2. If confirmation screen appears, select **Open**.

Certificate screen is displayed.

▶▶▶ Note

- To save the certificate file to your device and register it, select **Save**. Select **Internet options** from **Tool** menu of Internet Explorer, register the root certificate from **Certificates** on **Content** sheet.

3. Select **Install Certificate**.

Certificate Import Wizard screen is displayed.

4. Select **Next**.

5. Select **Place all certificates in the following store**.

6. Select **Browse**.

Select Certificate Store screen is displayed.

7. Select **Trusted Root Certification Authorities** and **OK**.

8. Select **Next** on **Certificate Import Wizard** screen.
9. If **Completing the Certificate Import Wizard** appears, select **Finish**.
Security Warning screen is displayed.
10. Make sure that thumbprint on **Security Warning** screen matches printer's thumbprint.
For printer's thumbprint, check "Certificate fingerprint(SHA-1)" column or "Certificate fingerprint(SHA-256)" column on the network information that was printed when you check the printer's IP address.
11. If thumbprint on **Security Warning** screen matches printer's thumbprint, select **Yes**.
12. Select **Yes** on **Certificate Import Wizard** screen.
The root certificate registration is completed.

For Safari

1. Select **Download** on Remote UI.
Downloading the root certificate is started.
2. Open the download file.
Add Certificates screen is displayed.
3. Select **Add**.
4. Make sure that thumbprint of certificate detail information matches printer's thumbprint.
For printer's thumbprint, check "Certificate fingerprint(SHA-1)" column or "Certificate fingerprint(SHA-256)" column on the network information that was printed when you check the printer's IP address.
5. If thumbprint of certificate detail information matches printer's thumbprint, select **Always Trust**.
The root certificate registration is completed.

Note

- If a password is set on your device, entering a password may be required.

For Chrome on Android

1. Select **Download** on Remote UI.

Downloading the root certificate is started and then **Downloading Certificate** screen is displayed.

2. Specify certificate name, and then select **OK**.

The root certificate registration is completed.

▶▶▶ Note

- If PIN or password is not set as security type, the attention screen may appear. Select **OK**, and then set the security type to PIN or password.
- If the message to warn you that the secure connection is not guaranteed appears when you select **Log on** on Remote UI after registering the root certificate, restart the web browser. The message will not appear on the web browser.

After Root Certificate Registration

We recommend that you make sure that the correct root certificate has been registered.

Depending on the Android device, a warning may appear because the root certificate that contains the authentication information was registered.

To make sure that the correct root certificate has been registered, make sure that thumbprint of certificate information matches printer's thumbprint. Follow the steps below.

▶▶▶ Note

- Some Android devices cannot check the thumbprint of a registered root certificate.

1. From **Settings** menu on your device, select **Security, Trust credentials**, and **USER**.
The list of downloaded certificates is displayed.
2. Select downloaded certificate.
The certificate information is displayed.
3. Make sure that thumbprint of certificate information screen matches printer's thumbprint.
For printer's thumbprint, check "Certificate fingerprint(SHA-1)" column or "Certificate fingerprint(SHA-256)" column on the network information that was printed when you check the printer's IP address.
4. If thumbprint of certificate information matches printer's thumbprint, select **OK**.
Confirmation of the root certificate is completed.

For Mobile Safari on iOS

1. Select **Download** on Remote UI.
Downloading the root certificate is started and then **Install Profile** screen is displayed.
2. Select **Install**.
Warning screen is displayed.

»» Note

- If a password is set on your device, entering a password may be required.

3. Select **Install**.

4. Select **Install** on displayed dialog.

The root certificate registration is completed.

Changeable Setting Items Using Web Browser

►► Note

- The items described here and the items displayed in the web browser may differ in display order.
- The item which can be used is different in administrator mode or in standard user mode.

Items for Security

Security (Item for administrator)

This function allows you to specify the password, the standard user mode settings, the operation restrictions, and SSL/TLS settings of certificate for encrypted communication.

For details on setting password, see [Setting Password](#).

Items for Maintenance/Management

Utilities

This function allows you to set and execute the printer utility functions such as cleaning.

System info and LAN settings

This function allows you to check the system information and to change the LAN settings.

Using **IP filtering** in **Other settings** in **LAN settings**, you can permit or refuse the connection of a specific IP address for IPv4 address or IPv6 address.

Using **SNMP settings** in **Other settings** in **LAN settings**, you can specify the SNMP and MIB setting to management the printer via a network.

►► Important

- If you has refused the IP address of administrator's device using **IP filtering** by mistake, reset LAN settings of the printer.

For resetting LAN settings, see [Reset setting](#).

►► Note

- Some of the menu is available only when you logged on in administrator mode.

Firmware update (Item for administrator)

This function allows you to update the firmware and check version information.

Language selection (Item for administrator)

This function allows you to change the language on the display.

Items for Printer

Device settings

This function allows you to change the printer settings such as the quiet setting, the energy saving settings, and the print settings.

Additionally, this function allows you to change the mail settings and to receive the printer status information such as the remaining ink level and the error.

- [Setting Mail Server](#)

■ [Receiving Printer Status by E-mail](#)

▶▶▶ **Note**

- Some of the menu is available only when you logged on in administrator mode.

AirPrint settings

This function allows you to specify the AirPrint settings, such as position information.

Web service connection setup (Item for administrator)

This function allows you to register to Google Cloud Print or IJ Cloud Printing Center, or delete a registration.

Other Items

Printer status

This function displays printer information such as the remaining ink amount, the status, and detailed error information.

You can also connect to the ink purchase site or support page, and use Web Services.

Records of use

This function displays the total number of printing.

Manual (Online)

This function displays the Online Manual.

Setting Password

Each of passwords for administrator and standard user can be set.

When logging on with password for administrator, all settings can be changed.

When logging on with password for standard user, some of the settings can be changed.

When logging on with password for administrator, you can restrict the function for standard user.

■ [Setting Administrator Password](#)

■ [Setting Standard User Password](#)

▶▶▶ Note

- Password can be set only when you are logged in administrator mode.

Setting Administrator Password

Change the administrator password by following the steps below.

▶▶▶ Important

- The password is set at the time of purchase. The password is the printer serial number. The printer serial number is printed on the sticker attached on the printer. It consists of 9 alphanumeric characters (four alphabets followed by five numbers).

1. [Display printer status on web browser.](#)

2. Select **Security**.

The menus are displayed.

3. Select **Administrator password setting**.

4. Select **Change administrator password**.

If the administrator password is not set, registration confirming message is displayed. Select **Yes**.
When message is displayed again, select **OK**.

5. Select a range where the administrator password is valid, and then select **OK**.

Remote UI or other tools

Entering the administrator password is required to change the setting items using the Remote UI or some software.

Operation panel/Remote UI/other tools

Entering the administrator password is required to change the setting items using the operation panel of the printer, the Remote UI, or some software.

6. Enter a password, and then select **OK**.

»» Important

- The following character restrictions apply to the password:
 - Set the password by using 4 to 32 characters.
 - The allowed characters are single-byte alphanumeric characters.
 - For security reasons, we recommend you use 6 and more alphanumeric characters.

7. When the completion message is displayed, select **OK**.

Setting Standard User Password

For restricting the function for standard user, enable the standard user mode and set a standard user password by following the steps below.

1. [Display printer status on web browser.](#)
2. Select **Security**.
The menus are displayed.
3. Select **Standard user mode settings**.
4. When the confirming message is displayed, select **Yes**.
5. Enter a password, and then select **OK**.

»» Important

- The following character restrictions apply to the password:
 - Set the password by using 4 to 32 characters.
 - The allowed characters are single-byte alphanumeric characters.
 - For security reasons, we recommend you use 6 and more alphanumeric characters.

6. When the completion message is displayed, select **OK**.

Setting Mail Server

To use mail function, specify the mail server settings.

▶▶▶ Note

- If you did not specify the time zone setting using the printer's operation panel, a message to inform you that the correct time may not be reflected on the sent e-mail appears. We recommended that you set the time zone setting using the printer's operation panel.

For the time zone setting, see [Dev. user settings](#).

- These functions can be set only when you are logged in administrator mode.

1. [Display printer status on web browser](#).

2. Select **Device settings**.

The menus are displayed.

3. Select **Set mail server / test connect**.

4. Select **Set mail server**.

The setting items for mail server are displayed.

5. Specify mail server settings.

Specify the following items.

Sender address

Enter the e-mail address of the sender (this printer).

Outgoing mail server (SMTP)

Enter the address of your SMTP server.

Port number (SMTP)

Enter the port number of your SMTP server.

Secure connection (SSL)

Select if you use the secure connection (SSL).

Don't verify certificates

Select if you do not verify the certificate.

Authentication method

Select one of the following authentication methods.

SMTP authentication

Select if you send e-mail with SMTP authentication.

Next, you can specify the following settings.

- **Outgoing account**

Enter the account name for sending to perform the authentication.

- **Outgoing password**

Enter the password for sending to perform the authentication.

POP before SMTP

Select if you send e-mail with POP before SMTP authentication.

Next, you can specify the following settings.

- **Incoming mail server (POP3)**

Enter the address of your POP server.

- **Port number (POP3)**

Enter the port number of your POP server.

- **Incoming account**

Enter the account name for receiving to perform the authentication.

- **Incoming password**

Enter the password for receiving to perform the authentication.

- **Use APOP authentication**

Select if you send the password by the encryption transmission.

- **Clear mailbox**

Select if you delete the e-mails that remain in the POP3 server.

»» Important

- When this setting is enabled, e-mail in the Inbox on the server will have all been removed. If you specify the e-mail address of your everyday, be sure to disable this setting as unread e-mail is not deleted. We recommended that you prepare this printer dedicated e-mail account not to accidentally delete the unread e-mail.

No authentication

Select if the authentication is not necessary.

6. After specifying mail server settings, select **OK**.

The setting operation is completed.

»» Note

- To make sure that the mail server settings have been specified correctly, select **Test connection to mail server**.

Receiving Printer Status by E-mail

You receive the printer status information such as the remaining ink level and the error from the printer.

▶▶▶ Note

- Specify the mail server settings in advance.

■ [Setting Mail Server](#)

- If you did not specify the the date and time setting using the printer's operation panel, the date and time may not be reflected on the sent e-mail. We recommended that you set the date and time setting using the printer's operation panel.

For the date and time setting, see [Dev. user settings](#).

- These functions can be set only when you are logged in administrator mode.

Specify the information settings by following the steps below.

1. [Display printer status on web browser](#).

2. Select **Device settings**.

The menus are displayed.

3. Select **Status notification e-mail**.

4. Select **Notification recipients**.

The screen to register the destination is displayed.

5. Specify destination settings.

Up to 5 destinations can be registered by following the steps below.

1. Select number of destination.
2. Select **Register**.
3. Enter e-mail address, and then select printer status to send information.
4. Select **OK**.

The registration for destination is completed.

6. Select **Device settings** -> **Status notification e-mail** -> **Retry settings**.

7. Specify resending settings.

The number of resending can be specified by following the steps below.

1. Specify number of resending.
2. Specify interval of resending.
3. Select **OK**.

The resending setting is completed.

Network Connection

- ▶ [Network Connection Tips](#)

Network Connection Tips

- ▶ **Default Network Settings**
- ▶ **Another Printer Found with Same Name**
- ▶ **Connecting to Another Computer via LAN/Changing from USB to LAN Connection**
- ▶ **Printing Network Settings**
- ▶ **Changing LAN Connection Method/Changing Wireless LAN Connection Method**

Default Network Settings

LAN Connection Defaults

Item	Default
Change LAN	LAN inactive
SSID	BJNPSETUP
Communication mode	Infrastructure
Wireless LAN security	Disable
IPv4 IP address	Auto setup
IPv6 IP address	Auto setup
Set printer name*	XXXXXXXXXXXX
Enable/disable IPv6	Active
Enable/disable WSD	Active
Timeout setting	1 minute
Enab./disab. Bonjour	Active
Service name	Canon iB4100 series
LPR setting	Active
DRX setting (Wired LAN)	Active
RAW protocol	Active
LLMNR	Active

("XX" represents alphanumeric characters.)

* Default value depends on printer. To check value, use operation panel.

■ [LAN settings](#)

Direct Connection Defaults

Item	Default
SSID (Identifier for direct connection)	DIRECT-abXX-iB4100series *1
Password	YYYYYYYYYYY *2
Security protocol	WPA2-PSK (AES)
Direct connection device name	ZZZZZZ-iB4100series *3
Confirm request	Displayed

*1 "ab" is specified at random and "XX" represents last two digits of printer's MAC address. (The value is specified when the printer is turned on for the first time.)

*2 The password is specified automatically when the printer is turned on for the first time.

*3 "ZZZZZZ" represents last six digits of printer's MAC address.

Another Printer Found with Same Name

When the printer is found during setup, other printers with the same name may appear on the results screen.

Select a printer with checking the printer settings against those on detection result screen.

- For Windows:

Check the printer's MAC address or serial to select the correct printer from the results.

- For Mac OS:

The printer names appear with the MAC address added at the end or as the printer name specified by Bonjour.

Check identifiers such as the MAC address, the printer name specified by Bonjour, and the printer's serial number to select the printer from among those that appear.

»» Note

- Serial number may not appear on result screen.

Check the printer's MAC address and the serial number by one of the following methods.

- Display on the LCD.

MAC address

- [LAN settings](#)

Serial number

- [System information](#)

- Print the network settings.

- [Printing Network Settings](#)

Connecting to Another Computer via LAN/Changing from USB to LAN Connection

■ [For Windows:](#)

■ [For Mac OS:](#)

For Windows:

To add a computer to connect to the printer on a LAN or to change from USB to LAN connection, perform setup using the Setup CD-ROM or follow the instructions on the Canon website.

For Mac OS:

To connect an additional computer to the printer via LAN, or to change from USB to LAN connection, follow the instructions on the Canon website.

Printing Network Settings

Use the operation panel to print the printer's current network settings.

▶▶▶ Important

- The network settings printout contains important information about your network. Handle it with care.

1. [Make sure printer is turned on.](#)
2. [Load three sheets of A4 or Letter-sized plain paper.](#)
3. Press **Setup** button.
Setup menu screen appears.
4. Select **Device settings** and press **OK** button.
5. Select **LAN settings** and press **OK** button.
6. Select **Print LAN details** and press **OK** button.

The printer starts printing network settings information.

The printed network settings information is as follows:

Item	Description	Setting
Product Information	Product information	—
Product Name	Product name	XXXXXXXXXX
ROM Version	ROM version	XXXXXXXXXX
Serial Number	Serial number	XXXXXXXXXX
Wireless LAN	Wireless LAN	Enable/Disable
MAC Address	MAC address	XX:XX:XX:XX:XX:XX
Infrastructure	Infrastructure	Enable/Disable
Connection	Connection status	Active/Inactive
SSID	SSID	Wireless LAN SSID
Channel *1	Channel	XX (1 to 11)
Encryption	Encryption method	None/WEP/TKIP/AES
WEP Key Length	WEP key length (bits)	Inactive/128/64
Authentication	Authentication method	None/auto/open/shared/WPA-PSK/WPA2-PSK

Signal Strength	Signal strength	0 to 100 [%]
TCP/IPv4	TCP/IPv4	Enable
IP Address	IP address	XXX.XXX.XXX.XXX
Subnet Mask	Subnet mask	XXX.XXX.XXX.XXX
Default Gateway	Default gateway	XXX.XXX.XXX.XXX
TCP/IPv6	TCP/IPv6	Enable/Disable
Link Local Address	Link local address	XXXX:XXXX:XXXX:XXXX XXXX:XXXX:XXXX:XXXX
Link Local Prefix Length	Link local prefix length	XXX
Manual Setting	Manual setting	Enable/Disable
IP Address *2	IP address	XXXX:XXXX:XXXX:XXXX XXXX:XXXX:XXXX:XXXX
Subnet Prefix Length	Subnet prefix length	XXX
Stateless Address1 *2	Stateless address 1	XXXX:XXXX:XXXX:XXXX XXXX:XXXX:XXXX:XXXX
Stateless Prefix Length 1 *2	Stateless prefix length 1	XXX
Stateless Address2 *2	Stateless address 2	XXXX:XXXX:XXXX:XXXX XXXX:XXXX:XXXX:XXXX
Stateless Prefix Length2 *2	Stateless prefix length 2	XXX
Stateless Address3 *2	Stateless address 3	XXXX:XXXX:XXXX:XXXX XXXX:XXXX:XXXX:XXXX
Stateless Prefix Length3 *2	Stateless prefix length 3	XXX
Stateless Address4 *2	Stateless address 4	XXXX:XXXX:XXXX:XXXX XXXX:XXXX:XXXX:XXXX
Stateless Prefix Length4 *2	Stateless prefix length 4	XXX
Default Gateway1 *2	Default gateway 1	XXXX:XXXX:XXXX:XXXX XXXX:XXXX:XXXX:XXXX
Default Gateway2 *2	Default gateway 2	XXXX:XXXX:XXXX:XXXX XXXX:XXXX:XXXX:XXXX
Default Gateway3 *2	Default gateway 3	XXXX:XXXX:XXXX:XXXX XXXX:XXXX:XXXX:XXXX
Default Gateway4 *2	Default gateway 4	XXXX:XXXX:XXXX:XXXX XXXX:XXXX:XXXX:XXXX

IPsec *3	IPsec setting	Active
Security Protocol *3	Security method	ESP/ESP & AH/AH
Direct Connection	Direct connection	Enable/Disable
Connection	Connection status	Active/Inactive
SSID	SSID	Direct Connection SSID
Password	Password	Direct Connection password (10 alphanumeric characters)
Channel	Channel	3
Encryption	Encryption method	AES
Authentication	Authentication method	WPA2-PSK
TCP/IPv4	TCP/IPv4	Enable
IP Address	IP address	XXX.XXX.XXX.XXX
Subnet Mask	Subnet mask	XXX.XXX.XXX.XXX
Default Gateway	Default gateway	XXX.XXX.XXX.XXX
TCP/IPv6	TCP/IPv6	Enable/Disable
Link Local Address	Link local address	XXXX:XXXX:XXXX:XXXX XXXX:XXXX:XXXX:XXXX
Subnet Prefix Length *2	Subnet prefix length	XXX
IPsec *3	IPsec setting	Active
Security Protocol *3	Security method	–
Wired LAN	Wired LAN	Enable/Disable
MAC Address	MAC address	XX:XX:XX:XX:XX:XX
Connection	Wired LAN status	Active/Inactive
TCP/IPv4	TCP/IPv4	Enable
IP Address	IP address	XXX.XXX.XXX.XXX
Subnet Mask	Subnet mask	XXX.XXX.XXX.XXX
Default Gateway	Default gateway	XXX.XXX.XXX.XXX
TCP/IPv6	TCP/IPv6	Enable/Disable
Link Local Address	Link local address	XXXX:XXXX:XXXX:XXXX XXXX:XXXX:XXXX:XXXX

Link Local Prefix Length	Link local prefix length	XXX
Manual Setting	Manual setting	Enable/Disable
IP Address *2	IP address	XXXX:XXXX:XXXX:XXXX XXXX:XXXX:XXXX:XXXX
Subnet Prefix Length	Subnet prefix length	XXX
Stateless Address1 *2	Stateless address 1	XXXX:XXXX:XXXX:XXXX XXXX:XXXX:XXXX:XXXX
Stateless Prefix Length1 *2	Stateless prefix length 1	XXX
Stateless Address2 *2	Stateless address 2	XXXX:XXXX:XXXX:XXXX XXXX:XXXX:XXXX:XXXX
Stateless Prefix Length2 *2	Stateless prefix length 2	XXX
Stateless Address3 *2	Stateless address 3	XXXX:XXXX:XXXX:XXXX XXXX:XXXX:XXXX:XXXX
Stateless Prefix Length3 *2	Stateless prefix length 3	XXX
Stateless Address4 *2	Stateless address 4	XXXX:XXXX:XXXX:XXXX XXXX:XXXX:XXXX:XXXX
Stateless Prefix Length4 *2	Stateless prefix length 4	XXX
Default Gateway1 *2	Default gateway 1	XXXX:XXXX:XXXX:XXXX XXXX:XXXX:XXXX:XXXX
Default Gateway2 *2	Default gateway 2	XXXX:XXXX:XXXX:XXXX XXXX:XXXX:XXXX:XXXX
Default Gateway3 *2	Default gateway 3	XXXX:XXXX:XXXX:XXXX XXXX:XXXX:XXXX:XXXX
Default Gateway4 *2	Default gateway 4	XXXX:XXXX:XXXX:XXXX XXXX:XXXX:XXXX:XXXX
IPsec *3	IPsec setting	Active
Security Protocol *3	Security method	ESP/ESP & AH/AH
Wired LAN DRX	Discontinuous reception (wired LAN)	Enable/Disable
Other Settings	Other settings	–
Printer Name	Printer name	Printer name (Up to 15 alphanumeric characters)
Direct Conn. DevName	Device name for direct connection (Up to 32 characters)	Device name for direct connection

WSD Printing	WSD printing setting	Enable/Disable
WSD Timeout	Timeout	1/5/10/15/20 [min]
LPD Printing	LPD printing setting	Enable/Disable
RAW Printing	RAW printing setting	Enable/Disable
Bonjour	Bonjour setting	Enable/Disable
Bonjour Service Name	Bonjour service name	Bonjour service name (Up to 52 alphanumeric characters)
LLMNR	LLMNR setting	Enable/Disable
SNMP	SNMP setting	Enable/Disable
DNS Server	Obtain DNS server address automatically	Auto/Manual
Primary Server	Primary server address	XXX.XXX.XXX.XXX
Secondary Server	Secondary server address	XXX.XXX.XXX.XXX
Proxy Server	Proxy server setting	Enable/Disable
Proxy Address	Proxy address	XXXXXXXXXXXXXXXXXXXXXXXX
Proxy Port	Proxy port specification	1 to 65535
Cert. Fingerprt(SHA-1)	Certificate fingerprint(SHA-1)	XXXXXXXXXX XXXXXXXXXXX XXXXXXXXXXX XXXXXXXXXX XXXXXXXXXXX
Cert. Fingerprt(SHA-256)	Certificate fingerprint(SHA-256)	XXXXXXXXXX XXXXXXXXXXX XXXXXXXXXXX XXXXXXXXXX XXXXXXXXXX XXXXXXXXXXX XXXXXXXXXXX XXXXXXXXXX

("XX" represents alphanumeric characters.)

*1 Channel may range from 1 to 11 depending on country or region of purchase.

*2 Network status is only printed when IPv6 is enabled.

*3 Network status is only printed when IPv6 and IPsec settings are enabled.

Changing LAN Connection Method/Changing Wireless LAN Connection Method

■ [Changing LAN Connection Method](#)

■ [Changing Wireless LAN Connection Method](#)

Changing LAN Connection Method

Follow either procedure below to change LAN connection method (wired or wireless).

• For Windows:

- Use the Setup CD-ROM or follow the instructions on the Canon website to redo setup.
- Press the **Setup** button, select **Device settings** > **LAN settings** > **Change LAN** and select **Wireless LAN** or **Wired LAN**.

After that, perform settings on the **Protocol Settings...** screen on IJ Network Device Setup Utility.

For details, refer to [Performing/Changing Wireless LAN Settings](#) or [Performing/Changing Wired LAN Settings](#) to change the connection method from wired LAN to wireless LAN.

• For Mac OS:

- Follow the instructions on the Canon website to redo setup.
- Press the **Setup** button, select **Device settings** > **LAN settings** > **Change LAN** and select **Wireless LAN** or **Wired LAN**.

After that, perform settings on the **Wireless LAN** or **Wired LAN** sheet on IJ Network Tool.

For details, refer to Changing Settings in Wireless LAN Sheet or Changing Settings in Wired LAN Sheet to change the connection method from wired LAN to wireless LAN.

Changing Wireless LAN Connection Method

Follow either procedure below to change wireless LAN connection method (infrastructure or direct connection).

• For Windows:

- Use the Setup CD-ROM or follow the instructions on the Canon website to redo setup.
- Perform settings on the **Protocol Settings** screen on IJ Network Device Setup Utility.

▶▶▶ Important

- Before you perform settings using IJ Network Device Setup Utility, turn on cableless setup mode on the printer following the procedure below.

1. [Make sure printer is turned on.](#)
2. Press **Setup** button.
Setup menu screen appears.
3. Select **Wireless LAN setup** and press **OK** button.
4. Select **Cableless setup** and press **OK** button.
5. Check message and press **OK** button.

Follow instructions on your smartphone or tablet.

6. If message saying setup is completed appears, press **OK** button.

- **For Mac OS:**

Follow the instructions on the Canon website to redo setup.

Network Settings (IJ Network Device Setup Utility) (Windows)

- ▶ **IJ Network Device Setup Utility**
- ▶ **Starting Up IJ Network Device Setup Utility**
- ▶ **IJ Network Device Setup Utility Screen**
- ▶ **Performing Network Settings**
- ▶ **Checking Network Status**
- ▶ **IJ Network Device Setup Utility Menus**
- ▶ **Other Network Information**

IJ Network Device Setup Utility

IJ Network Device Setup Utility allows a network/printer administrator to manage printers on network. When you perform printer setup, the utility is installed at the same time.

Use IJ Network Device Setup Utility for:

- Searching printers on network and performing initial network setup for detected printers
- Performing initial network setup by connecting the printer and computer using a USB cable (Not available for some models)
- Changing printer network settings
- Checking status between computer on which IJ Network Device Setup Utility is installed and printer if anything is wrong with connection

»» Important

- Depending on the printer you are using, an administrator password is already specified for the printer at the time of purchase. When you change the network settings, authentication by the administrator password is required.

For details:

- [Administrator Password](#)

For improving security, we recommend to change the administrator password.

- [Changing Administrator Password](#)

- To use the printer over LAN, make sure you have the equipment necessary for the connection type, such as a wireless router or a LAN cable.
- When you perform setup or install IJ Network Device Setup Utility, disable block function of firewall.
- Do not change network settings using IJ Network Device Setup Utility while printing is in progress.

Starting Up IJ Network Device Setup Utility

Start up IJ Network Device Setup Utility as shown below.

- In Windows 10, click the **Start** button, select **All apps**, **Canon Utilities**, and then **IJ Network Device Setup Utility**. If **IJ Network Device Setup Utility** is not displayed, search for "IJ Network Device Setup Utility" on **Search the web and Windows**.
- In Windows 8.1 or Windows 8, select **IJ Network Device Setup Utility** on the **Start** screen to start IJ Network Device Setup Utility. If **IJ Network Device Setup Utility** is not displayed on the **Start** screen, select the **Search** charm and search for "IJ Network Device Setup Utility".
- In Windows 7 or Windows Vista, click **Start** and select **All Programs**, **Canon Utilities**, **IJ Network Device Setup Utility**, and then **IJ Network Device Setup Utility**.

When you start up IJ Network Device Setup Utility, it searches for printers on network and detected printers are listed.

IJ Network Device Setup Utility Screen

- [Items on IJ Network Device Setup Utility Screen](#)
- [Menus on IJ Network Device Setup Utility Screen](#)
- [Items on IJ Network Device Setup Utility Screen Toolbar](#)

Items on IJ Network Device Setup Utility Screen

The screen below appears when you start up IJ Network Device Setup Utility. Detected printers are listed on the screen and the items below are shown.

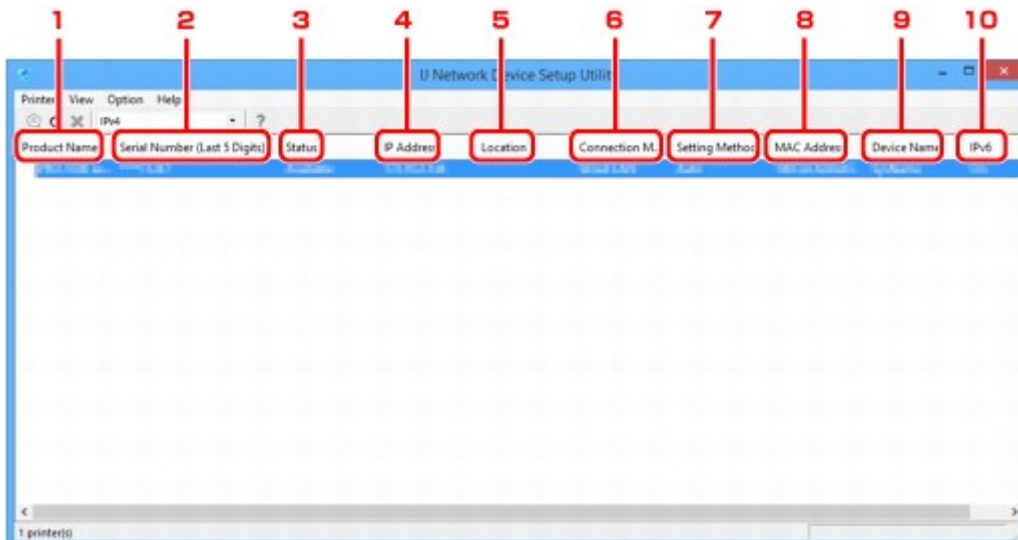

1. Product Name

Displays the product name of detected printer. The icon below appears on the left if the printer cannot be used.

: Appears when the printer has not been connected or configured.

: Appears when the IP address is duplicated to another printer.

: Appears when you cannot communicate with the printer.

Note

- If a printer you want to use is not detected, try to set the criteria for printer search.

- [Setting Criteria for Printer Search/Searching Specific Printer](#)

2. Serial Number (Last 5 Digits)

Displays the last five digits of printer's serial number.

3. Status

Displays the printer status as shown below.

Available

Indicates the printer is available.

Setup Completed

Appears after performing network setup and clicking **Set** to close the window.

Not Connected

Indicates the printer is required to perform wireless LAN setup.

■ [Performing/Changing Wireless LAN Settings](#)

Not Set

Indicates the printer cannot be used on network. Specify an IP address or enable IPv6.

IP Address Overlap

Indicates the IP address is duplicated to another printer.

Unknown

Indicates the printer used in the past cannot be used currently.

▶▶▶ Note

- If **USB** is selected from the pulldown menu on the toolbar, nothing is displayed.

4. IP Address

Displays the printer IP address.

▶▶▶ Note

- If **USB** is selected from the pulldown menu on the toolbar, "-" is displayed for the interface (wireless/wired LAN) disabled on the printer setting.

5. Location

Displays the printer location if it is registered.

▶▶▶ Note

- If **USB** is selected from the pulldown menu on the toolbar, nothing is displayed.

■ [Assigning Printer Information](#)

6. Connection Method

Displays printer connection method (wired or wireless LAN).

▶▶▶ Note

- If **USB** is selected from the pulldown menu on the toolbar, either of the LAN connection method (wired or wireless) available for the printer is displayed.
- If the printer supports both of the LAN connection methods, the printer is recognized as two printers and they are displayed separately.
- If the printer does not support wired LAN, wired LAN is not displayed.
- If you are using IJ Network Device Setup Utility on the computer which does not support wireless LAN, wireless LAN is not displayed.
- If you are using the printer with direct connection, neither wired LAN nor wireless LAN is displayed.

7. Setting Method

Displays printer setting method.

- **Auto**

Appears if the printer is used by IP address specified automatically.

- **Manual**

Appears if the printer is used by IP address specified manually.

▶▶▶ Note

- If **USB** is selected from the pulldown menu on the toolbar, "-" is displayed for the interface (wireless/wired LAN) disabled on the printer setting.

8. MAC Address

Displays the MAC address of the detected printer.

▶▶▶ Note

- If **USB** is selected from the pulldown menu on the toolbar, "-" is displayed for the interface (wireless/wired LAN) disabled on the printer setting.

9. Device Name

Displays the printer device name if it is registered.

▶▶▶ Note

- If **USB** is selected from the pulldown menu on the toolbar, nothing is displayed.

■ [Assigning Printer Information](#)

10. IPv6

On appears when an IPv6 address is assigned for the printer.

▶▶▶ Note

- If **USB** is selected from the pulldown menu on the toolbar, "-" is displayed.

Menus on IJ Network Device Setup Utility Screen

This section describes menus on IJ Network Device Setup Utility screen.

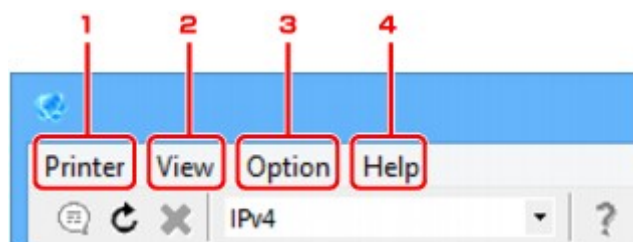

1. **Printer** menu

■ [Printer Menu](#)

2. **View** menu

■ [View Menu](#)

3. **Option** menu

■ [Option Menu](#)

4. **Help** menu

■ [Help Menu](#)

Items on IJ Network Device Setup Utility Screen Toolbar

This section describes items on IJ Network Device Setup Utility Screen toolbar.

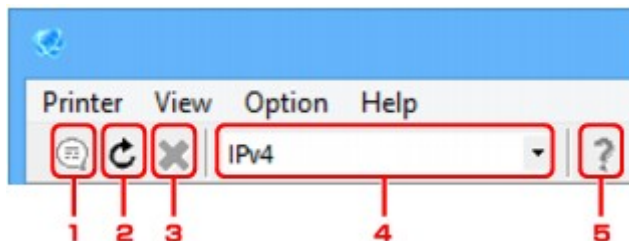

1. Perform wired or wireless LAN setup.

▶▶▶ **Note**

- This item has the same function as [Protocol Settings...](#) in the **Printer** menu.

2. Redetects printers.

▶▶▶ **Note**

- This item has the same function as [Update](#) in the **View** menu.

3. Stops detecting printers.

▶▶▶ **Note**

- This item has the same function as [Cancel](#) in the **View** menu.

4. Switches the printer list. (IPv4, IPv6, or USB printers)

▶▶▶ **Note**

- This item has the same function as [Switch IPv4/IPv6/USB](#) in the **View** menu.
- You can also display the USB connected printer list. (Not available for some models.) In this case, select **USB**.

5. Displays this guide.

»» Note

- This item has the same function as [Online Manual](#) in the **Help** menu.

Performing Network Settings

- ▶ **Performing/Changing Wired LAN Settings**
- ▶ **Performing/Changing Wireless LAN Settings**
- ▶ **Assigning Printer Information**
- ▶ **Initializing Network Settings**
- ▶ **Changing Administrator Password**
- ▶ **Setting Criteria for Printer Search/Searching Specific Printer**
- ▶ **If WEP Details Screen Appears**
- ▶ **If WPA/WPA2 Details Screen Appears**

Performing/Changing Wired LAN Settings

Follow the procedure below to perform/change wired LAN settings.

▶▶▶ Note

- For some models, you can perform network setup for a USB connected printer using IJ Network Device Setup Utility. Select **USB** on **Switch IPv4/IPv6/USB** under the **View** menu to display printers for which you can perform setup.

1. [Start up IJ Network Device Setup Utility.](#)

Detected printers are listed.

2. Select printer to perform/change settings from printer list.

Select the printer with **Wired LAN** displayed on **Connection Method** and the setting other than **Unknown** or **Setup Completed** displayed on **Status** to perform settings.

To perform setup for a USB connected printer, select **USB** from the pulldown menu on the toolbar and select the printer with **Wired LAN** displayed on **Connection Method**.

3. Select **Protocol Settings...** on **Printer** menu.

The **Confirm Printer Password** screen appears.

For more on the password, refer to [Administrator Password](#).

▶▶▶ Note

- Clicking the  icon allows you to perform/change settings.

4. Enter password and click **OK**.

The **Protocol Settings** screen appears.

5. Perform/change settings.

You can switch the screen between IPv4 and IPv6. Click the tab to switch the protocol.

- IPv4 settings

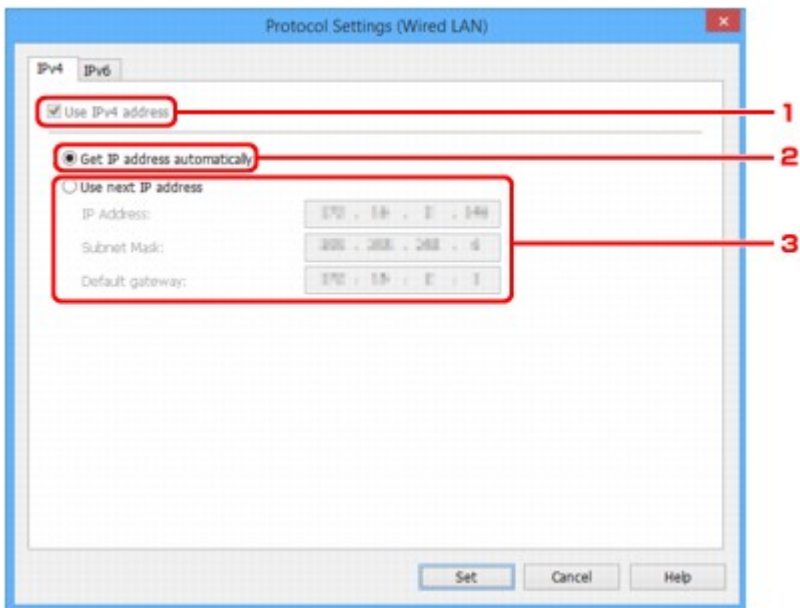

1. Use IPv4 address

Always selected. (displayed in a gray out state)

2. Get IP address automatically

Select this option to use an IP address automatically assigned by a DHCP server. DHCP server functionality must be enabled on your router.

3. Use next IP address

Select this option if no DHCP server functionality is available in your setup where you use the printer, or you want to use a fixed IP address.

Enter the IP address, subnet mask, and default gateway.

• IPv6 settings

▶▶▶ Note

- If **USB** is selected from the pulldown menu on the toolbar, you cannot perform IPv6 settings.

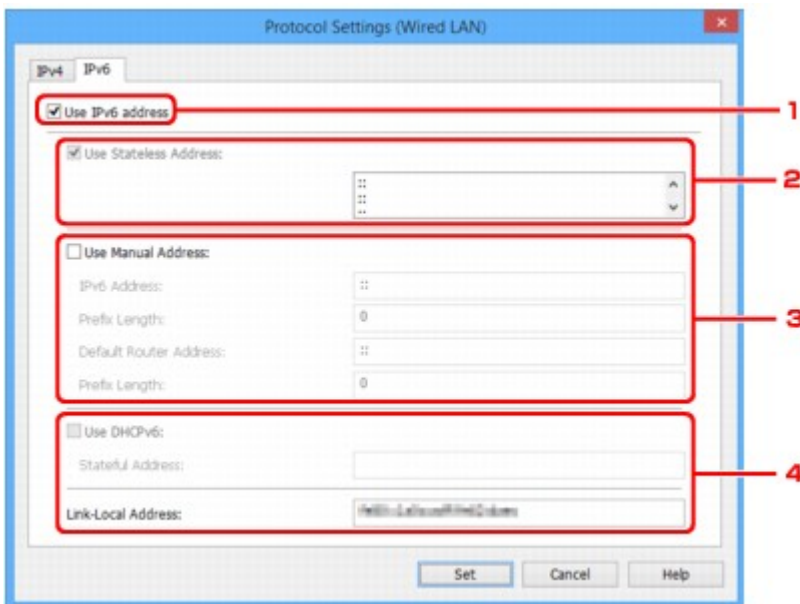

1. **Use IPv6 address**

Select when you use the printer with IPv6 environment.

2. **Use Stateless Address:**

Select when you use an IP address assigned automatically. Use a router compatible with IPv6.

▶▶▶ Note

- This setting item is not available depending on the printer you are using.

3. **Use Manual Address:**

Select this option if no DHCP server functionality is available in your setup where you use the printer, or you want to use a fixed IP address.

Enter the IP address and IP address prefix length.

▶▶▶ Note

- This setting item is not available depending on the printer you are using.

4. **Use DHCPv6:**

Select when you obtain an IP address using DHCPv6.

▶▶▶ Note

- This setting item is not available depending on the printer you are using.

6. Click **Set**.

Performing/Changing Wireless LAN Settings

Follow the procedure below to perform/change wireless LAN settings.

▶▶▶ Important

- Enable cableless setup before performing printer setup. (Not required if you change the IP address.)
For details, search for "NR049" on your printer's online manual and see the page shown.

▶▶▶ Note

- For some models, you can perform network setup for a USB connected printer using IJ Network Device Setup Utility. Select **USB** on **Switch IPv4/IPv6/USB** under the **View** menu to display printers.

1. [Start up IJ Network Device Setup Utility.](#)

Detected printers are listed.

2. Select printer to perform/change settings from printer list.

Select the printer with **Wireless LAN** displayed on **Connection Method** and the setting other than **Unknown** or **Setup Completed** displayed on **Status** to perform settings.

To perform setup for a USB connected printer, select **USB** from the pulldown menu on the toolbar and select the printer with **Wireless LAN** displayed on **Connection Method**.

3. Select **Protocol Settings...** on **Printer** menu.

The **Confirm Printer Password** screen appears.

For more on the password, refer to [Administrator Password](#).

▶▶▶ Note

- Clicking the  icon allows you to perform/change settings.

4. Enter password and click **OK**.

The **Protocol Settings** screen appears.

5. Perform/change settings.

You can switch the screen between IPv4 and IPv6. Click the tab to switch the protocol.

- IPv4/IPv6 settings

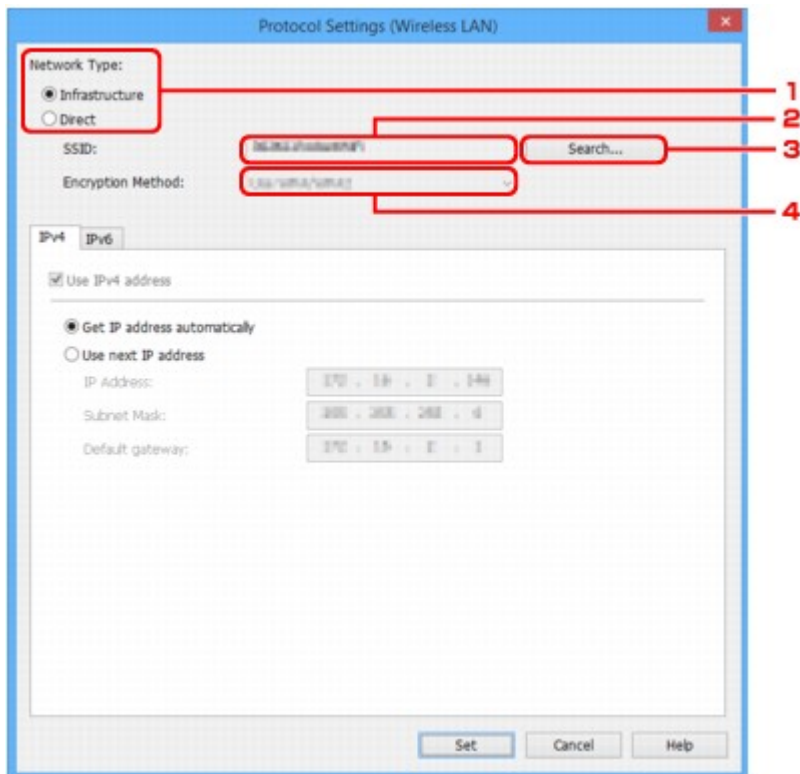

1. Network Type:

Select the wireless LAN mode.

Infrastructure

Connects the printer to the wireless LAN with a wireless router.

Direct

Connects the printer to wireless communication devices without a wireless router.

▶▶▶ Note

- If **Direct** is selected, the **Search...** button is displayed in a gray out status.
In addition, you cannot connect to Internet from your computer depending on your operating environment.

2. SSID:

The network identifier (SSID) of the wireless LAN currently used is displayed.

The identifier for direct connection (SSID) appears while in direct connection.

3. Search...

The **Detected Wireless Routers** screen is displayed to select a wireless router to connect to. For a wireless router already connected to the computer, **Available** is displayed on **Communication Status**.

If you select a wireless router with **Not Connected** on **Communication Status** from the list, clicking **Set** displays the WPA/WPA2 or WEP setting screen for a wireless router.

■ [If WEP Details Screen Appears](#)

■ [If WPA/WPA2 Details Screen Appears](#)

4. Encryption Method:

Displays the encryption method used over the wireless LAN.

- IPv4 settings

▶▶▶ Note

- The setting items below are available only when **Infrastructure** is selected for **Network Type**:

If **Direct** is selected, the setting items below are displayed in a gray out status.

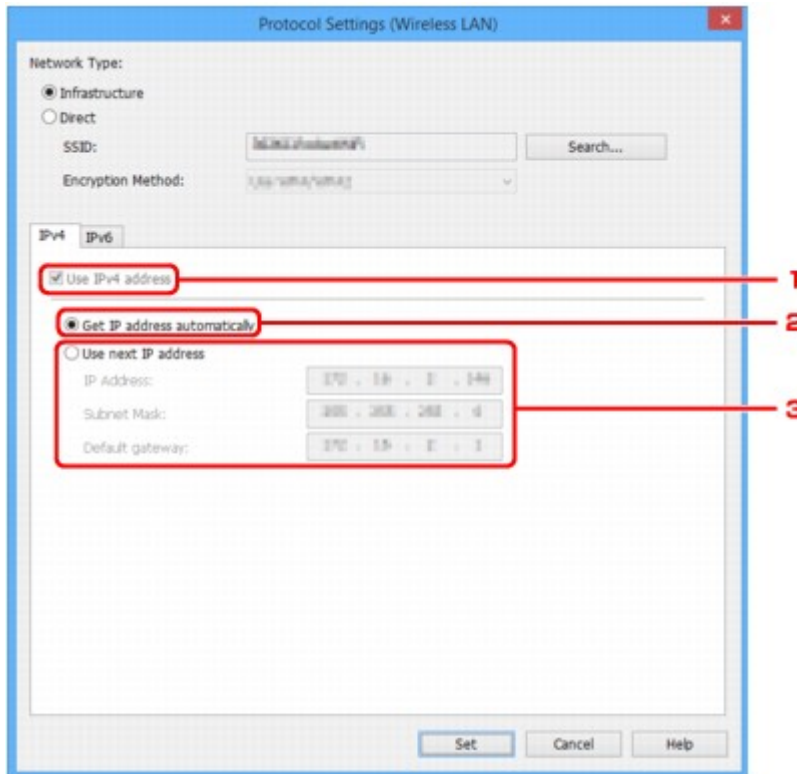

1. Use IPv4 address

Always selected. (displayed in a gray out state)

2. Get IP address automatically

Select this option to use an IP address automatically assigned by a DHCP server. DHCP server functionality must be enabled on your router.

3. Use next IP address

Select this option if no DHCP server functionality is available in your setup where you use the printer, or you want to use a fixed IP address.

Enter the IP address, subnet mask, and default gateway.

- IPv6 settings

▶▶▶ Note

- If **USB** is selected from the pulldown menu on the toolbar, you cannot perform IPv6 settings.
- The setting items below are available only when **Infrastructure** is selected for **Network Type**:

If **Direct** is selected, the setting items below are displayed in a gray out status.

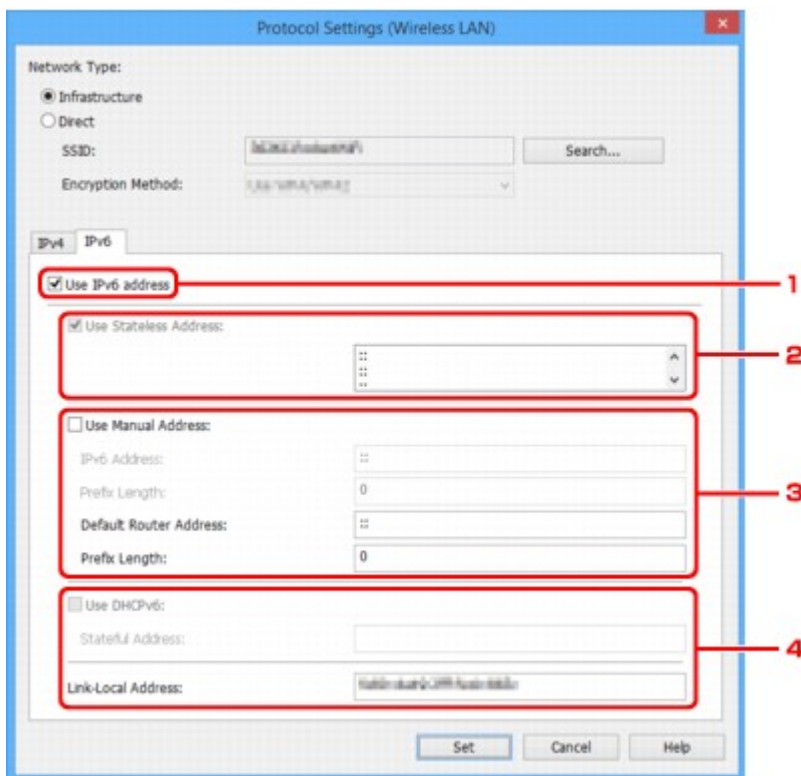

1. Use IPv6 address

Select when you use the printer with IPv6 environment.

2. Use Stateless Address:

Select when you use an IP address assigned automatically. Use a router compatible with IPv6.

»» Note

- This setting item is not available depending on the printer you are using.

3. Use Manual Address:

Select this option if no DHCP server functionality is available in your setup where you use the printer, or you want to use a fixed IP address.

Enter the IP address and IP address prefix length.

»» Note

- This setting item is not available depending on the printer you are using.

4. Use DHCPv6:

Select when you obtain an IP address using DHCPv6.

»» Note

- This setting item is not available depending on the printer you are using.

6. Click **Set**.

Assigning Printer Information

Follow the procedure below to assign/change printer location name or device name.

The names appear on **Device Name:** and **Location:** on the **IJ Network Device Setup Utility** screen.

»» Note

- If **USB** is selected from the pulldown menu on the toolbar, this setting item is not available.

1. [Start up IJ Network Device Setup Utility.](#)

Detected printers are listed.

2. Select printer to assign location name and device name.

Select the printer with **Available** displayed on **Status**.

3. Select **Detailed Printer Settings...** on **Printer** menu.

The **Confirm Printer Password** screen appears.

For more on the password, refer to [Administrator Password](#).

4. Enter password and click **OK**.

The **Detailed Printer Settings** screen appears.

5. Perform/change settings.

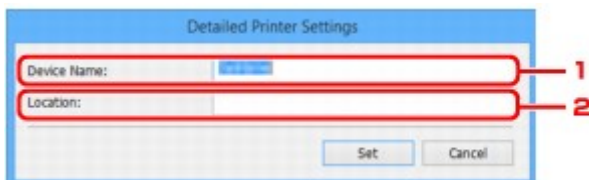

The setting items below are available.

1. **Device Name:**

Assigns the device name.

2. **Location:**

Assigns the location name.

6. Click **Set**.

Initializing Network Settings

Follow the procedure below to initializing printer network settings.

1. [Start up IJ Network Device Setup Utility.](#)

Detected printers are listed.

2. Select printer to initialize settings.

Select the printer with **Available** displayed on **Status**.

3. Select **Reset LAN settings** on **Printer** menu.

The **Confirm Printer Password** screen appears.

For more on the password, refer to [Administrator Password](#).

4. Enter password and click **OK**.

5. Click **Yes** on the displayed screen.

6. Click **OK** on the displayed screen.

The printer network settings are initialized.

Changing Administrator Password

Follow the procedure below to change the administrator password.

1. [Start up IJ Network Device Setup Utility.](#)

Detected printers are listed.

2. Select printer to change password.

Select the printer with **Available** displayed on **Status**.

3. Select **Change Password...** on **Printer** menu.

The **Change Printer Password** screen appears.

For more on the password, refer to [Administrator Password](#).



The image shows a screenshot of a Windows-style dialog box titled "Change Printer Password". The dialog has a light blue border and a title bar with a close button (X) in the top right corner. Inside the dialog, there are three text input fields stacked vertically, labeled "Old Password:", "New Password:", and "Confirm:". At the bottom right of the dialog, there are two buttons: "OK" and "Cancel".

4. Enter current password and new password.

5. Enter new password in **Confirm:** again.

6. Click **OK**.

The administrator password is updated.

Setting Criteria for Printer Search/Searching Specific Printer

You can set the criteria for printer search when you start up IJ Network Device Setup Utility or update the printer search, or you can search the specific printer.

Changing these settings may detect the printer you want to use if it is not detected

▶▶▶ Note

- If the printer you want to use is not detected, it may be detected by entering IP address, subnet mask, or default gateway on the operation panel and search again.

■ [Setting Criteria for Printer Search](#)

■ [Searching Specific Printer](#)

Setting Criteria for Printer Search

1. [Start up IJ Network Device Setup Utility.](#)
2. Select **Search Settings...** on **Option** menu.
The **Search Settings** screen appears.
3. Enter criteria for printer search.

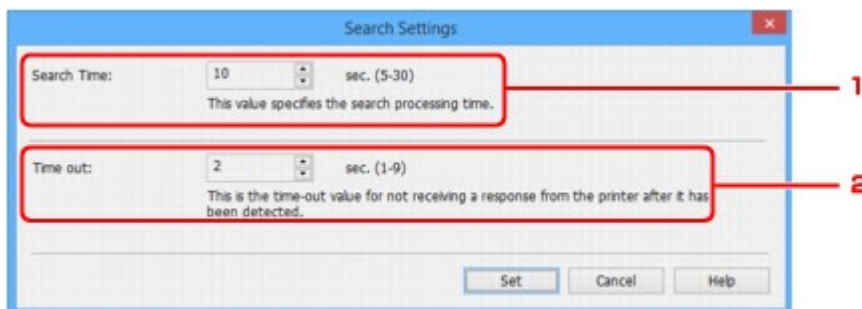

1. **Search Time:**
Specifies the time to search printers.
2. **Time out:**
Specifies the timeout length for not receiving a response from printer.

▶▶▶ Note

- Printers you want to find are more likely to be detected as the values are larger, however, it may take a while to search them.

4. Click **Set**.

Searching Specific Printer

1. [Start up IJ Network Device Setup Utility.](#)

2. Select **Specified Searching...** on **Option** menu.

The **Specified Searching** screen appears.

3. Select item to specify and enter value.

Specified Searching

Select the search method, and then click [Search].
The results will be displayed in the list.

IPv4 Address

IPv6 Address

Host Name

Search Cancel Help

1. **IPv4 Address**

Specifies the IPv4 address of the printer you want to search.

2. **IPv6 Address**

Specifies the IPv6 address of the printer you want to search.

3. **Host Name**

Specifies the host name of the printer you want to search.

4. Click **Search**.

IJ Network Device Setup Utility starts searching by the specified criteria and detected printers are listed.

If WEP Details Screen Appears

Enter the password (passphrase) according to wireless router's encryption method if you change a wireless router to connect to the printer.

1. Enter items below when **WEP Details** screen appears.

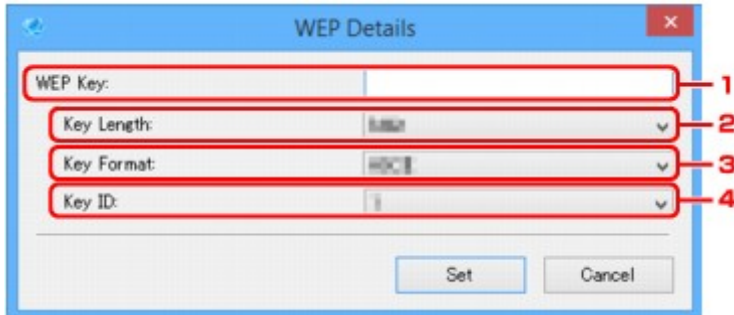

1. **WEP Key:**

Enter the same key as the one set to the wireless router.

The number of characters and character type that can be entered differ depending on the combination of the key length and key format.

		Key Length:	
		64bit	128bit
Key Format:	ASCII	5 characters	13 characters
	Hexadecimal (Hex)	10 digits	26 digits

2. **Key Length:**

Select either **64bit** or **128bit**.

3. **Key Format:**

Select either **ASCII** or **Hex**.

4. **Key ID:**

Select the Key ID (index) set to the wireless router.

2. Click **Set**.

▶▶▶ Important

- If the printer cannot communicate with the computer after the encryption type of the printer was switched, make sure encryption types for the computer and the wireless router match that set to the printer.

If WPA/WPA2 Details Screen Appears

Enter the password (passphrase) according to wireless router's encryption method if you change a wireless router to connect to the printer.

1. Enter passphrase when **WPA/WPA2 Details** screen appears.

Enter the passphrase set to the wireless router. The passphrase should be a string of 8 to 63 alphanumeric characters or a 64-digit hexadecimal value.

If you do not know the wireless router passphrase, refer to the instruction manual provided with the wireless router or contact its manufacturer.

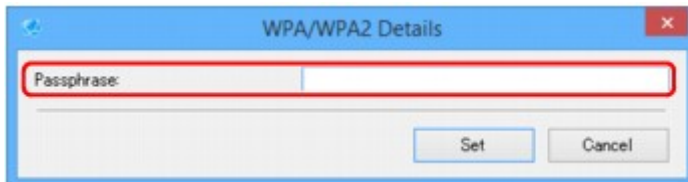

2. Click **Set**.

▶▶▶ Important

- If the printer cannot communicate with the computer after the encryption type of the printer was switched, make sure encryption types for the computer and the wireless router match that set to the printer.

Checking Network Status

- **Checking Wireless Network Status**
- **Displaying Computer Network Information**
- **Displaying Printer Network Information**
- **Checking Connection Status between Printer and Wireless Router**
- **Checking Network Setting Difference**

Checking Wireless Network Status

Follow the procedure below to check the wireless network status (signal strength) between the printer and computer.

If anything is wrong with the wireless LAN connection, check the network status from this menu.

1. [Start up IJ Network Device Setup Utility.](#)

The detected printers are listed.

2. Select printer to check wireless network status from printer list.

Select the printer with **Available** displayed on **Status**.

3. Select **Check Wireless Communication Status** on **Printer** menu.

The **Confirm Printer Password** screen appears.

For more on the password, refer to [Administrator Password](#).

4. Enter password and click **OK**.

- If the printer is connected to the computer with a wireless router:

The screen below appears.

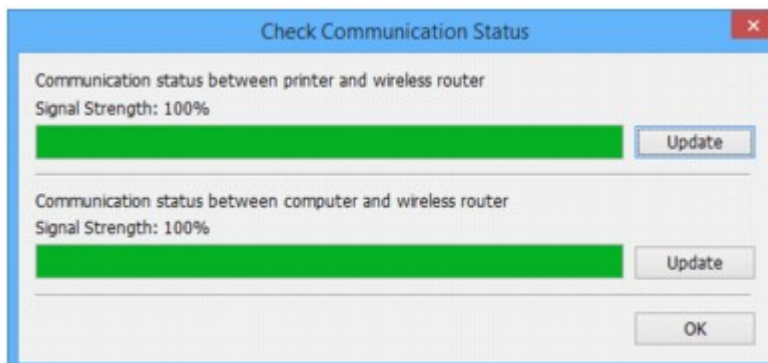

- If the printer is connected to the computer using direct connection:

The screen below appears.

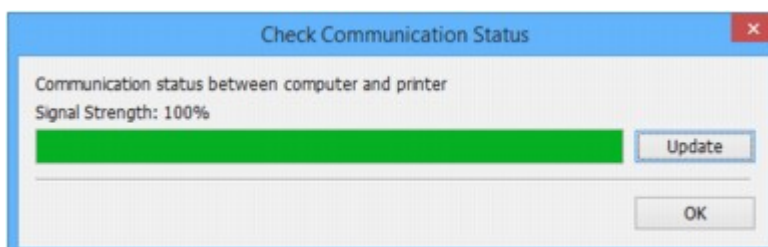

Clicking **Update** measures the signal strength again.

5. Click **OK** to close screen.

Displaying Computer Network Information

Follow the procedure below to display the network information of the computer which the printer selected in the **IJ Network Device Setup Utility** screen connects to and on which IJ Network Device Setup Utility is installed.

1. [Start up IJ Network Device Setup Utility.](#)
2. Select **Computer Network Information** on **View** menu.

The screen below appears.

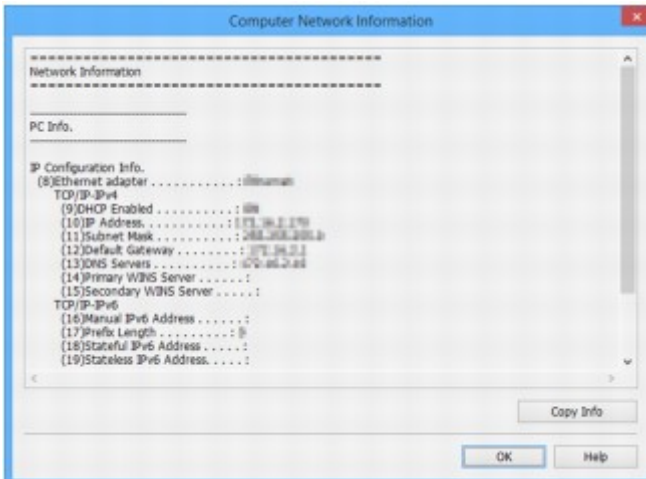

Clicking **Copy Info** copies all network information on the clipboard.

3. Click **OK** to close screen.

Displaying Printer Network Information

Follow the procedure below to display the printer network information.

1. [Start up IJ Network Device Setup Utility.](#)

The detected printers are listed.

2. Select printer to display network information from printer list.

Select the printer with **Available** displayed on **Status**.

3. Select **Printer Network Information** on **View** menu.

The **Confirm Printer Password** screen appears.

For more on the password, refer to [Administrator Password](#).

4. Enter password and click **OK**.

The screen below appears.

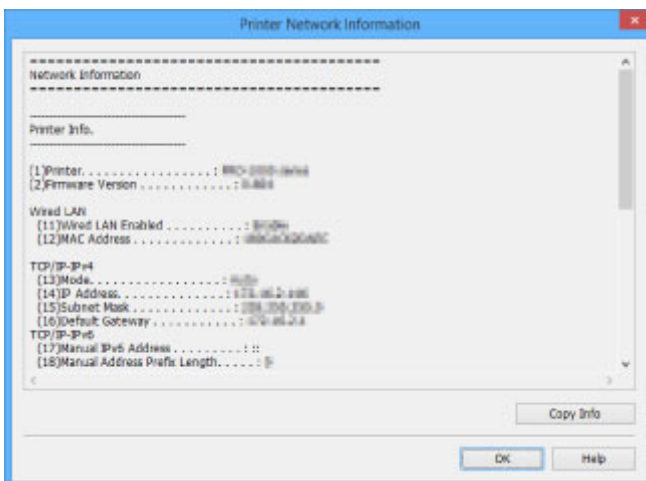

Clicking **Copy Info** copies all network information on the clipboard.

5. Click **OK** to close screen.

Checking Connection Status between Printer and Wireless Router

Follow the procedure below to check the wireless router information detected by the printer.

Detects wireless routers around the printer and the detected ones are listed. Use this menu to make sure whether the printer is located properly.

1. [Start up IJ Network Device Setup Utility.](#)

The detected printers are listed.

2. Select printer to check connection status between printer and wireless router from printer list.

Select the printer with **Available** displayed on **Status** and **Wireless LAN** displayed on **Connection Method**.

3. Select **Status of Printer and Wireless Router Connection** on **View** menu.

The **Confirm Printer Password** screen appears.

For more on the password, refer to [Administrator Password](#).

4. Enter password and click **OK**.

The screen below appears.

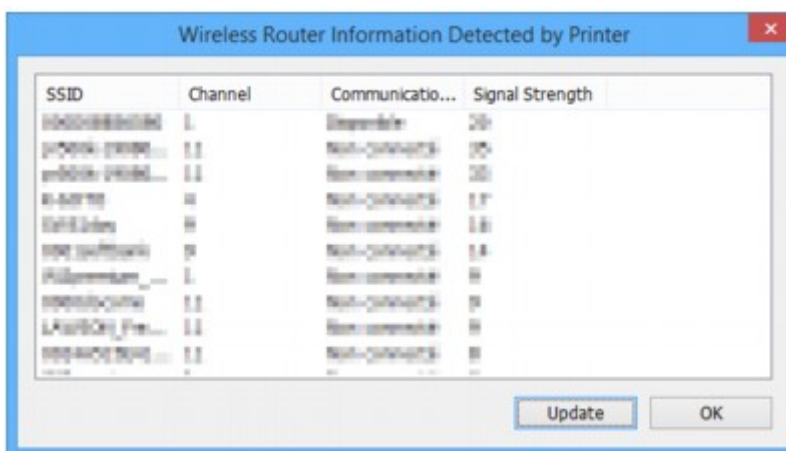

Clicking **Update** searches wireless routers again.

5. Click **OK** to close screen.

Checking Network Setting Difference

If you cannot use a printer you used on the network before, compare the current network status with that when you could use the printer and check the difference.

1. [Start up IJ Network Device Setup Utility.](#)

The detected printers are listed.

2. Select printer with **Unknown** or **Not Set** displayed on **Status** from printer list.
3. Select **Check Connection Status** on **View** menu.

The screen below appears.

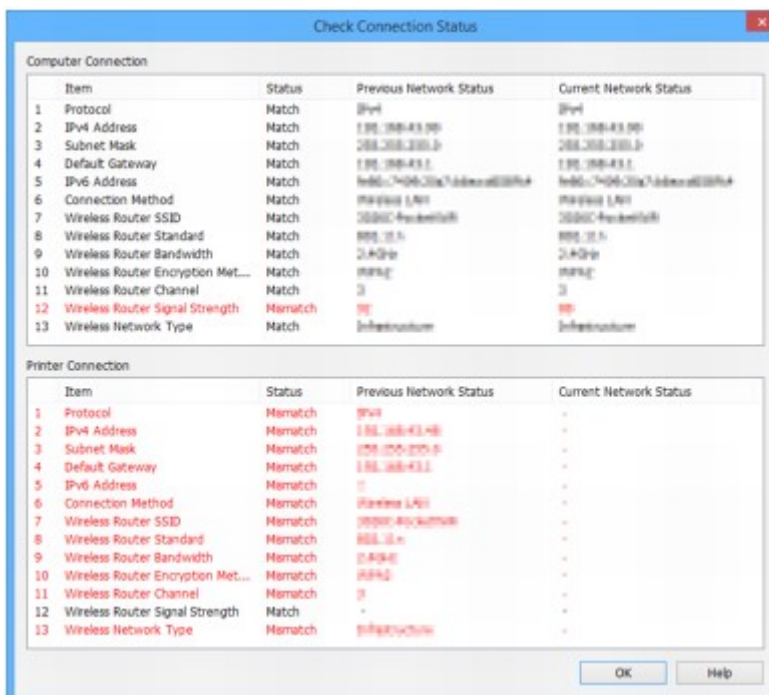

If the network status when you used the printer is different from the current status, **Mismatch** appears on **Status** and the items are displayed in red. Check the red items.

4. Click **OK** to close screen.

IJ Network Device Setup Utility Menus

- ▶ **Printer Menu**
- ▶ **View Menu**
- ▶ **Option Menu**
- ▶ **Help Menu**

Printer Menu

This section describes the items displayed on the **Printer** menu.

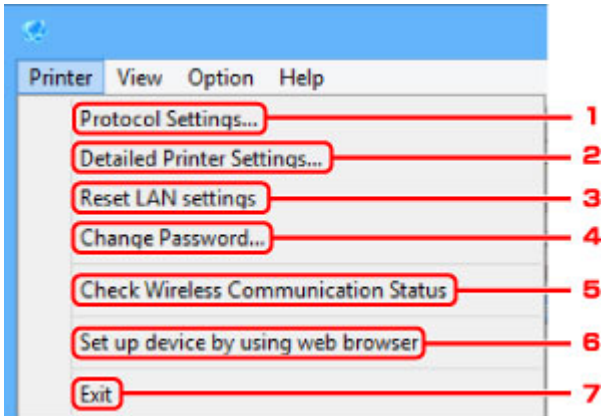

1. Protocol Settings...

Performs wired or wireless LAN settings.

- [Performing/Changing Wired LAN Settings](#)
- [Performing/Changing Wireless LAN Settings](#)

2. Detailed Printer Settings...

Assigns the printer device name and location name.

- [Assigning Printer Information](#)

3. Reset LAN settings

Initializes the printer LAN settings.

- [Initializing Network Settings](#)

4. Change Password...

Changes the password specified for the printer.

- [Changing Administrator Password](#)

5. Check Wireless Communication Status

Check wireless LAN communication status.

- [Checking Wireless Network Status](#)

6. Set up device by using web browser

Check the printer information or perform settings in detail on the web page.

▶▶▶ Note

- You can use this function on the following the OS and the web browser.
OS: Windows Vista SP2 or later

Web browser: Internet Explorer 9 or later, Google Chrome 41.0.2272.118m or later, Mozilla Firefox 37.0.1 or later

7. **Exit**

Finishes IJ Network Device Setup Utility.

View Menu

This section describes the items displayed on the **View** menu.

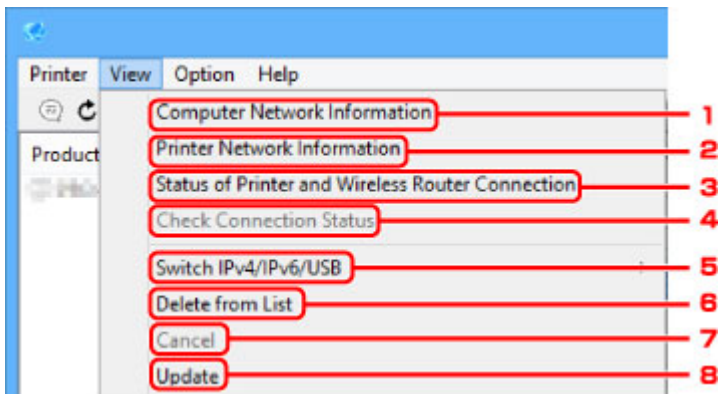

1. Computer Network Information

Check the computer network information.

■ [Displaying Computer Network Information](#)

2. Printer Network Information

Check the printer network information.

■ [Displaying Printer Network Information](#)

3. Status of Printer and Wireless Router Connection

Searches wireless routers and check the wireless router information (wireless channel, communication status, and signal strength) detected by the printer.

■ [Checking Connection Status between Printer and Wireless Router](#)

4. Check Connection Status

If you cannot use a printer you used on the network before, compare the current network status with that when you can use the printer and check the difference.

■ [Checking Network Setting Difference](#)

5. Switch IPv4/IPv6/USB

Switches the printer list between IPv4 printers and IPv6 printers. For some models, you can list USB connected printers.

6. Delete from List

Deletes the selected printer from the printer list.

7. Cancel

Cancels printer search.

»» Note

- You can also cancel printer search by clicking the  icon.

8. Update

Searches printers again.

»» Note

- You can also search printers again by clicking the  icon.

Option Menu

This section describes the items displayed on the **Option** menu.

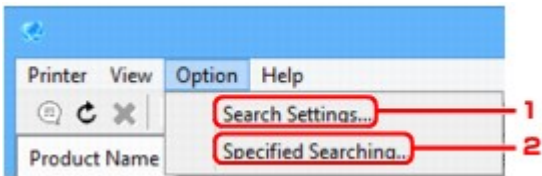

1. Search Settings...

Specifies criteria for printer search.

- [Setting Criteria for Printer Search](#)

2. Specified Searching...

Searches the printer by an IP address or host name.

- [Searching Specific Printer](#)

Help Menu

This section describes the items displayed on the **Help** menu.

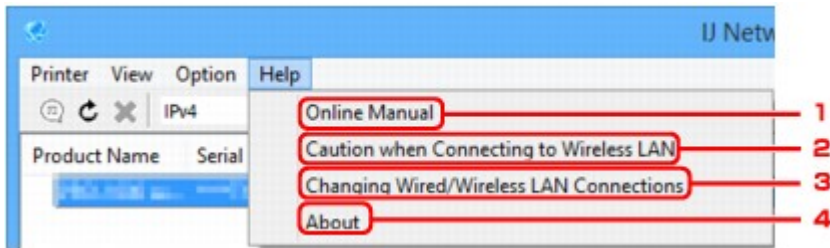

1. **Online Manual**

Displays this guide.

2. **Caution when Connecting to Wireless LAN**

Displays the caution message for wireless LAN connection.

3. **Changing Wired/Wireless LAN Connections**

Displays the message on changing LAN connection method (wired or wireless) for the selected printer.

4. **About**

Displays IJ Network Device Setup Utility version information.

Other Network Information

- ▶ [Technical Terms](#)
- ▶ [Restrictions](#)
- ▶ [Firewall](#)

Technical Terms

In this section, technical terms used in the manual are explained.

- [A](#)
- [B](#)
- [C](#)
- [D](#)
- [E](#)
- [H](#)
- [I](#)
- [K](#)
- [L](#)
- [M](#)
- [O](#)
- [P](#)
- [R](#)
- [S](#)
- [T](#)
- [U](#)
- [W](#)

A

- **Access point mode**

The printer is used as an access point to connect external wireless communication devices (e.g. computers, smartphones, or tablets) in an environment where no access point (wireless router) is available. You can connect up to 5 devices to the printer using the access point mode (direct connection).

- **Ad-hoc**

Client computer and printer setting where wireless communication occurs on a peer-to-peer basis, i.e., all clients in with the same SSID/network name communicate directly with each other. No wireless router is required. This printer does not support ad-hoc communication.

- **Admin Password**

Administrator password in IJ Network Device Setup Utility to restrict access to network users. It must be entered to access the printer and change printer settings.

- **AES**

An encryption method. It is optional for WPA. Strong cryptographic algorithm adopted within U.S. government organizations for information processing.

- **Authentication Method**

The method that a wireless router uses to authenticate a printer through a wireless LAN. The methods are agreeable each other.

For WPA/WPA2, authentication method is PSK.

B

- **Bonjour**

A service built into Mac OS X operating system to detect the connectable devices on a network automatically.

C

- **Cableless setup**

Specifies a wireless router settings using a device (e.g. smartphone) directly without using a wireless router.

- **Channel**

Frequency channel for wireless communication. In the infrastructure mode, the channel is automatically adjusted to match that set to the wireless router. This printer supports channels 1 to 13. (Channels 12 and 13 are not supported depending on the country or region of purchase.) Note that the number of channels that can be used for your wireless LAN varies depending on the region or country.

D

- **Default Gateway**

A relay device to connect to another network such as a router or a computer.

- **Default router address**

A default IP address set for a router.

- **DHCP server functionality**

The router assigns an IP address automatically whenever the printer or the personal computer on a network starts up.

- **DHCPv6**

A protocol to assign necessary information automatically when a computer connects to network. DHCPv6 can be used when IPv6 is enabled.

- **Direct connection (Access point mode)**

The printer is used as an access point to connect external wireless communication devices (e.g. computers, smartphones, or tablets) in an environment where no wireless router is available. You can connect up to 5 devices to the printer using the direct connection (access point mode).

- **DNS server**

A server that converts device names into IP addresses. When specifying IP addresses manually, specify the addresses of both a primary and a secondary server.

F

- **Firewall**

It is a system that prevents an unlawful computer access in the network. To prevent, you can use the firewall function of a broadband router, the security software installed in the computer, or operation system for computer.

H

- **Host name**

A name for a computer or printer on network so that it can be recognized easily. Single-byte alphanumeric characters are used generally.

I

- **IEEE802.11b**

International standard for wireless LAN using the 2.4 GHz frequency range with a throughput of up to 11 Mbps.

- **IEEE802.11g**

International standard for wireless LAN using the 2.4 GHz frequency range with a throughput of up to 54 Mbps. Compatible with 802.11b.

- **IEEE802.11n**

International standard for wireless LAN using the 2.4 GHz and 5 GHz frequency ranges. Even when using two or more antennas simultaneously or obtaining a bigger transfer rate than before by using multiple communication channels at the same time, the transmission speed may be influenced by the connected apparatus.

At the maximum transfer rate of 600 Mbps, it is possible to communicate with multiple computer terminals within a dozen or so metre radius.

Compatible with 802.11b and 802.11g.

- **Infrastructure**

One of the wireless communication methods. Wireless communication devices (e.g. computer or printer) are connected to the network via a wireless router.

- **IP Address**

A unique number with four parts separated by dots. Every network device that is connected to the Internet has an IP address. Example: 192.168.0.1

An IP address is usually assigned by a wireless router or a DHCP server of the router automatically.

- **IPv4/IPv6**

They are internetwork-layer protocol used on the internet. IPv4 uses 32-bit addresses and IPv6 uses 128-bit addresses.

K

- **Key Format**

Select either **ASCII** or **Hex** as the WEP key format. The character that can be used for the WEP key differs depending on the selected key formats.

- ASCII

Specify with a 5 or 13-character string that can include alphanumeric and underscore "_" characters. It is case-sensitive.

- Hex

Specify a 10-digit or 26-digit string that can contain hexadecimal (0 to 9, A to F, and a to f).

- **Key Length**

Length of the WEP key. Select either 64 bits or 128 bits. Longer key length allows you to set a more complex WEP key.

L

- **Link local address**

An IP address generated automatically from a specific prefix (information of current network: fe80::) and an interface identifier generated from printer's MAC address.

- **Link Quality**

The status of the connection between the wireless router and the printer excluding noise (interference) is indicated with a value from 0 to 100%.

- **LPR**

A platform-independent printing protocol used in TCP/IP networks. It does not support bidirectional communication.

M

- **MAC Address**

Also known as the physical address. A unique and permanent hardware identifier that is assigned to network devices by its manufacturer. MAC addresses are 48 bits long and are written as a hexadecimal number separated by colons, i.e., 11:22:33:44:55:66.

O

- **Operation Status**

Indicates the status on whether the printer can be used.

P

- **Prefix length**

The number of bits on the network part of an IP address. The number of bits is 8 bit to 24 bit for IPv4, and 64 bit for IPv6.

- **Proxy server**

A server that links a LAN-connected computer to the Internet. When using a proxy server, specify the address and the port number of the proxy server.

- **PSK**

An encryption method employed by WPA/WPA2.

R

- **Router**

A relay device to connect to another network.

S

- **Signal Strength**

The strength of the signal received by the printer from the wireless router is indicated with a value from 0 to 100%.

- **SSID**

Unique label for wireless LAN. It is often represented such as a network name or a wireless router name.

SSID distinguishes one wireless LAN from another to prevent interference.

The printer and all clients on a wireless LAN must use the same SSID in order to communicate with each other. The SSID can be up to 32 characters long, and is made up of alphanumeric characters. The SSID may also be referred to by its network name.

- **Stealth**

In the stealth mode, a wireless router hides itself by not broadcasting its SSID. The client must specify the SSID set to the wireless router to detect it.

- **Stateful address**

An IPv6 address acquired from a DHCP server using DHCPv6.

- **Stateless address**

A tentative IPv6 address generated automatically using a prefix included in RA (Router Advertisement) and a MAC address. An IPv6 address is generated in an environment where a DHCP server is not available.

- **Subnet Mask**

IP address has two components, the network address and the host address. Subnet Mask used to calculate the Subnet Mask address from the IP address. A Subnet Mask is usually assigned by a wireless router or a DHCP server of the router automatically.

Example:

IP Address: 192.168.127.123

Subnet Mask: 255.255.255.0

Subnet Mask Address: 192.168.127.0

T

- **TCP/IP**

Suite of communications protocols used to connect hosts on the Internet or the LAN. This protocol allows different terminals to communicate with each other.

- **TKIP**

An encryption protocol employed by WPA/WPA2.

U

- **USB**

Serial interface designed to enable you to "hot-swap" devices, i.e., by plugging and unplugging them without turning off the power.

W

- **WCN (Windows Connect Now)**

Users running Windows Vista or later can obtain the setting information directly via wireless network (WCN-NET).

- **WEP/WEP Key**

An encryption method employed by IEEE 802.11. Shared security key used to encrypt and decrypt data sent over wireless networks. This printer supports key length of 64 bits or 128 bits, key format of ASCII code or Hexadecimal, and key number of 1 to 4.

- **Wi-Fi**

International association that certifies interoperability of wireless LAN products based on the IEEE 802.11 specification.

This printer is a Wi-Fi authorized product.

- **Wireless LAN**

A network that, instead of being connected by physical wires, is connected by a wireless technology, such as Wi-Fi.

- **Wireless Router**

A wireless transceiver or base station that receives information from wireless clients/the printer and rebroadcasts it. Required in an infrastructure network.

- **WPA**

Security framework announced by the Wi-Fi Alliance in October 2002. The security has been strengthened more than WEP.

- Authentication

WPA defines the following authentication methods: PSK that can be used without an authentication server, plus WPA-802.1x that do require an authentication server.

This printer supports WPA-PSK.

- Passphrase

This encrypted key is used to perform WPA-PSK authentication.

The passphrase should be a string of 8 to 63 alphanumeric characters or a 64-digit hexadecimal value.

- **WPA2**

Security framework released by the Wi-Fi Alliance in September 2004 as a later version of WPA. Provides a stronger encryption mechanism through Advanced Encryption Standard (AES).

- Authentication

WPA2 defines the following authentication methods: PSK that can be used without an authentication server, plus WPA2-802.1x that do require an authentication server.

This printer supports WPA2-PSK.

- Passphrase

This encrypted key is used to perform WPA2-PSK authentication.

The passphrase should be a string of 8 to 63 alphanumeric characters or a 64-digit hexadecimal value.

- **WPS (Wi-Fi Protected Setup)**

WPS is a standard for easy and secure establishment of a wireless network.

There are 2 primary methods used in the Wi-Fi Protected Setup:

PIN entry: a mandatory method of setup for all WPS certified devices

Push button configuration (PBC): an actual push button on the hardware or through a simulated push button in the software.

Restrictions

If you use a printer over the wireless LAN, the printer may recognize nearby wireless systems, you should set a network key (WEP or WPA/WPA2) to the access point to encrypt wireless transmission. Wireless communication with a product that does not comply with the Wi-Fi standard cannot be guaranteed.

Connecting with too many computers may affect the printer performance, such as printing speed.

If you use a printer with direct connection, you cannot perform the following settings:

- Specifying an IP address manually
- Enabling/disabling IPv6

Firewall

A firewall is a function of the security software installed in the computer or operation system for computer, and is a system that is designed to prevent unauthorized access to a network.

Precautions When Firewall Function is Enabled

- A firewall function may limit communications between a printer and a computer. This may disable printer setup and communications.
- During the printer setup, you may be prompted to enable or disable communications, depending on the firewall function of the security software or operation system. If so, choose to enable communications.
- When using IJ Network Device Setup Utility, you may be prompted to enable or disable communications, depending on the firewall function of the security software. If so, choose to enable communications.
- If you cannot set up the printer, temporarily disable the firewall function of the security software or operation system.

Important

- If you disabled the firewall function, disconnect your network from the Internet.
- Some applications (like the network configuration software) override firewall settings. Check the application's settings beforehand.
- If the printer you use is set to **Get IP address automatically**, the IP address changes every time the printer connects to the network. This may disable printer setup and communications, depending on the firewall settings. In this case, either change the firewall settings or assign a fixed IP address to the printer. An IP address can be set using IJ Network Device Setup Utility.
 - [Performing/Changing Wired LAN Settings](#)
 - [Performing/Changing Wireless LAN Settings](#)

When assigning a fixed IP address to the printer, you will need to specify an IP address with which the computer can communicate.

Note

- For the operation system firewall settings or the security software firewall settings, refer to the instruction manual of the computer or software, or contact its manufacturer.

Ensuring Optimal Printing Results

- ▶ **Ink Tips**
- ▶ **Printing Tips**
- ▶ **Check Paper Settings Before Printing**
- ▶ **Set Cassette Paper Information After Loading Paper**
- ▶ **Canceling Print Jobs**
- ▶ **Keeping Print Quality High**
- ▶ **Transporting Your Printer**

Ink Tips

Is ink consumed for purposes other than printing?

Ink is sometimes consumed for purposes other than printing.

When you use the Canon printer for the first time after you install the bundled ink tanks, the printer consumes a small amount of ink in the amount to enable printing by filling the nozzles of the Print Head with ink.

The printing costs described in the brochures or websites are based on the consumption data from not the first ink tank /ink cartridge but the succeeding ink tank /ink cartridge.

Ink is sometimes used to maintain the optimal printing quality.

To keep printer's performance, Canon printer performs cleaning automatically according to its condition. When the printer performs cleaning, a small amount of ink is consumed. In this case, all colors of ink may be consumed.

[Cleaning function]

The cleaning function helps the printer to suck air bubbles or ink itself from the nozzle and thus prevents print quality degradation or nozzle clogging.

Is color ink consumed for black-and-white printing?

Black-and-white printing may consume ink in colors other than black, depending on the type of paper and printer driver settings used. Color ink is therefore consumed in some cases even for black-and-white print jobs.

▶▶ Note

- The printer uses pigment ink. With pigment ink, some ink on printed surfaces may come off when rubbed or scratched.

Printing Tips

Check status before printing

- Is the print head in good condition?

Clogged print head nozzles make printing fainter, which affects print quality and wastes paper. To check the print head, print the nozzle check pattern.

■ [Maintenance Procedure](#)

- Is the inside of the printer smeared with ink?

After many print jobs, areas where paper passes through the printer may become smeared with ink. To clean the inside the printer, perform [Bottom Plate Cleaning](#).

Check how to load the paper correctly!

- Is the paper loaded in the correct orientation?

To load paper in a cassette, load paper printing-side DOWN.

■ [Loading Paper](#)

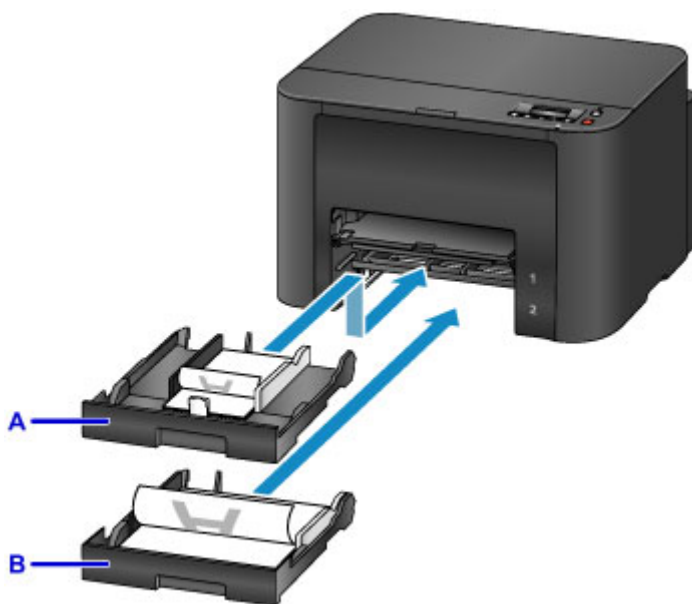

A: cassette 1

B: cassette 2

- Is the paper curled?

The curled paper causes paper jam. Flatten the curled paper, and then reload it.

■ "Correct curl before loading paper." in [Paper Is Smudged / Printed Surface Is Scratched](#)

Check Paper Settings Before Printing

Before printing, complete paper settings from a computer.

Paper comes in many varieties. Some is specially coated for high-quality photo printing, while other paper is designed for documents.

Each type of paper has specific preset settings that determine details such as ink application and usage and the distance from nozzles, which ensures optimal print quality for the paper. In contrast, incorrect paper settings may impair color performance, or printed surfaces may rub against the printer.

If printing seems blurry or colors uneven, try printing again at a higher print quality setting.

Set Cassette Paper Information After Loading Paper

When you insert a cassette after loading paper, a screen for setting the type and size of paper is displayed. Set the paper information for the cassette, indicating the type and size of paper loaded.

To prevent incorrect printing, the printer can compare paper information entered for the cassette to print job paper settings to ensure they match. Before printing, specify paper settings consistent with the cassette paper information. If these settings do not match, automatic paper checking (if enabled) will prevent incorrect printing and display an error message. In this case, check and correct the paper settings.

To check cassette paper information, display the paper information screen on the operation panel.

Canceling Print Jobs

Do not press the ON button to cancel print jobs

Pressing the **ON** button to turn off the printer during printing may prevent the printer from printing again if print jobs are not cleared internally.

Press the **Stop** button to cancel printing.

Keeping Print Quality High

The key to maintaining optimal print quality is preventing the print head from drying out or becoming clogged. To ensure print quality, follow these tips.

»» Note

- On some paper, ink may run if you mark over it with a highlighter or water-based marker, or if water or sweat comes into contact with printed areas.

Never unplug the printer until it is off

Pressing the **ON** button to turn off the printer will automatically cap the print head (which is equipped with nozzles) to prevent it from drying out. However, capping is not performed if you unplug the printer while the **POWER** lamp is lit or flashing. This may cause drying or clogging.

Before [unplugging the printer](#), make sure the **POWER** lamp is not lit.

Print regularly

Just as felt-tip pens dry up and become unusable (even when capped) if not used over extended periods, the print head may dry out or become clogged if the printer is not used for some time. Use the printer at least once a month, if possible.

Allow regular ink mixing

The printer automatically mixes ink periodically to maintain optimal print quality. Regular printing helps keep the ink in good condition.

If the printer is not used for some time, it will automatically mix the ink before printing.

Transporting Your Printer

Take these precautions when relocating the printer for changing your living place or repairing it.

►►► Important

- Place the printer upright in a sturdy box and pack it with sufficient cushioning to protect it in transit.
- With the print head and ink tank set still installed, press the **ON** button to turn off the printer. This enables automatic capping of the print head, which prevents it from drying out.
- After packing, do not tilt the box, tip it over, or turn it upside down. This may damage the printer and cause ink leakage in transit.
- When shipping the printer via a courier service, label the box "THIS SIDE UP". Also label the box "FRAGILE" or "HANDLE WITH CARE".

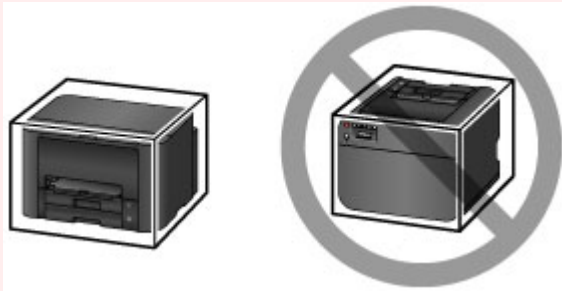

1. Turn the printer off.
2. After confirming that the **POWER** lamp is off, [unplug the printer](#).

►►► Important

- Do not unplug the printer while the **POWER** lamp is lit or flashing. This may damage the printer or cause it to malfunction, which may prevent you from printing.

3. Take out the cassettes and remove the paper. Shorten the cassettes in preparation for stowing them inside.

■ [Paper Sources](#)

4. Close the paper output support, and then push in the output tray extension and paper output tray.
5. Reinsert the cassettes.
6. Disconnect all cables and the power cord from the printer.
7. Tape down all covers on the printer to prevent them from opening, and to prevent the cassettes from coming out in transit. Place the printer in a plastic bag.
8. In the box, surround the printer with cushioning material to protect it.

Legal Restrictions on Printing

Printing or modifying printed copies of the following may be punishable under law.

This list is non-exhaustive. When in doubt, check with a local legal representative.

- Paper money
- Money orders
- Certificates of deposit
- Postage stamps (canceled or uncanceled)
- Identification badges or insignia
- Selective service or draft papers
- Checks or drafts issued by governmental agencies
- Motor vehicle licenses and certificates of title
- Traveler's checks
- Food stamps
- Passports
- Immigration papers
- Internal revenue stamps (canceled or uncanceled)
- Bonds or other certificates of indebtedness
- Stock certificates
- Copyrighted works or works of art, without the owner's consent

Specifications

General Specifications

Printing resolution (dpi)	600 (horizontal) x 1200 (vertical)
Interface	<p>USB Port: Hi-Speed USB *1</p> <p>LAN Port: Wired LAN: 100BASE-TX / 10BASE-T Wireless LAN: IEEE802.11n / IEEE802.11g / IEEE802.11b *2</p> <p>*1 A computer that complies with Hi-Speed USB standard is required. Since the Hi-Speed USB interface is fully upwardly compatible with USB 1.1, it can be used at USB 1.1.</p> <p>*2 Setup possible through WPS (Wi-Fi Protected Setup), WCN (Windows Connect Now) or Cableless setup.</p> <p>USB and LAN can be used at the same time. Wireless LAN and wired LAN cannot be used at the same time.</p>
Print width	8 inches/203.2 mm
Operating environment	<p>Temperature: 41 to 95 °F (5 to 35 °C) Humidity: 10 to 90 % RH (no condensation)</p> <p>* The performance of the printer may be reduced under certain temperature and humidity conditions. Recommended conditions: Temperature: 59 to 86 °F (15 to 30 °C) Humidity: 10 to 80 % RH (no condensation)</p> <p>* For the temperature and humidity conditions of papers such as photo paper, refer to the paper's packaging or the supplied instructions.</p>
Storage environment	<p>Temperature: 32 to 104 °F (0 to 40 °C) Humidity: 5 to 95 % RH (no condensation)</p>
Power supply	AC 100-240 V, 50/60 Hz
Power consumption	<p>Printing: Approx. 27 W Standby (minimum): Approx. 0.9 W *1*2 OFF: Approx. 0.3 W *1</p> <p>*1 USB connection to PC *2 The wait time for standby cannot be changed.</p>
External dimensions	<p>Approx. 18.3 (W) x 15.5 (D) x 11.5 (H) inches Approx. 463 (W) x 394 (D) x 290 (H) mm</p> <p>* With the Paper Output Tray and Cassettes retracted.</p>
Weight	Approx. 21.2 lb (Approx. 9.6 kg)

	* With the Print Head and ink tanks installed.
Print Head/Ink	Total 4352 nozzles (BK 1280 nozzles, C/M/Y 512 x 6 nozzles)

Network Specifications

Communication protocol	SNMP (supports Canon-MIB), TCP/IP
Wired LAN	Supported Standards: IEEE802.3u (100BASE-TX) / IEEE802.3 (10BASE-T) Transfer speed: 10 M/100 Mbps (auto switching)
Wireless LAN	Supported Standards: IEEE802.11n / IEEE802.11g / IEEE802.11b Frequency bandwidth: 2.4 GHz Channel: 1-11 or 1-13 * Frequency bandwidth and available channels differ depending on country or region. Communication distance: Indoors 164 feet/50 m * Effective range varies depending on the installation environment and location. Security: WEP (64/128 bits) WPA-PSK (TKIP/AES) WPA2-PSK (TKIP/AES) Setup: WPS (Push button configuration/PIN code method) WCN (WCN-NET) Cableless setup Other Features: Administration password

Minimum System Requirements

Conform to the operating system's requirements when higher than those given here.

Windows

Operating System	Windows 10, Windows 8.1*, Windows 8 Windows 7, Windows 7 SP1 Windows Vista SP2 * Windows 8.1 includes Windows 8.1 Update. For the printer driver, Quick Utility Toolbox, and IJ Network Device Setup Utility: Windows Server 2008, Windows Server 2008 R2, Windows Server 2012, and Windows Server 2012 R2
Hard Disk Space	3.1 GB Note: For bundled software installation.

	The necessary amount of hard disk space may be changed without notice.
Display	XGA 1024 x 768

Mac OS

Operating System	OS X v10.8.5 - OS X v10.11
Hard Disk Space	1.5 GB Note: For bundled software installation. The necessary amount of hard disk space may be changed without notice.
Display	XGA 1024 x 768

Other Supported OS

Some functions may not be available with each OS. Refer to the Canon web site for details on operation with iOS, Android, and Windows RT.

Mobile Printing Capability

Apple AirPrint
Google Cloud Print
MAXIFY Cloud Link

- An internet connection is required to use Easy-WebPrint EX and all the Online Manual.
- Windows: Operation can only be guaranteed on a computer with Windows 10, Windows 8.1, Windows 8, Windows 7 or Windows Vista pre-installed.
- Windows: A CD-ROM Drive or internet connection is required during software installation.
- Windows: Internet Explorer 8, 9, 10 or 11 is required to install Easy-WebPrint EX.
- Windows: Some functions may not be available with Windows Media Center.
- Windows: .NET Framework 4 or 4.5 must be installed to use the Windows software.
- Mac OS: For Mac OS, an internet connection is required during software installation.
- In an in-house network environment, the 5222 port must be open. Contact the network administrator for details.

Information in this guide is subject to change without notice.

Information about Paper

▶ Supported Media Types

- Paper Load Limit

▶ Unsupported Media Types

▶ Handling Paper

▶ Print Area

- Print Area
- Standard Sizes
- Envelopes

Supported Media Types

For best results, choose paper designed for how you are printing. A variety of paper for documents as well as photos or illustrations is available from Canon. Use genuine Canon paper to print important photos, when possible.

Media Types

Genuine Canon paper

▶▶▶ Note

- For warnings on use of the non-printable side, see each product's usage information.
- For details on page sizes and media types, access the Canon website.
- Genuine Canon paper is not available in some countries or regions. Note that in the United States, Canon paper is not sold by model number. Instead, purchase paper by name.

Paper for printing documents:

- Canon Red Label Superior <WOP111>
- Canon Océ Office Colour Paper <SAT213>
- High Resolution Paper <HR-101N>

Paper for printing photos:

- Glossy Photo Paper "Everyday Use" <GP-501/GP-601>
- Photo Paper Glossy <GP-601>
- Photo Paper Plus Glossy II <PP-201>
- Photo Paper Pro Luster <LU-101>
- Photo Paper Plus Semi-gloss <SG-201>
- Matte Photo Paper <MP-101>

Paper other than genuine Canon paper

- Plain Paper (including recycled paper)
- Envelopes
- Label Paper

■ [Paper Load Limit](#)

■ [Paper Settings on the Printer Driver and the Printer \(Media Type\)](#) (Windows)

■ [Paper Settings on the Printer Driver and the Printer \(Media Type\)](#) (Mac OS)

Page Sizes

You can use the following page sizes.

▶▶▶ Note

- Page sizes and media types the printer supports differ depending on the OS you are using.

Standard sizes:

- Letter

- Legal
- Executive (7.25 x 10.5 inches (184.2 x 266.7 mm))
- A4
- B5
- A5
- A6
- Oficio (8.5 x 12.5 inches (215.9 x 317.5 mm))
- B-Oficio (8.5 x 14 inches (216.0 x 355.0 mm))
- M-Oficio (8.50 x 13.43 inches (216.0 x 341.0 mm))
- Foolscap (8.5 x 13 inches (215.9 x 330.2 mm))
- Legal(India) (8.46 x 13.58 inches (215 x 345 mm))
- L(89x127mm)
- KG/4"x6"(10x15)
- 2L/5"x7"(13x18)
- Hagaki
- Hagaki 2
- 8"x10"(20x25cm)
- Envelope Com 10
- Envelope DL
- Nagagata 3
- Nagagata 4
- Yougata 4
- Yougata 6
- Envelope C5
- Envelope Monarch (3.88 x 7.5 inches (98.4 x 190.5 mm))

Special sizes

Special page sizes must be within the following limits:

- cassette 1
 - Minimum size: 3.50 x 5.00 inches (89.0 x 127.0 mm)
 - Maximum size: 8.50 x 14.00 inches (216.0 x 355.6 mm)
- cassette 2
 - Minimum size: 8.27 x 11.00 inches (210.0 x 279.4 mm)
 - Maximum size: 8.50 x 14.00 inches (216.0 x 355.6 mm)

Paper Weight

You can use paper in the following weight range.

- 17 to 28 lb (64 to 105 g /m²) (plain paper other than genuine Canon paper)

Paper Load Limit

Genuine Canon Paper

Paper for printing documents:

Media Name <Model No.>	Cassette 1	Cassette 2	Paper Output Tray
Canon Red Label Superior <WOP111>	Approx. 250 sheets	Approx. 250 sheets	Approx. 75 sheets
Canon Océ Office Colour Paper <SAT213>	Approx. 200 sheets	Approx. 200 sheets	Approx. 75 sheets
High Resolution Paper <HR-101N>	65 sheets	N/A*1	65 sheets

Paper for printing photos:

▶▶▶ Note

- Feeding the following paper from cassette 2 may damage the printer. Always load in cassette 1.
- For best results in continuous printing, remove printed sheets from the paper output tray to avoid smearing or discoloration.

Media Name <Model No.>	Cassette 1
Glossy Photo Paper "Everyday Use" <GP-501/GP-601>*2	A4, Letter: 10 sheets 4" x 6" (10 x 15 cm): 20 sheets
Photo Paper Glossy <GP-601>*2	A4, Letter: 10 sheets 4" x 6" (10 x 15 cm): 20 sheets
Photo Paper Plus Glossy II <PP-201>*2	A4, Letter, 5" x 7" (13 x 18 cm), 8" x 10" (20 x 25 cm): 10 sheets 4" x 6" (10 x 15 cm): 20 sheets
Photo Paper Pro Luster <LU-101>*2	A4, Letter: 10 sheets
Photo Paper Plus Semi-gloss <SG-201>*2	A4, Letter, 5" x 7" (13 x 18 cm), 8" x 10" (20 x 25 cm): 10 sheets 4" x 6" (10 x 15 cm): 20 sheets
Matte Photo Paper <MP-101>	A4, Letter: 10 sheets 4" x 6" (10 x 15 cm): 20 sheets

Paper other than Genuine Canon Paper

Common Name	Cassette 1	Cassette 2	Paper Output Tray
Plain Paper (including recycled paper)*3	Approx. 250 sheets	Approx. 250 sheets	Approx. 75 sheets
Envelopes	10 envelopes	N/A*1	*4
Label Paper	10 sheets	N/A*1	*4

*1 Feeding paper and envelopes from cassette 2 may damage the printer. Always load in cassette 1.

- *2 Feeding from a loaded stack of paper may leave marks on the printed side or prevent efficient feeding. In this case, load one sheet at a time.
- *3 Normal feeding at maximum capacity may not be possible with some types of paper, or under very high or low temperature or humidity. In this case, load half the amount of paper or less.
- *4 For best results in continuous printing, remove printed paper or envelopes from the paper output tray to avoid smearing or discoloration.

Unsupported Media Types

Do not use the following paper. Not only will print quality be poor, the paper may jam or cause the printer to malfunction.

- Paper that is folded, curled, or wrinkled
- Paper that is damp
- Plain paper or notepad paper cut to a smaller size
- Picture postcards
- Postcards with photos or stickers attached
- Envelopes with a double flap
- Envelopes with embossed or coated surfaces
- Envelopes with adhesive flaps that are already moistened
- Any paper with holes
- Non-rectangular paper
- Stapled or glued paper
- Paper with an adhesive surface
- Paper coated with glitter or other decorative particles

Handling Paper

- Be careful not to rub or scratch the surfaces of any types of paper when handling.
- Hold the paper as closely as possible to its edges and try not to touch the printing surface. The print quality may be degraded if the printing surface is smudged with sweat or oil that comes from your hands.
- Do not touch the printed surface until the ink is dried. Even when the ink is dried, be careful not to touch the printed surface as much as possible when handling. Due to the nature of the pigment ink, the ink on the printed surface may be removed when being rubbed or scratched.
- Take out only the necessary number of paper from the package, just before printing.
- To avoid curling, when you do not print, put unused paper back into the package and keep it on a level surface. And also, store it avoiding heat, humidity, and direct sunlight.

Print Area

- ▶ **Print Area**
- ▶ **Standard Sizes**
- ▶ **Envelopes**

Print Area

To maintain print quality, the printer leaves a margin around the edges of paper. The printable area is inside this margin.

 (recommended print area): Print within this area, when possible.

 (printable area): You can also print in this area. However, feeding precision or print quality may be affected.

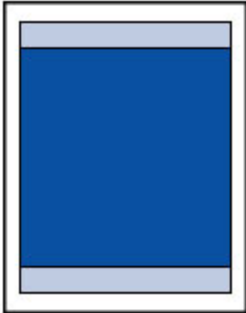



Note

- Automatic duplex printing reduces the printable area by 0.08 inch (2 mm) in the top margin.

Standard Sizes

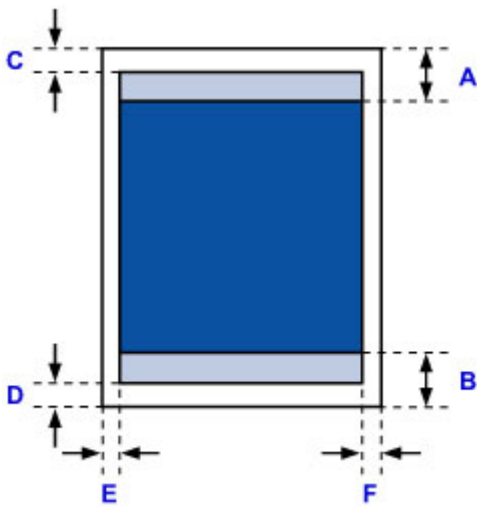
Size	Print Area (width x height)
Letter	8.00 x 10.69 inches (203.2 x 271.4 mm)
Legal	8.00 x 13.69 inches (203.2 x 347.6 mm)
Executive	6.98 x 10.19 inches (177.4 x 258.7 mm)
A6	3.87 x 5.51 inches (98.2 x 140.0 mm)
A5	5.56 x 7.95 inches (141.2 x 202.0 mm)
A4	8.00 x 11.38 inches (203.2 x 289.0 mm)
B5	6.90 x 9.80 inches (175.2 x 249.0 mm)
Oficio	8.00 x 12.09 inches (203.2 x 307.0 mm)
B-Oficio	8.00 x 13.66 inches (203.2 x 347.0 mm)
M-Oficio	8.00 x 13.11 inches (203.2 x 333.0 mm)
Foolscap	8.00 x 12.69 inches (203.2 x 322.2 mm)
Legal (India)	8.00 x 13.27 inches (203.2 x 337.0 mm)
4" x 6" (10 x 15 cm)	3.73 x 5.69 inches (94.8 x 144.4 mm)
5" x 7" (13 x 18 cm)	4.73 x 6.69 inches (120.2 x 169.8 mm)
8" x 10" (20 x 25 cm)	7.73 x 9.69 inches (196.4 x 246.0 mm)



 Recommended print area

A: 1.80 inches (45.8 mm)

B: 1.45 inches (36.8 mm)

 Printable area

Executive, A6, A5, A4, B5, 4" x 6" (10 x 15 cm), 5" x 7" (13 x 18 cm), 8" x 10" (20 x 25 cm)

C: 0.12 inch (3.0 mm)

D: 0.20 inch (5.0 mm)

E: 0.13 inch (3.4 mm)

F: 0.13 inch (3.4 mm)

Letter, Legal, Foolscap

C: 0.12 inch (3.0 mm)

D: 0.20 inch (5.0 mm)

E: 0.25 inch (6.4 mm)

F: 0.25 inch (6.3 mm)

Legal (India)

C: 0.12 inch (3.0 mm)

D: 0.20 inch (5.0 mm)

E: 0.23 inch (5.9 mm)

F: 0.23 inch (5.9 mm)

Oficio

C: 0.12 inch (3.0 mm)

D: 0.30 inch (7.5 mm)

E: 0.25 inch (6.4 mm)

F: 0.25 inch (6.3 mm)

B-Oficio, M-Oficio

C: 0.12 inch (3.0 mm)

D: 0.20 inch (5.0 mm)

E: 0.25 inch (6.4 mm)

F: 0.25 inch (6.4 mm)

Envelopes

Size	Recommended Print Area (width x height)
Envelope Com 10	3.68 x 8.50 inches (93.5 x 215.9 mm)
Envelope DL	3.88 x 7.67 inches (98.8 x 194.6 mm)
Envelope C5	5.94 x 8.02 inches (150.8 x 203.6 mm)
Envelope Monarch	3.43 x 6.50 inches (87.2 x 165.1 mm)

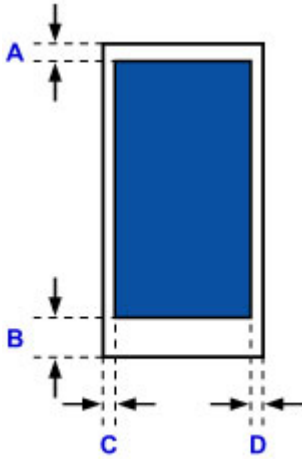

 Recommended print area

A: 0.5 inch (12.7 mm)

B: 0.5 inch (12.7 mm)

C: 0.22 inch (5.6 mm)

D: 0.22 inch (5.6 mm)

Administrator Settings

- ▶ [Sharing the Printer on a Network](#)

Sharing the Printer on a Network

When computers are used in a network environment, documents can be printed from multiple computers that share a single printer.

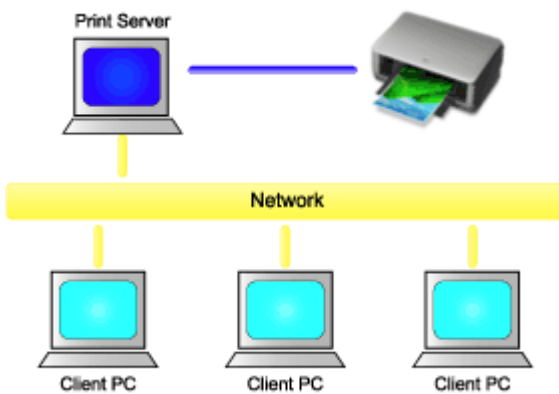

- [Setting Up a Shared Printer](#)

This section describes how to set up the print server and the client.

►►► Note

- The Windows versions of the computers connected to the network do not necessarily have to be the same.
- To set up the fax driver, use the same procedure.

Related Topic

- [Restrictions on Printer Sharing](#)

Setting Up a Shared Printer

On the print server, set up sharing of the printer driver. Then from the client, set up the connection to the print server.

1. [Install the printer driver](#) on the print server system

2. Select as described below:

- If you are using Windows 10, Windows 8.1, Windows 8, Windows 7, Windows Server 2012 R2, Windows Server 2012, or Windows Server 2008 R2, select the **Control Panel -> Hardware and Sound (Hardware) -> Devices and Printers**
The **Devices and Printers** window is displayed.
- If you are using Windows Vista or Windows Server 2008, select the **Control Panel -> Hardware and Sound -> Printers**
The **Printers** window is displayed.

3. Click the icon for the model name of printer to be shared

- If you are using Windows 10, Windows 8.1, Windows 8, Windows 7, Windows Server 2012 R2, Windows Server 2012, or Windows Server 2008 R2, press the Alt key, and from the displayed **File** menu, select **Printer properties -> Sharing** tab.
- If you are using Windows Vista, press the Alt key, and from the displayed **File** menu, select **Run as administrator -> Sharing...**
- If you are using Windows Server 2008 select **Sharing...** from the **File** menu.

Important

- A confirmation/warning dialog box may appear when starting, installing or uninstalling software. This dialog box appears when administrative rights are required to perform a task. When you are logged on to an administrator account, click **Yes** (or **Continue, Allow**) to continue. Some applications require an administrator account to continue. In such cases, switch to an administrator account, and restart the operation from the beginning.

4. Set sharing

On the **Sharing** tab, check (or select) **Share this printer**, set the shared name as necessary, and then click **OK**.

5. If the print server and the client have different architectures (32 bit or 64 bit), install an additional driver

1. Display the **Devices and Printers, Printers, or Printers and Faxes** window.
2. Select as described below:
 - If you are using Windows 10, Windows 8.1, Windows 8, Windows 7, Windows Server 2012 R2, Windows Server 2012, or Windows Server 2008 R2, select the printer icon, click **Print server properties**, and select the **Drivers** tab
 - If you are using Windows Vista, press the Alt key, and from the displayed **File** menu, select **Run as administrator -> Server Properties...**, and select the **Drivers** tab

- If you are using Windows Server 2008 from the **File** menu, open **Server Properties**, and select the **Drivers** tab
3. Click **Add...**
 4. When the **Add Printer Driver Wizard** window is displayed, click **Next**.
 5. If the print server has a 32-bit architecture, select **x64**. If the print server has a 64-bit architecture, select **x86**. Then click **Next**.
 6. Click **Have Disk...**
 7. In the **Install From Disk** window, open the "Driver" folder of the downloaded printer driver, specify the ".inf" file, and click **OK**.
 8. Select the printer to be used, and click **Next**.

▶▶▶ Note

- If an error message is displayed, select the other printer.

9. Click **Finish**

The setup on the print server system is complete. Next, set up the client systems.

6. On the client, open Explorer, and double-click the icon of the printer to be shared
7. Follow the window instructions, and install the printer driver

The setup on the client system is complete.

Even when you perform the setup on a different client, follow the same steps 6 and 7.

Restrictions on Printer Sharing

If you are using the XPS printer driver, replace "Canon IJ Preview" with "Canon IJ XPS Preview" when reading this information.

These are restrictions that apply when you are using a printer in a network environment. Check the restrictions for the environment you are using.

Restriction on setting up printer sharing

- If "ntprint.inf" is requested when you install the driver from **Add Printer**, specify the file as follows:
 1. Start Explorer on the print server and on the client with the different architecture, paste the following path in the address bar, and press Enter on the keyboard:
%windir%\system32\driverstore\
 2. Right-click the **FileRepository** folder, and click **Properties**.
 3. On the **Sharing** tab, click **Share**.
 4. In the message window displayed on the print server, specify "ntprint.inf_xxxxxxx" in the folder that was shared in step 3, and click **OK**.
If there are multiples copies, select the file with the latest update date and time.

Restrictions on sharing and using a printer

- A print completion message may be displayed. To disable the message display, follow the procedure below.
 - If you are using Windows 10, Windows 8.1, Windows 8, Windows Server 2012 R2, or Windows Server 2012:
In the **Devices and Printers** window of the client system, select the printer from **Printers**, and click **Print server properties** on the command bar.
Uncheck **Show informational notifications for network printers** on the **Advanced** tab, and then restart the computer.
 - If you are using Windows 7 or Windows Server 2008 R2:
In the **Devices and Printers** window of the client system, select the printer from **Printers and Faxes**, and click **Print server properties** on the command bar.
Uncheck **Show informational notifications for network printers** on the **Advanced** tab, and then restart the computer.
 - If you are using Windows Vista:
In the **Printers** window of the client system, press the Alt key, and from the displayed **File** menu, click **Run as administrator -> Server Properties...**
Uncheck **Show informational notifications for network printers** on the **Advanced** tab, and then restart the computer.
 - If you are using Windows Server 2008:
In the **Printers** window of the client system, click **Server Properties...** from the **File** menu.
Uncheck **Show informational notifications for network printers** on the **Advanced** tab, and then restart the computer.
- The bi-directional communication function is disabled and the correct printer status may not be recognized.
If a client user opens the printer driver properties and then clicks **OK** with the **Enable bidirectional**

support check box cleared on the **Ports** tab, the bidirectional communication function of the print server may also be disabled.

In this case, check **Enable bidirectional support** check box on both the print server system and the client system.

- When you print from a client system, you cannot use Canon IJ Preview.
- When the functions on the **Maintenance** tab cannot be set properly from a client system, they may be grayed out. In this case, change the settings from the print server.
When you change the settings of the print server, you should delete the icon of the shared printer from the client system, and then specify the shared settings again in the client system.
- If the same driver installed on the print server is also installed on the client, the network printer icon may be created automatically.
- If an error occurs when you print a document on a shared printer from a client, the error message of the Canon IJ status monitor is displayed on both the client and the print server. If a document is printed out normally, the Canon IJ status monitor is displayed only on the client.

Administrator Password

Depending on the printer you are using, an administrator password is specified at the time of purchase. The password is either "canon" or the printer serial number if it is specified.

Model whose administrator password is specified as "canon":

MG7500 series, MG6700 series, MG6600 series, MG5600 series

MG2900 series, MX490 series, MB5300 series, MB5000 series

MB2300 series, MB2000 series, E480 series, E460 series

iP110 series, iB4000 series, PRO-100S series, PRO-10S series

- At the time of purchase, the user name "ADMIN" is also specified for the models above.
- The following character restrictions apply to the password that you change:
 - Set the password by using 0 to 32 characters.
 - The allowed characters are single-byte alphanumeric characters.
- For security reasons, we recommend you use 6 and more alphanumeric characters.

Model whose serial number is used as the administrator password:

- For the models other than the above, the printer serial number is used as the administrator password.

■ [Where Serial Number Is Located](#)

- The following character restrictions apply to the password that you change:
 - Set the password by using 4 to 32 characters.
 - The allowed characters are single-byte alphanumeric characters.
- For security reasons, we recommend you use 6 and more alphanumeric characters.

▶▶ Important

- You can change the password using one of the tools below. (Some tools may not be available depending on the printer you are using.)
 - operation panel of the printer
 - IJ Network Tool
 - printer information screen displayed on some Canon application software
 - IJ Network Device Setup Utility*
- * Only for Windows
- If the password has been changed while you are sharing the printer and you do not know the password, ask the administrator of the printer you are using.
- Set the password back to the default setting by initializing the printer settings.

For more on initializing the printer, search for "UG067" or "UG505" on your printer's Online Manual and see the instructions shown.

Password and Cookie

Password

Cookie

Password

Enter the password when the authentication screen is displayed.

Administrator Password

You need to enter the user name as well as the password depending on the printer you are using. For more on the user name, see the link above.

Important

- A message to warn you that the identification information is not verified may be displayed depending on the printer you are using.
- We recommend you change the password.

Cookie

Cookie allows a website master to save user information or user's access log on each computer through a web browser temporarily.

The printer may send one or more cookies to your communication device to verify **Remote UI** users and to enable the printer to offer useful information for each user.

Important

- Most browsers automatically accept cookies, but you can modify your browser setting so as not to accept cookies.
If you modify your browser so as not to accept cookies, you cannot log on to **Remote UI** and none of its functions are available.

Note

- Use an OS or web browser below to use **Remote UI**.
 - iOS devices:
OS: iOS 7.0 or later
Browser: Default browser of iOS device (Mobile Safari)
 - Android devices:
OS: Android 4.0 or later
Browser: Default browser of Android device (browser or Chrome)
 - Mac OS devices:
OS: Mac OS X v.10.6 or later
Browser: Safari 5.1 or later
 - Windows devices:

OS: Windows Vista SP2 or later

Browser: Internet Explorer 9 or later / Google Chrome 41.0.2272.118m or later / Mozilla Firefox 37.0.1 or later

How to locate your printer's serial number

The serial number is printed on a white sticker attached to each printer. The serial number will consists of 9 alphanumeric characters (4 letters followed by 5 numbers).

Example:

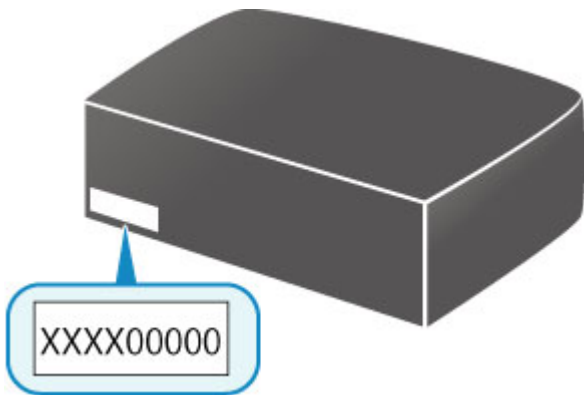

▶▶ Note

- Depending on the printer you are using, you can check the serial number by printing out the network setting information of the printer. For more on printing, search for "NR044" on your printer's Online Manual and see the instructions shown.

Registering Root Certificate to Web Browser

When you display **Remote UI** for the first time on your smartphone, tablet, or computer, download the root certificate, and then register it to the web browser. The secure connection will be confirmed and a message will not appear.

For details, search for "AF111" on your printer's Online Manual and see the instructions shown.

Printing

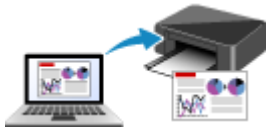

Printing from Computer



Printing from Smartphone/Tablet

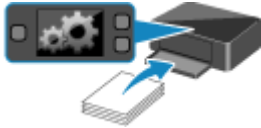

Paper Settings

Printing from Computer

- [Printing from Application Software \(Windows Printer Driver\)](#)
- [Printing from Application Software \(Mac OS Printer Driver\)](#)
- [Printing Using Canon Application Software](#)
- [Printing Using a Web Service](#)
- [Printing from an AirPrint-enabled Printer with Mac](#)

Printing from Application Software (Windows Printer Driver)

- **Printing with Easy Setup** 📌 **Basic**
- **Various Printing Methods**
- **Changing the Print Quality and Correcting Image Data**
- **Overview of the Printer Driver**
- **Printer Driver Description**
- **Updating the Printer Driver**

Printing with Easy Setup

This section describes the simple procedure for setting the [Quick Setup tab](#) so that you can carry out appropriate printing on this printer.

Printing with Easy Setup

1. [Check that the printer is turned on](#)
2. [Load paper](#) on the printer
3. Open the [printer driver setup window](#)
4. Select a frequently used profile

In **Commonly Used Settings** on the **Quick Setup** tab, select a printing profile suited for the purpose. When you select a printing profile, the **Additional Features**, **Media Type**, and **Printer Paper Size** settings are automatically switched to the values that were preset.

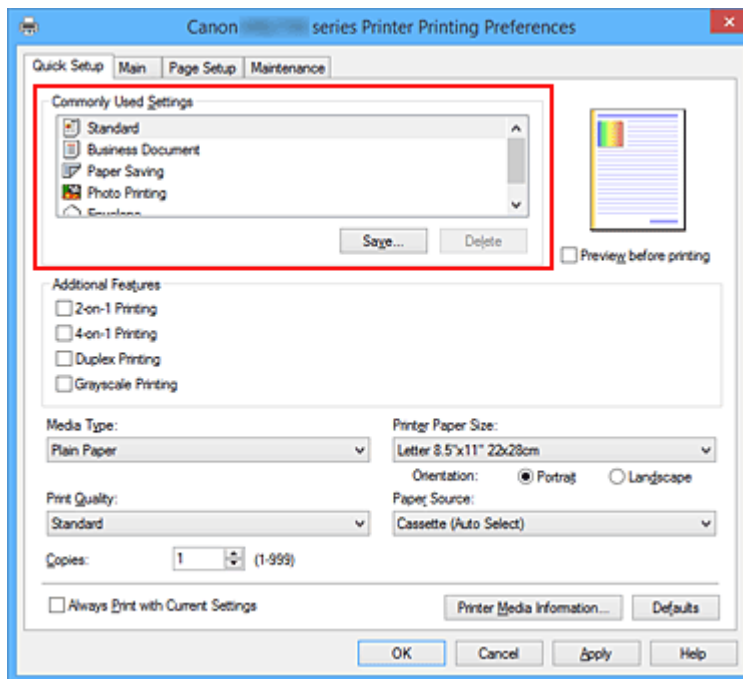

5. Select the print quality

For **Print Quality**, select **High** or **Standard** according to your purpose.

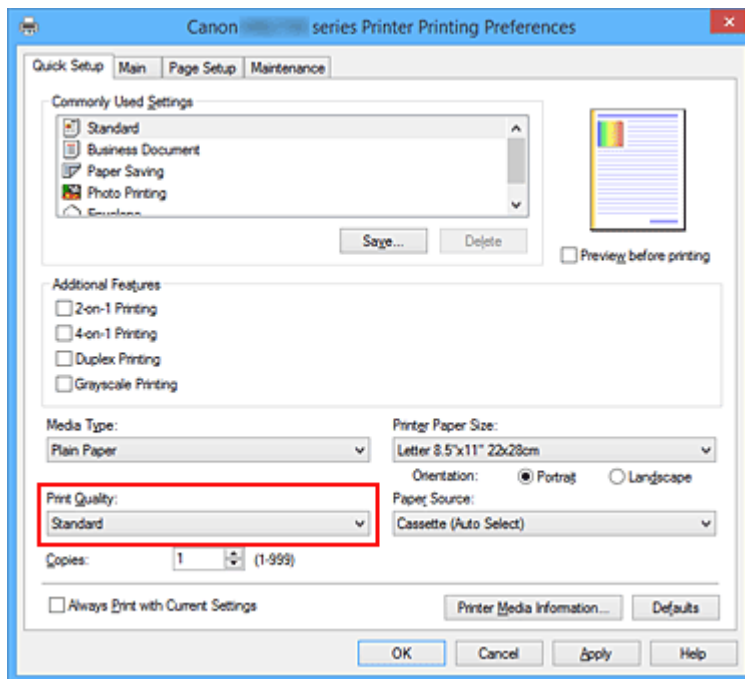

»»» Important

- The print quality settings that can be selected may differ depending on a printing profile.

6. Select the paper source

Select **Cassette (Auto Select)**, **Cassette 1**, or **Cassette 2** that matches your purpose for **Paper Source**.

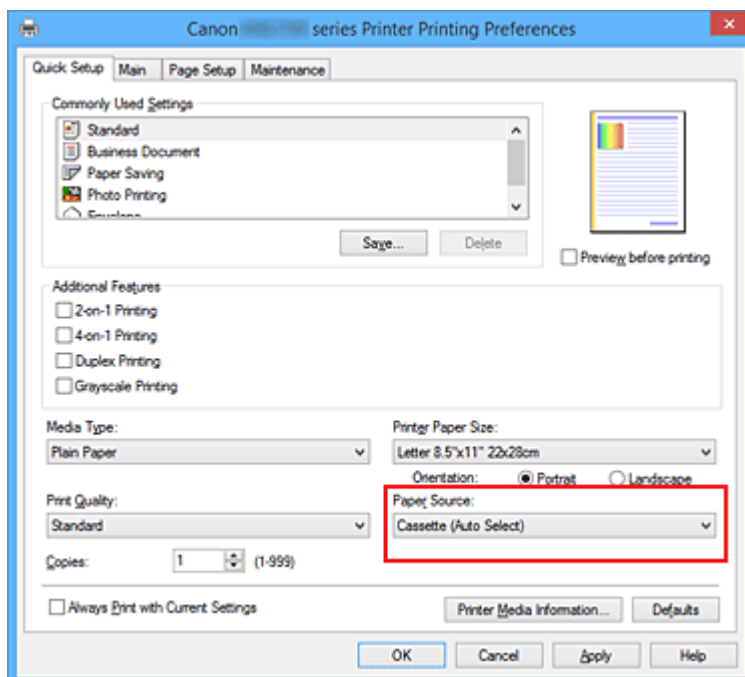

»»» Important

- The paper source settings that can be selected may differ depending on the paper type and size.

7. Complete the setup

Click **OK**.

When you execute print, the document is printed with settings that match your purpose.

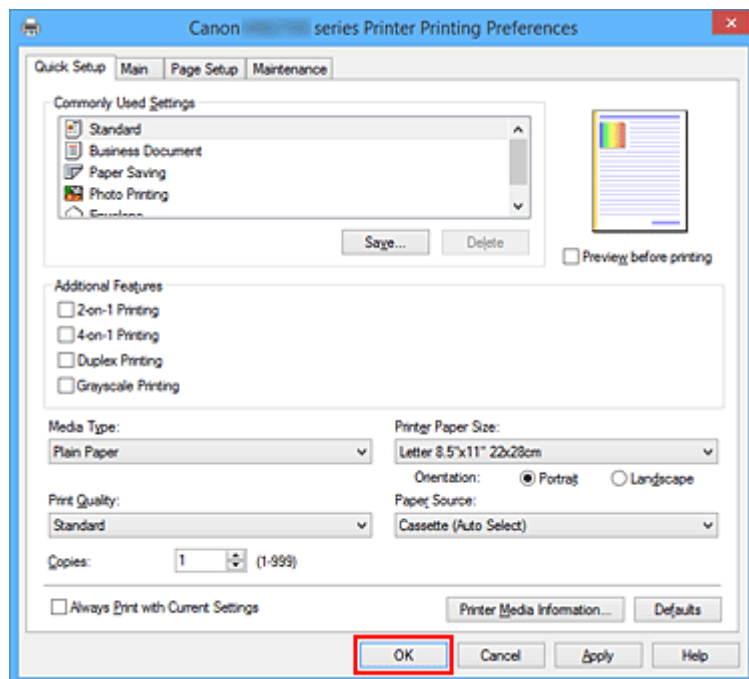

►► Important

- When you select the **Always Print with Current Settings** check box, all settings specified on the **Quick Setup**, **Main**, and **Page Setup** tabs are saved, and you can print with the same settings from the next time as well.
- In the **Commonly Used Settings** window, click **Save...** to [register the specified settings](#).

►► Note

- If the paper settings on the printer driver differ from the cassette paper information registered on the printer, an error may occur. For instructions on what to do if an error occurs, see "[Paper Settings](#)." To check the current printer settings or to apply the printer settings to the printer driver, click **Printer Media Information...** from the **Quick Setup** tab, and specify the settings in the dialog box that appears.
For details about the cassette paper information to be registered on the printer, see the following:
 - [Paper Settings on the Printer Driver and the Printer \(Media Type\)](#)
 - [Paper Settings on the Printer Driver and the Printer \(Paper Size\)](#)

Checking Printer Settings and Applying Settings to Printer Driver

1. Open printer driver setup window
2. Click **Printer Media Information...** on **Quick Setup** tab
The **Printer Media Information** dialog box appears.

3. Select **Paper Source**

From **Paper Source**, check the setting or select a new paper source.

The current printer settings appear in **Media Type** and **Page Size**.

4. Apply settings

To apply the printer settings to the printer driver, click **Set**.

Note

- If the media type on the printer is set to Hagaki, Ink Jet Hagaki, or Hagaki K or if the output paper size on the printer is set to 2L/5"x7"(13x18), click **Set** to display the dialog box. Select the media type and paper size that matches your purpose, and then click **OK**.
- If the media type and the output paper size are not set on the printer, **Set** will be grayed out and cannot be clicked.
- If communication with the printer is disabled, the **Printer Media Information...** does not appear or printer media information from the printer cannot be obtained.

Paper Settings on the Printer Driver and the Printer (Media Type)

When you use this printer, selecting a media type and [paper size](#) that matches the print purpose will help you achieve the best print results.

You can use the following media types on this printer.

Canon genuine papers (Document Printing)

Media name <Model No.>	Media Type in the printer driver	Paper information registered on the printer
Canon Red Label Superior <WOP111>	Plain Paper	Plain paper
Canon Océ Office Colour Paper <SAT213>	Plain Paper	Plain paper

Canon genuine papers (Photo Printing)

Media name <Model No.>	Media Type in the printer driver	Paper information registered on the printer
Photo Paper Plus Glossy II <PP-201>	Photo Paper Plus Glossy II	PlusGlossyII
Photo Paper Pro Luster <LU-101>	Photo Paper Pro Luster	Pro Luster
Photo Paper Plus Semi-gloss <SG-201>	Photo Paper Plus Semi-gloss	Semi-gloss
Photo Paper Glossy <GP-501/GP-601>	Glossy Photo Paper	Glossy
Matte Photo Paper <MP-101>	Matte Photo Paper	Matte

Canon genuine papers (Business Letter Printing)

Media name <Model No.>	Media Type in the printer driver	Paper information registered on the printer
High Resolution Paper <HR-101N>	High Resolution Paper	High Res

Commercially available papers

Media name	Media Type in the printer driver	Paper information registered on the printer
Plain Paper (including recycled paper)	Plain Paper	Plain paper
Envelopes	Envelope	Envelope
Label Paper	Label Paper	Label Paper

Paper Settings on the Printer Driver and the Printer (Paper Size)

When you use this printer, selecting a paper size that matches the print purpose will help you achieve the best print results.

You can use the following paper sizes on this printer.

Printer Paper Size in the printer driver	Paper information registered on the printer
Letter 8.5"x11" 22x28cm	Letter
Legal 8.5"x14" 22x36cm	Legal
Executive 7.25"x10.5" 184.2x266.7mm	Exec.
A6	A6
A5	A5
A4	A4
B5	B5
Oficio 8.5"x12.5" 215.9x317.5mm	Oficio
B-Oficio 8.5"x14" 216.0x355.0mm	B-Ofi.
M-Oficio 8.50"x13.43" 216.0x341.0mm	M-Ofi.
Foolscap 8.5"x13" 215.9x330.2mm	Fcap
Legal (India) 8.46"x13.58" 215x345mm	LGL In
4"x6" 10x15cm	KG/4"x6"
5"x7" 13x18cm	2L/5"x7"
8"x10" 20x25cm	8"x10"
L 89x127mm	L
2L 127x178mm	2L/5"x7"
Envelope Com 10	Env. Com 10
Envelope DL	Envelope DL
Yougata 4 4.13"x9.25"	Yougata 4
Yougata 6 3.86"x7.48"	Yougata 6
Envelope C5	Envelope C5
Envelope Monarch 3.88"x7.5" 98.4x190.5mm	Env Monarch
Custom Size	Others

Various Printing Methods

- ▶ **Setting a Page Size and Orientation**
- ▶ **Setting the Number of Copies and Printing Order**
- ▶ **Setting the Stapling Margin**
- ▶ **Fit-to-Page Printing**
- ▶ **Scaled Printing**
- ▶ **Page Layout Printing**
- ▶ **Tiling/Poster Printing**
- ▶ **Booklet Printing**
- ▶ **Duplex Printing**
- ▶ **Stamp/Background Printing**
- ▶ **Registering a Stamp**
- ▶ **Registering Image Data to be Used as a Background**
- ▶ **Setting Up Envelope Printing**
- ▶ **Printing on Postcards**
- ▶ **Switching the Paper Source to Match the Purpose**
- ▶ **Displaying the Print Results before Printing**
- ▶ **Setting Paper Dimensions (Custom Size)**
- ▶ **Editing the Print Document or Reprinting from the Print History**

Setting a Page Size and Orientation

The paper size and orientation are essentially determined by the application software. When the page size and orientation set for **Page Size** and **Orientation** on the **Page Setup** tab are same as those set with the application software, you do not need to select them on the **Page Setup** tab.

When you are not able to specify them with the application software, the procedure for selecting a page size and orientation is as follows:

You can also set page size and orientation on the **Quick Setup** tab.

1. Open the [printer driver setup window](#)

2. Select the paper size

Select a page size from the **Page Size** list on the **Page Setup** tab.

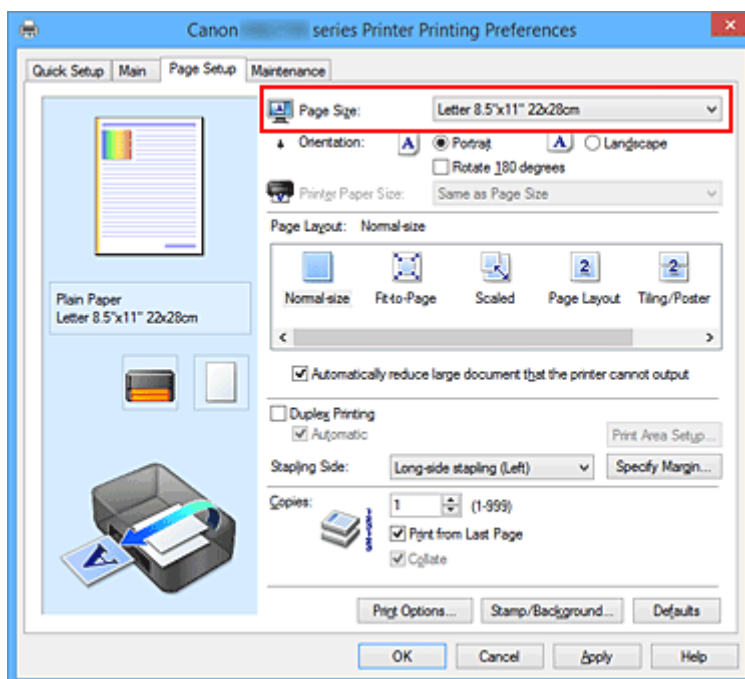

3. Set **Orientation**

Select **Portrait** or **Landscape** for **Orientation**. Check **Rotate 180 degrees** check box when you want to perform printing with the original being rotated 180 degrees.

4. Complete the setup

Click **OK**.

When you execute print, the document will be printed with the selected page size and the orientation.

►►► Note

- If **Normal-size** is selected for **Page Layout**, then **Automatically reduce large document that the printer cannot output** is displayed.

Normally, you can leave the check box checked. During printing, if you do not want to reduce large documents that cannot be printed on the printer, uncheck the check box.

Setting the Number of Copies and Printing Order

The procedure for specifying the number of copies and printing order is as follows:
You can also set the number of copies on the **Quick Setup** tab.

1. Open the [printer driver setup window](#)
2. Specify the number of copies to be printed

For **Copies** on the **Page Setup** tab, specify the number of copies to be printed.

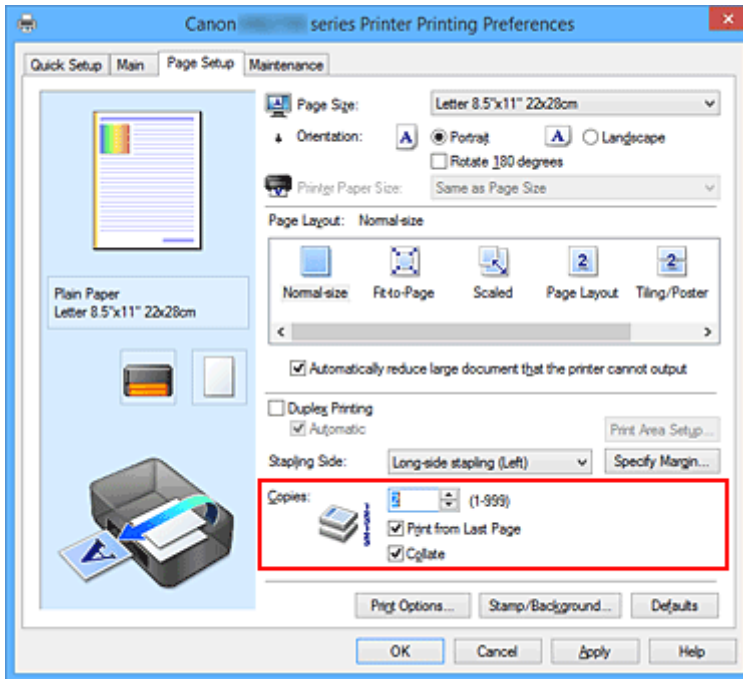

3. Specify the print order

Check the **Print from Last Page** check box when you want to print from the last page in order, and uncheck the check box when you want to print from the first page.

Check the **Collate** check box when you are printing multiple copies of a document and want to print out all pages in each copy together. Uncheck this check box when you want to print all pages with the same page number together.

- **Print from Last Page:** / **Collate:**

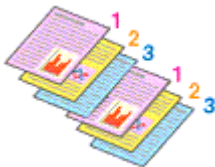

- **Print from Last Page:** / **Collate:**

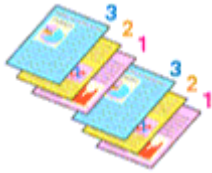

- **Print from Last Page:** / **Collate:**

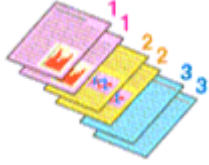

- **Print from Last Page:** / **Collate:**



4. Complete the setup

Click **OK**.

When you execute print, the specified number of copies will be printed with the specified printing order.

»» Important

- When the application software that you used to create the document has the same function, specify the settings on the printer driver. However, if the print results are not acceptable, specify the function settings on the application software. When you specify the number of copies and the printing order with both the application software and this printer driver, the number of copies may be multiplied numbers of the two settings or the specified printing order may not be enabled.
- **Print from Last Page** appears grayed out and is unavailable when **Tiling/Poster** is selected for **Page Layout**.
- When **Booklet** is selected for **Page Layout**, **Print from Last Page** and **Collate** appear grayed out and cannot be set.
- When **Duplex Printing** is selected, **Print from Last Page** appears grayed out and cannot be set.

»» Note

- By setting both **Print from Last Page** and **Collate**, you can perform printing so that papers are collated one by one starting from the last page.
These settings can be used in combination with **Normal-size**, **Fit-to-Page**, **Scaled**, and **Page Layout**.

Setting the Stapling Margin



The procedure for setting the staple side and the margin width is as follows:

1. Open the [printer driver setup window](#)
2. Specify the side to be stapled

Check the position of the stapling margin from **Stapling Side** on the **Page Setup** tab.

The printer analyzes the **Orientation** and **Page Layout** settings, and automatically selects the best staple position. When you want to change the setting, select from the list.

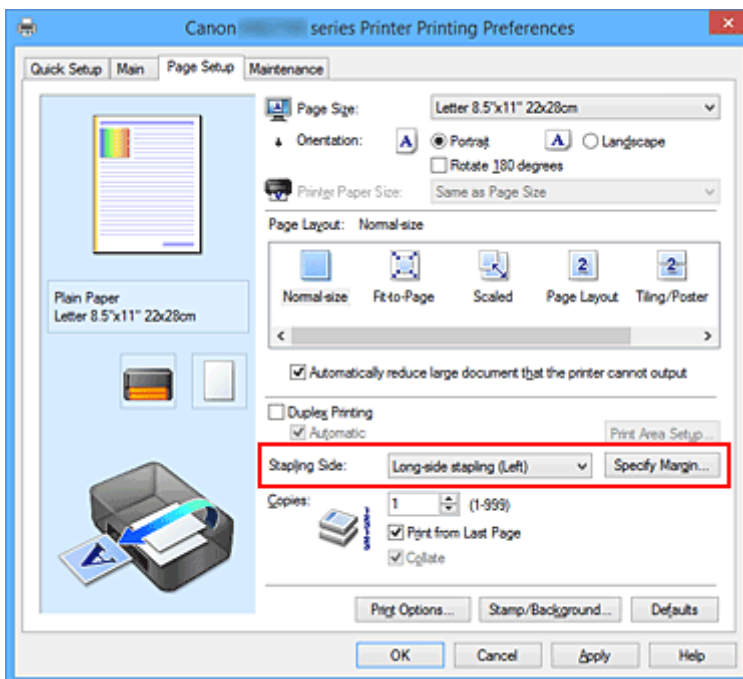

3. Set the margin width

If necessary, click **Specify Margin...** and set the margin width, and then click **OK**.

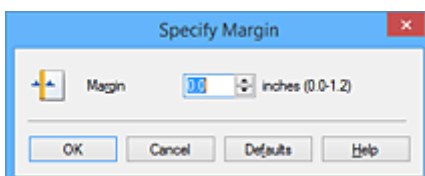

▶▶▶ Note

- The printer automatically reduces the print area depending on the staple position margin.

4. Complete the setup

Click **OK** on the **Page Setup** tab.

When you execute print, the data is printed with the specified staple side and margin width.

▶▶▶ Important

- **Stapling Side** and **Specify Margin...** appear grayed out and are unavailable when:
 - **Tiling/Poster** or **Booklet** is selected for **Page Layout**
 - **Scaled** is selected for **Page Layout** (When **Duplex Printing** is also selected, only **Stapling Side** can be specified.)

Fit-to-Page Printing



The procedure for printing a document that is automatically enlarged or reduced to fit the page size to be used is as follows:

1. Open the [printer driver setup window](#)

2. Set fit-to-page printing

Select **Fit-to-Page** from the **Page Layout** list on the **Page Setup** tab.

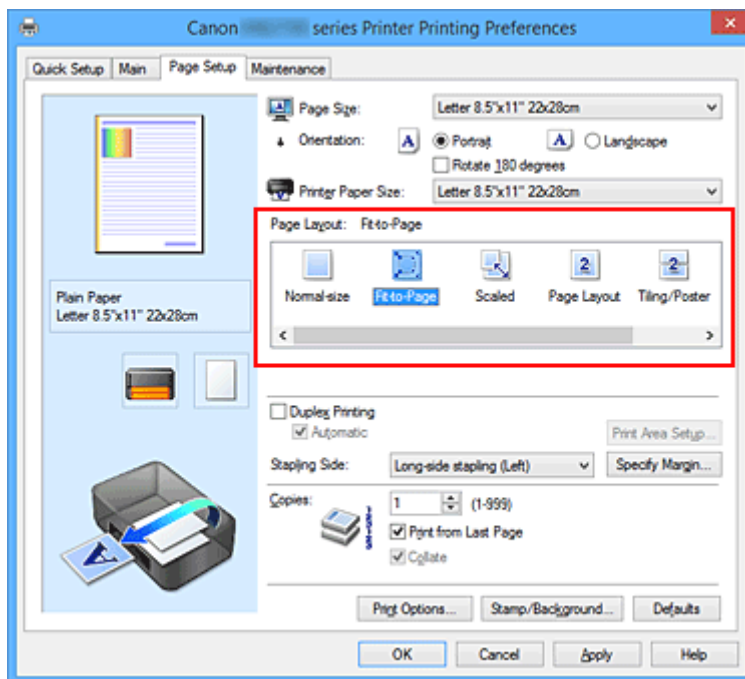

3. Select the paper size of the document

Using **Page Size**, select the page size that is set with your application software.

4. Select the print paper size

Select the size of the paper loaded in the printer from the **Printer Paper Size** list.

When the **Printer Paper Size** is smaller than the **Page Size**, the page image will be reduced. When the **Printer Paper Size** is larger than the **Page Size**, the page image will be enlarged.

The current settings are displayed in the settings preview on the left side of the printer driver.

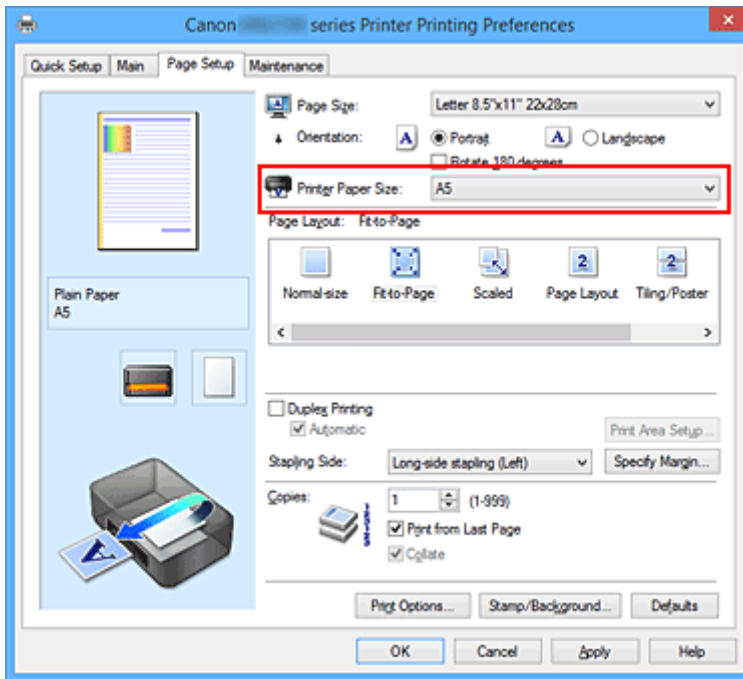

5. Complete the setup

Click **OK**.

When you execute print, the document will be enlarged or reduced to fit to the page size.

Scaled Printing



The procedure for printing a document with pages enlarged or reduced is as follows:

1. Open the [printer driver setup window](#)
2. Set scaled printing

Select **Scaled** from the **Page Layout** list on the **Page Setup** tab.

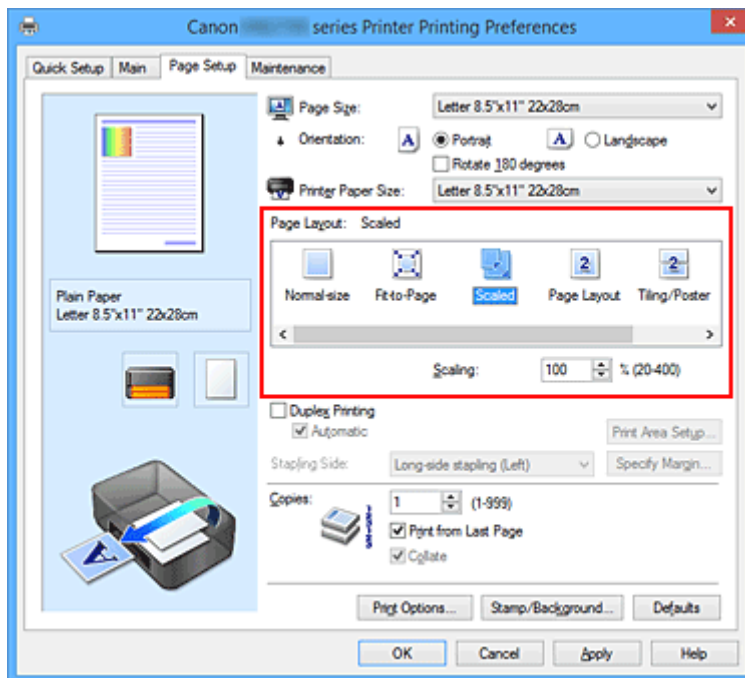

3. Select the paper size of the document

Using **Page Size**, select the page size that is set with your application software.

4. Set the scaling rate by using one of the following methods:

- Select a **Printer Paper Size**

When the printer paper size is smaller than the **Page Size**, the page image will be reduced. When the printer paper size is larger than the **Page Size**, the page image will be enlarged.

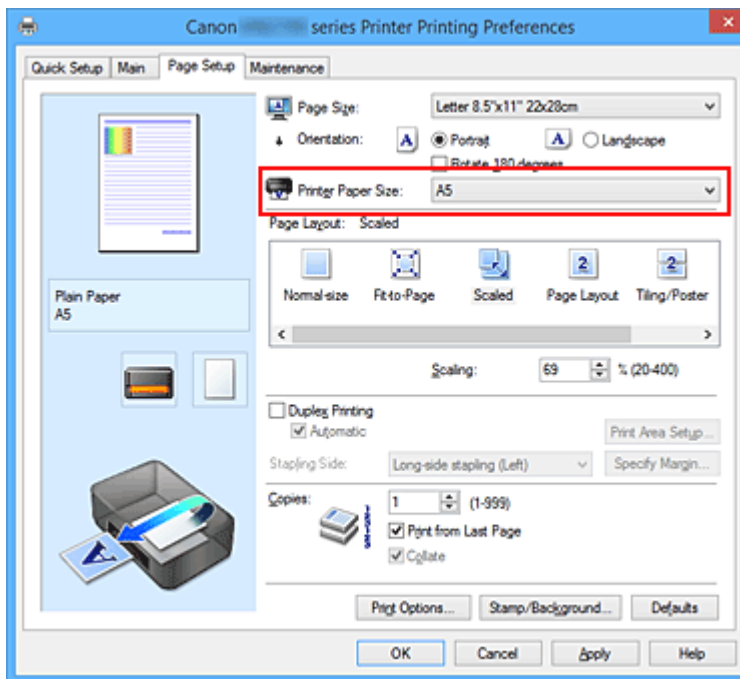

- Specify a scaling factor

Directly type in a value into the **Scaling** box.

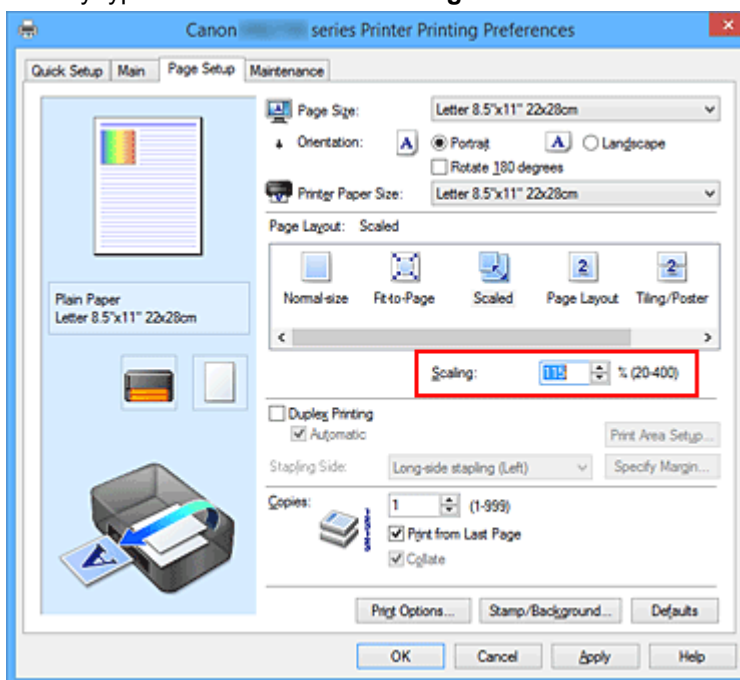

The current settings are displayed in the settings preview on the left side of the printer driver.

5. Complete the setup

Click **OK**.

When you execute print, the document will be printed with the specified scale.

»» Important

- When the application software which you used to create the original has the scaled printing function, configure the settings on your application software. You do not need to configure the same setting in the printer driver.

»» Note

- Selecting **Scaled** changes the printable area of the document.

Page Layout Printing

The page layout printing function allows you to print more than one page image on a single sheet of paper.



The procedure for performing page layout printing is as follows:

1. Open the [printer driver setup window](#)
2. Set page layout printing

Select **Page Layout** from the **Page Layout** list on the **Page Setup** tab.

The current settings are displayed in the settings preview on the left side of the printer driver.

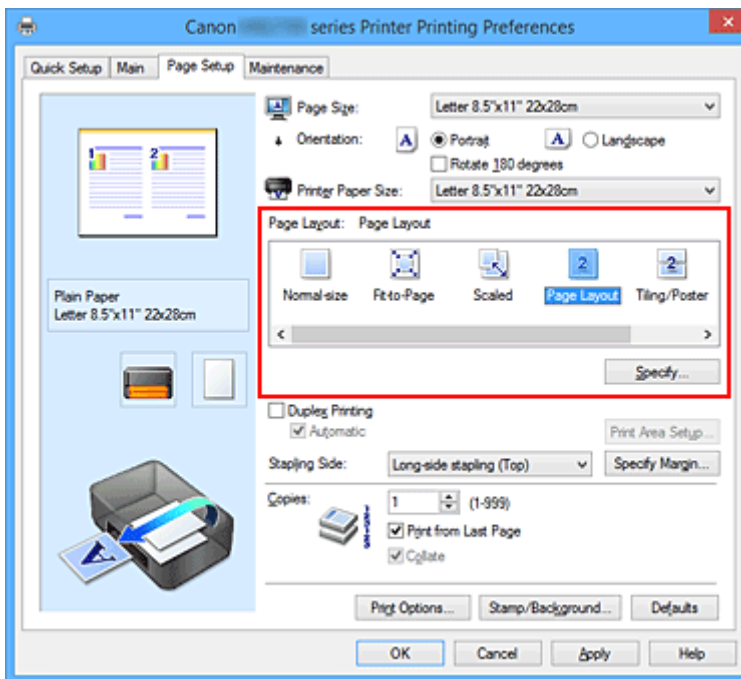

3. Select the print paper size

Select the size of the paper loaded in the printer from the **Printer Paper Size** list.

4. Set the number of pages to be printed on one sheet and the page order

If necessary, click **Specify...**, specify the following settings in the **Page Layout Printing** dialog box, and click **OK**.

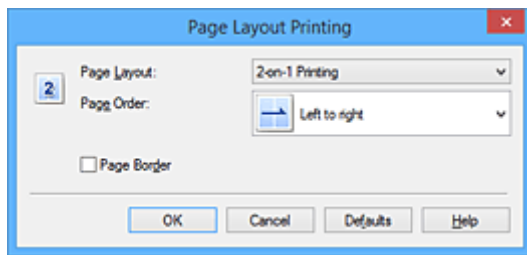

Page Layout

To change the number of pages to be printed on a single sheet of paper, select the number of pages from the list.

Page Order

To change the page arrangement order, select a placement method from the list.

Page Border

To print a page border around each document page, check this check box.

5. Complete the setup

Click **OK** on the **Page Setup** tab.

When you execute print, the specified number of pages will be arranged on each sheet of paper in the specified order.

Tiling/Poster Printing

The tiling/poster printing function allows you to enlarge image data, divide it into several pages, and print these pages on separate sheets of paper. You can also paste the pages together to create a large print like a poster.

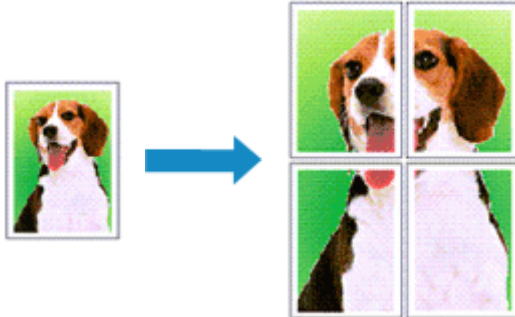

The procedure for performing tiling/poster printing is as follows:

Setting Tiling/Poster Printing

1. Open the [printer driver setup window](#)
2. Set tiling/poster printing

Select **Tiling/Poster** from the **Page Layout** list on the **Page Setup** tab.

The current settings are displayed in the settings preview on the left side of the printer driver.

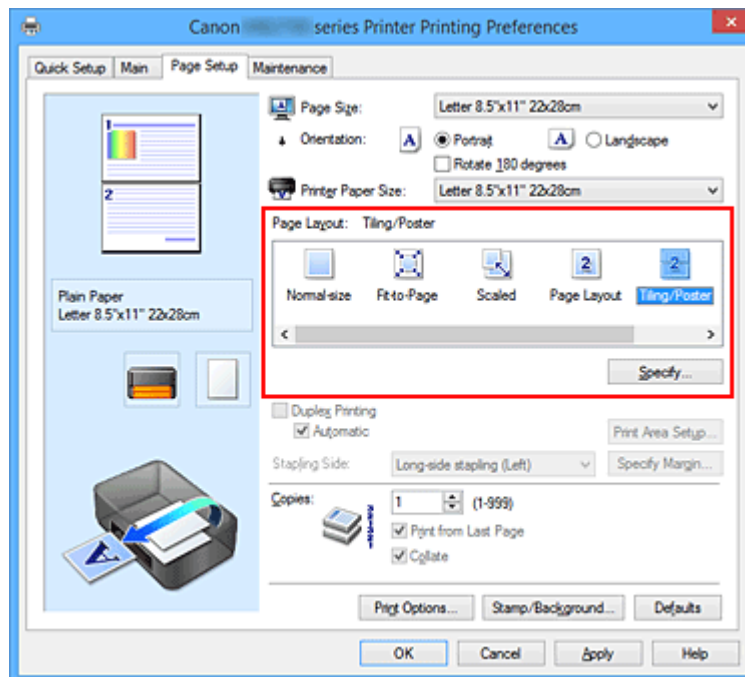

3. Select the print paper size

Select the size of the paper loaded in the printer from the **Printer Paper Size** list.

4. Set the number of image divisions and the pages to be printed

If necessary, click **Specify...**, specify the following settings in the **Tiling/Poster Printing** dialog box, and then click **OK**.

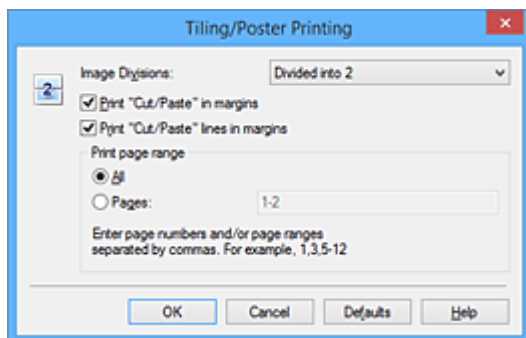

Image Divisions

Select the number of divisions (vertical x horizontal).

As the number of divisions increases, the number of sheets used for printing increases. If you are pasting pages together to create a poster, increasing the number of divisions allows you to create a larger poster.

Print "Cut/Paste" in margins

To leave out words "Cut" and "Paste", uncheck this check box.

»»» Note

- This feature may be unavailable when certain printer drivers or operating environments are used.

Print "Cut/Paste" lines in margins

To leave out cut lines, uncheck this check box.

Print page range

Specifies the printing range. Select **All** under normal circumstances.

To reprint only a specific page, select **Pages** and enter the page number you want to print. To specify multiple pages, enter the page numbers by separating them with commas or by entering a hyphen between the page numbers.

»»» Note

- You can also specify the print range by clicking the pages in the settings preview.

5. Complete the setup

Click **OK** on the **Page Setup** tab.

When you execute print, the document will be divided into several pages during printing.

Printing Only Specific Pages

If ink becomes faint or runs out during printing, you can reprint only the specific pages by following the procedure below:

1. Set the print range

In the settings preview on the left of the **Page Setup** tab, click the pages that do not need to be printed.

The pages that were clicked are deleted, and only the pages to be printed are displayed.

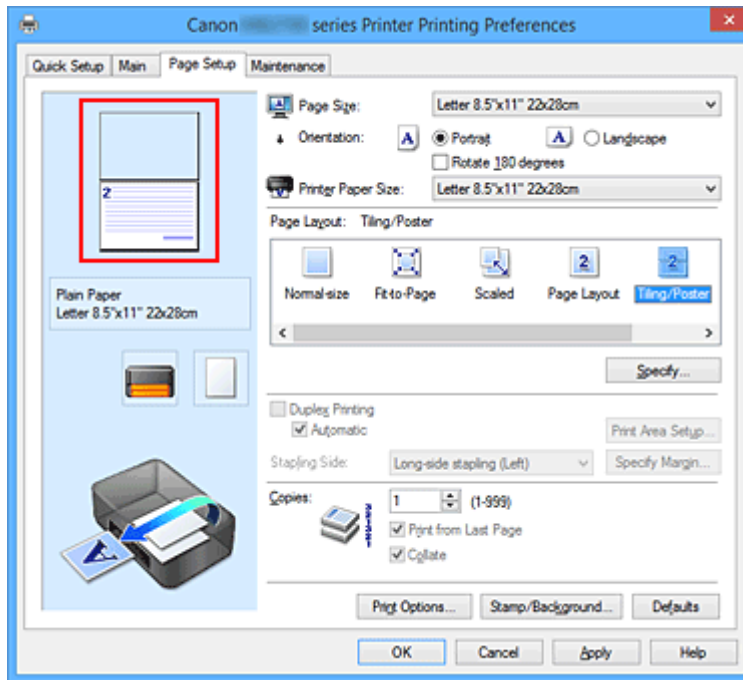

➤➤➤ Note

- Click the deleted pages to display them again.
- Right-click the settings preview to select **Print all pages** or **Delete all pages**.

2. Complete the setup

After completing the page selection, click **OK**.

When you execute print, only specified pages will be printed.

➤➤➤ Important

- Since tiling/poster printing enlarges the document when printing it, the print results may become coarse.

Booklet Printing

The booklet printing function allows you to print data for a booklet. Data is printed on both sides of the paper. This type of printing ensures that pages can be collated properly, in page number order, when the printed sheets are folded and stapled at the center.

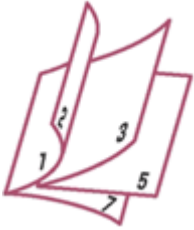

The procedure for performing booklet printing is as follows:

1. Open the [printer driver setup window](#)
2. Set booklet printing

Select **Booklet** from the **Page Layout** list on the **Page Setup** tab.

The current settings are displayed in the settings preview on the left side of the window.

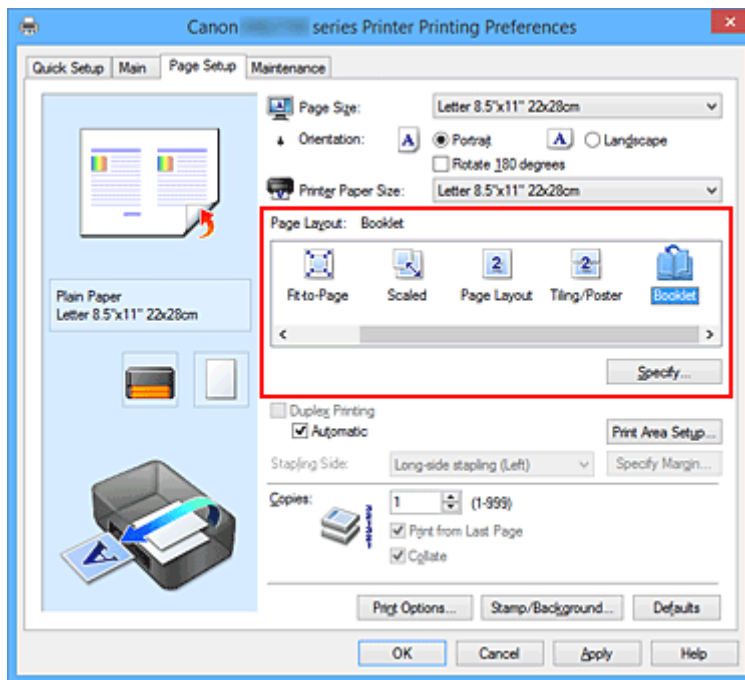

3. Select the print paper size

Select the size of the paper loaded in the printer from the **Printer Paper Size** list.

4. Set the margin for stapling and the margin width

Click **Specify...** and specify the following settings in the **Booklet Printing** dialog box, and then click **OK**.

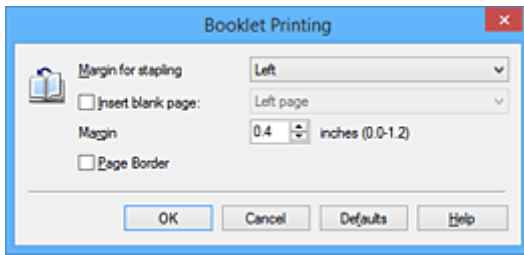

Margin for stapling

Select which side should the stapling margin be on when the booklet is completed.

Insert blank page

To leave one side of a sheet blank, check the check box, and select the page to be left blank.

Margin

Enter the margin width. The specified width from the center of the sheet becomes the margin width for one page.

Page Border

To print a page border around each document page, check the check box.

5. Complete the setup

Click **OK** on the **Page Setup** tab.

When you execute print, the document is automatically printed first on one side of a sheet of paper and then on the opposite side.

When the printing is complete, fold the paper at the center of the margin and make a booklet.

»» Important

- **Booklet** cannot be selected when a media type other than **Plain Paper** is selected for **Media Type** on the **Main** tab.

»» Note

- The stamp and background are not printed on the inserted blank sheets with the **Insert blank page** function of booklet printing.

Duplex Printing

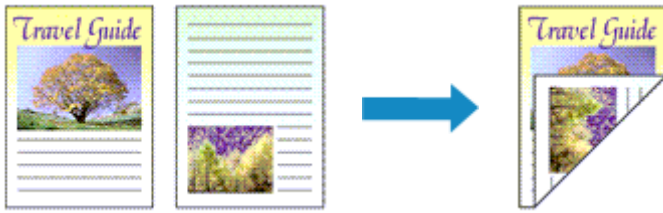

The procedure for printing data on both sides of a sheet of paper is as follows:
You can also set duplex printing in **Additional Features** on the **Quick Setup** tab.

Performing Automatic Duplex Printing

You can perform the duplex printing without having to turn over the paper.

1. Open the [printer driver setup window](#)
2. Set automatic duplex printing

Check the **Duplex Printing** check box on the **Page Setup** tab and confirm that **Automatic** is checked.

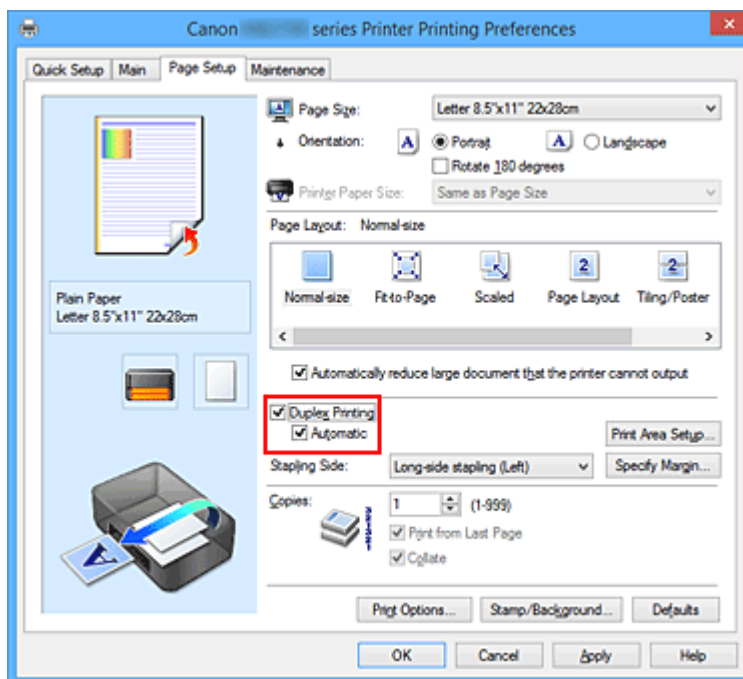

3. Select the layout
Select **Normal-size**, **Fit-to-Page**, **Scaled**, or **Page Layout** from the **Page Layout** list.
4. Set the print area

When you perform duplex printing, the print area of the document becomes slightly narrower than usual and the document may not fit on one page.

Click **Print Area Setup...**, select one of the following process methods, and then click **OK**.

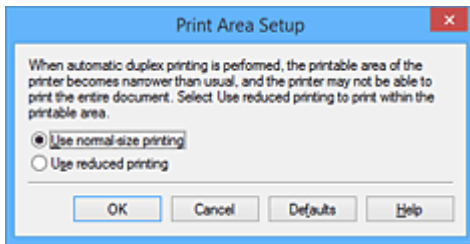

Use normal-size printing

Print without reducing the page.

Use reduced printing

Reduce the page slightly during printing.

5. Specify the side to be stapled

The best **Stapling Side** is selected automatically from the **Orientation** and **Page Layout** settings. To change the setting, select another stapling side from the list.

6. Set the margin width

If necessary, click **Specify Margin...** and set the margin width, and then click **OK**.

7. Complete the setup

Click **OK** on the **Page Setup** tab.

When you execute print, duplex printing will be started.

Performing Duplex Printing Manually

You can perform the duplex printing manually.

1. Open the [printer driver setup window](#)

2. Set duplex printing

Check the **Duplex Printing** check box and uncheck the **Automatic** check box on the **Page Setup** tab.

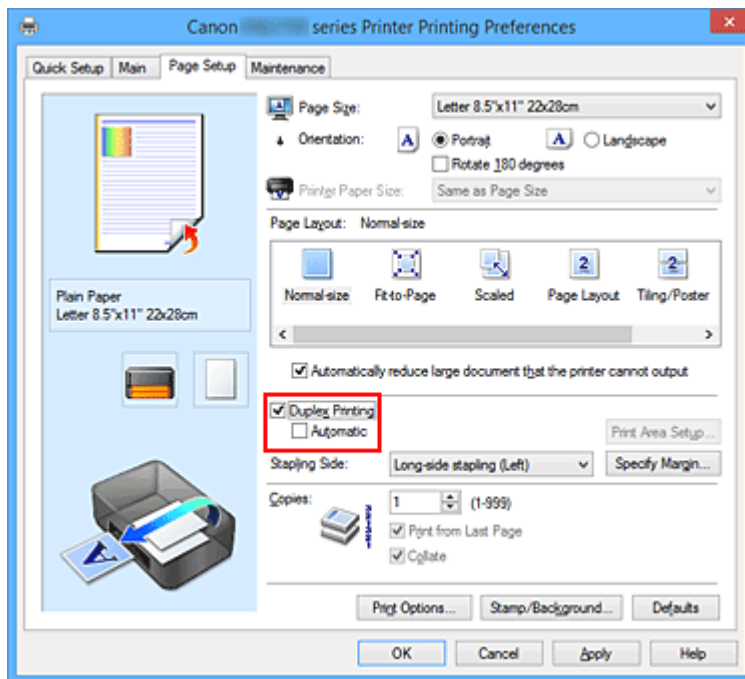

3. Select the layout

Select **Normal-size**, **Fit-to-Page**, **Scaled**, or **Page Layout** from the **Page Layout** list.

4. Specify the side to be stapled

The best **Stapling Side** is selected automatically from the **Orientation** and **Page Layout** settings. To change the setting, select another stapling side from the list.

5. Set the margin width

If necessary, click **Specify Margin...** and set the margin width, and then click **OK**.

6. Complete the setup

Click **OK** on the **Page Setup** tab.

When you execute print, the document is first printed on one side of a sheet of paper. After one side is printed, reload the paper correctly according to the message.

Then click **Start Printing** to print the opposite side.

►►► Important

- When a media type other than **Plain Paper** is selected from the **Media Type** list on the **Main** tab, **Duplex Printing** appears grayed out and is unavailable.
- When **Tiling/Poster**, or **Booklet** is selected from the **Page Layout** list, **Duplex Printing** and **Stapling Side** appear grayed out and are unavailable.
- **Duplex Printing** can be performed only when one of the following paper sizes is selected from **Page Size** on the **Page Setup** tab.
 - **Letter 8.5"x11" 22x28cm, A4**

- After printing the front page, there is an ink drying wait time before starting to print the back page (Operation stops temporarily). Do not touch the paper during this time. You can change the ink drying wait time at **Custom Settings** on the **Maintenance** tab.

Related Topic

- [Changing the Printer Operation Mode](#)

Stamp/Background Printing

Stamp or **Background** may be unavailable when certain printer drivers or operating environments are used.

The **Stamp** function allows you to print a stamp text or a bitmap over or behind document data. It also allows you to print date, time and user name. The **Background** function allows you to print a light illustration behind the document data.

The procedure for performing stamp/background printing is as follows:

Printing a Stamp

"CONFIDENTIAL," "IMPORTANT," and other stamps that are used often in companies are pre-registered.

1. Open the [printer driver setup window](#)
2. Click **Stamp/Background... (Stamp...)** on the **Page Setup** tab

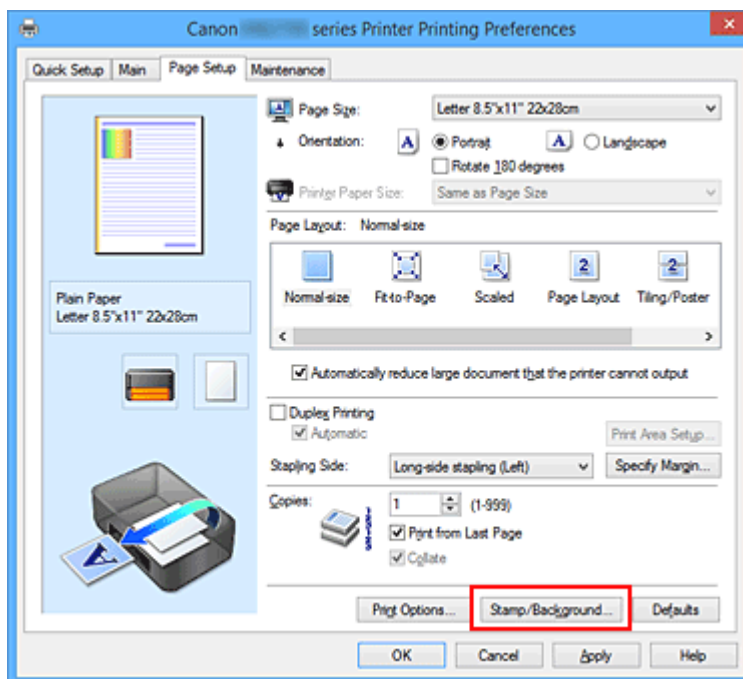

The **Stamp/Background (Stamp)** dialog box opens.

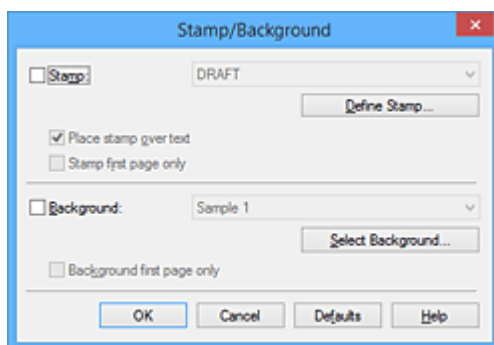

»» Note

- With the XPS printer driver, the **Stamp/Background...** button has become the **Stamp...** button and only the stamp function can be used.

3. Select a stamp

Check the **Stamp** check box, and select the stamp to be used from the list.

The current settings are displayed in the settings preview on the left side of the **Page Setup** tab.

4. Set the stamp details

If necessary, specify the following settings, and then click **OK**.

Define Stamp... button

To [change the stamp text, bitmap, or position](#), click this.

Place stamp over text

To print the stamp on the front of the document, check this check box.

»» Note

- The stamp is given priority because the stamp is printed over the document data in the sections where the stamp and the document data overlap. When this check box is unchecked, the stamp is printed behind the document data and may be hidden in the overlapping sections depending on the application software used.
- **Place stamp over text** cannot be used when the XPS printer driver is used. When the XPS printer driver is used, the stamp is normally printed in the foreground of the document.

Print semitransparent stamp

Check this check box to print a semi-transparent stamp on the document.

This function is available only when the XPS printer driver is used.

Stamp first page only

To print the stamp only on the first page, check this check box.

5. Complete the setup

Click **OK** on the **Page Setup** tab.

When you execute print, the data is printed with the specified stamp.

Printing a Background

Two bitmap files are pre-registered as samples.

1. Open the [printer driver setup window](#)
2. Click **Stamp/Background...** on the **Page Setup** tab
The **Stamp/Background** dialog box opens.
3. Select the background

Check the **Background** check box, and select the background to be used from the list.
The current settings are displayed in the settings preview on the left side of the **Page Setup** tab.

4. Set the background details

If necessary, complete the following settings, and then click **OK**.

Select Background... button

To [use another background or change the layout or density of a background](#), click this.

Background first page only

To print the background only on the first page, check this check box.

5. Complete the setup

Click **OK** on the **Page Setup** tab.

When you execute print, the data is printed with the specified background.

»» Note

- The stamp and background are not printed on blank sheets inserted with the **Insert blank page** function of booklet printing.

Related Topics

- [Registering a Stamp](#)
- [Registering Image Data to be Used as a Background](#)

Registering a Stamp

This feature may be unavailable when certain printer drivers or operating environments are used.

You can create and register a new stamp. You can also change and re-register some of the settings of an existing stamp. Unnecessary stamps can be deleted at any time.

The procedure for registering a new stamp is as follows:

Registering a New Stamp

1. Open the [printer driver setup window](#)
2. Click **Stamp/Background... (Stamp...)** on the **Page Setup** tab

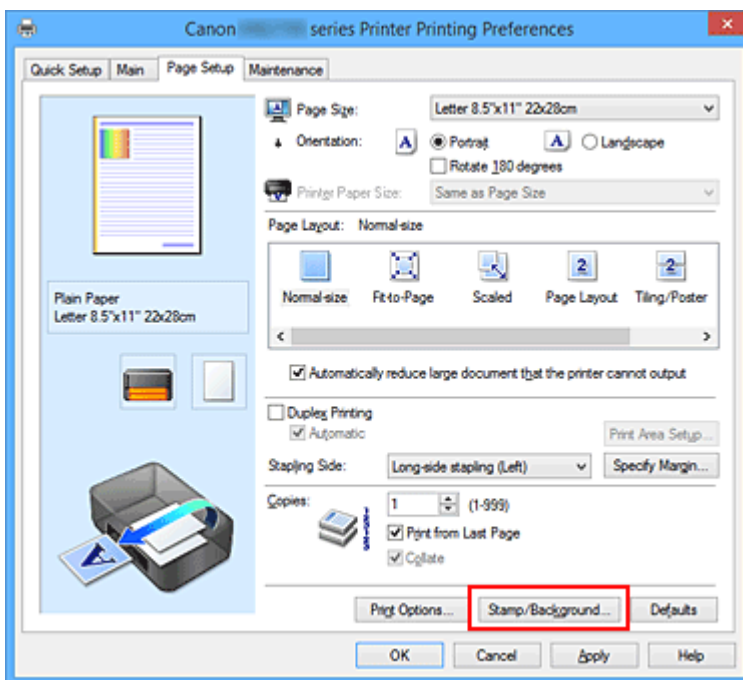

The **Stamp/Background (Stamp)** dialog box opens.

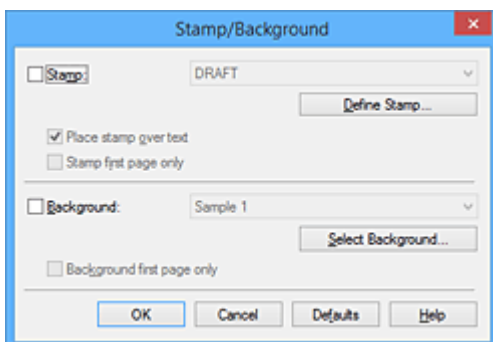

➤➤➤ Note

- With the XPS printer driver, the **Stamp/Background...** button has become the **Stamp...** button and only the stamp function can be used.

3. Click **Define Stamp...**

The **Stamp Settings** dialog box opens.

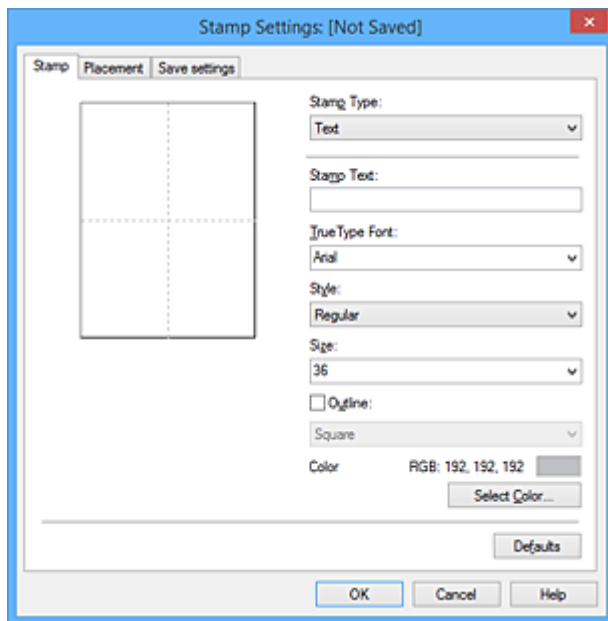

4. Configure the stamp while viewing the preview window

- **Stamp tab**

Select **Text**, **Bitmap**, or **Date/Time/User Name** that matches your purpose for **Stamp Type**.

- For **Text** registration, the characters must already be entered in **Stamp Text**. If necessary, change the **TrueType Font**, **Style**, **Size**, and **Outline** settings. You can select the color of the stamp by clicking **Select Color...**
- For **Bitmap**, click **Select File...** and select the bitmap file (.bmp) to be used. If necessary, change the settings of the **Size** and **Transparent white area**.
- For **Date/Time/User Name**, the creation date/time and user name of the printed object are displayed in **Stamp Text**. If necessary, change the settings of **TrueType Font**, **Style**, **Size**, and **Outline**. You can select the color of the stamp by clicking **Select Color...**

»»» Important

- **Stamp Text** appears grayed out and is unavailable when **Date/Time/User Name** is selected.

- **Placement tab**

Select the stamp position from the **Position** list. You can also select **Custom** from the **Position** list and specify coordinates for **X-Position** and **Y-Position**.

You can also change the stamp position by dragging the stamp in the preview window.

To change the stamp position angle, type a value in the **Orientation** box directly.

»»» Important

- **Orientation** cannot be changed when **Bitmap** is selected for **Stamp Type** on the **Stamp** tab.

5. Save the stamp

Click the **Save settings** tab and enter a title in the **Title** box, and then click **Save**.
Click **OK** when the confirmation message appears.

»» Note

- Spaces, tabs, and returns cannot be entered at the beginning or end of a title.

6. Complete the setup

Click **OK**. The **Stamp/Background (Stamp)** dialog box opens again.
The registered title appears in the **Stamp** list.

Changing and Registering Some of Stamp Settings

1. Select the stamp for which the settings are to be changed

Select the **Stamp** check box in the **Stamp/Background (Stamp)** dialog box. Then from the list, select the title of the stamp to be changed.

2. Click **Define Stamp...**

The **Stamp Settings** dialog box opens.

3. Configure the stamp while viewing the preview window

4. Overwrite save the stamp

Click **Save overwrite** on the **Save settings** tab.

When you want to save the stamp with a different title, type a new title in the **Title** box and click **Save**.
Click **OK** when the confirmation message appears.

5. Complete the setup

Click **OK**. The **Stamp/Background (Stamp)** dialog box opens again.
The registered title appears in the **Stamp** list.

Deleting an Unnecessary Stamp

1. Click **Define Stamp...** in the **Stamp/Background (Stamp)** dialog box

The **Stamp Settings** dialog box opens.

2. Select the stamp to be deleted

Select the title of the stamp you want to delete from the **Stamps** list on the **Save settings** tab. Then click **Delete**.

Click **OK** when the confirmation message appears.

3. Complete the setup

Click **OK**. The **Stamp/Background (Stamp)** dialog box opens again.

Registering Image Data to be Used as a Background

This feature may be unavailable when certain printer drivers or operating environments are used.

You can select a bitmap file (.bmp) and register it as a new background. You can also change and register some of the settings of an existing background. An unnecessary background can be deleted.

The procedure for registering image data to be used as a background is as follows:

Registering New Background

1. Open the [printer driver setup window](#)
2. Click **Stamp/Background...** on the **Page Setup** tab

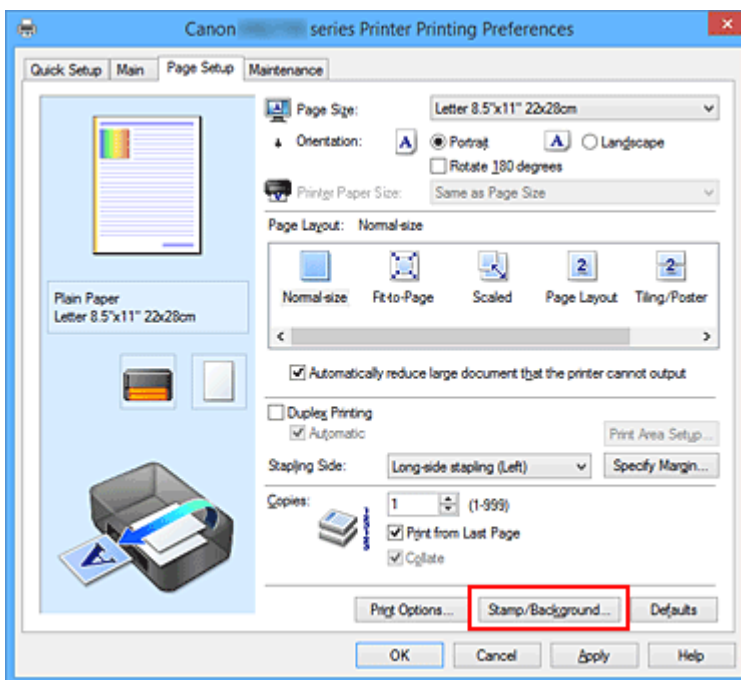

The **Stamp/Background** dialog box opens.

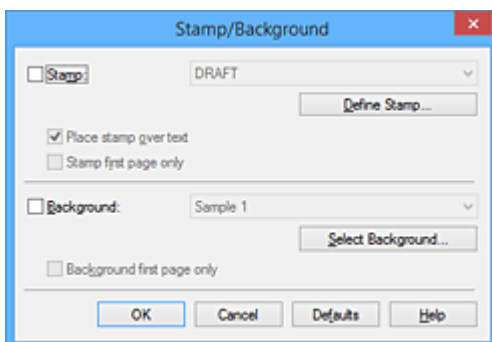

➤➤➤ Note

- With the XPS printer driver, the **Stamp/Background...** button has become the **Stamp...** button and **Background** cannot be used.

3. Click **Select Background...**

The **Background Settings** dialog box opens.

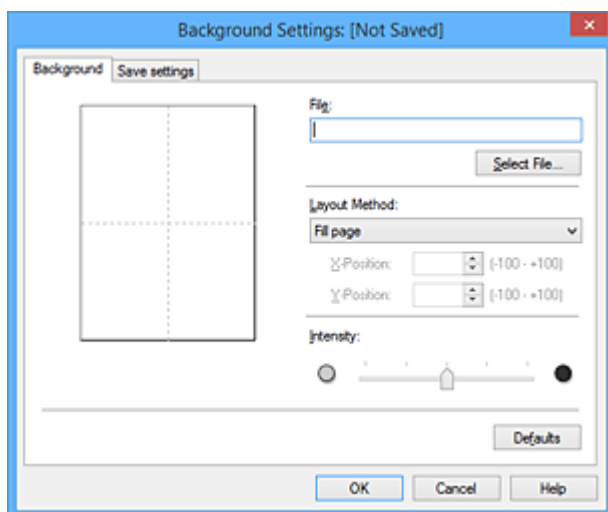

4. Select the image data to be registered to the background

Click **Select File....** Select the target bitmap file (.bmp), and then click **Open**.

5. Specify the following settings while viewing the preview window

Layout Method

Select how the background image data is to be placed.

When **Custom** is selected, you can set coordinates for **X-Position** and **Y-Position**.

You can also change the background position by dragging the image in the preview window.

Intensity

Set the intensity of the background image data with the **Intensity** slider. Moving the slider to the right darkens the background, and moving the slider to the left lightens the background. To print the background at the original bitmap intensity, move the slider to the rightmost position.

6. Save the background

Click the **Save settings** tab and enter a title in the **Title** box, and then click **Save**.

Click **OK** when the confirmation message appears.

➤➤➤ Note

- Spaces, tabs, and returns cannot be entered at the beginning or end of a title.

7. Complete the setup

Click **OK**, then it returns to **Stamp/Background** dialog box.

The registered title appears in the **Background** list.

Changing and Registering Some Background Settings

1. Select the background for which the settings are to be changed

Select the **Background** check box in the **Stamp/Background** dialog box. Then from the list, select the title of the background you want to change.

2. Click **Select Background...**

The **Background Settings** dialog box opens.

3. Specify each item on the **Background** tab while viewing the preview window

4. Save the background

Click **Save overwrite** on the **Save settings** tab. When you want to save the background with a different title, enter a new title in the **Title** box and click **Save**.

Click **OK** when the confirmation message appears.

5. Complete the setup

Click **OK**, then it returns to **Stamp/Background** dialog box.

The registered title appears in the **Background** list.

Deleting an Unnecessary Background

1. Click **Select Background...** in the **Stamp/Background** dialog box

The **Background Settings** dialog box opens.

2. Select the background to be deleted

Select the title of the background you want to delete from the **Backgrounds** list on the **Save settings** tab, and then click **Delete**.

Click **OK** when the confirmation message appears.

3. Complete the setup

Click **OK**, then it returns to **Stamp/Background** dialog box.

Setting Up Envelope Printing

The procedure for performing envelope printing is as follows:

1. [Load envelope](#) on the printer
2. Open the [printer driver setup window](#)
3. Select the media type

Select **Envelope** from **Commonly Used Settings** on the **Quick Setup** tab.

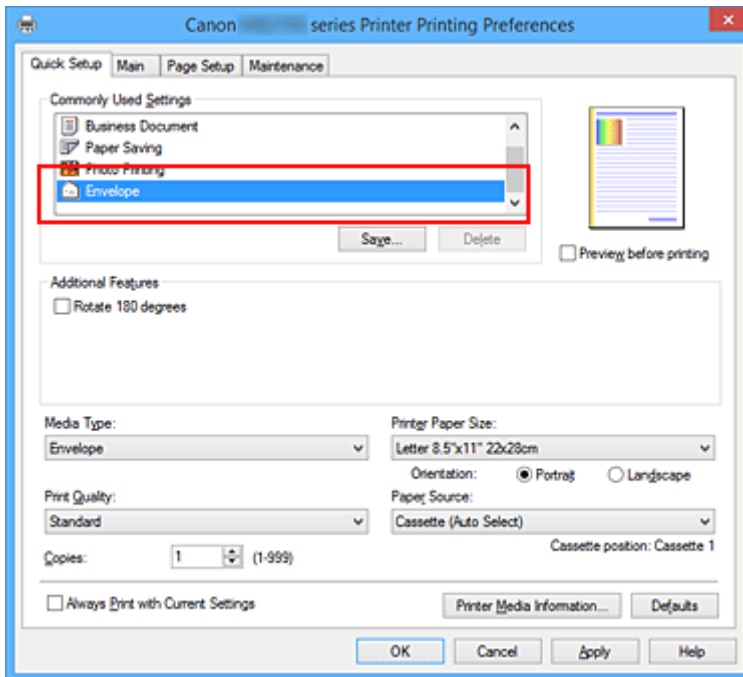

4. Select the paper size

When the **Envelope Size Setting** dialog box is displayed, select **Envelope Com 10**, **Envelope DL**, **Yougata 4 4.13"x9.25"**, **Yougata 6 3.86"x7.48"**, **Envelope C5**, or **Envelope Monarch 3.88"x7.5" 98.4x190.5mm** and then click **OK**.

5. Set the orientation

To print the addressee horizontally, select **Landscape** for **Orientation**.

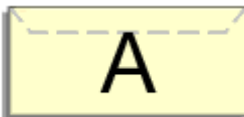

►►► Note

- If **Yougata 4 4.13"x9.25"**, **Yougata 6 3.86"x7.48"**, **Envelope Com 10**, **Envelope DL**, **Envelope C5**, or **Envelope Monarch 3.88"x7.5" 98.4x190.5mm** is selected for **Printer Paper Size**, the

printer rotates the paper 90 degrees to the left to print, regardless of the **Rotate 90 degrees left when orientation is [Landscape]** setting for **Custom Settings** on the **Maintenance** tab.

6. Select the print quality

Select **High** or **Standard** that matches your purpose for **Print Quality**.

7. Complete the setup

Click **OK**.

When you execute print, the information is printed on the envelope.

▶▶▶ Important

- When you execute envelope printing, guide messages are displayed.
To hide the guide messages, check the **Do not show this message again** check box.
To show the guide again, click the **View Printer Status** button on the **Maintenance** tab, and start the Canon IJ Status Monitor.
Then click **Envelope Printing** from **Display Guide Message** of the **Option** menu to enable the setting.

▶▶▶ Note

- If the paper settings on the printer driver differ from the cassette paper information registered on the printer, an error may occur. For instructions on what to do if an error occurs, see "[Paper Settings](#)."
To check the current printer settings or to apply the printer settings to the printer driver, click **Printer Media Information...** from the **Quick Setup** tab, and specify the settings in the dialog box that appears.
For details about the cassette paper information to be registered on the printer, see the following:
 - [Paper Settings on the Printer Driver and the Printer \(Media Type\)](#)
 - [Paper Settings on the Printer Driver and the Printer \(Paper Size\)](#)

Printing on Postcards

This section describes the procedure for postcard printing.

1. [Load postcard](#) on the printer
2. Open the [printer driver setup window](#)

3. Select commonly used settings

Display the **Quick Setup** tab, and for **Commonly Used Settings**, select **Standard**.

4. Select the media type

For **Media Type**, select **Ink Jet Hagaki (A)**, **Ink Jet Hagaki**, **Hagaki K (A)**, **Hagaki K**, **Hagaki (A)**, or **Hagaki**.

▶▶▶ Important

- This printer cannot print on postcards that have photos or stickers attached.
- When printing on each side of a postcard separately, you will get cleaner printing if you print the message side first and then print the address side.
- The paper settings on the printer driver are different, depending on whether you are printing on the address side or the message side.
To check the current printer settings or to apply the printer settings to the printer driver, click **Printer Media Information...** from the **Quick Setup** tab, and specify the settings in the dialog box that appears.
For details about the cassette paper information to be registered to the printer driver and on the printer, see the following:
 - [Paper Settings on the Printer Driver and the Printer \(Media Type\)](#)
 - [Paper Settings on the Printer Driver and the Printer \(Paper Size\)](#)

5. Select the paper size

For **Printer Paper Size**, select **Hagaki 100x148mm** or **Hagaki 2 200x148mm**.

▶▶▶ Important

- Return postcards can be used only when you print them from the computer.
- When printing a return postcard, always set the paper size to **Hagaki 2 200x148mm** from your application software or the printer driver.
- Do not fold the return postcard. If a crease is formed, the printer will not be able to feed the postcard properly, and this condition will cause line shifts or a paper jam.

6. Set the print orientation

To print the address horizontally, set **Orientation** to **Landscape**.

7. Select the print quality

For **Print Quality**, select **High** or **Standard**, according to your purpose.

8. Complete the setup

Click **OK**.

When you execute printing, the data will be printed onto the postcard.

»» Important

- When you execute postcard printing, a guide message is displayed.
When the guide message is displayed, select **Do not show this message again** if you do not want any guide messages to be displayed.
To display guide messages again, open the **Maintenance** tab and click **View Printer Status** to start the Canon IJ Status Monitor.
On the **Option** menu, choose **Display Guide Message** and click **Hagaki Printing** to enable the setting.
- When printing on media other than postcards, load the media according to usage method of that media, and click **Start Printing**.

Switching the Paper Source to Match the Purpose

In this printer, there are two paper sources, a cassette 1 and a cassette 2.

You can facilitate printing by selecting a paper source setting that matches your media type or purpose.

The procedure for setting paper source is as follows:

You can also set the paper source on the **Quick Setup** tab.

1. Open the [printer driver setup window](#)

2. Select the media type

Select the type of paper loaded in the printer from the **Media Type** list on the **Main** tab.

3. Select the paper source

From the **Paper Source** list, select the paper source that matches your purpose.

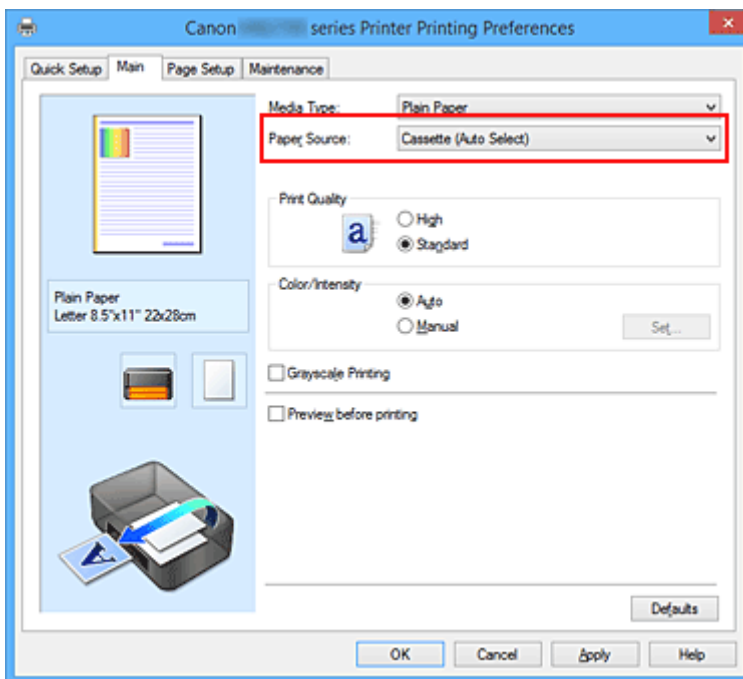

Cassette (Auto Select)

Based on the paper settings on the printer driver and the cassette paper information registered on the printer, the printer automatically determines which cassette to use and feeds paper from that cassette.

Cassette 1

Paper is fed from the cassette 1.

Cassette 2

Paper is fed from the cassette 2.

►►► Important

- When a media type other than **Plain Paper** is selected for **Media Type** on the **Main** tab, paper cannot be supplied from the cassette 2.

- When a paper size other than **Letter 8.5"x11" 22x28cm**, **Legal 8.5"x14" 22x36cm**, **A4**, **Oficio 8.5"x12.5" 215.9x317.5mm**, **B-Oficio 8.5"x14" 216.0x355.0mm**, **M-Oficio 8.50"x13.43" 216.0x341.0mm**, **Foolscap 8.5"x13" 215.9x330.2mm**, or **Legal (India) 8.46"x13.58" 215x345mm** is selected for **Page Size** on the **Page Setup** tab, paper cannot be supplied from the cassette 2.

4. Complete the setup

Click **OK**.

When you execute print, the printer uses the specified paper source to print the data.

Note

- If the paper settings on the printer driver differ from the cassette paper information registered on the printer, an error may occur. For instructions on what to do if an error occurs, see "[Paper Settings](#)."
To check the current printer settings or to apply the printer settings to the printer driver, click **Printer Media Information...** from the **Quick Setup** tab, and specify the settings in the dialog box that appears.
For details about the cassette paper information to be registered on the printer, see the following:
 - [Paper Settings on the Printer Driver and the Printer \(Media Type\)](#)
 - [Paper Settings on the Printer Driver and the Printer \(Paper Size\)](#)

Displaying the Print Results before Printing

If you are using the XPS printer driver, replace "Canon IJ Preview" with "Canon IJ XPS Preview" when reading this information.

You can display and check the print result before printing.

The procedure for displaying the print result before printing is as follows:

You can also set the print results display on the **Quick Setup** tab.

1. Open the [printer driver setup window](#)

2. Set the preview

Check the **Preview before printing** check box on the **Main** tab.

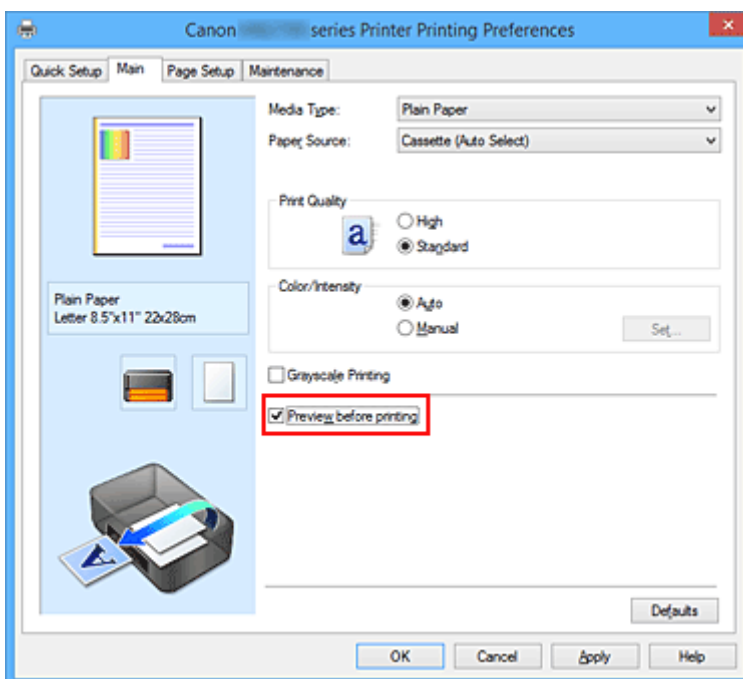

3. Complete the setup

Click **OK**.

When you execute print, the Canon IJ Preview opens and displays the print results.

Important

- In the **Manual Color Adjustment** dialog box, the **Color Adjustment** tab contains the **Print a pattern for color adjustment** check box. When this check box is selected, the **Preview before printing** appears grayed out and is unavailable.

Related Topic

- [Canon IJ Preview](#)

Setting Paper Dimensions (Custom Size)

You can specify the height and width of paper when its size cannot be selected from the **Page Size**. Such a paper size is called "custom size."

The procedure for specifying a custom size is as follows:

You can also set a custom size in **Printer Paper Size** on the **Quick Setup** tab.

1. Open the [printer driver setup window](#)
2. Select the paper size

Select **Custom...** for **Page Size** on the **Page Setup** tab.

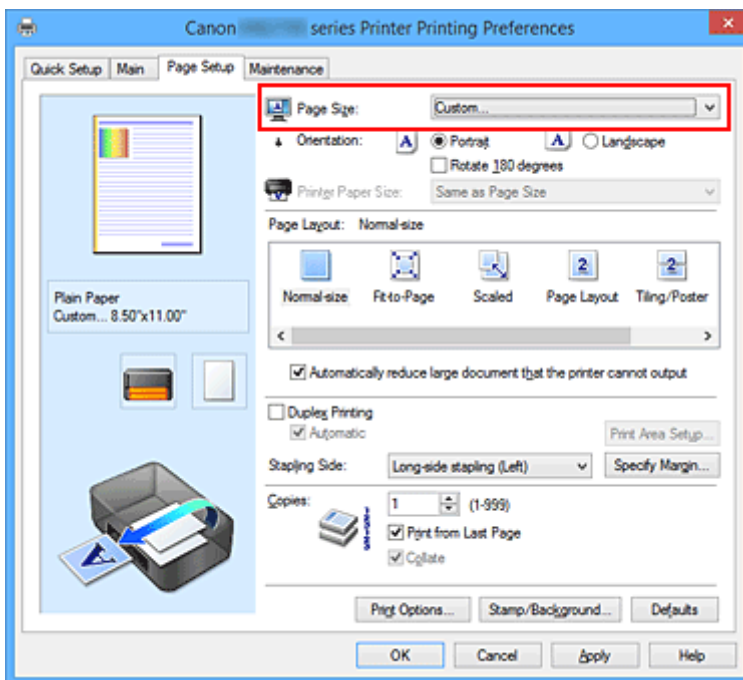

The **Custom Paper Size** dialog box opens.

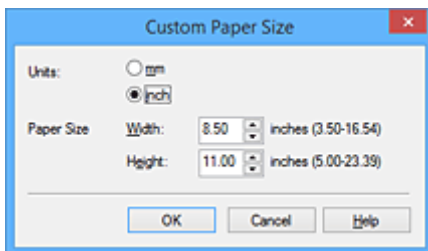

3. Set the custom paper size

Specify **Units**, and enter the **Width** and **Height** of the paper to be used. Then click **OK**.

4. Complete the setup

Click **OK** on the **Page Setup** tab.

When you execute print, the data is printed with the specified paper size.

»» Important

- If the application software that created the document has a function for specifying height and width values, use the application software to set the values. If the application software does not have such a function or if the document does not print correctly, perform the above procedure from the printer driver to set the values.
- Printing may be disabled depending on the size of the specified user-defined media. For information about printable sizes for user-defined media, see "[Supported Media Types](#)."

»» Note

- If the paper settings on the printer driver differ from the cassette paper information registered on the printer, an error may occur. For instructions on what to do if an error occurs, see "[Paper Settings](#)." To check the current printer settings or to apply the printer settings to the printer driver, click **Printer Media Information...** from the **Quick Setup** tab, and specify the settings in the dialog box that appears. For details about the cassette paper information to be registered on the printer, see the following:
 - [Paper Settings on the Printer Driver and the Printer \(Media Type\)](#)
 - [Paper Settings on the Printer Driver and the Printer \(Paper Size\)](#)

Editing the Print Document or Reprinting from the Print History

This function is unavailable when the standard IJ printer driver is used.

In the Canon IJ XPS preview window, you can edit the print document or retrieve the document print history to print the document.

The procedure for using the Canon IJ XPS Preview is as follows:

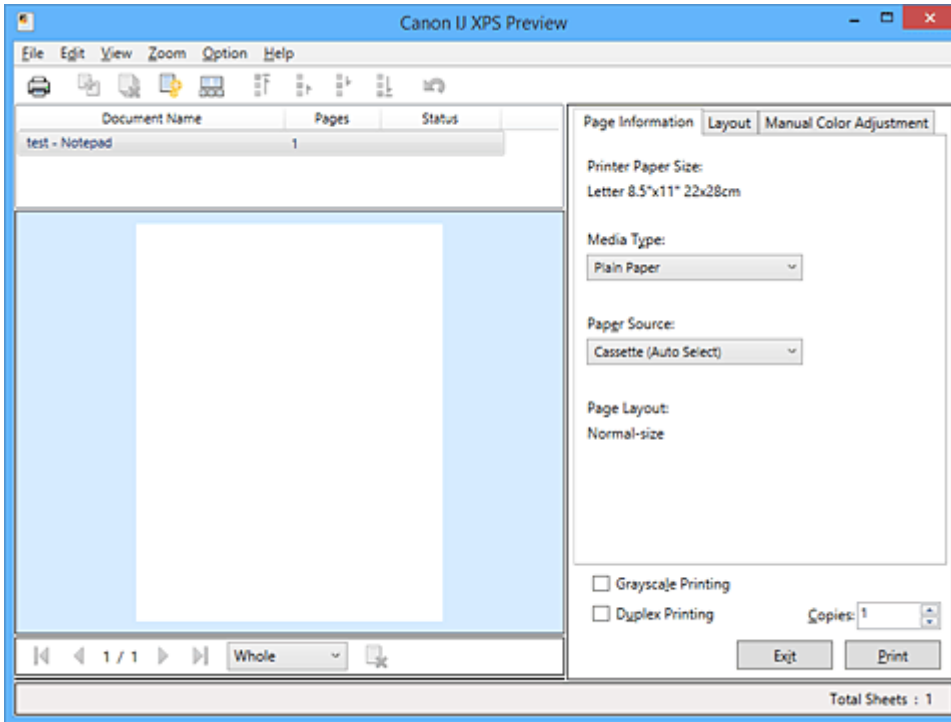

Print



Combine Documents



Delete Document



Reset Documents



View Thumbnails



Move Document



Undo





Move Page



Delete Page

▶▶▶ Note

- By clicking  **View Thumbnails**, you can display or hide thumbnails of the print documents selected in the **Document Name** list.
- Clicking  **Undo** reverses the change that just performed.

Editing and Printing a Print Document

When printing multiple documents or pages, you can combine documents, change the print sequence of the documents or pages, or delete documents or pages.

1. Open the [printer driver setup window](#)

2. Set the preview

Check the **Preview before printing** check box on the **Main** tab.

3. Complete the setup

Click **OK**.

The Canon IJ XPS Preview will start and the print result will be displayed before printing.

4. Editing print documents and print pages

- Combining print documents

You can combine multiple print documents to form a single document. By combining print documents, you can prevent blank pages from being inserted when you execute duplex printing or page layout printing.

From the **Document Name** list, select the documents to be combined. On the **Edit** menu, select **Combine Documents** from **Documents** to combine the documents in the listed sequence.

To select multiple print documents, hold down the Ctrl key and click the documents to be merged, or hold down the Shift key and press the upper arrow or lower arrow key. You can also click a blank area in the document list and drag the mouse to select multiple documents.

When you combine documents, the documents selected before the combining are deleted from the list and the combined document is added to the list.

- Changing the sequence of print documents or print pages

- To change the sequence of the print documents, go to the **Document Name** list, and select the print document to be moved. Next, on the **Edit** menu, select **Move Document** from **Documents**, and select the appropriate item. You can also click and drag a print document to change the print sequence.

- To change the sequence of the print pages, click **View Thumbnails** from the **Option** menu, and select the print page to be moved. Next, on the **Edit** menu, select **Move Page** from **Pages**, and select the appropriate item. You can also click and drag a print page to change the print sequence.

- Deleting print documents and print pages

- To delete a print document, select the target document from the **Document Name** list, and on the **Edit** menu, choose **Documents** and then **Delete Document**.
- To delete a print page, click **View Thumbnails** from the **Option** menu, and select the print page to be deleted. Next, on the **Edit** menu, select **Delete Page** from **Pages**.

- Print page recovery

You can recover pages that were deleted with **Delete Page**.

To recover pages, select the **View Deleted Pages** check box from the **Option** menu, and select

the pages to be recovered from among the displayed thumbnail pages. Then from the **Edit** menu chose **Pages** and then **Restore Page**.

After editing the print documents or print pages, you can change the print settings on the **Page Information**, **Layout** and **Manual Color Adjustment** tabs as necessary.

▶▶▶ Important

- To display the multiple documents in the list, open the preview and execute print again.
- To return the print documents to their original condition before they were edited in the preview, on the **Edit** menu, select **Reset Documents** from **Documents**.
- If the documents to be combined have different print settings, a message may be displayed. Check the contents of the displayed message before combining the documents.
- If the documents to be combined have different output paper sizes and duplex printing or page layout printing is to be performed, the printer may not produce the expected print results for certain print pages.
Check the preview before printing.
- Depending on the print settings of the print document, some functions may not be available in the Canon IJ XPS preview.

▶▶▶ Note

- You can rename **Document Name** to any name.

5. Executing print

Click **Print**.

When you execute print, the printer uses the specified settings to print the data.

Reprinting from the Print History

When you click **Save Print History** on the **File** menu to enable the setting, the document printed from the preview is saved, and you can reprint the document with the same settings.

1. Displaying the print history

Open the [printer driver setup window](#). Then on the **Maintenance** tab, select **View Print History**. The saved print document is displayed in the preview.

▶▶▶ Important

- To limit the number of print history registrations, click **History Entry Limit** on the **File** menu.
- If the limit on the number of registration is exceeded, the print history registrations are deleted starting from the oldest one.

2. Selecting a print document

From the **Document Name** list, select the document to be printed.

3. Executing print

Click **Print**.

Related Topic

- [Displaying the Print Results before Printing](#)

Changing the Print Quality and Correcting Image Data

- **Printing a Color Document in Monochrome**
- **Specifying Color Correction**
- **Optimal Photo Printing of Image Data**
- **Adjusting Colors with the Printer Driver**
- **Printing with ICC Profiles**
- **Adjusting Color Balance**
- **Adjusting Color Balance Using Sample Patterns (Printer Driver)**
- **Adjusting Brightness**
- **Adjusting Intensity**
- **Adjusting Contrast**
- **Adjusting Intensity/Contrast Using Sample Patterns (Printer Driver)**

Printing a Color Document in Monochrome

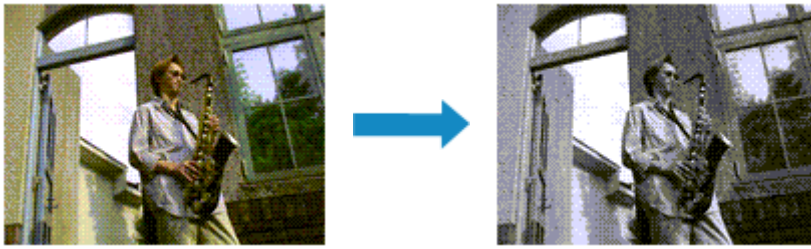

The procedure for printing a color document in monochrome is as follows:

You can also set a grayscale printing in **Additional Features** on the **Quick Setup** tab.

1. Open the [printer driver setup window](#)
2. Set grayscale printing

Check the **Grayscale Printing** check box on the **Main** tab.

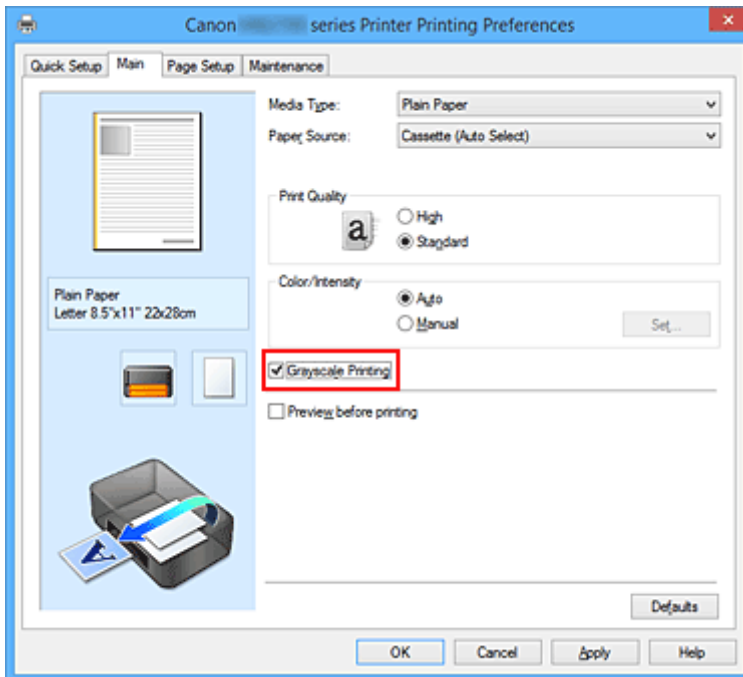

3. Complete the setup

Click **OK**.

When you execute print, the document is converted to grayscale data. It allows you to print the color document in monochrome.

►► Important

- When the **Grayscale Printing** check box is checked, the printer driver processes image data as sRGB data. In this case, actual colors printed may differ from those in the original image data. When using the grayscale printing function to print Adobe RGB data, convert the data to sRGB data using an application software.

»» Note

- During **Grayscale Printing**, inks other than black ink may be used as well.

Specifying Color Correction

You can specify the color correction method suited to the type of document to be printed.

Normally, the printer driver adjusts the colors by using Canon Digital Photo Color so that data is printed with color tints that most people prefer. This method is suitable for printing sRGB data.

When you want to print by using the color space (sRGB) of the image data effectively, select **ICM (ICC Profile Matching)**. When you want to use an application software to specify a printing ICC profile, select **None**.

The procedure for specifying color correction is as follows:

You can also set color correction on the **Quick Setup** tab by choosing **Photo Printing** under **Commonly Used Settings**, and then choosing **Color/Intensity Manual Adjustment** under **Additional Features**.

1. Open the [printer driver setup window](#)
2. Select the manual color adjustment

On the **Main** tab, select **Manual** for **Color/Intensity**, and click **Set...**

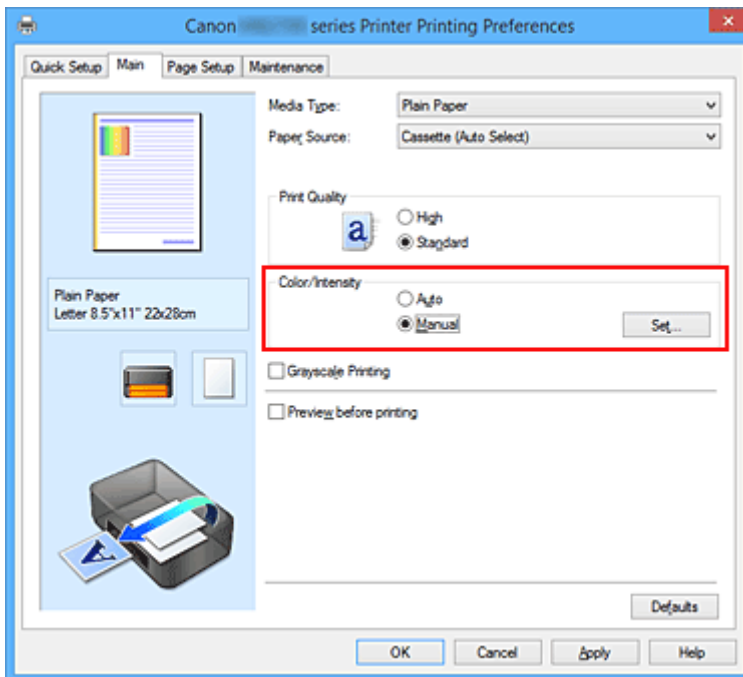

The **Manual Color Adjustment** dialog box opens.

3. Select color correction

Click **Matching** tab, select **Color Correction** setting that matches your purpose from the following, and click **OK**.

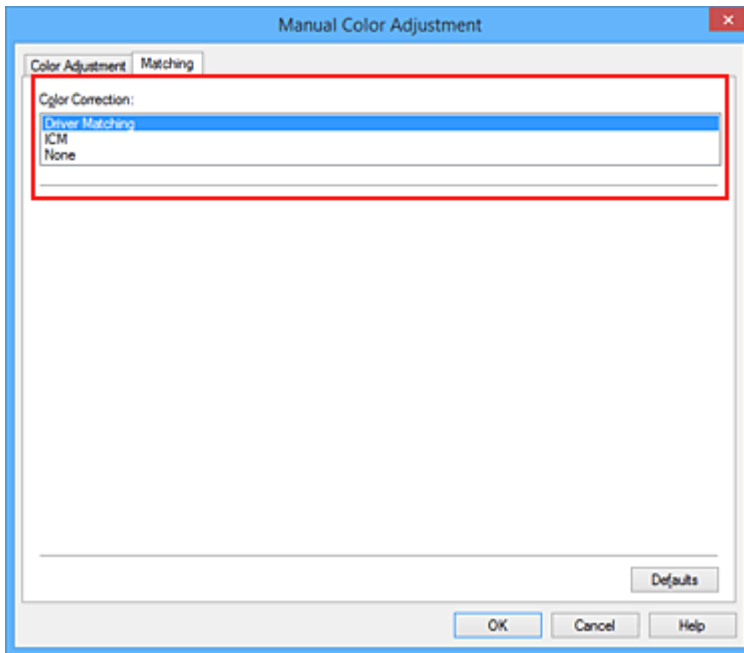

Driver Matching

With Canon Digital Photo Color, you can print sRGB data with color tints that most people prefer.

ICM (ICC Profile Matching)

Adjusts the colors by using an ICC profile when printing.

None

The printer driver does not perform color correction. Select this value when you are specifying an individually created printing ICC profile or a printing ICC profile for special Canon paper in an application software to print data.

4. Complete the setup

Click **OK** on the **Main** tab.

When you execute print, the document data is printed with the specified color correction.

▶▶▶ Important

- When ICM is disabled in the application software, **ICM** is unavailable for **Color Correction** and the printer may not be able to print the image data properly.
- When the **Grayscale Printing** check box on the **Main** tab is checked, **Color Correction** appears grayed out and is unavailable.

Related Topics

- [Optimal Photo Printing of Image Data](#)
- [Adjusting Colors with the Printer Driver](#)
- [Printing with ICC Profiles](#)

Optimal Photo Printing of Image Data

When people print images taken with digital cameras, they sometimes feel that the printed color tones differ from those of actual image or those displayed on the monitor.

To get the print results as close as possible to the desired color tones, you must select a printing method that is best suited to the application software used or to your purpose.

Color Management

Devices such as digital cameras, scanners, monitors, and printers handle color differently. Color management (color matching) is a method that manages device-dependent "colors" as a common color space.

For Windows, a color management system called "ICM" is built into the operating system. sRGB is one of the common color spaces that is frequently used.

ICC profiles convert device-dependent "colors" into a common color space. By using an ICC profile and carrying out color management, you can draw out the color space of the image data within the color reproduction area that the printer can express.

Selecting a Printing Method Suited to the Image Data

The recommended printing method depends on the color space (sRGB) of the image data or the application software to be used.

There are two typical printing methods.

Check the color space (sRGB) of the image data and the application software to be used, and then select the printing method suited to your purpose.

Adjusting Colors with the Printer Driver

Describes the procedure for printing sRGB data by using the color correction function of the printer driver.

- To print using Canon Digital Photo Color

The printer prints data with color tints that most people prefer, reproducing colors of the original image data and producing three-dimensional effects and high, sharp contrasts.

- To print by directly applying editing and touch-up results of an application software

When printing the data, the printer brings out subtle color difference between dark and light areas, while leaving the darkest and lightest areas intact.

When printing the data, the printer applies fine adjustment results, such as brightness adjustments made with an application software.

Printing with ICC Profiles

Describes the procedure for printing by using the color space of sRGB effectively.

You can print with a common color space by setting up the application software and the printer driver so that the color management matches the input ICC profile of the image data.

The method for setting up the printer driver differs depending on the application software to be used.

Adjusting Colors with the Printer Driver

You can specify the color correction function of the printer driver to print sRGB data with color tints that most people prefer through the use of Canon Digital Photo Color.

When printing from an application software that can identify ICC profiles and allows you to specify them, use a printing ICC profile in the application software, and select settings for color management.

The procedure for adjusting colors with the printer driver is as follows:

1. Open the [printer driver setup window](#)

2. Select the manual color adjustment

On the **Main** tab, select **Manual** for **Color/Intensity**, and click **Set...**

The **Manual Color Adjustment** dialog box opens.

3. Select color correction

Click **Matching** tab, and select **Driver Matching** for **Color Correction**.

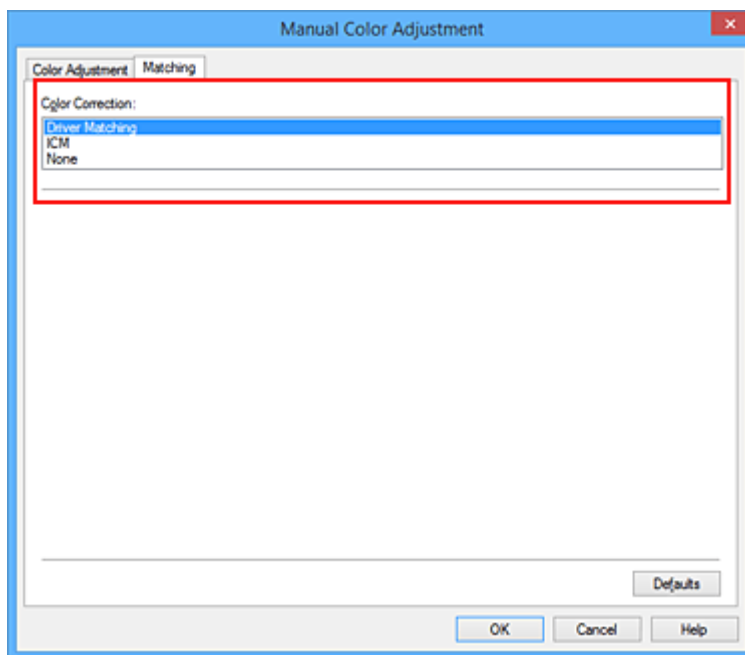

4. Set the other items

If necessary, click **Color Adjustment** tab, and adjust the color balance (**Cyan**, **Magenta**, **Yellow**) and adjust **Brightness**, **Intensity**, and **Contrast** settings, and then click **OK**.

5. Complete the setup

Click **OK** on the **Main** tab.

When you execute print, the printer driver adjusts the colors when printing the data.

Related Topics

- [Specifying Color Correction](#)

- [Adjusting Color Balance](#)
- [Adjusting Brightness](#)
- [Adjusting Intensity](#)
- [Adjusting Contrast](#)

Printing with ICC Profiles

When the image data has a specified input ICC profile, you can print by using the color space (sRGB) of the data effectively.

The printer driver setting procedure varies depending on the application software used to print.

Specify an ICC Profile from the Application Software and Print the Data

When you print the editing and touch-up results of Adobe Photoshop, Canon Digital Photo Professional, or any application software that allows you to specify input and printing ICC profiles, you print by effectively using the color space of the input ICC profile specified in the image data.

To use this printing method, use your application software to select color management items and specify an input ICC profile and a printing ICC profile in the image data.

Even if you print using a printing ICC profile that you created yourself from your application software, be sure to select color management items from your application software.

For instructions, refer to the manual of the application software you are using.

1. Open the [printer driver setup window](#)
2. Select the manual color adjustment

On the **Main** tab, select **Manual** for **Color/Intensity**, and click **Set...**

The **Manual Color Adjustment** dialog box opens.

3. Select color correction

Click **Matching** tab, and select **None** for **Color Correction**.

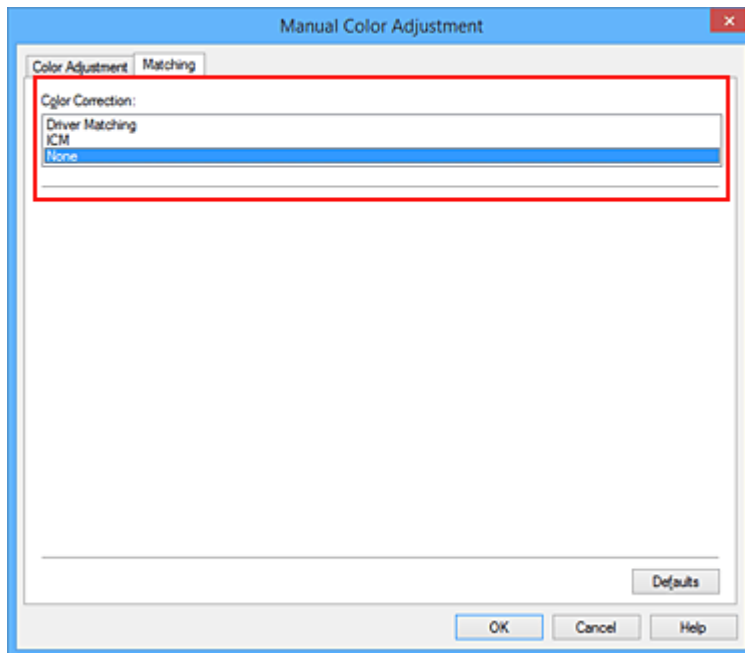

4. Set the other items

If necessary, click **Color Adjustment** tab, and adjust the color balance (**Cyan, Magenta, Yellow**) and adjust **Brightness, Intensity, and Contrast** settings, and then click **OK**.

5. Complete the setup

Click **OK** on the **Main** tab.

When you execute print, the printer uses the color space of the image data.

Specify an ICC Profile with the Printer Driver, and then Print

Print from an application software that cannot identify input ICC profiles or does allow you to specify one by using the color space of the input ICC profile (sRGB) found in the data.

1. Open the [printer driver setup window](#)

2. Select the manual color adjustment

On the **Main** tab, select **Manual** for **Color/Intensity**, and click **Set....**

The **Manual Color Adjustment** dialog box opens.

3. Select color correction

Click **Matching** tab, and select **ICM (ICC Profile Matching)** for **Color Correction**.

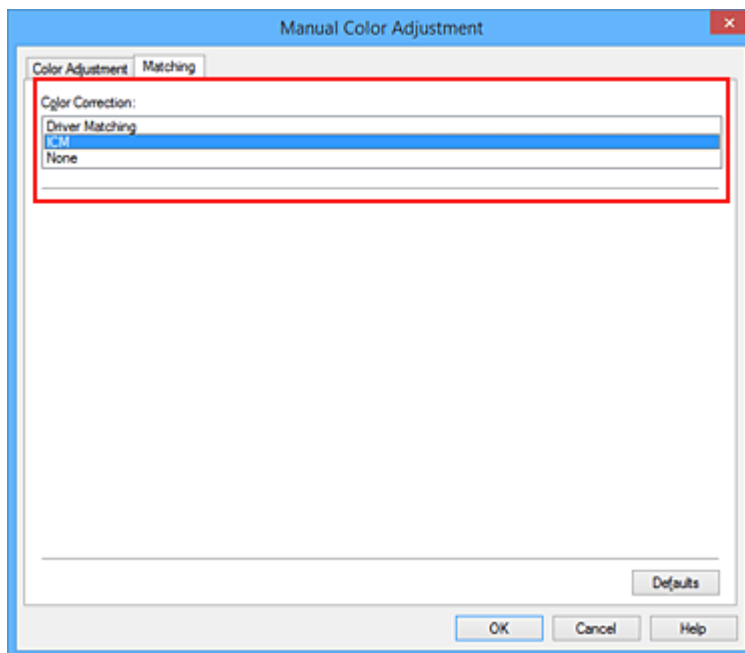

4. Set the other items

If necessary, click **Color Adjustment** tab, and adjust **Cyan, Magenta, Yellow, Brightness, Intensity, and Contrast** settings, and then click **OK**.

5. Complete the setup

Click **OK** on the **Main** tab.

When you execute print, the printer uses the color space of the image data.

Related Topics

- [Specifying Color Correction](#)
- [Adjusting Color Balance](#)
- [Adjusting Brightness](#)
- [Adjusting Intensity](#)
- [Adjusting Contrast](#)

Adjusting Color Balance

You can adjust the color tints when printing.

Since this function adjusts color balance of the output by changing the ink ratios of each color, it changes the total color balance of the document. Use the application software when you want to change the color balance significantly. Use the printer driver only when you want to adjust the color balance slightly.

The following sample shows the case when color balance is used to intensify cyan and to diminish yellow so that the overall colors are more uniform.



No adjustment Adjust color balance

The procedure for adjusting color balance is as follows:

You can also set color balance on the **Quick Setup** tab by choosing **Photo Printing** under **Commonly Used Settings**, and then choosing **Color/Intensity Manual Adjustment** under **Additional Features**.

1. Open the [printer driver setup window](#)
2. Select the manual color adjustment

On the **Main** tab, select **Manual** for **Color/Intensity**, and click **Set...**

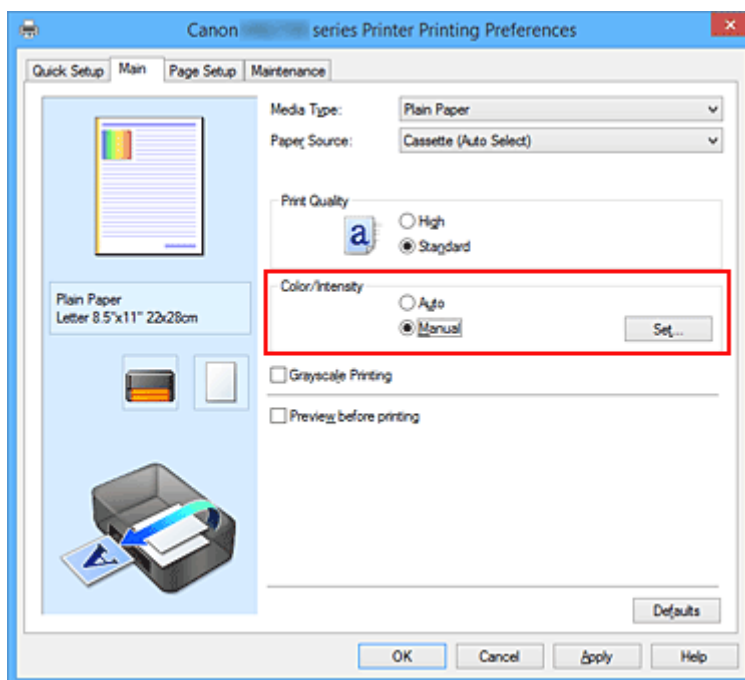

The **Manual Color Adjustment** dialog box opens.

3. Adjust color balance

There are individual sliders for **Cyan**, **Magenta**, and **Yellow**. Each color becomes stronger when the corresponding slider is moved to the right, and becomes weaker when the corresponding slider is moved to the left. For example, when cyan becomes weaker, the color red becomes stronger.

You can also directly enter a value linked to the slider. Enter a value in the range from -50 to 50. The current settings are displayed in the settings preview on the left side of the printer driver.

After adjusting each color, click **OK**.

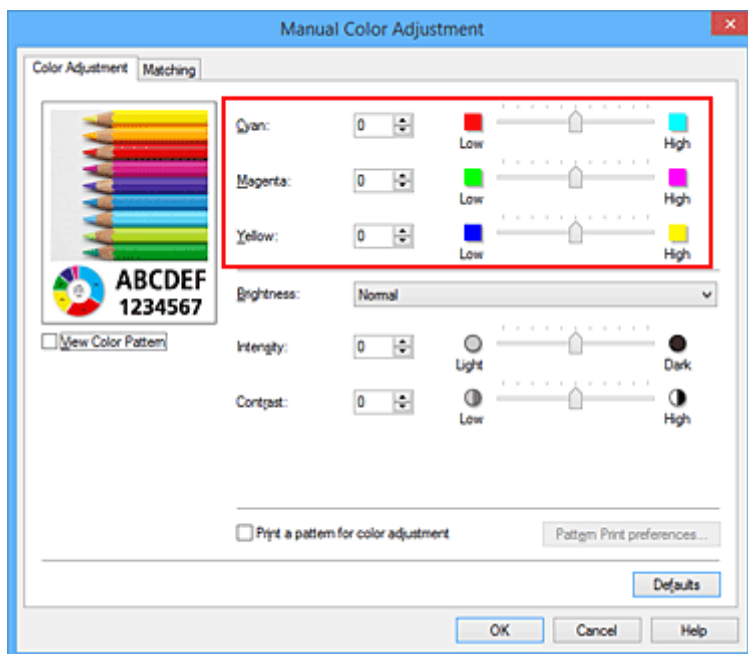

4. Complete the setup

Click **OK** on the **Main** tab.

When you execute print, the document is printed with the adjusted color balance.

▶▶▶ Important

- When the **Grayscale Printing** check box on the **Main** tab is checked, the color balance (**Cyan**, **Magenta**, **Yellow**) appear grayed out and are unavailable.

Related Topics

- [Specifying Color Correction](#)
- [Adjusting Color Balance Using Sample Patterns \(Printer Driver\)](#)
- [Adjusting Brightness](#)
- [Adjusting Intensity](#)
- [Adjusting Contrast](#)
- [Adjusting Intensity/Contrast Using Sample Patterns \(Printer Driver\)](#)

Adjusting Color Balance Using Sample Patterns (Printer Driver)

You can look at the print results of pattern print and adjust the color balance.

When you change the color balance or intensity/contrast of a document, the pattern print function prints the adjustment results in a list, together with the adjustment values.

Described below is the procedure for adjusting the color balance while looking at the pattern.

1. Open the [printer driver setup window](#)
2. Select the manual color adjustment

On the **Main** tab, select **Manual** for **Color/Intensity**, and click **Set....**

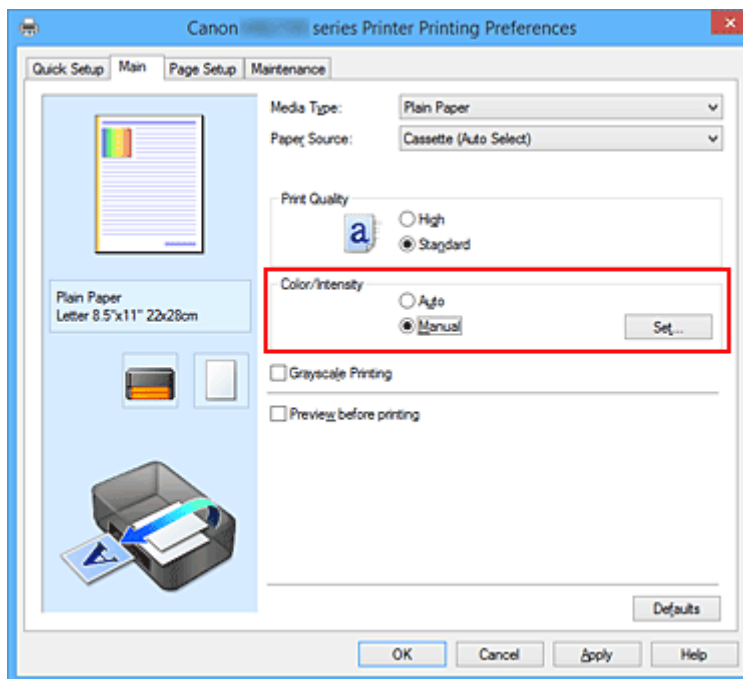

The **Manual Color Adjustment** dialog box opens.

3. Selecting pattern print

On the **Color Adjustment** tab, select the **Print a pattern for color adjustment** check box, and click **Pattern Print preferences....**

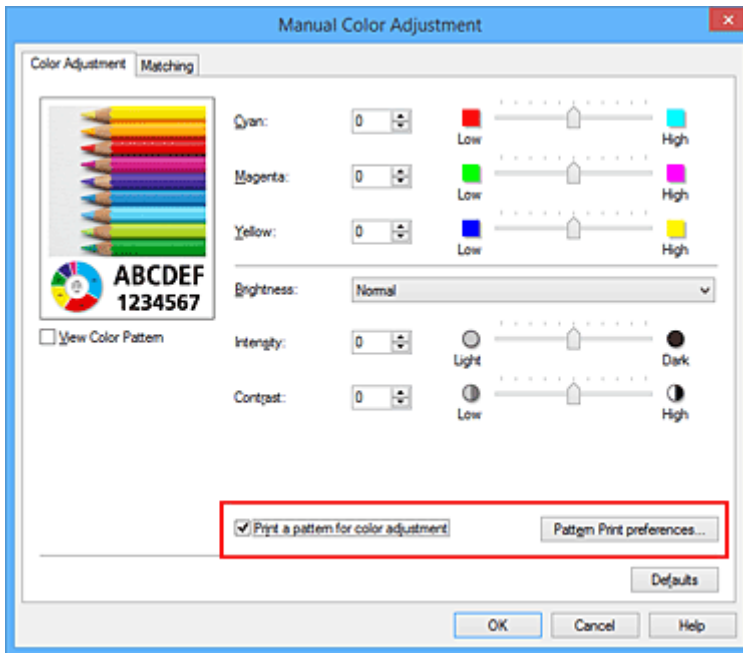

4. Setting pattern print

When the **Pattern Print** dialog box opens, set the following items, and then click **OK**.

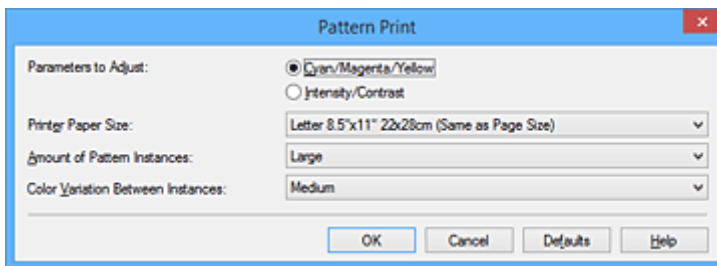

Parameters to Adjust

Select **Cyan/Magenta/Yellow**.

►►► Important

- When the **Grayscale Printing** check box on the **Main** tab is checked, **Cyan/Magenta/Yellow** appear grayed out and are unavailable.

Printer Paper Size

Select the paper size to be used for pattern printing.

►►► Note

- Depending on the paper size selected on the **Page Setup** tab, there may be sizes that cannot be selected.

Amount of Pattern Instances

Select **Largest**, **Large**, or **Small** to set the number of patterns to be printed.

►►► Note

- **Largest** and **Large** cannot be selected when certain paper sizes or output paper sizes are selected.

Color Variation Between Instances

Set the amount of color change between neighboring patterns.

►► Note

- **Large** is about double the size of **Medium**, and **Small** is about half the size of **Medium**.

5. Checking the print results of pattern print

On the **Color Adjustment** tab, select **OK** to close the **Manual Color Adjustment** dialog box.

On the **Main** tab, select **OK**, and then execute printing. The printer then prints a pattern in which the color balance that you set is the center value.



6. Adjusting the color balance

Look at the print results and select the image that you like best. Then enter the color balance numbers indicated at the bottom of that image into the **Cyan**, **Magenta**, and **Yellow** fields on the **Color Adjustment** tab.

Clear the **Print a pattern for color adjustment** check box, and click **OK**.

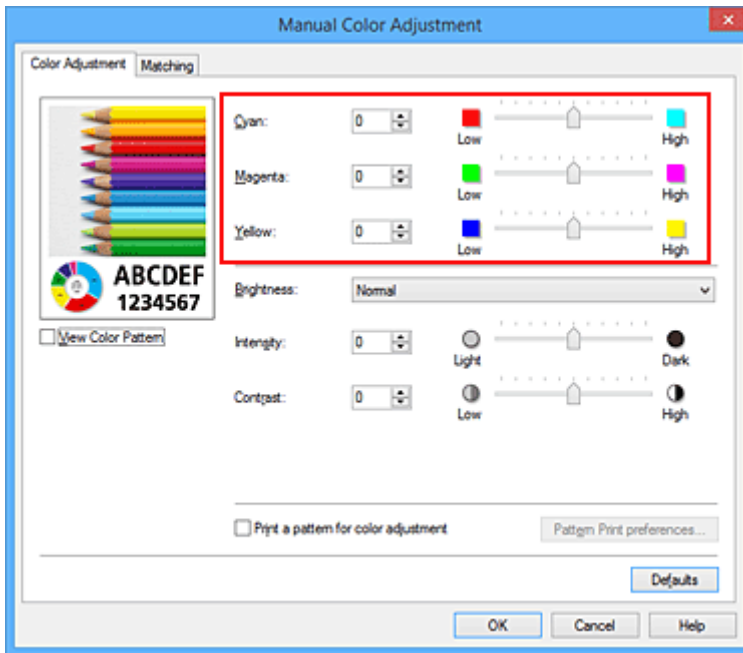

►► Note

- You can also set color balance on the **Quick Setup** tab by choosing **Photo Printing** under **Commonly Used Settings**, and then choosing **Color/Intensity Manual Adjustment** under **Additional Features**.

7. Complete the setup

Click **OK** on the **Main** tab.

Then when you execute printing, the document is printed with the color balance that was adjusted by the pattern print function.

►► Important

- When **Print a pattern for color adjustment** is selected on the **Color Adjustment** tab, the following items are grayed out and cannot be set:
 - **Preview before printing** on the **Main** tab
 - **Stapling Side** and **Specify Margin...** on the **Page Setup** tab (When **Duplex Printing** is set, only **Stapling Side** can be set.)
- When the **Print a pattern for color adjustment** on the **Color Adjustment** tab is checked, the **Page Layout** on the **Page Setup** tab is set to **Normal-size**.
- When the **Grayscale Printing** check box on the **Main** tab is checked, **Cyan**, **Magenta**, and **Yellow** appear grayed out and are unavailable.
- Depending on your application software, this function may not be available.

Related Topics

- [Adjusting Color Balance](#)
- [Adjusting Intensity](#)
- [Adjusting Contrast](#)
- [Adjusting Intensity/Contrast Using Sample Patterns \(Printer Driver\)](#)

Adjusting Brightness

You can change the brightness of the overall image data during printing.

This function does not change pure white or pure black but it changes the brightness of the intermediate colors.

The following sample shows the print result when the brightness setting is changed.



Light is selected



Normal is selected



Dark is selected

The procedure for adjusting brightness is as follows:

You can also set brightness on the **Quick Setup** tab by choosing **Photo Printing** under **Commonly Used Settings**, and then choosing **Color/Intensity Manual Adjustment** under **Additional Features**.

1. Open the [printer driver setup window](#)
2. Select the manual color adjustment

On the **Main** tab, select **Manual** for **Color/Intensity**, and click **Set...**

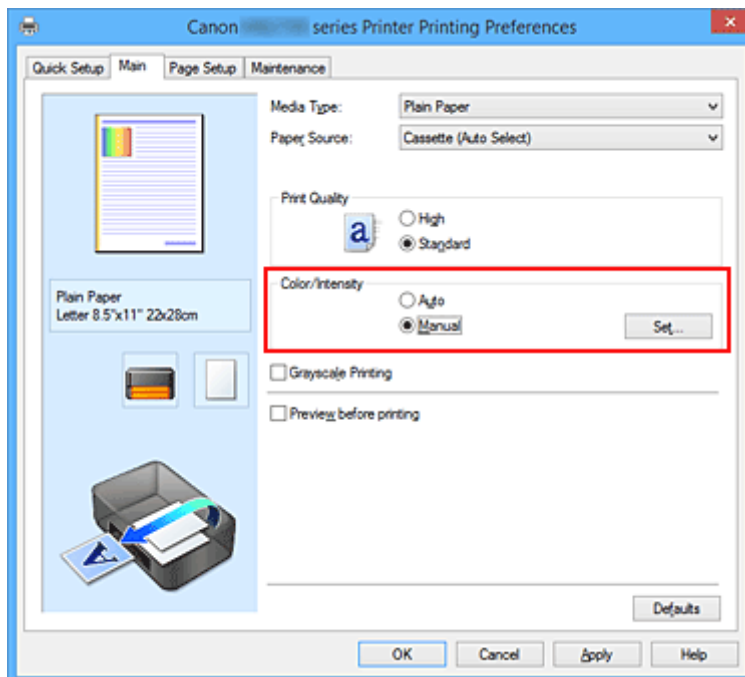

The **Manual Color Adjustment** dialog box opens.

3. Specify the brightness

Select **Light**, **Normal**, or **Dark** for **Brightness**, and click **OK**. The current settings are displayed in the settings preview on the left side of the printer driver.

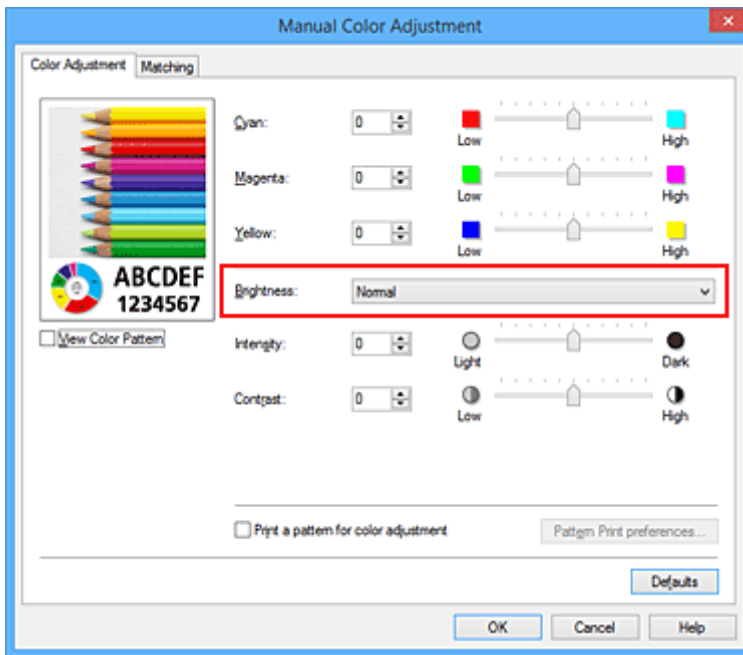

4. Complete the setup

Click **OK** on the **Main** tab.

When you execute print, the data is printed at the specified brightness.

Related Topics

- [Specifying Color Correction](#)
- [Adjusting Color Balance](#)
- [Adjusting Intensity](#)
- [Adjusting Contrast](#)

Adjusting Intensity

You can dilute (brighten) or intensify (darken) the colors of the overall image data during printing. The following sample shows the case when the intensity is increased so that all colors become more intense when the image data is printed.



No adjustment



Higher intensity

The procedure for adjusting intensity is as follows:

You can also set intensity on the **Quick Setup** tab by choosing **Photo Printing** under **Commonly Used Settings**, and then choosing **Color/Intensity Manual Adjustment** under **Additional Features**.

1. Open the [printer driver setup window](#)
2. Select the manual color adjustment

On the **Main** tab, select **Manual** for **Color/Intensity**, and click **Set...**

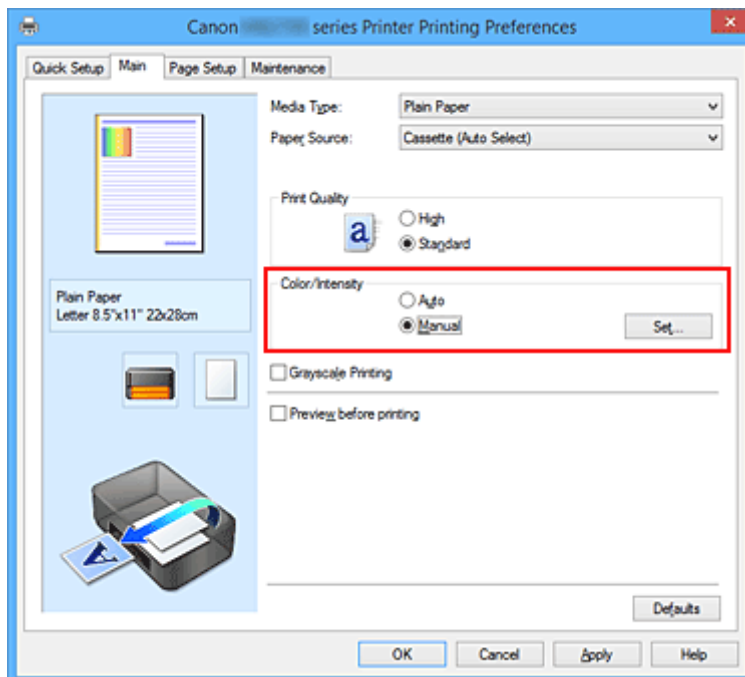

The **Manual Color Adjustment** dialog box opens.

3. Adjust intensity

Moving the **Intensity** slider to the right intensifies (darkens) the colors, and moving the slider to the left dilutes (brightens) the colors.

You can also directly enter a value linked to the slider. Enter a value in the range from -50 to 50. The current settings are displayed in the settings preview on the left side of the printer driver.

After adjusting each color, click **OK**.

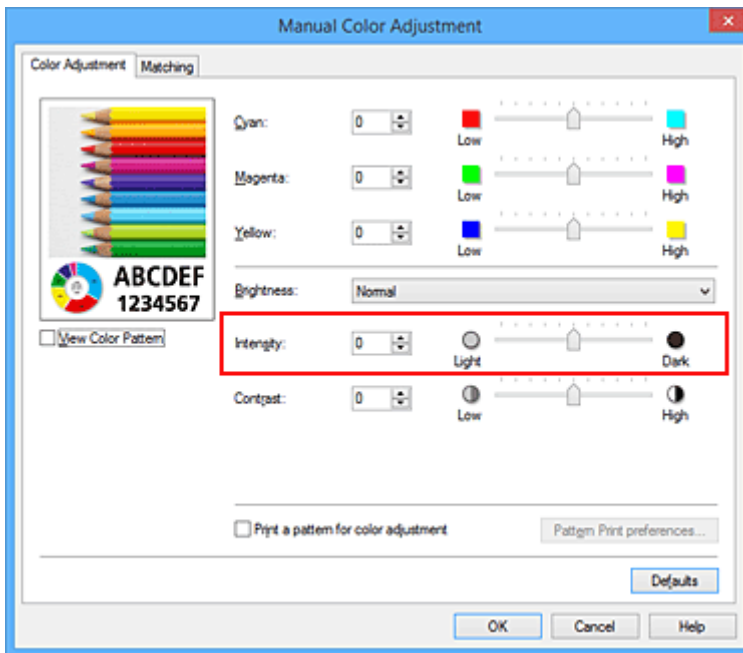

4. Complete the setup

Click **OK** on the **Main** tab.

When you execute print, the image data is printed with the adjusted intensity.

Related Topics

- [Specifying Color Correction](#)
- [Adjusting Color Balance](#)
- [Adjusting Color Balance Using Sample Patterns \(Printer Driver\)](#)
- [Adjusting Brightness](#)
- [Adjusting Contrast](#)
- [Adjusting Intensity/Contrast Using Sample Patterns \(Printer Driver\)](#)

Adjusting Contrast

You can adjust the image contrast during printing.

To make the differences between the light and dark portions of images greater and more distinct, increase the contrast. On the other hand, to make the differences between the light and dark portions of images smaller and less distinct, reduce the contrast.



No adjustment

Adjust the contrast

The procedure for adjusting contrast is as follows:

You can also set contrast on the **Quick Setup** tab by choosing **Photo Printing** under **Commonly Used Settings**, and then choosing **Color/Intensity Manual Adjustment** under **Additional Features**.

1. Open the [printer driver setup window](#)
2. Select the manual color adjustment

On the **Main** tab, select **Manual** for **Color/Intensity**, and click **Set...**

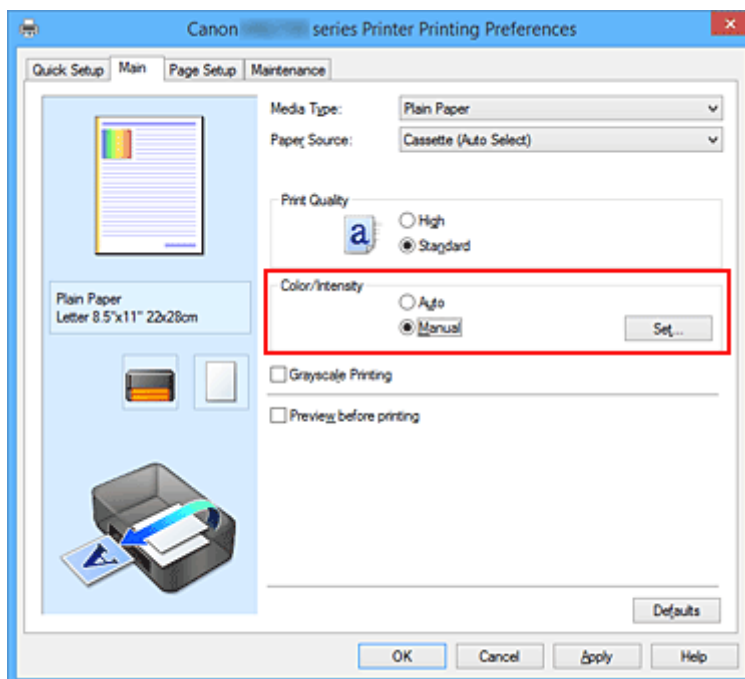

The **Manual Color Adjustment** dialog box opens.

3. Adjust the contrast

Moving the **Contrast** slider to the right increases the contrast, and moving the slider to the left decreases the contrast.

You can also directly enter a value linked to the slider. Enter a value in the range from -50 to 50. The current settings are displayed in the settings preview on the left side of the printer driver.

After adjusting each color, click **OK**.

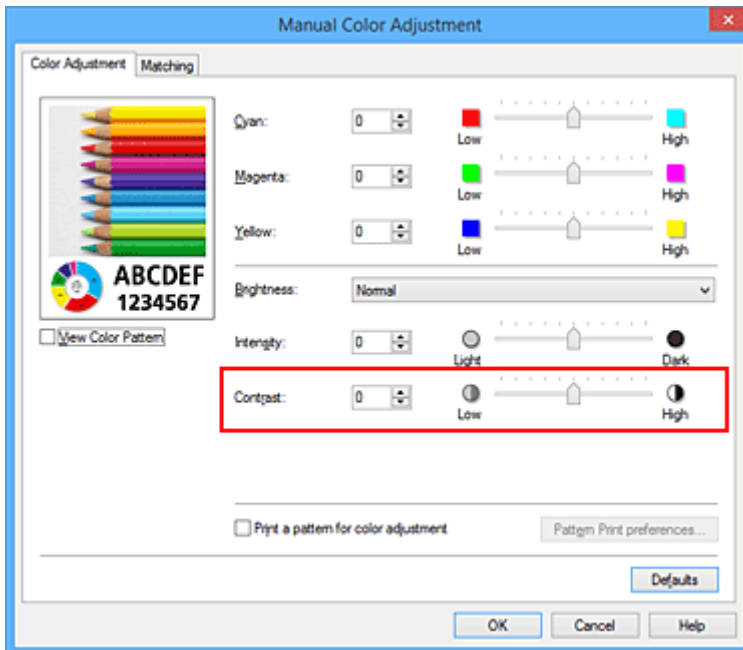

4. Complete the setup

Click **OK** on the **Main** tab.

When you execute print, the image is printed with the adjusted contrast.

Related Topics

- [Specifying Color Correction](#)
- [Adjusting Color Balance](#)
- [Adjusting Color Balance Using Sample Patterns \(Printer Driver\)](#)
- [Adjusting Brightness](#)
- [Adjusting Intensity](#)
- [Adjusting Intensity/Contrast Using Sample Patterns \(Printer Driver\)](#)

Adjusting Intensity/Contrast Using Sample Patterns (Printer Driver)

You can look at the print results of pattern print and adjust the intensity/contrast.

When you change the color balance or intensity/contrast of a document, the pattern print function prints the adjustment results in a list, together with the adjustment values.

Described below is the procedure for adjusting the intensity/contrast while looking at the pattern.

1. Open the [printer driver setup window](#)
2. Select the manual color adjustment

On the **Main** tab, select **Manual** for **Color/Intensity**, and click **Set....**

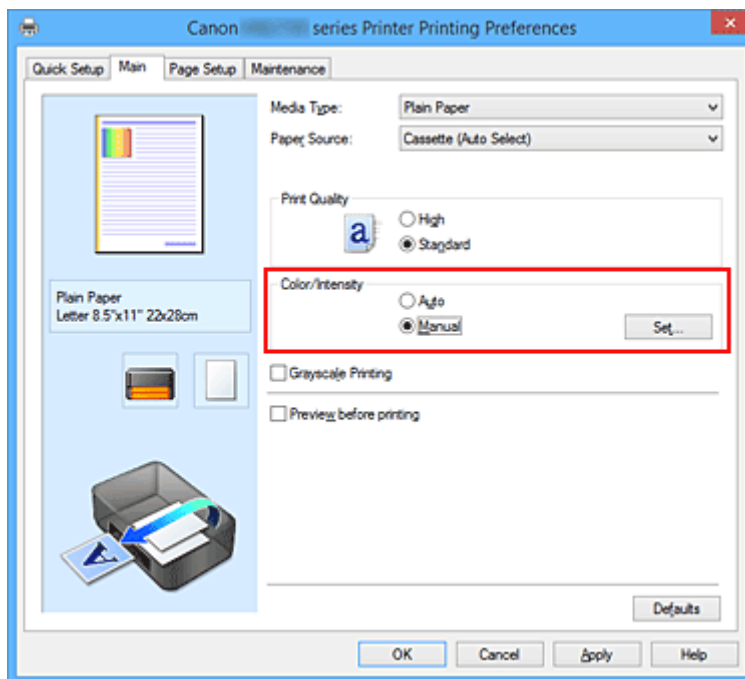

The **Manual Color Adjustment** dialog box opens.

3. Selecting pattern print

On the **Color Adjustment** tab, select the **Print a pattern for color adjustment** check box, and click **Pattern Print preferences....**

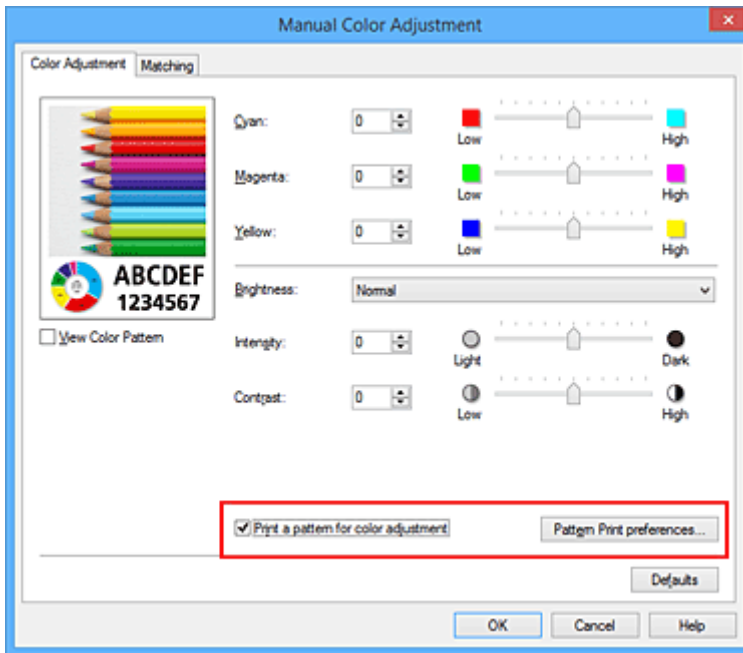

4. Setting pattern print

When the **Pattern Print** dialog box opens, set the following items, and then click **OK**.

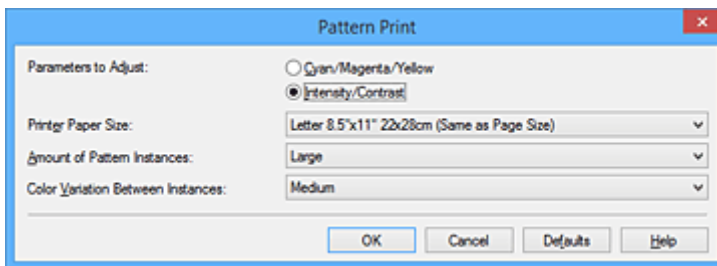

Parameters to Adjust

Select **Intensity/Contrast**.

Printer Paper Size

Select the paper size to be used for pattern printing.

►►► Note

- Depending on the paper size selected on the **Page Setup** tab, there may be sizes that cannot be selected.

Amount of Pattern Instances

Select **Largest**, **Large**, or **Small** to set the number of patterns to be printed.

►►► Note

- **Largest** and **Large** cannot be selected when certain paper sizes or output paper sizes are selected.

Color Variation Between Instances

Set the amount of color change between neighboring patterns.

►►► Note

- **Large** is about double the size of **Medium**, and **Small** is about half the size of **Medium**.

5. Checking the print results of pattern print

On the **Color Adjustment** tab, select **OK** to close the **Manual Color Adjustment** dialog box.

On the **Main** tab, select **OK**, and then execute printing. The printer then prints a pattern in which the intensity/contrast that you set is the center value.

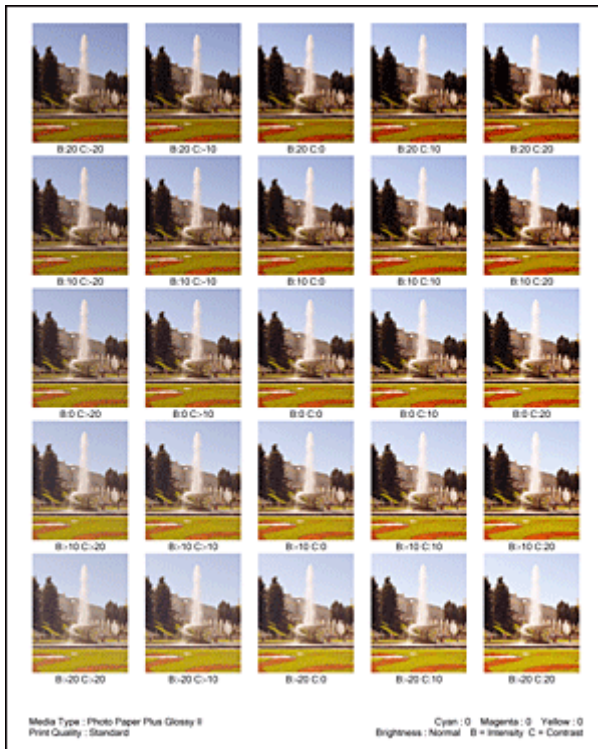

6. Adjusting the intensity/contrast

Look at the print results and select the image that you like best. Then enter the intensity/contrast numbers indicated at the bottom of that image into the **Intensity** and **Contrast** fields on the **Color Adjustment** tab.

Clear the **Print a pattern for color adjustment** check box, and click **OK**.

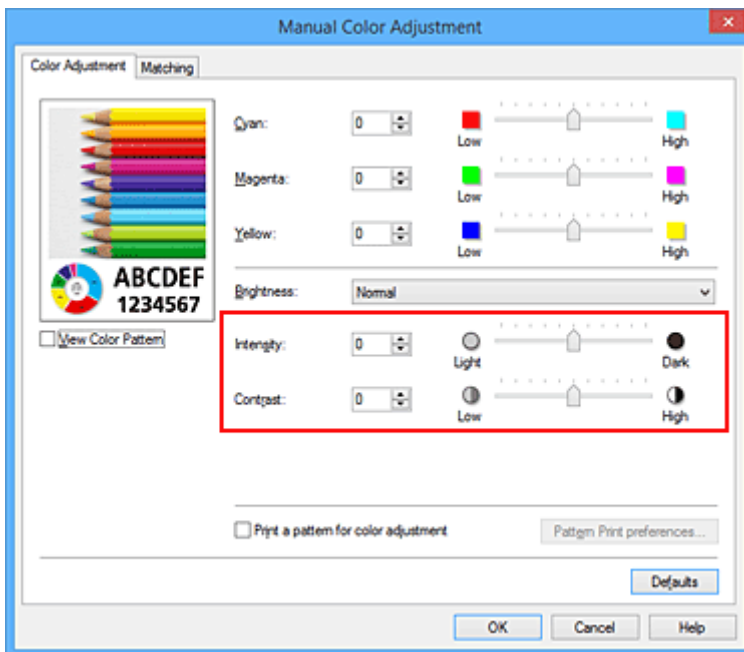

►► Note

- You can also set intensity/contrast on the **Quick Setup** tab by choosing **Photo Printing** under **Commonly Used Settings**, and then choosing **Color/Intensity Manual Adjustment** under **Additional Features**.

7. Complete the setup

Click **OK** on the **Main** tab.

Then when you execute printing, the document is printed with the intensity/contrast that was adjusted by the pattern print function.

►► Important

- When **Print a pattern for color adjustment** is selected on the **Color Adjustment** tab, the following items are grayed out and cannot be set:
 - **Preview before printing** on the **Main** tab
 - **Stapling Side** and **Specify Margin...** on the **Page Setup** tab (When **Duplex Printing** is set, only **Stapling Side** can be set.)
- You can print a pattern only if **Normal-size** is selected for **Page Layout** on the **Page Setup** tab.
- Depending on your application software, this function may not be available.

Related Topics

- [Adjusting Color Balance](#)
- [Adjusting Color Balance Using Sample Patterns \(Printer Driver\)](#)
- [Adjusting Intensity](#)
- [Adjusting Contrast](#)

Overview of the Printer Driver

- ▶ **Canon IJ Printer Driver**
- ▶ **How to Open the Printer Driver Setup Window**
- ▶ **Canon IJ Status Monitor**
- ▶ **Checking the Ink Status from Your Computer**
- ▶ **Canon IJ Preview**
- ▶ **Deleting the Undesired Print Job**
- ▶ **Instructions for Use (Printer Driver)**

Canon IJ Printer Driver

The Canon IJ printer driver (called printer driver below) is a software that is installed on your computer for printing data with this printer.

The printer driver converts the print data created by your application software into data that your printer can understand, and sends the converted data to the printer.

Because different models support different print data formats, you need a printer driver for the specific model you are using.

Printer Driver Types

On Windows Vista SP1 or later, you can install the XPS printer driver in addition to the regular printer driver.

The XPS printer driver is suited to print from an application software that supports XPS printing.

►► Important

- To use the XPS printer driver, the standard printer driver must already be installed on your computer.

Installing the Printer Driver

- To install the regular printer driver, load the Setup CD-ROM that comes with the printer, and then install the driver from **Start Setup Again**.
- To install the XPS printer driver, load the Setup CD-ROM that comes with the printer, and then select **XPS Driver** from **Add Software**.

Specifying the Printer Driver

To specify the printer driver, open the **Print** dialog box of the application software you are using, and select "XXX" (where "XXX" is your model name) to specify the regular printer driver or select "XXX XPS" (where "XXX" is your model name) to specify the XPS printer driver.

Displaying the Manual from the Printer Driver

To display a description of a tab in the printer driver setup window, click the **Help** button found on the tab.

Related Topic

- [How to Open the Printer Driver Setup Window](#)

How to Open the Printer Driver Setup Window

You can display the printer driver setup window from the application software in use or from the printer icon.

Open the Printer Driver Setup Window through the Application Software

Follow the procedure below to configure printing profile when printing.

1. Select the command that you perform printing on the application software

In general, select **Print** on the **File** menu to open the **Print** dialog box.

2. Select your model name and click **Preferences** (or **Properties**)

The printer driver setup window appears.

Note

- Depending on application software you use, command names or menu names may vary and there may be more steps. For details, refer to the user's manual of your application software.

Opening the Printer Driver Setup Window from the Printer Icon

Follow the procedure below to perform printer maintenance operations such as print head cleaning, or to configure a printing profile that is common to all application software.

1. Select as described below:

- If you are using Windows 10, Windows 8.1 or Windows 8, select **Control Panel** -> **Hardware and Sound** -> **Devices and Printers**.
- If you are using Windows 7, select the **Start** menu -> **Devices and Printers**.
- If you are using Windows Vista, select the **Control Panel** -> **Hardware and Sound** -> **Printers**.

2. Right-click your model name icon, and then select **Printing preferences** from the displayed menu

The printer driver setup window appears.

Important

- Opening the printer driver setup window through **Printer properties** (Windows 10, Windows 8.1, Windows 8, Windows 7) or **Properties** (Windows Vista) displays such tabs regarding the Windows functions as the **Ports** (or **Advanced**) tab. Those tabs do not appear when opening through **Printing preferences** or application software. For tabs regarding Windows functions, refer to the user's manual for the Windows.

Canon IJ Status Monitor

The Canon IJ Status Monitor is an application software that shows the status of the printer and the progress of printing. You will know the status of the printer with graphics, icons, and messages.

Launching the Canon IJ Status Monitor

The Canon IJ Status Monitor launches automatically when print data is sent to the printer. When launched, the Canon IJ Status Monitor appears as a button on the task bar.



Click the button of the status monitor displayed on the task bar. The Canon IJ Status Monitor appears.

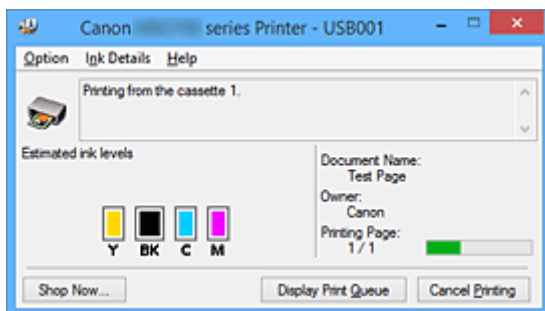

►► Note

- To open the Canon IJ Status Monitor when the printer is not printing, open the [printer driver setup window](#) and click **View Printer Status** on the **Maintenance** tab.
- The information displayed on the Canon IJ Status Monitor may differ depending on the country or region where you are using your printer.

When Errors Occur

The Canon IJ Status Monitor is automatically displayed if an error occurs (e.g., if the printer runs out of paper or if the ink is low).

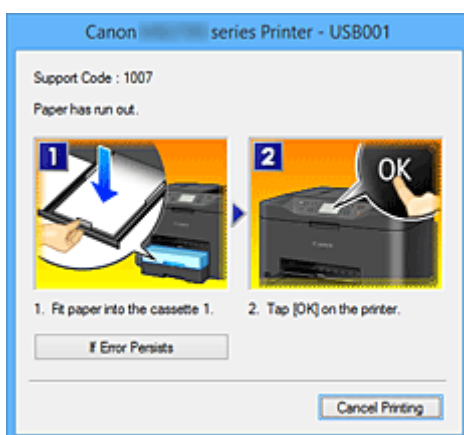

In such cases, take the appropriate action as described.

Checking the Ink Status from Your Computer

You can check the remaining ink level and the ink tank types for your model.

1. Open the [printer driver setup window](#)
2. Launching the Canon IJ Status Monitor

On the **Maintenance** tab, click **View Printer Status**.

The Canon IJ Status Monitor opens and displays an image of the ink status.

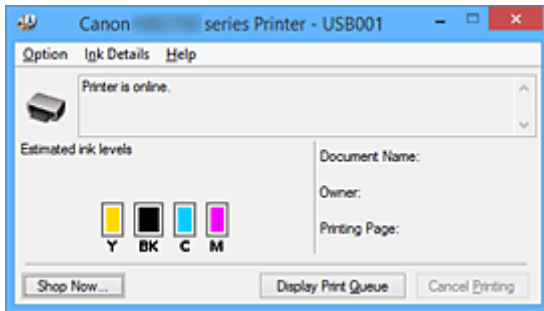

►► Note

- The information displayed on the Canon IJ Status Monitor may differ depending on the country or region where you are using your printer.
- When you receive a notice about the remaining ink level, a mark appears above the ink icon.

For example: 
Ink tank is running low. Prepare a new ink tank.

3. If necessary, click **Ink Details**

You can check the ink-related information.

If a warning or error related to the remaining ink amount occurs, a notification icon is displayed at the top of the image in the **Ink Details** dialog box.

In such cases, take the appropriate action as described on the screen.

►► Note

- You can also display the **Ink Details** dialog box by selecting the ink icon on the Canon IJ Status Monitor.

Canon IJ Preview

The Canon IJ Preview is an application software that displays what the print result will look like before a document is actually printed.

The preview reflects the information that is set within the printer driver and allows you to check the document layout, print order, and number of pages. You can also change the media type and paper source settings.

When you want to display a preview before printing, open the [printer driver setup window](#), click the **Main** tab, and check the **Preview before printing** check box.

When you do not want to display a preview before printing, uncheck the check box.

Important

- If you are using the XPS printer driver, see "[Editing the Print Document or Reprinting from the Print History](#)."

Related Topic

- [Displaying the Print Results before Printing](#)

Deleting the Undesired Print Job

If you are using the XPS printer driver, replace "Canon IJ Status Monitor" with "Canon IJ XPS Status Monitor" when reading this information.

If the printer does not start printing, canceled or failed print job data may be remaining. Delete the undesired print job by using the Canon IJ Status Monitor.

1. Display the Canon IJ Status Monitor

Click the icon of the Canon IJ Status Monitor displayed on the task bar.
The Canon IJ Status Monitor appears.

2. Display the print jobs

Click **Display Print Queue**.
The print queue window opens.

3. Delete the print jobs

Select **Cancel All Documents** from the **Printer** menu.
When the confirmation message appears, click **Yes**.
The deletion of the print job is complete.

▶▶ Important

- Users who have not been granted access permission for printer management cannot delete the print job of another user.

▶▶ Note

- When you perform this operation, all print jobs are deleted. If the print queue list contained a necessary print job, start the printing process over from the beginning.

Instructions for Use (Printer Driver)

This printer driver is subject to the following restrictions. Keep the following points in mind when using the printer driver.

Restrictions on the Printer Driver

- Depending on the document type to be printed, the paper feed method specified in the printer driver may not operate correctly.

If this happens, open the [printer driver setup window](#) from the **Print** dialog box of the application software, and check the setting in the **Paper Source** field on the **Main** tab.

- With some applications, the **Copies** setting in the **Page Setup** tab of the printer driver may not be enabled.

In this case, use the copies setting in the **Print** dialog box of the application software.

- If the selected **Language** in the **About** dialog box of the **Maintenance** tab does not match the operating system interface language, the printer driver setup window may not be displayed properly.
- Do not change the **Advanced** tab items of the printer properties. If you change any of the items, you will not be able to use the following functions correctly.

Also, if **Print to file** is selected in the **Print** dialog box of the application software and with applications that prohibit EMF spooling, such as Adobe Photoshop LE and MS Photo Editor, the following functions will not operate.

- **Preview before printing** on the **Main** tab
 - **Prevention of Print Data Loss** in the **Print Options** dialog box on the **Page Setup** tab
 - **Page Layout, Tiling/Poster, Booklet, Duplex Printing, Specify Margin..., Print from Last Page, Collate, and Stamp/Background... (Stamp...)** on the **Page Setup** tab
 - **Print a pattern for color adjustment** on the **Color Adjustment** tab in the **Manual Color Adjustment** dialog box
- Since the resolution in the preview display differs from the printing resolution, text and lines in the preview display may appear different from the actual print result.
 - With some applications, the printing is divided into multiple print jobs.
To cancel printing, delete all divided print jobs.
 - If image data is not printed correctly, display the **Print Options** dialog box from the **Page Setup** tab and change the setting of **Disable ICM required from the application software**. This may solve the problem.

▶▶▶ Note

- **Disable ICM required from the application software** cannot be used when the XPS printer driver is used.

- Do not start up the Canon IJ Network Tool while printing.
- Do not print when the Canon IJ Network Tool is running.

Points to Note About Applications with Restrictions

- There are following restrictions in Microsoft Word (Microsoft Corporation).
 - When Microsoft Word has the same printing functions as the printer driver, use Word to specify them.

- When **Fit-to-Page**, **Scaled**, or **Page Layout** is used for **Page Layout** on the **Page Setup** tab of the printer driver, the document may not print normally in certain versions of Word.
- When **Page Size** in Word is set to "XXX Enlarge/Reduce", the document may not print normally in certain versions of Word.

If this happens, follow the procedure below.

1. Open Word's **Print** dialog box.
 2. Open the [printer driver setup window](#), and on the **Page Setup** tab, set **Page Size** to the same paper size that you specified in Word.
 3. Set the **Page Layout** that you want, and then click **OK** to close the window.
 4. Without starting printing, close the **Print** dialog box.
 5. Open Word's **Print** dialog box again.
 6. Open the printer driver setup window and click **OK**.
 7. Start printing.
- If bitmap printing is enabled in Adobe Illustrator (Adobe Systems Incorporated), printing may take time or some data may not be printed. Print after unchecking the **Bitmap Printing** check box in the **Print** dialog box.

Printer Driver Description

- ▶ **Quick Setup tab Description**
- ▶ **Main tab Description**
- ▶ **Page Setup tab Description**
- ▶ **Maintenance tab Description**
- ▶ **Canon IJ Preview Description**
- ▶ **Canon IJ XPS Preview Description**
- ▶ **Canon IJ Status Monitor Description**

Quick Setup tab Description

The **Quick Setup** tab is for registering commonly used print settings. When you select a registered setting, the printer automatically switches to the preset items.

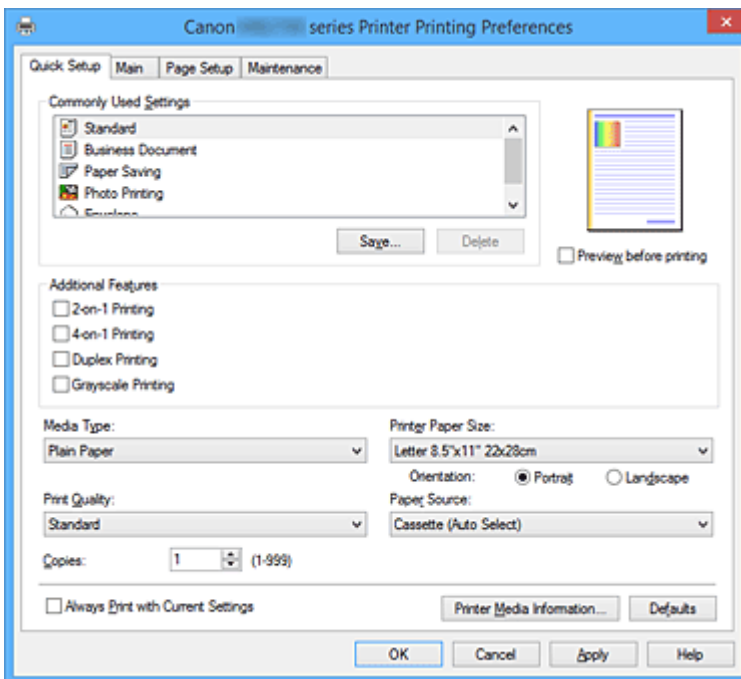

Commonly Used Settings

The names and icons of frequently used printing profiles are registered. When you select a printing profile according to the purpose of the document, settings that match the purpose are applied.

In addition, functions that are thought to be useful for the selected printing profile are displayed in

Additional Features.

You can also change a printing profile and register it under a new name. You can delete the registered printing profile.

You can rearrange the profiles either by dragging the individual profiles or by holding down the Ctrl key and pressing the up or down arrow keys.

Standard

These are the factory settings.

If **Page Size**, **Orientation**, and **Copies** were set from the application software, those settings have priority.

Business Document

Select this setting when printing a general document.

If **Page Size**, **Orientation**, and **Copies** were set from the application software, those settings have priority.

Paper Saving

Select this setting to save paper when printing a general document. The **2-on-1 Printing** and **Duplex Printing** check boxes are checked automatically.

If **Page Size**, **Orientation**, and **Copies** were set from the application software, those settings have priority.

Photo Printing

If you select this setting when printing a photo, the photo paper and photo size generally used are set.

If **Orientation** and **Copies** were set from the application software, those settings have priority.

Envelope

If you select this setting for printing an envelope, **Media Type** is set automatically to **Envelope**. In the **Envelope Size Setting** dialog box, select the size of the envelope to be used.

▶▶▶ Note

- The combination of the **Additional Features** that was displayed for the printing profile that had been selected when the added printing profile was saved is also displayed when that added printing profile is selected.

Save...

Displays the [Save Commonly Used Settings dialog box](#).

Click this button when you want to save the information that you set on the **Quick Setup**, **Main**, and **Page Setup** tabs to **Commonly Used Settings**.

Delete

Deletes a registered printing profile.

Select the name of the setting to be deleted from **Commonly Used Settings**, and click **Delete**. When a confirmation message is displayed, click **OK** to delete the specified printing profile.

▶▶▶ Note

- Printing profiles that are registered in the initial settings cannot be deleted.

Settings Preview

The paper illustration shows how the original will be laid out on a sheet of paper.

You can check an overall image of the layout.

Preview before printing

Shows what the print result will look like before you actually print the data.

Check this check box to display a preview before printing.

Uncheck this check box if you do not want to display a preview.

▶▶▶ Important

- To use the Canon IJ XPS Preview, you must have Microsoft .NET Framework 4 Client Profile installed on your computer.

Additional Features

Displays the frequently used, convenient functions for the printing profile that you selected for **Commonly Used Settings** on the **Quick Setup** tab.

When you move the mouse pointer near a function that can be changed, a description of that function is displayed.

To enable a function, check the corresponding check box.

For some functions, you can set detailed settings from the **Main** and **Page Setup** tabs.

▶▶▶ Important

- Depending on the printing profiles, certain function may be grayed out and you will not be able to change them.

2-on-1 Printing

Prints two pages of the document, side by side, on one sheet of paper.

To change the page sequence, click the **Page Setup** tab, select **Page Layout** for **Page Layout**, and click **Specify...** Then in the [Page Layout Printing dialog box](#) that appears, specify the **Page Order**.

4-on-1 Printing

Prints four pages of the document, side by side, on one sheet of paper.

To change the page sequence, click the **Page Setup** tab, select **Page Layout** for **Page Layout**, and click **Specify...** Then in the [Page Layout Printing dialog box](#) that appears, specify the **Page Order**.

Duplex Printing

Selects whether to print the document on both sides or one side of a sheet of paper.

To change the staple side or the margins, set the new values from the **Page Setup** tab.

Grayscale Printing

This function converts the data to monochrome data when printing your document.

Rotate 180 degrees

Prints the document by rotating it 180 degrees against the paper feed direction.

The width of print area and the amount of extension that are configured in other application software will be reversed vertically and horizontally.

Color/Intensity Manual Adjustment

Select when you set the **Color Correction** method and individual settings such as **Cyan**, **Magenta**, **Yellow**, **Brightness**, **Intensity**, and **Contrast**, etc.

Media Type

Selects a type of printing paper.

Select a media type that matches the paper that is loaded in the printer. This ensures that printing is carried out properly for the specified paper.

Printer Paper Size

Selects the size of paper actually loaded into the printer.

Normally, the paper size is set automatically according to the output paper size setting, and the document is printed with no scaling.

When you set **2-on-1 Printing** or **4-on-1 Printing** in **Additional Features**, you can manually set the paper size with **Page Size** on the **Page Setup** tab.

If you select a paper size that is smaller than the **Page Size**, the document size will be reduced. If you select a paper size that is larger, the document size will be enlarged.

Also if you select **Custom...**, the [Custom Paper Size dialog box](#) opens and allows you to specify any vertical and horizontal dimensions for the paper size.

Orientation

Selects the printing orientation.

If the application used to create your document has a similar function, select the same orientation that you selected in that application.

Portrait

Prints the document so that its top and bottom positions are unchanged relative to the paper feed direction. This is the default setting.

Landscape

Prints the document by rotating it 90 degrees relative to the paper feed direction.

You can change the rotation direction by going to the **Maintenance** tab, opening the **Custom Settings** dialog box, and then using **Rotate 90 degrees left when orientation is [Landscape]** check box.

To rotate the document 90 degrees to the left when printing, select the **Rotate 90 degrees left when orientation is [Landscape]** check box.

Print Quality

Selects your desired printing quality.

Select one of the following to set the print quality level that is appropriate for the purpose.

High

Gives priority to print quality over printing speed.

Standard

Prints with average speed and quality.

Paper Source

Select the source from which paper is supplied.

Cassette (Auto Select)

Based on the paper settings on the printer driver and the cassette paper information registered on the printer, the printer automatically determines which cassette to use and feeds paper from that cassette.

Cassette 1

Paper is fed from the cassette 1.

Cassette 2

Paper is fed from the cassette 2.

»» Important

- Depending on the media type and size, the **Paper Source** settings that can be selected may differ.

Copies

Specifies the number of copies you want to print. You can specify a value from 1 to 999.

»» Important

- When the application software that you used to create the document has the same function, specify the settings on the printer driver. However, if the print results are not acceptable, specify the function settings on the application software.

Always Print with Current Settings

Prints documents with the current settings starting from the next print execution.

When you select this function and then close the [printer driver setup window](#), the information that you set on the **Quick Setup**, **Main**, and **Page Setup** tabs are saved and printing with the same settings is possible starting from the next print execution.

»» Important

- If you log on with a different user name, the settings that were set when this function was enabled are not reflected in the print settings.
- If a setting was specified on the application software, it has priority.

Printer Media Information...

Displays [Printer Media Information dialog box](#).

You can check the printer settings and apply the checked settings to the printer driver.

Defaults

Restores all the settings you have changed to their default values.

Click this button to return all settings on the **Quick Setup**, **Main**, and **Page Setup** tabs to their default values (factory settings).

Save Commonly Used Settings dialog box

This dialog box allows you to save the information that you set on the **Quick Setup**, **Main**, and **Page Setup** tabs and add the information to the **Commonly Used Settings** list on the **Quick Setup** tab.

Name

Enter the name for the printing profile you wish to save.

Up to 255 characters can be entered.

The name appears, with its associated icon, in the **Commonly Used Settings** list on the **Quick Setup** tab.

Options...

Opens the [Save Commonly Used Settings dialog box](#).

Changes the details of printing profile to be saved.

Save Commonly Used Settings dialog box

Select the icons of the printing profiles to be registered to **Commonly Used Settings**, and change the items to be saved in the printing profiles.

Icon

Select the icon for the printing profile you wish to save.

The selected icon appears, with its name, in the **Commonly Used Settings** list on the **Quick Setup** tab.

Save the paper size setting

Saves the paper size to the printing profile in **Commonly Used Settings**.

To apply the saved paper size when the printing profile is selected, check this check box.

If this check box is unchecked, the paper size is not saved, and consequently the paper size setting is not applied when the printing profile is selected. Instead the printer prints with the paper size specified with the application software.

Save the orientation setting

Saves the **Orientation** to the printing profile in **Commonly Used Settings**.

To apply the saved print orientation when the printing profile is selected, check this check box.

If this check box is unchecked, the print orientation is not saved, and consequently the **Orientation** setting is not applied when the printing profile is selected. Instead the printer prints with the print orientation specified with the application software.

Save the copies setting

Saves the **Copies** setting to the printing profile in **Commonly Used Settings**.

To apply the saved copies setting when the printing profile is selected, check this check box.

If this check box is unchecked, the copies setting is not saved, and consequently the **Copies**

setting is not applied when the printing profile is selected. Instead the printer prints with the copies setting specified with the application software.

Custom Paper Size dialog box

This dialog box allows you to specify the size (width and height) of the custom paper.

Units

Select the unit for entering a user-defined paper size.

Paper Size

Specifies the **Width** and the **Height** of the custom paper. Measurement is shown according to the units specified in **Units**.

Printer Media Information dialog box

This dialog box allows you to check the printer settings and apply the checked settings to the printer driver.

Paper Source

Check the setting or select a new paper source.

Media Type

Displays the **Media Type** that is currently set on the printer.

To apply the displayed setting to the printer driver, click **Set**.

Page Size

Displays the **Page Size** that is currently set on the printer.

To apply the displayed setting to the printer driver, click **Set**.

Related Topics

- [Printing with Easy Setup](#)
- [Setting a Page Size and Orientation](#)
- [Setting the Number of Copies and Printing Order](#)
- [Duplex Printing](#)
- [Setting Up Envelope Printing](#)
- [Printing on Postcards](#)
- [Switching the Paper Source to Match the Purpose](#)
- [Displaying the Print Results before Printing](#)
- [Setting Paper Dimensions \(Custom Size\)](#)
- [Printing a Color Document in Monochrome](#)
- [Specifying Color Correction](#)
- [Adjusting Color Balance](#)
- [Adjusting Color Balance Using Sample Patterns \(Printer Driver\)](#)
- [Adjusting Brightness](#)
- [Adjusting Intensity](#)
- [Adjusting Contrast](#)
- [Adjusting Intensity/Contrast Using Sample Patterns \(Printer Driver\)](#)
- [Registering a Frequently Used Printing Profile](#)

Main tab Description

The **Main** tab allows you to create a basic print setup in accordance with the media type. Unless special printing is required, normal printing can be performed just by setting the items on this tab.

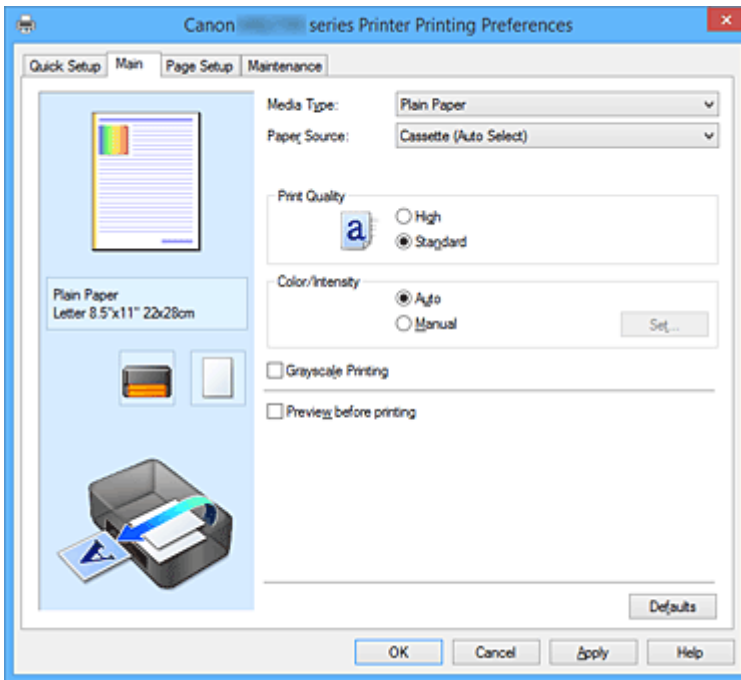

Settings Preview

The paper illustration shows how the original will be laid out on a sheet of paper.

You can check an overall image of the layout.

The printer illustration shows how to load paper to match the printer driver settings.

Check whether the printer is set up correctly by looking at the illustration before you start printing.

Media Type

Selects a type of printing paper.

Select a media type that matches the paper that is loaded in the printer. This ensures that printing is carried out properly for the specified paper.

Paper Source

Shows the source from which paper is supplied.

You may be able to switch the paper source with the printer driver.

Cassette (Auto Select)

Based on the paper settings on the printer driver and the cassette paper information registered on the printer, the printer automatically determines which cassette to use and feeds paper from that cassette.

Cassette 1

Paper is fed from the cassette 1.

Cassette 2

Paper is fed from the cassette 2.

►►► Important

- Depending on the media type and size, the **Paper Source** settings that can be selected may differ.

Print Quality

Selects your desired printing quality.

Select one of the following to set the print quality level that is appropriate for the purpose.

»» Important

- Depending on the **Media Type** settings, the same print results may be produced even if the **Print Quality** is changed.

High

Gives priority to print quality over printing speed.

Standard

Prints with average speed and quality.

Color/Intensity

Selects color adjustment method.

Auto

Cyan, Magenta, Yellow, Brightness, Intensity, and Contrast, and so on are adjusted automatically.

Manual

Select when you set the individual settings such as **Cyan, Magenta, Yellow, Brightness, Intensity, and Contrast**, etc. and **Color Correction** method.

Set...

Select **Manual** for **Color/Intensity** to enable this button.

In the **Manual Color Adjustment** dialog box, you can adjust individual color settings such as **Cyan, Magenta, Yellow, Brightness, Intensity, and Contrast** on the [Color Adjustment tab](#), and select the **Color Correction** method on the [Matching tab](#).

»» Note

- If you want to use an ICC profile to adjust colors, use the **Manual Color Adjustment** dialog box to set the profile.

Grayscale Printing

This function converts the data to monochrome data when printing your document.

Check this check box to print a color document in monochrome.

Preview before printing

Shows what the print result will look like before you actually print the data.

Check this check box to display a preview before printing.

»» Important

- To use the Canon IJ XPS Preview, you must have Microsoft .NET Framework 4 Client Profile installed on your computer.

Defaults

Restores all the settings you have changed to their default values.

Clicking this button restores all the settings on the current screen to their default values (factory settings).

Color Adjustment Tab

This tab allows you to adjust the color balance by changing the settings of the **Cyan, Magenta, Yellow, Brightness, Intensity**, and **Contrast** options.

Preview

Shows the effect of color adjustment.

The color and brightness change when each item is adjusted.

Note

- The graphic is in monochrome when the **Grayscale Printing** check box is checked.

View Color Pattern

Displays a pattern for checking color changes produced by color adjustment.

If you want to display the preview image with a color pattern, check this check box.

Cyan / Magenta / Yellow

Adjusts the strengths of **Cyan, Magenta**, and **Yellow**.

Moving the slider to the right makes a color stronger, and moving the slider to the left makes a color weaker.

You can also directly enter a value linked to the slider. Enter a value in the range from -50 to 50.

This adjustment changes the relative amount of ink of each color used, which alters the total color balance of the document. Use your application if you want to change the total color balance significantly. Use the printer driver only if you want to adjust the color balance slightly.

Important

- When **Grayscale Printing** is checked on the **Main** tab, **Cyan, Magenta**, and **Yellow** appear grayed out and are unavailable.

Brightness

Selects the brightness of your print.

You cannot change the levels of pure white and black. However, the brightness of the colors between white and black can be changed.

Intensity

Adjusts the overall intensity of your print.

Moving the slider to the right increases the intensity, and moving the slider to the left decreases the intensity.

You can also directly enter a value linked to the slider. Enter a value in the range from -50 to 50.

Contrast

Adjusts the contrast between light and dark in the image to be printed.

Moving the slider to the right increases the contrast, moving the slider to the left decreases the contrast.

You can also directly enter a value linked to the slider. Enter a value in the range from -50 to 50.

Print a pattern for color adjustment

When the color balance or intensity/contrast is changed, the pattern printing function prints a list of the adjustment results along with the adjustment values.

Select this function when printing a pattern for color adjustment.

Pattern Print preferences...

Check **Print a pattern for color adjustment** to enable this button.

The [Pattern Print dialog box](#) opens and allows you to set pattern printing settings.

Pattern Print dialog box

Performs the setup for printing of patterns that allow you to check the color balance and intensity/contrast of documents.

Parameters to Adjust

Select the item to be checked by pattern printing.

Cyan/Magenta/Yellow

Prints a pattern that allows you to check the cyan/magenta/yellow balance.

▶▶▶ Important

- When **Grayscale Printing** is checked on the **Main** tab, **Cyan/Magenta/Yellow** appear grayed out and are unavailable.

Intensity/Contrast

Prints a pattern that allows you to check the intensity/contrast balance.

Printer Paper Size

Selects the paper size to be used for pattern printing.

This setting is linked to **Printer Paper Size** on the **Page Setup** tab.

▶▶▶ Note

- Depending on the paper size selected on the **Page Setup** tab, there may be sizes that cannot be selected.

Amount of Pattern Instances

Sets the number of patterns to be printed.

You can select from **Largest**, **Large**, and **Small**. When you select a pattern size, the number of patterns that can be printed is as follows:

▶▶▶ Note

- **Largest** and **Large** cannot be selected when certain paper sizes or output paper sizes are selected.
- The setting preview on the **Main** tab displays an image that allows you to check the overall layout.

Largest

Cyan/Magenta/Yellow 37

Intensity/Contrast 49

Large

Cyan/Magenta/Yellow 19

Intensity/Contrast 25

Small

Cyan/Magenta/Yellow 7

Intensity/Contrast 9

Color Variation Between Instances

Sets the amount of color change between neighboring patterns.

Select from **Large**, **Medium**, and **Small**. **Large** produces a large amount of change, and **Small** produces a small amount of change.

▶▶▶ Note

- **Large** is about double the size of **Medium**, and **Small** is about half the size of **Medium**.

Matching Tab

Allows you to select the method for adjusting colors to match the type of document to be printed.

Color Correction

Allows you to select **Driver Matching**, **ICM (ICC Profile Matching)**, or **None** to match the purpose of the print operation.

▶▶▶ Important

- When **Grayscale Printing** is checked on the **Main** tab, **Color Correction** appears grayed out and is unavailable.

Driver Matching

With Canon Digital Photo Color, you can print sRGB data with color tints that most people prefer.

ICM (ICC Profile Matching)

Adjusts the colors by using an ICC profile when printing.

▶▶▶ Important

- If the application software is set so that ICM is disabled, **ICM (ICC Profile Matching)** is unavailable for **Color Correction** and the printer may not be able to print the image data properly.

None

Disables color adjustment with the printer driver.

▶▶▶ Note

- In the XPS printer driver, **ICM** has become **ICC Profile Matching**.

Related Topics

- [Adjusting Color Balance](#)
- [Adjusting Brightness](#)
- [Adjusting Intensity](#)
- [Adjusting Contrast](#)
- [Adjusting Color Balance Using Sample Patterns \(Printer Driver\)](#)
- [Adjusting Intensity/Contrast Using Sample Patterns \(Printer Driver\)](#)
- [Specifying Color Correction](#)
- [Adjusting Colors with the Printer Driver](#)
- [Printing with ICC Profiles](#)
- [Printing a Color Document in Monochrome](#)
- [Displaying the Print Results before Printing](#)

Page Setup tab Description

The **Page Setup** tab allows you to determine how a document is to be arranged on the paper. Also, this tab allows you to set the number of copies and the order of printing. If the application which created the document has a similar function, set them with the application.

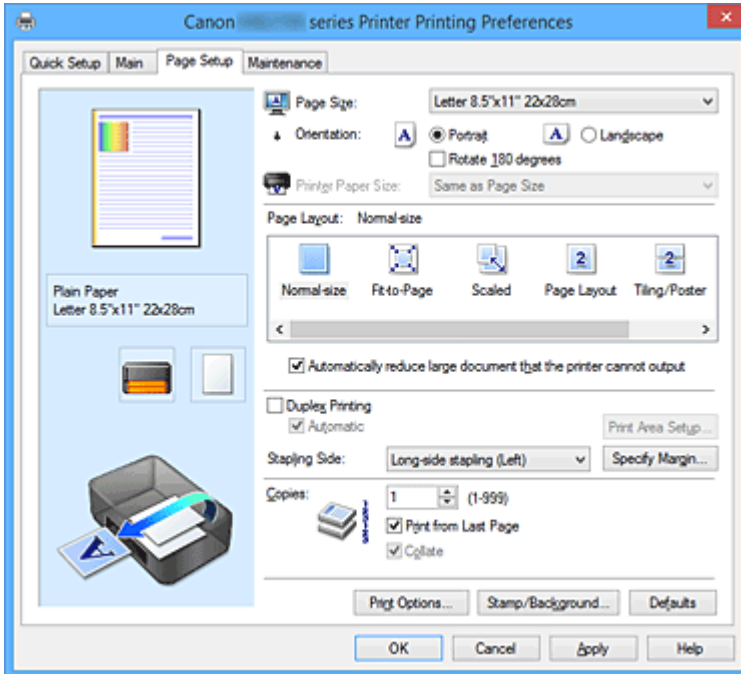

Settings Preview

The paper illustration shows how the original will be laid out on a sheet of paper.

You can check an overall image of the layout.

The printer illustration shows how to load paper to match the printer driver settings.

Check whether the printer is set up correctly by looking at the illustration before you start printing.

Page Size

Selects a page size.

Ensure that you select the same page size as you selected within the application.

If you select **Custom...**, the [Custom Paper Size dialog box](#) opens and allows you to specify any vertical and horizontal dimensions for the paper size.

Orientation

Selects the printing orientation.

If the application used to create your document has a similar function, select the same orientation that you selected in that application.

Portrait

Prints the document so that its top and bottom positions are unchanged relative to the paper feed direction. This is the default setting.

Landscape

Prints the document by rotating it 90 degrees relative to the paper feed direction.

You can change the rotation direction by going to the **Maintenance** tab, opening the **Custom Settings** dialog box, and then using **Rotate 90 degrees left when orientation is [Landscape]** check box.

To rotate the document 90 degrees to the left when printing, select the **Rotate 90 degrees left when orientation is [Landscape]** check box.

Rotate 180 degrees

Prints the document by rotating it 180 degrees against the paper feed direction.

The width of print area and the amount of extension that are configured in other application software will be reversed vertically and horizontally.

Printer Paper Size

Selects the size of paper actually loaded into the printer.

The default setting is **Same as Page Size** to perform normal-sized printing.

You can select a printer paper size when you select **Fit-to-Page**, **Scaled**, **Page Layout**, **Tiling/Poster**, or **Booklet** for **Page Layout**.

If you select a paper size that is smaller than the **Page Size**, the document size will be reduced. If you select a paper size that is larger, the document size will be enlarged.

Also if you select **Custom...**, the [Custom Paper Size dialog box](#) opens and allows you to specify any vertical and horizontal dimensions for the paper size.

Page Layout

Selects the size of the document you want to print and the type of printing.

Normal-size

This is the normal printing method. Select this when you do not specify any page layout.

Automatically reduce large document that the printer cannot output

If the printer cannot print the paper size of a document, the printer can automatically reduce the size when it prints the document.

Check this check box to reduce the size when printing the document.

Fit-to-Page

This function enables you to automatically enlarge or reduce documents to fit to the paper size loaded in the printer without changing the paper size you specified in your application software.

Scaled

Documents can be enlarged or reduced to be printed.

Specify the size in **Printer Paper Size**, or enter the scaling ratio in the **Scaling** box.

Scaling

Specifies an enlargement or reduction ratio for the document you want to print.

Page Layout

Multiple pages of document can be printed on one sheet of paper.

Specify...

Opens the [Page Layout Printing dialog box](#).

Click this button to set details on page layout printing.

Tiling/Poster

This function enables you to enlarge the image data and divide the enlarged data into several pages to be printed. You can also glue together these sheets of paper to create large printed matter, such as a poster.

Specify...

Opens the [Tiling/Poster Printing dialog box](#).

Click this button to set details on tiling/poster printing.

Booklet

The booklet printing function allows you to print data for a booklet. Data is printed on both sides of the paper. This type of printing ensures that pages can be collated properly, in page number order, when the printed sheets are folded and stapled at the center.

Specify...

Opens the [Booklet Printing dialog box](#).

Click this button to set details on booklet printing.

Duplex Printing

Selects whether to print the document automatically on both sides or one side of a sheet of paper.

Check this check box to print the document on both sides.

This function can be used only when **Plain Paper** is selected for **Media Type** and one of **Normal-size**, **Fit-to-Page**, **Scaled**, or **Page Layout** is selected.

Automatic

Selects whether duplex printing is to be performed automatically or manually.

This check box will be enabled if **Booklet** is selected from the **Page Layout** list or the **Duplex Printing** check box is checked.

To perform duplex printing automatically, check this check box.

To perform duplex printing manually, uncheck this check box.

Print Area Setup...

Opens the [Print Area Setup dialog box](#) in which you can configure the print area for automatic duplex printing.

Stapling Side

Selects the stapling margin position.

The printer analyzes the **Orientation** and **Page Layout** settings, and automatically selects the best stapling margin position. Check **Stapling Side**, and select from the list to change it.

Specify Margin...

Opens the [Specify Margin dialog box](#).

You can specify the width of the margin.

Copies

Specifies the number of copies you want to print. You can specify a value from 1 to 999.

►► Important

- If the application used to create your document has a similar function, specify the number of copies with the application without specifying it here.

Print from Last Page

Check this check box when you want to print from the last page in order. If you do this, you do not need to sort the pages into their correct order after printing.

Uncheck this check box to print your document in normal order, starting from the first page.

Collate

Check this check box to group together the pages of each copy when you want to print multiple copies.

Uncheck this check box when you want to print with all pages of the same page number grouped together.

»» Important

- When the application software that you used to create the document has the same function, give priority to the printer driver settings. However, if the print results are not acceptable, specify the function settings on the application software. When you specify the number of copies and the printing order with both the application and this printer driver, the number of copies may be multiplied numbers of the two settings or the specified printing order may not be enabled.

Print Options...

Opens the [Print Options dialog box](#).

Changes detailed printer driver settings for print data that is sent from applications.

Stamp/Background... (Stamp...)

Opens the [Stamp/Background \(Stamp\) dialog box](#).

The **Stamp** function allows you to print a stamp text or a bitmap over or behind document data. It also allows you to print date, time and user name. The **Background** function allows you to print a light illustration behind the document data.

»» Note

- With the XPS printer driver, the **Stamp/Background...** button has become the **Stamp...** button and only the stamp function can be used.

Depending on the type of printer driver you are using and the environment, **Stamp** and **Background** may not be available.

Custom Paper Size dialog box

This dialog box allows you to specify the size (width and height) of the custom paper.

Units

Select the unit for entering a user-defined paper size.

Paper Size

Specifies the **Width** and the **Height** of the custom paper. Measurement is shown according to the units specified in **Units**.

Page Layout Printing dialog box

This dialog box allows you to select the number of document pages to be placed on one sheet of paper, the page order, and whether a page border line is to be printed around each document page.

The settings specified in this dialog box can be confirmed in the settings preview on the printer driver.

Preview Icon

Shows the settings made on the **Page Layout Printing** dialog box.

You can check what the print result will look like before you actually print the data.

Page Layout

Specifies the number of document pages to fit on one sheet.

Page Order

Specifies the document orientation to be printed on a sheet of paper.

Page Border

Prints a page border line around each document page.
Check this check box to print the page border line.

Tiling/Poster Printing dialog box

This dialog box allows you to select the size of the image to be printed. You can also make settings for cut lines and paste markers which are convenient for pasting together the pages into a poster. The settings specified in this dialog box can be confirmed in the settings preview on the printer driver.

Preview Icon

Shows the settings of the **Tiling/Poster Printing** dialog box.
You can check what the print result will look like.

Image Divisions

Select the number of divisions (vertical x horizontal).
As the number of divisions increases, the number of sheets used for printing increases. If you are pasting pages together to create a poster, increasing the number of divisions allows you to create a larger poster.

Print "Cut/Paste" in margins

Specifies whether to print the words "Cut" and "Paste" in the margins. These words serve as guidelines for pasting together the pages into a poster.
Check this check box to print the words.

►►► Note

- Depending on the type of printer driver you are using and the environment, this function may not be available.

Print "Cut/Paste" lines in margins

Specifies whether to print cut lines that serve as guidelines for pasting together the pages into a poster.
Check this check box to print the cut lines.

Print page range

Specifies the printing range. Select **All** under normal circumstances.
Select **Pages** to specify a specific page or range.

►►► Note

- If some of the pages have not been printed well, specify the pages that do not need to be printed by clicking them in the settings preview of the **Page Setup** tab. Only the pages shown on the screen will be printed this time.

Booklet Printing dialog box

This dialog box allows you to set how to bind the document as a booklet. Printing only on one side and printing a page border, can also be set in this dialog box.
The settings specified in this dialog box can be confirmed in the settings preview on the printer driver.

Preview Icon

Shows the settings made on the **Booklet Printing** dialog box.
You can check what the document will look like when printed as a booklet.

Margin for stapling

Specifies which side of the booklet is to be stapled.

Insert blank page

Selects whether to print the document on one side or both sides of the booklet.
Check this check box to print the document on one side of the booklet and select the side to be left blank from the list.

Margin

Specifies the width of the stapling margin.
The specified width becomes the stapling margin from the center of the sheet.

Page Border

Prints a page border line around each document page.
Check this check box to print the page border line.

Print Area Setup dialog box

When you perform duplex printing, the print area of the document becomes slightly narrower than usual. Therefore when a document that has small margins is printed, the document may not fit on one page. This dialog box allows you to set whether the page is to be reduced when printed so that the document fits in one page.

Use normal-size printing

Prints the document pages without reducing them. This is the default setting.

Use reduced printing

Slightly reduces each document page so that it fits on one sheet of paper during printing.
Select this setting when using automatic duplex printing to print a document with small margins.

Specify Margin dialog box

This dialog box allows you to specify the margin width for the side to be stapled. If a document does not fit on one page, the document is reduced when printed.

Margin

Specifies the width of the stapling margin.
The width of the side specified by **Stapling Side** becomes the stapling margin.

Print Options dialog box

Makes changes to print data that is sent to the printer.

Depending on the type of printer driver you are using and the environment, this function may not be available.

Disable ICM required from the application software

Disables the ICM function required from the application software.
When an application software uses Windows ICM to print data, unexpected colors may be produced

or the printing speed may decrease. If these problems occur, checking this check box may resolve the problems.

▶▶▶ Important

- Uncheck this check box under normal circumstances.
- This function does not work when **ICM** is selected for **Color Correction** on the **Matching** tab of the **Manual Color Adjustment** dialog box.

▶▶▶ Note

- **Disable ICM required from the application software** tab cannot be used with the XPS printer driver.

Disable the color profile setting of the application software

Checking this check box disables information in the color profile that was set on the application software.

When the information in the color profile set on the application software is output to the printer driver, the print result may contain unexpected colors. If this happens, checking this check box may resolve the problem.

▶▶▶ Important

- Even when this check box is checked, only some of the information in the color profile is disabled, and the color profile can still be used for printing.
- Uncheck this check box under normal circumstances.

Disable the paper source setting of the application software

Disables the paper feeding method that is set by the application.

With some applications such as Microsoft Word, the data may be printed with a feeding method that differs from the printer driver setting. In this case, check this function.

▶▶▶ Important

- When this function is enabled, normally the paper feeding method cannot be changed from the Canon IJ Preview.
However, if you are using the XPS printer driver, you will be able to change the paper feeding method from the Canon IJ XPS Preview.

Ungroup Papers

Sets the display method of **Media Type**, **Page Size**, and **Printer Paper Size**.

To display the items separately, select the check box.

To display the items as a group, clear the check box.

Do not allow application software to compress print data

Compression of the application software print data is prohibited.

If the print result has missing image data or unintended colors, selecting this check box may improve the condition.

▶▶▶ Important

- Uncheck this check box under normal circumstances.

»» Note

- **Do not allow application software to compress print data** tab cannot be used with the XPS printer driver.

Print after creating print data by page

The print data is created in page units, and printing starts after the processing of one page of print data is complete.

If a printed document contains unintended results such as streaks, selecting this check box may improve the results.

»» Important

- Uncheck this check box under normal circumstances.

Scale images using nearest-neighbor interpolation

When an image is to be enlarged or reduced when printed, the printer uses a simple interpolation process to enlarge or reduce the image.

If the image data in a printed document is not printed clearly, selecting this check box may improve the results.

»» Important

- Uncheck this check box under normal circumstances.

»» Note

- **Scale images using nearest-neighbor interpolation** can be used only with the XPS printer driver.

Prevention of Print Data Loss

You can reduce the size of the print data that was created with the application software and then print the data.

Depending on the application software being used, the image data may be cut off or may not be printed properly. In such cases, select **On**. If you will not be using this function, select **Off**.

»» Important

- When using this function, the print quality may drop depending on the print data.

Unit of Print Data Processing

Selects the processing unit of the print data to be sent to the printer.

Select **Recommended** under normal circumstances.

»» Important

- A large amount of memory may be used for certain settings.
Do not change the setting if your computer has a small amount of memory.

»» Note

- **Unit of Print Data Processing** tab cannot be used with the XPS printer driver.

Stamp/Background (Stamp...) dialog box

The **Stamp/Background (Stamp...)** dialog box allows you to print a stamp and/or background over or behind the document pages. In addition to the pre-registered ones, you can register and use your original stamp or background.

»» Note

- With the XPS printer driver, the **Stamp/Background...** button has become the **Stamp...** button and only the stamp function can be used.

Stamp

Stamp printing is a function that prints a stamp over a document.

Check this check box and select a title from the list to print a stamp.

Define Stamp...

Opens the [Stamp Settings dialog box](#).

You can check the details of a selected stamp or save a new stamp.

Place stamp over text

Sets how the stamp is to be printed over the document.

Check the **Stamp** check box to enable this.

Check this check box to print a stamp over the printed document page. The printed data may be hidden behind the stamp.

Uncheck this check box to print the document data over the stamp. The printed data will not be hidden behind the stamp. However, the sections of the stamp that are overlapped by the document may be hidden.

Print semitransparent stamp

Sets how the stamp is to be printed over the document.

Check the **Stamp** check box to enable this.

Check this check box to print a semi-transparent stamp over the printed document page.

Uncheck this check box to print the stamp over the document data. The printed data may be hidden behind the stamp.

»» Note

- You can use **Print semitransparent stamp** only with the XPS printer driver.

Stamp first page only

Selects whether the stamp is to be printed on the first page only or on all pages when the document has two or more pages.

Check the **Stamp** check box to enable this.

Check this check box to print a stamp on the first page only.

Background

Background printing is a function that allows you to print an illustration or a similar object (bitmap) behind the document.

Check this check box to print a background and select a title from the list.

Select Background...

Opens the [Background Settings dialog box](#).

You can register a bitmap as a background, and change layout method and intensity of the selected background.

Background first page only

Selects whether to print the background on the first page only or print on all pages when the document has two or more pages.

Check the **Background** check box to enable this.

Check this check box to print a background on the first page only.

Stamp Tab

The Stamp tab allows you to set the text and bitmap file (.bmp) to be used for a stamp.

Preview Window

Shows the status of the stamp configured in each tab.

Stamp Type

Specifies the stamp type.

Select **Text** to create a stamp with characters. Select **Bitmap** to create with a bitmap file. Select **Date/Time/User Name** to display the creation date/time and user name of the printed document.

The setting items in the **Stamp** tab change depending on the selected type.

When Stamp Type is Text or Date/Time/User Name

Stamp Text

Specifies the stamp text string.

Up to 64 characters can be entered.

For **Date/Time/User Name**, the creation date/time and user name of the printed object are displayed in **Stamp Text**.

▶▶▶ Important

- **Stamp Text** appears grayed out and is unavailable if **Date/Time/User Name** is selected.

TrueType Font

Selects the font for the stamp text string.

Style

Selects the font style for the stamp text string.

Size

Selects the font size for the stamp text string.

Outline

Selects a frame that encloses the stamp text string.

If a large font size is selected for **Size**, characters may extend outside of the stamp border.

Color/Select Color...

Shows the current color for the stamp.

To select a different color, click **Select Color...** to open the **Color** dialog box, and select or create a color you wish to use as a stamp.

When Stamp Type is Bitmap

File

Specifies the name of the bitmap file to be used as the stamp.

Select File...

Opens the dialog box to open a file.

Click this button to select a bitmap file to be used as a stamp.

Size

Adjusts the size of the bitmap file to be used as a stamp.

Moving the slider to the right increases the size, moving the slider to the left decreases the size.

Transparent white area

Specifies whether to make white-filled areas of the bitmap transparent.

Check this check box to make white-filled areas of the bitmap transparent.

»» Note

- Click **Defaults** to set **Stamp Type** to text, **Stamp Text** to blank, **TrueType Font** to Arial, **Style** to Regular, **Size** to 36 points, **Outline** unchecked, and **Color** to gray with the RGB values (192, 192, 192).

Placement Tab

The Placement tab allows you to set the position where the stamp is to be printed.

Preview Window

Shows the status of the stamp configured in each tab.

Position

Specifies the stamp position on the page.

Selecting **Custom** from the list allows you to enter values for the **X-Position** and **Y-Position** coordinates directly.

Orientation

Specifies the angle of rotation for the stamp. The angle can be set by entering the number of degrees.

Negative values rotate the stamp clockwise.

»» Note

- **Orientation** is enabled only when **Text** or **Date/Time/User Name** is selected for **Stamp Type** on the **Stamp** tab.

»» Note

- Click **Defaults** to set the stamp position to **Center** and the orientation to 0.

Save settings Tab

The **Save settings** tab allows you to register a new stamp or delete an unnecessary stamp.

Title

Enter the title to save the stamp you created.

Up to 64 characters can be entered.

»» Note

- Spaces, tabs, and returns cannot be entered at the beginning or end of a title.

Stamps

Shows a list of saved stamp titles.

Specify a title to display the corresponding stamp in **Title**.

Save/Save overwrite

Saves the stamp.

Enter a title in **Title**, and then click this button.

Delete

Deletes an unnecessary stamp.

Specify the title of an unnecessary stamp from the **Stamps** list, and click this button.

Background Tab

The Background tab allows you to select a bitmap file (.bmp) to be used as a background or determine how to print the selected background.

Preview Window

Shows the status of the bitmap set on the **Background** tab.

File

Specifies the name of the bitmap file to be used as the background.

Select File...

Opens the dialog box to open a file.

Click this button to select a bitmap file (.bmp) to be used as the background.

Layout Method

Specifies how the background image is to be placed on the paper.

When **Custom** is selected, you can set coordinates for **X-Position** and **Y-Position**.

Intensity

Adjusts the intensity of the bitmap to be used as a background.

Moving the slider to the right increases the intensity, and moving the slider to the left decreases the intensity. To print the background at the original bitmap intensity, move the slider to the rightmost position.

►► Note

- Depending on the type of printer driver you are using and the environment, this function may not be available.
- Click **Defaults** to set **File** to blank, **Layout Method** to **Fill page**, and the **Intensity** slider to the middle.

Save settings Tab

The **Save settings** tab allows you to register a new background or delete an unnecessary background.

Title

Enter the title to save the background image you specified.

Up to 64 characters can be entered.

►► Note

- Spaces, tabs, and returns cannot be entered at the beginning or end of a title.

Backgrounds

Shows a list of registered background titles.

Specify a title to display the corresponding background in **Title**.

Save/Save overwrite

Saves the image data as a background.
After inserting the **Title**, click this button.

Delete

Deletes an unnecessary background.
Specify the title of an unnecessary background from the **Backgrounds** list, and then click this button.

Maintenance tab Description

The **Maintenance** tab allows you to perform printer maintenance or change the settings of the printer.

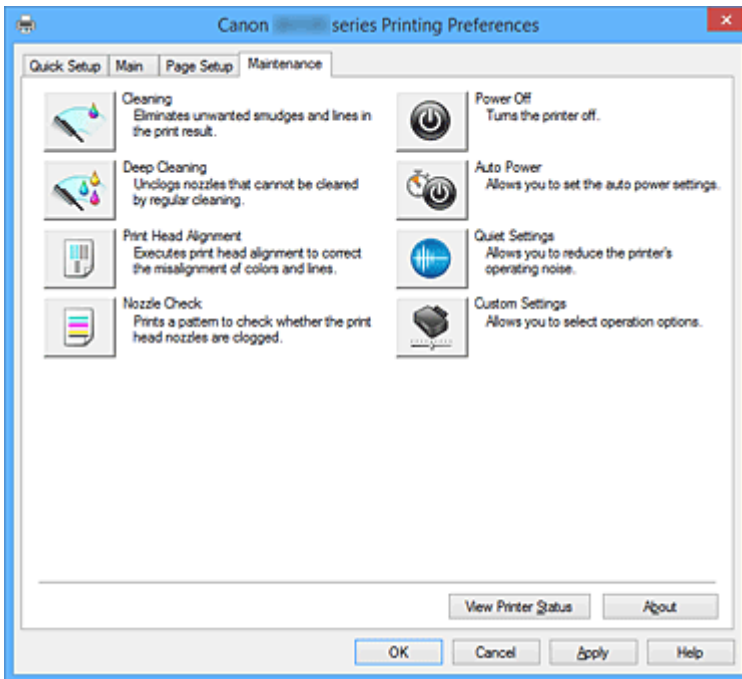

Cleaning

Performs print head cleaning.

Print head cleaning removes any blockage in the print head nozzles.

Perform cleaning when printing becomes faint, or a specific color fails to print, even though all ink levels are sufficiently high.



Deep Cleaning

Performs deep cleaning.

Perform deep cleaning when two cleaning attempts do not resolve the print head problem.

►► Note

- **Deep Cleaning** consumes a larger amount of ink than **Cleaning**.
Cleaning the print heads frequently will rapidly deplete your printer's ink supply. Therefore, perform cleaning only when necessary.

Ink Group

When you click **Cleaning** or **Deep Cleaning**, the **Ink Group** window is displayed.

Selects the ink group that you want to clean the print head for.

Click [Initial Check Items](#) to display the items that you need to check before you execute cleaning or deep cleaning.



Print Head Alignment

Print head alignment corrects the installation positions of the print head and improves deviated colors and lines.

Align the print head immediately after installing the print head.

When you click **Print Head Alignment**, the [Start Print Head Alignment dialog box](#) is displayed.



Nozzle Check

Prints a nozzle check pattern.

Perform this function if printing becomes faint or a specific color fails to print. Print a nozzle check pattern, and check whether the print head is working properly.

If the print result for a specific color is faded, or if there are any unprinted sections, click **Cleaning** to clean the print head.

To display a list of items that you should check before printing the nozzle check pattern, click [Initial Check Items](#).

Print Check Pattern

This function prints a pattern that allows you to check whether any of the ink nozzles are clogged.

Click **Print Check Pattern**. When the confirmation message is displayed, click **OK**. The **Pattern Check** dialog box is then displayed.

Left-side bitmap (good)

The print head nozzles are not clogged.

Right-side bitmap (bad)

The print head nozzles may be clogged.

Exit

Closes the **Pattern Check** dialog box, and returns to the **Maintenance** tab.

Cleaning

Performs print head cleaning.

Print head cleaning removes any blockage in the print head nozzles.

Perform cleaning when printing becomes faint, or if a specific color fails to print, even though all ink levels are sufficiently high.



Power Off

Turns off the printer from the printer driver.

Perform this function to turn off the printer when you cannot press the ON button (POWER button) on the printer because the printer is out of your reach.

You must press the ON button (POWER button) on the printer to turn the printer on again after clicking this button. When you use this function, you will not be able to turn the printer on from the printer driver.



Auto Power

Opens the [Auto Power Settings dialog box](#).

Specify settings for operating the printer power automatically. Perform this function if you want to change the auto power settings.

▶▶▶ Note

- If the printer is off or if communication between the printer and the computer is disabled, an error message may appear because the computer cannot collect the printer status.
If this happens, click **OK** to display the most recent settings specified on your computer.



Quiet Settings

Opens the [Quiet Settings dialog box](#).

Quiet Settings dialog box allows you to specify a setting that reduces the operating noise of the printer. This mode comes in handy when the operating noise of the printer becomes a concern, such when printing at night. Perform this operation when you want to change the quiet mode setting.

▶▶▶ Note

- If the printer is off or if communication between the printer and the computer is disabled, an error message may appear because the computer cannot collect the printer status.



Custom Settings

Opens the [Custom Settings dialog box](#).

Perform this function to change the settings of this printer.

▶▶▶ Note

- If the printer is off or if communication between the printer and the computer is disabled, an error message may appear because the computer cannot collect the printer status.
If this happens, click **OK** to display the most recent settings specified on your computer.

View Print History

This function starts the Canon IJ XPS preview, and displays the print history.

▶▶▶ Note

- You can use this function only with the XPS printer driver.

View Printer Status

Starts the Canon IJ Status Monitor.

Perform this function when you want to check the printer status and how a print job is proceeding.

▶▶▶ Note

- If you are using the XPS printer driver, the "Canon IJ Status Monitor" becomes the "Canon IJ XPS Status Monitor".

About

Opens the [About dialog box](#).

The version of the printer driver, plus a copyright notice, can be checked.

In addition, the language to be used can be switched.

Initial Check Items (Cleaning / Deep Cleaning)

Before running **Cleaning** or **Deep Cleaning**, check that the printer power is on, and open the cover of the printer.

Check the following items for each ink.

- [Check the amount of ink](#) remaining in the tank.
- Make sure that you push in the ink tank completely until you hear a clicking sound.
- If an orange tape is adhered to the ink tank, peel it off completely.
Any remaining tape will hinder ink output.
- Check that the ink tanks are installed in their correct positions.

Start Print Head Alignment dialog box

This dialog box allows you to adjust the attachment position for the print head, or to print the current setting value for the print head position.

Align Print Head

Aligns the print head.

Print head alignment corrects the installation positions of the print head and improves deviated colors and lines.

Align the print head immediately after installing the print head.

Print Alignment Value

Click this button to check the current setting value of the print head position.

Prints the current setting value for the print head position.

Print Head Alignment dialog box

To adjust the print head position manually, click **Align Print Head** in the **Start Print Head Alignment** dialog box, and perform the operations instructed in the messages. The **Print Head Alignment** dialog box is then displayed.

This dialog box allows you to check the printed pattern and adjust the print head position.

Preview Window

Displays the pattern of **Print Head Alignment**, and checks the position of the selected pattern.

You can also change the setting by clicking the pattern on the screen directly.

Select the Pattern Number

Compare the printed adjustment patterns, and enter the pattern number of the pattern with the least visible streaks or horizontal stripes into the corresponding box.

▶▶▶ Note

- If you do not know how to analyze the printed pattern, see [Aligning the Print Head Position](#).

Initial Check Items (Nozzle Check)

Before running **Nozzle Check**, check that the printer power is on, and open the cover of the printer. Check the following items for each ink.

- [Check the amount of ink](#) remaining in the tank.
- Make sure that you push in the ink tank completely until you hear a clicking sound.
- If an orange tape is adhered to the ink tank, peel it off completely. Any remaining tape will hinder ink output.
- Check that the ink tanks are installed in their correct positions.

Auto Power Settings dialog box

When you click **Auto Power**, the **Auto Power Settings** dialog box is displayed. This dialog box allows you to manage the printer power from the printer driver.

Auto Power On

Selects the auto power-on setting.

Specify **Disable** to prevent the printer from turning on automatically when print data is sent to it.

Make sure the printer is on and then click **OK** to change the printer settings.

Specify **Enable** to turn the printer on automatically when print data is sent to it.

Auto Power Off

Selects the auto power-off setting.

If a printer driver operation or a printer operation is not performed within the specified time, the printer turns off.

Quiet Settings dialog box

When you click **Quiet Settings**, the **Quiet Settings** dialog box is displayed.

Quiet Settings dialog box allows you to specify a setting that reduces the operating noise of the printer.

Select when you wish to reduce the operating noise of the printer at night, etc.

Using this function may lower the print speed.

Do not use quiet mode

Select this option when you wish to use the printer with volume of normal operating noise.

Always use quiet mode

Select this option when you wish to reduce the operating noise of the printer.

Use quiet mode during specified hours

Select this option when you wish to reduce the operating noise of the printer during a specified period of time.

Set the **Start time** and the **End time** of the quiet mode you wish to be activated. If both are set to the same time, the quiet mode will not function.

►► Important

- You can set the quiet mode from the printer or the printer driver. No matter how you use to set the quiet mode, the mode is applied when you perform operations from the printer or printing from the computer.

Custom Settings dialog box

When you click **Custom Settings**, the **Custom Settings** dialog box is displayed.

If necessary, switch between various modes of printer operation.

Prevent paper abrasion

The printer can increase the gap between the print head and the paper during high-density printing to prevent paper abrasion.

Check this check box to enable this function.

Align heads manually

Usually, the **Print Head Alignment** function on the **Maintenance** tab is set to automatic head alignment, but you can change it to manual head alignment.

If the printing results of automatic print head alignment are not satisfactory, [perform manual head alignment](#).

Check this check box to perform the manual head alignment.

Rotate 90 degrees left when orientation is [Landscape]

On the **Page Setup** tab, you can change the rotation direction of the **Landscape** in the **Orientation**. To rotate the document 90 degrees to the left when printing, select the check box.

▶▶▶ Note

- If **Yougata 4 4.13"x9.25"**, **Yougata 6 3.86"x7.48"**, **Envelope Com 10**, **Envelope DL**, **Envelope C5**, or **Envelope Monarch 3.88"x7.5" 98.4x190.5mm** is selected for **Page Size** on the **Page Setup** tab, the printer rotates the paper 90 degrees to the left to print, regardless of the **Rotate 90 degrees left when orientation is [Landscape]** setting for **Custom Settings** on the **Maintenance** tab.

Don't detect mismatch of paper settings when printing from computer

When you print documents from your computer and the paper settings on the printer driver and the cassette paper information registered on the printer do not match, this setting disables the message display and allows you to continue printing.

To disable detection of paper setting mismatches, select this check box.

Ink Drying Wait Time

The printer can pause before printing a subsequent page. Moving the slider to the right increases the pause time, and moving the slider to the left decreases the time.

If the paper gets stained because the next page is ejected before the ink on the printed page dries, increase the ink drying wait time.

Reducing the ink drying wait time speeds up printing.

About dialog box

When you click **About**, the **About** dialog box is displayed.

This dialog box displays the version, copyright, and module list of the printer driver. You can select the language to be used and switch the language displayed in the setup window.

Modules

Lists the printer driver modules.

Language

Specifies the language you wish to use in the [printer driver setup window](#).

»» Important

- If the font for displaying the language of your choice is not installed in your system, the characters will be garbled.

Related Topics

- [Cleaning the Print Heads](#)
- [Aligning the Print Head Position](#)
- [Printing a Nozzle Check Pattern](#)
- [Managing the Printer Power](#)
- [Reducing the Printer Noise](#)
- [Changing the Printer Operation Mode](#)

Canon IJ Preview Description

Canon IJ Preview is an application software that displays what the print result will look like before a document is actually printed.

The preview reflects the information that is set within the printer driver and allows you to check the document layout, print order, and number of pages. You can also change the media type and paper source settings.

When you want to display a preview before printing, open the [printer driver setup window](#), and check the **Preview before printing** check box on the **Main** tab.

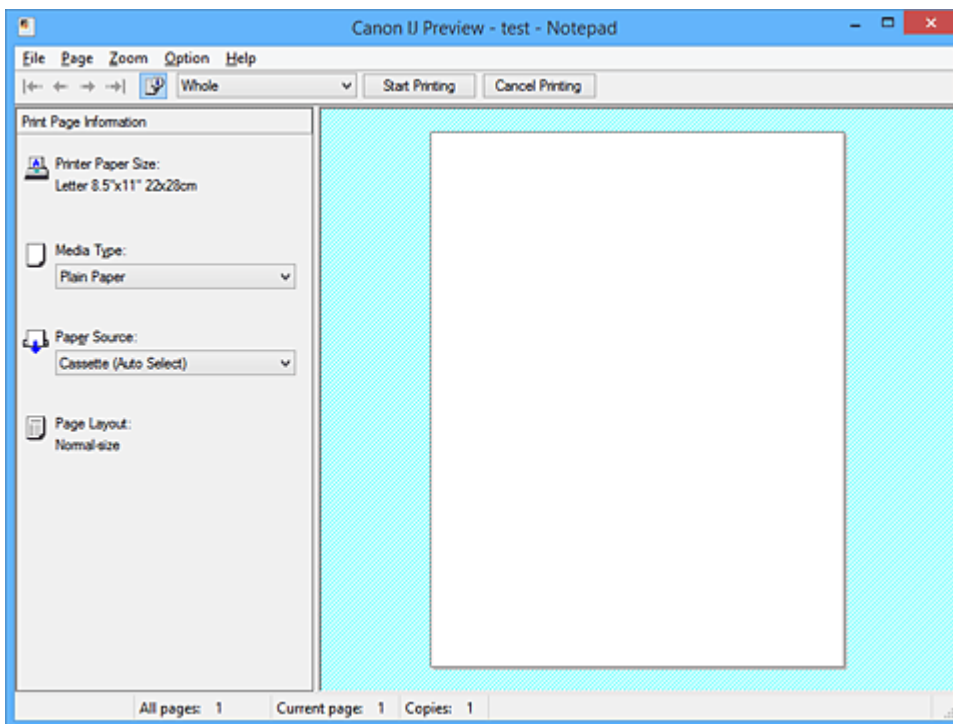

File Menu

Selects the print operation.

Start Printing

Ends the Canon IJ Preview and then starts printing the document that is displayed on the preview screen.

This command has the same function as the **Start Printing** on the toolbar.

Cancel Printing

Ends the Canon IJ Preview and cancels the printing of the document that is displayed on the preview screen.

This command has the same function as the **Cancel Printing** on the toolbar.

Exit

Ends the Canon IJ Preview.

Page Menu

This menu includes the following commands to select page to be displayed.

All of these commands except **Page Selection...** can also be selected from the toolbar.

▶▶▶ Note

- If the pages are being spooled, the last spooled page becomes the last page.

- If the **Page Layout** setting on the **Page Setup** tab is specified to **Page Layout**, **Tiling/Poster**, or **Booklet**, the number of pages is the number of sheets to be used for printing, and not the number of pages in the original document created with the application software.
- If duplex printing manually has been set, the front pages which will be printed first are all displayed together, and then the back pages are displayed.

First Page

Displays the first page of the document.

If the currently displayed page is the first page, this command is grayed out and cannot be selected.

Previous Page

Displays the page located before the currently displayed page.

If the currently displayed page is the first page, this command is grayed out and cannot be selected.

Next Page

Displays the page located after the currently displayed page.

If the currently displayed page is the last page, this command is grayed out and cannot be selected.

Last Page

Displays the last page of the document.

If the currently displayed page is the last page, this command is grayed out and cannot be selected.

Page Selection...

Displays the **Page Selection** dialog box.

This command allows you to specify the page number of the page to be displayed.

Zoom Menu

Selects the ratio of the actual size printed on the paper to the preview display size.

You can also select the ratio from the drop-down list box located on the toolbar.

Whole

Displays the entire page of data as one page.

50%

Reduces the displayed data to 50% of the actual size to be printed.

100%

Displays the data at the actual size to be printed.

200%

Enlarges the displayed data to 200% of the actual size to be printed.

400%

Enlarges the displayed data to 400% of the actual size to be printed.

Option Menu

This menu includes the following command:

Displays Print Page Information

Displays print setup information (including printer paper size, media type, and page layout) for each page at the left side of the preview screen.

This screen also allows you to change the media type and paper source settings.

Help Menu

When you select this menu item, the Help window for Canon IJ Preview is displayed, and you can check the version and copyright information.

Start Printing button

Prints the documents selected in the document list.

The printed documents are deleted from the list, and when all documents are printed, the Canon IJ XPS Preview closes.

Cancel Printing button

Ends the Canon IJ Preview, and cancels the printing of the document that is displayed on the preview screen.

You can click this button while spooling.

Print Page Information Screen

Displays print setup information for each page at the left side of the preview screen.

This screen also allows you to change the media type and paper source settings.

Important

- If the media type and paper source are set from the application software, those settings have priority and the changed settings may become ineffective.

Printer Paper Size

Displays the paper size of the document to be printed.

Media Type

You can select the media type of the document to be printed.

Paper Source

You can select the paper source of the document to be printed.

Page Layout

Displays the page layout of the document to be printed.

Canon IJ XPS Preview Description

Canon IJ XPS Preview is an application software that displays what the print result will look like before a document is actually printed.

The preview reflects the information which is set within the printer driver and allows you to check the document layout, print order, and number of pages. The preview also allows you to edit the print document, edit the print pages, change the print settings, and perform other functions.

When you want to display a preview before printing, open the [printer driver setup window](#), and check the **Preview before printing** check box on the **Main** tab.

►►► Important

- To use the Canon IJ XPS Preview, you must have Microsoft .NET Framework 4 Client Profile installed on your computer.

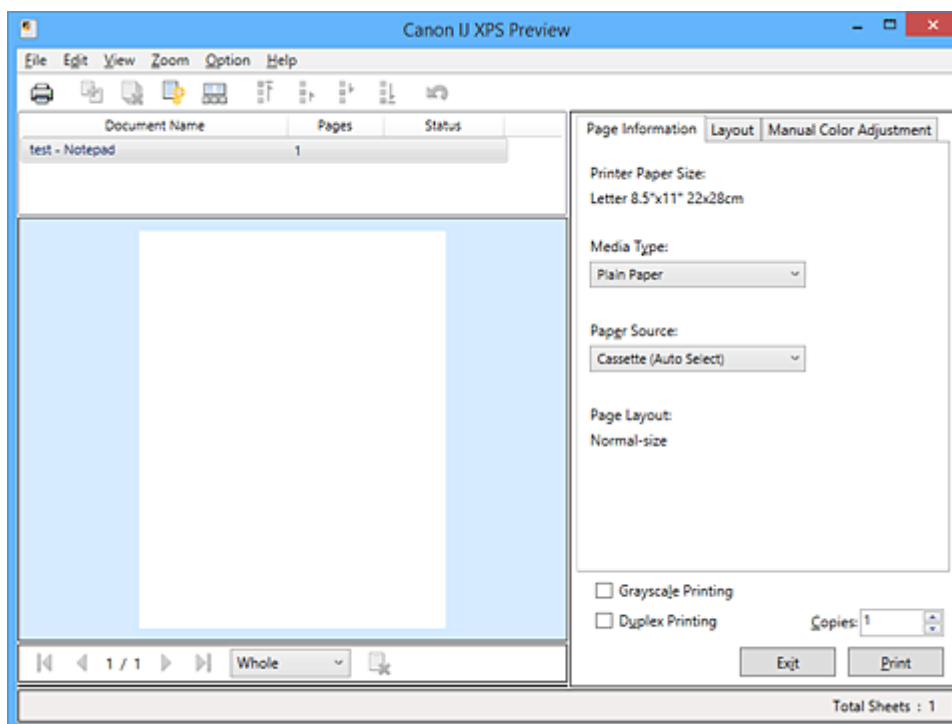

File Menu

Selects print operation and print history settings:

Print

Prints the documents selected in the document list.

The printed documents are deleted from the list, and when all documents are printed, the Canon IJ XPS Preview closes.

This command has the same function as  (Print) on the toolbar and the **Print** in the print settings area.

Print All Documents

Prints all documents in the document list and closes the Canon IJ XPS Preview.

Save Print History

Switches whether the documents printed from the Canon IJ XPS Preview are to be saved as print history entries.

History Entry Limit

Switches the maximum number of print history registrations.

Select **10 Entries**, **30 Entries**, or **100 Entries**.

Important

- If the limit on the number of registration is exceeded, the print history registrations are deleted starting from the oldest one.

Add documents from history to the list

Adds the document saved in the print history to the document list.

Exit

Ends the Canon IJ XPS Preview. The documents remaining in the document list will be deleted from the list.

This command has the same function as the **Exit** in the print settings area.

Edit Menu

Selects the method for editing multiple documents or pages.

Undo

Reverses the previous change.

If the change cannot be reversed, this function is grayed out and cannot be selected.

This command has the same function as the  (Undo) on the toolbar.

Documents

Selects the method for editing print documents.

Combine Documents

Combines the documents selected in the document list into one document.

If only one document is selected, this command is grayed out and cannot be selected.

This command has the same function as the  (Combine Documents) on the toolbar.

Reset Documents

Returns the document selected in the document list to their status before they were added to the Canon IJ XPS Preview.

The combined documents are separated, and the original documents are restored.

This command has the same function as the  (Reset Documents) on the toolbar.

Move Document

Use the following command to change the order of the documents selected in the document list.

Move to First

Moves the selected print document to the beginning of the document list.

If the currently selected document is the first document, this command is grayed out and cannot be selected.

Move Up One

Moves the selected print document one up from its current position.

If the currently selected document is the first document, this command is grayed out and cannot be selected.

Move Down One

Moves the selected print document one down from its current position.

If the currently selected document is the last document, this command is grayed out and cannot be selected.

Move to Last

Moves the selected print document to the end of the document list.

If the currently selected document is the last document, this command is grayed out and cannot be selected.

Delete Document

Deletes the selected document from the document list.

If the document list contains only one document, the document is grayed out and cannot be selected.

This command has the same function as the  (Delete Document) on the toolbar.

Grayscale Printing

Allows you to change the monochrome print settings.

This command has the same functionality as the **Grayscale Printing** check box in the print settings area.

Page Layout Printing...

Opens the **Page Layout Printing** dialog box.

This dialog box allows you to set **Page Layout Printing**, **Page Layout**, **Page Order**, and **Page Border**.

Duplex Printing...

Opens the **Duplex Printing** dialog box.

This dialog box allows you to set **Duplex Printing**, **Automatic**, **Stapling Side**, and **Margin**.

Copies...

Opens the **Copies** dialog box.

This dialog box allows you to set **Copies**, **Collate**, and **Print from Last Page**.

Pages

Selects the method for editing print pages.

Delete Page

Deletes the currently selected page.

If page layout printing is set, the pages enclosed with red frame will be deleted.

This command has the same function as the  (Delete Page) on the toolbar.

Restore Page

Restores pages that were deleted with the **Delete Page** function.

To restore pages, you must select the **View Deleted Pages** check box on the **Option** menu and display the deleted pages as thumbnails.

Move Page

Use the following command to change the order of the currently selected pages.

Move to First

Moves the currently selected page to the beginning of the document.

If the currently selected page is the first page, this command is grayed out and cannot be selected.

Move Forward One

Moves the currently selected page one position in front of its current position.

If the currently selected page is the first page, this command is grayed out and cannot be selected.

Move Backward One

Moves the currently selected page one position after its current position.

If the currently selected page is the last page, this command is grayed out and cannot be selected.

Move to Last

Moves the currently selected page to the end of the document.

If the currently selected page is the last page, this command is grayed out and cannot be selected.

View Menu

Selects the documents and pages to be displayed.

Documents

Use the following command to select the document to display.

First Document

Displays the first document in the document list.

If the currently selected document is the first document, this command is grayed out and cannot be selected.

Previous Document

Displays the document located before the currently displayed document.

If the currently selected document is the first document, this command is grayed out and cannot be selected.

Next Document

Displays the document located after the currently displayed document.

If the currently selected document is the last document, this command is grayed out and cannot be selected.

Last Document

Displays the last document in the document list.

If the currently selected document is the last document, this command is grayed out and cannot be selected.

Pages

Use the following command to select the page to be displayed.

»» Note

- If the **Page Layout** setting in the printer driver is specified to **Tiling/Poster**, or **Booklet**, the number of pages is the number of sheets to be used for printing, and not the number of pages in the original document created with the application software.

First Page

Displays the first page of the document.

If the currently displayed page is the first page, this command is grayed out and cannot be selected.

Previous Page

Displays the page located before the currently displayed page.

If the currently displayed page is the first page, this command is grayed out and cannot be selected.

Next Page

Displays the page located after the currently displayed page.

If the currently displayed page is the last page, this command is grayed out and cannot be selected.

Last Page

Displays the last page of the document.

If the currently displayed page is the last page, this command is grayed out and cannot be selected.

Page Selection...

Displays the **Page Selection** dialog box.

This command allows you to specify the page number of the page to be displayed.

Zoom Menu

Selects the ratio of the actual size printed on the paper to the preview display size.

You can also select the ratio from the drop-down list box located on the toolbar.

Whole

Displays the entire page of data as one page.

50%

Reduces the displayed data to 50% of the actual size to be printed.

100%

Displays the data at the actual size to be printed.

200%

Enlarges the displayed data to 200% of the actual size to be printed.

400%

Enlarges the displayed data to 400% of the actual size to be printed.

Option Menu

Toggles the show / hide status of the following information.

View Thumbnails

Reduces all pages in the document selected in the document list and displays them at the bottom of the preview window.

This command has the same function as the  (View Thumbnails) on the toolbar.

View Document List

Displays the print document list at the top of the preview window.

View Print Settings Area

Displays the print settings area at the right side of the preview window.

View Deleted Pages

When the thumbnails are displayed, this function displays pages that were deleted with the **Delete Page** function.

To check deleted pages, you must first select the **View Thumbnails** check box.

Keep printed documents on the list

Leaves the printed document in the document list.

Print Settings Displayed at Startup

Switches the tab of the print settings area to be displayed when the Canon IJ XPS Preview is started.

Select **Page Information**, **Layout**, or **Manual Color Adjustment**.

Help Menu

When you select this menu item, the Help window for Canon IJ XPS Preview is displayed, and you can check the version and copyright information.



(Print)

Prints the documents selected in the document list.

The printed documents are deleted from the list, and when all documents are printed, the Canon IJ XPS Preview closes.



(Combine Documents)

Combines the documents selected in the document list into one document.

If only one document is selected, this command is grayed out and cannot be selected.



(Delete Document)

Deletes the selected document from the document list.

If the document list contains only one document, the document is grayed out and cannot be selected.



(Reset Documents)

Returns the document selected in the document list to their status before they were added to the Canon IJ XPS Preview.

The combined documents are separated, and the original documents are restored.



(View Thumbnails)

Reduces all pages in the document selected in the document list and displays them at the bottom of the preview window.

To hide the print pages, click **View Thumbnails** again.



(Move to First)

Moves the selected print document to the beginning of the document list.

If the currently selected document is the first document, this command is grayed out and cannot be selected.



(Move Up One)

Moves the selected print document one up from its current position.

If the currently selected document is the first document, this command is grayed out and cannot be selected.



(Move Down One)

Moves the selected print document one down from its current position.

If the currently selected document is the last document, this command is grayed out and cannot be selected.

(Move to Last)

Moves the selected print document to the end of the document list.

If the currently selected document is the last document, this command is grayed out and cannot be selected.

(Undo)

Reverses the previous change.

If the change cannot be reversed, this function is grayed out and cannot be selected.

(Delete Page)

Deletes the currently selected page.

If page layout printing is set, the pages enclosed with red frame will be deleted.

Document list

Displays the list of the print documents.

The document selected in the document list becomes the target for preview display and editing.

Document Name

Displays the name of the print document.

If you click the name of the selected print document, a text box is displayed, and you can rename the document to any name.

Pages

Displays the number of pages in the print document.

Important

- The number displayed in **Pages** and the output page count are different.
- To check the output page count, check the status bar at the bottom of the preview window.

Status

Displays the status of the print documents.

Documents that are undergoing data processing are displayed as **Processing data**.

Important

- Documents showing **Processing data** cannot be printed or edited.
Wait until the data processing ends.

Print Settings Area Screen

Allows you to check and change the print settings of the documents selected in the document list.

Print Settings Area is displayed on the right side of the preview window.

Page Information tab

The print settings are displayed for each page.

You can change the media type and paper source settings.

Printer Paper Size

Displays the paper size of the document to be printed.

Media Type

Allows you to select the media type of the document to be printed.

Paper Source

Allows you to select the paper source of the document to be printed.

Page Layout

Displays the page layout of the document to be printed.

Layout tab

You can specify settings for page layout printing.

To apply the specified settings, click **Apply**.

If the page layout print settings cannot be changed for the print document, the individual items are grayed out and cannot be selected.

Manual Color Adjustment tab

This tab allows you to adjust the color balance by changing the settings of the **Cyan, Magenta, Yellow, Brightness, Intensity, and Contrast** options.

Cyan/Magenta/Yellow

Adjusts the strengths of **Cyan, Magenta, and Yellow**.

Moving the slider to the right makes a color stronger, and moving the slider to the left makes a color weaker.

You can also directly enter a value linked to the slider. Enter a value in the range from -50 to 50.

This adjustment changes the relative amount of ink of each color used, which alters the total color balance of the document.

Use your application software if you want to change the total color balance significantly. Use the printer driver only if you want to adjust the color balance slightly.

»» Important

- When **Grayscale Printing** is checked, **Cyan, Magenta, and Yellow** appear grayed out and are unavailable.

Brightness

Selects the brightness of your print.

Pure white and black will not change, but colors between white and black will change.

Intensity

Adjusts the overall intensity of your print.

Moving the slider to the right increases the intensity, and moving the slider to the left decreases the intensity.

You can also directly enter a value linked to the slider. Enter a value in the range from -50 to 50.

Contrast

Adjusts the contrast between light and dark in the image to be printed.

Moving the slider to the right increases the contrast, moving the slider to the left decreases the contrast.

You can also directly enter a value linked to the slider. Enter a value in the range from -50 to 50.

Defaults

Restores all the settings you have changed to their default values.

Clicking this button restores all the settings on this tab to their default values (factory settings).

Grayscale Printing

Allows you to change the monochrome print settings.

Duplex Printing

Selects whether to print the document on both sides or one side of a sheet of paper.

If the duplex print settings cannot be changed for the print document, this item is grayed out and is unavailable.

Important

- When you select **Booklet** for **Page Layout**, **Duplex Printing** of the print settings area will be set automatically. In this case, **Duplex Printing** is grayed out and is unavailable.

Copies

Specifies the number of copies you want to print. You can specify a value from 1 to 999.

If the numbers of copies cannot be changed for the print document, this item is grayed out and is unavailable.

Exit

Ends the Canon IJ XPS Preview.

The documents remaining in the document list will be deleted from the list.

Print

Prints the documents selected in the document list.

The printed documents are deleted from the list, and when all documents are printed, the Canon IJ XPS Preview closes.

Canon IJ Status Monitor Description

The Canon IJ Status Monitor displays the status of the printer and the printing progress. The monitor uses graphics, icons, and messages to let you know the printer status.

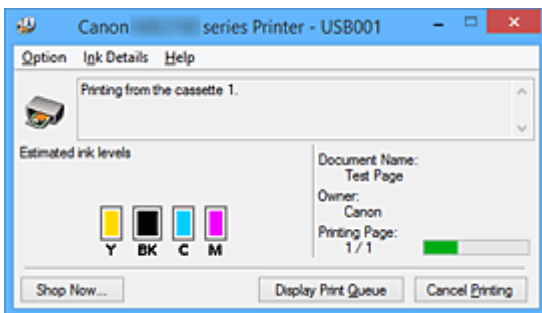

Canon IJ Status Monitor Features

The Canon IJ Status Monitor offers the following advantages:

You can check the status of the printer on the screen.

The status of the printer is shown on the screen in real time.

You can check the printing progress of each printing document (print job).

Error types and solutions are shown on the screen.

Shown when a printer error occurs.

You can immediately check how to respond.

You can check the ink status.

This function displays graphics showing the ink tank type and the estimated ink levels.

Icons and messages are displayed when ink is running low (ink level warning).

Canon IJ Status Monitor Overview

Canon IJ Status Monitor allows you to check the status of the printer and ink with graphics and messages.

You can check the information on the printing document and the printing progress during printing.

When a printer error occurs, it shows the cause and solution. Follow the instruction in the message.

Printer

Canon IJ Status Monitor shows an icon when a warning or error occurs to the printer.

⚠ : Indicates that a warning (operator call error) has occurred or the printer is working.

✖ : There has been an error which requires a service.

Ink Tank

Canon IJ Status Monitor shows an icon when a low ink warning or a no ink error occurs.

In addition, this function displays graphics showing the estimated ink levels of the ink tank.

In this case, click the graphics to open the **Ink Details** dialog box. You can check the detail information such as the remaining ink level and the ink tank types for your printer.

Document Name

Shows the name of the document to be printed.

Owner

Shows the owner's name of the document to be printed.

Printing Page

Shows the number of printing page and total printing pages.

Display Print Queue

Shows the print window used to manage the print job that is being printed or being in the print queue.

Cancel Printing

Cancels the current print job.

Important

- The **Cancel Printing** button is enabled only while print data is being sent to the printer. Once the print data has been sent, the button is grayed out and becomes unavailable.

Option Menu

If you select **Enable Status Monitor**, when a printer related message is generated the Canon IJ Status Monitor starts.

When **Enable Status Monitor** is selected, following commands are available.

Always Display Current Job

Displays the Canon IJ Status Monitor during printing.

Always Display on Top

Displays the Canon IJ Status Monitor in front of other windows.

Display Guide Message

Displays the guide for operations in which how to set paper is complicated.

Envelope Printing

Displays the guide message when envelope printing starts.

To hide this guide message, select the **Do not show this message again** check box.

To display the guide messages again, click **Envelope Printing** on the **Display Guide Message** in the **Option** menu and enable this setting.

Hagaki Printing

Displays the guide message before the printer begins hagaki printing.

To hide this guide message, select the **Do not show this message again** check box.

To display the guide messages again, click **Hagaki Printing** on the **Display Guide Message** in the **Option** menu and enable this setting.

Display Warning Automatically

When a Low Ink Warning Occurs

Starts the Canon IJ Status Monitor window automatically and displays it in front of the other windows when a low ink warning occurs.

Start when Windows is Started

Starts the Canon IJ Status Monitor automatically when you start Windows.

Ink Details Menu

Select this menu to display the **Ink Details** dialog box. Check the detail information such as the remaining ink level and the ink tank types for your printer.

Ink Details dialog box

This function displays graphics and messages showing the ink tank type and the estimated ink levels.

Ink Information (displayed at left)

Shows the ink tank types with graphics.

If a warning or error related to the remaining ink level occurs, the printer driver displays an icon to let you know.

If the icon is displayed, operate the printer according to the instructions displayed on the screen.

Message (displayed at right)

Shows information such as the ink status and ink colors with sentences.

Ink Model Number

Shows the ink tank types for your printer.

Close

Closes the **Ink Details** dialog box to return to Canon IJ Status Monitor.

Help Menu

When you select this menu item, the Help window for Canon IJ Status Monitor is displayed, and you can check the version and copyright information.

Updating the Printer Driver

- **Obtaining the Latest Printer Driver**
- **Deleting the Unnecessary Printer Driver**
- **Before Installing the Printer Driver**
- **Installing the Printer Driver**

Obtaining the Latest Printer Driver

By updating the printer driver to the latest version of the printer driver, unresolved problems may be solved. You can check the version of the printer driver by clicking the **About** button on the **Maintenance** tab.

You can access our website and download the latest printer driver for your model.

Important

- You can download the printer driver for free, but any Internet access charges incurred are your responsibility.
- Before installing the latest printer driver, [delete the previously installed version](#).

Related Topics

- [Before Installing the Printer Driver](#)
- [Installing the Printer Driver](#)

Deleting the Unnecessary Printer Driver

The printer driver which you no longer use can be deleted.

When deleting the printer driver, first exit all programs that are running.

The procedure to delete the unnecessary printer driver is as follows:

1. Start the uninstaller

Select **Control Panel** -> **Programs** -> **Programs and Features**.

From the program list, select "XXX Printer Driver" (where "XXX" is your model name) and then click **Uninstall**.

The confirmation window for uninstalling the model appears.

»»» Important

- A confirmation/warning dialog box may appear when starting, installing or uninstalling software. This dialog box appears when administrative rights are required to perform a task. When you are logged on to an administrator account, click **Yes** (or **Continue**, **Allow**) to continue. Some applications require an administrator account to continue. In such cases, switch to an administrator account, and restart the operation from the beginning.

2. Execute the uninstaller

Click **Execute**. When the confirmation message appears, click **Yes**.

When all the files have been deleted, click **Complete**.

The deletion of the printer driver is complete.

»»» Important

- Printer driver and XPS printer driver will be deleted when you uninstall the Printer Driver.

Before Installing the Printer Driver

This section describes the items that you should check before installing the printer driver. You should also refer to this section if the printer driver cannot be installed.

Checking the Printer Status

- Turn off the printer.

Checking the Personal Computer Settings

- Terminate all running applications.
- Log on as a user who has the administrator account.

»» Important

- Before installing the latest printer driver, [delete the previously installed version](#).

Related Topics

- [Obtaining the Latest Printer Driver](#)
- [Installing the Printer Driver](#)

Installing the Printer Driver

You can access our web site through the Internet and download the latest printer driver and XPS printer driver for your model.

The procedure for installing the downloaded printer driver is as follows:

1. Turn off the printer

2. Start the installer

Double-click the icon of the downloaded file.

The installation program starts.

▶▶▶ Important

- A confirmation/warning dialog box may appear when starting, installing or uninstalling software. This dialog box appears when administrative rights are required to perform a task. When you are logged on to an administrator account, click **Yes** (or **Continue**, **Allow**) to continue. Some applications require an administrator account to continue. In such cases, switch to an administrator account, and restart the operation from the beginning.

3. Install the printer driver

Take the appropriate action as described on the screen.

4. Complete the installation

Click **Complete**.

Depending on the environment you are using, a message prompting you to restart the computer may be displayed. To complete the installation properly, restart the computer.

▶▶▶ Important

- You can install the XPS printer driver with the same procedure for installing the printer driver. However, when installing the XPS printer driver, first complete installation of the printer driver.
- You can download the printer driver and XPS printer driver for free, but any Internet access charges incurred are your responsibility.
- Before installing the latest printer driver, [delete the previously installed version](#).

Related Topics

- [Obtaining the Latest Printer Driver](#)
- [Deleting the Unnecessary Printer Driver](#)
- [Before Installing the Printer Driver](#)

Printing Using a Web Service

- **Using PIXMA/MAXIFY Cloud Link**
- **Printing with Google Cloud Print**

Using PIXMA/MAXIFY Cloud Link

By using PIXMA/MAXIFY Cloud Link, you can connect your printer to a cloud service, such as CANON IMAGE GATEWAY, Evernote, or Twitter, and use the following functions without using a computer:

- Print images from a photo-sharing service
- Print documents from a data management service
- Save scanned images to a data management service.
- Use Twitter to report the printer status, such as no paper or low ink levels.

In addition, you can use various functions by adding and registering apps that are linked with various cloud services.

■ Using PIXMA/MAXIFY Cloud Link from Your Printer

■ [Using PIXMA/MAXIFY Cloud Link from Your Smartphone, Tablet, or Computer](#)



▶▶▶ Important

- In certain countries, PIXMA/MAXIFY Cloud Link may not be available or the available apps may be different.
- Some apps require that you have an account before you use those apps. For such apps, please set up an account beforehand.
- To find out which models support PIXMA/MAXIFY Cloud Link check the Canon homepage.
- The screen display may change without prior notice.

Printing with Google Cloud Print

The printer is compatible with Google Cloud Print™ (Google Cloud Print is a service provided by Google Inc.).

By using Google Cloud Print, you can print from anywhere with applications or services supporting Google Cloud Print.

Sending Print Data and Printing via Internet



Once you register the printer to Google Cloud Print, you can print from applications or services supporting Google Cloud Print without internet connection.

Sending Print Data and Printing without Going through Internet



»» Important

- This function may not be available depending on the country or region you live in.
- To use Google Cloud Print, you need to get Google account and register the printer with Google Cloud Print in advance.

Additionally, LAN connection with the printer and internet connection are required to register the printer to Google Cloud Print. Internet connection fees apply.

1. [Getting Google Account](#)
2. [Registering Printer with Google Cloud Print](#)
3. [Printing from Computer or Smartphone with Google Cloud Print](#)

»» Important

- When the printer owner changes, delete its registration from Google Cloud Print.

■ [Deleting Printer from Google Cloud Print](#)

LAN connection with the printer and internet connection are required to delete the printer from Google Cloud Print. Internet connection fees apply.

Getting Google Account

To print with Google Cloud Print, you need to get Google account and register the printer with Google Cloud Print in advance.

▶▶▶ Note

- If you already have Google account, register the printer to Google Cloud Print.

■ [Registering Printer with Google Cloud Print](#)

Access to Google Cloud Print with the web browser on the computer or the mobile device and register the required information.

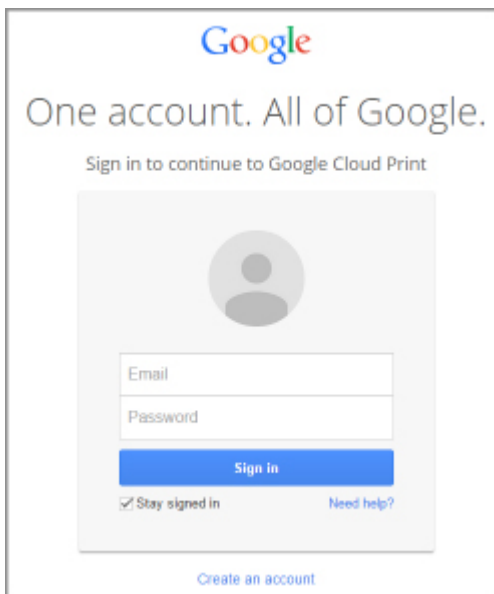

The image shows a screenshot of a Google sign-in page. At the top is the Google logo. Below it is the text "One account. All of Google." followed by "Sign in to continue to Google Cloud Print". In the center is a grey box containing a circular profile picture placeholder, an "Email" input field, a "Password" input field, and a blue "Sign in" button. Below the input fields are two links: "Stay signed in" with a checked checkbox and "Need help?". At the bottom of the grey box is a link "Create an account".

* The screen above may change without prior notice.

Registering Printer with Google Cloud Print

The printer can be registered to Google Cloud Print with the following two methods.



■ [Registration Using Google Chrome](#)

■ [Registration Using Printer](#)

▶▶▶ Important

- If you have not gotten Google account, get it.
 - [Getting Google Account](#)
- When the printer owner changes, delete its registration from Google Cloud Print.
 - [Deleting Printer from Google Cloud Print](#)
- LAN connection with the printer and internet connection are required to register the printer to Google Cloud Print and to delete it. Internet connection fees apply.

Registration Using Google Chrome

1. Start Google Chrome browser on your computer.
2. Select **Sign in to Chrome...** from  (Chrome menu).
3. Log in to your Google account.
4. Select **Settings** from  (Chrome menu).
5. Select **Show advanced settings...** to display information.
6. Select **Manage** for **Google Cloud Print**.
7. When **Canon iB4100 series** and **Add printers** button are displayed, select **Add printers**.
8. When confirmation message for registering printer appears, select **OK**.
9. When register confirmation screen is displayed on printer's LCD, select **Yes** and press **OK** button.

Printer registration is complete.

Registration Using Printer

»» Important

- Entering the administrator password may be required depending on the range of administrator password.

1. [Make sure printer is turned on.](#)
2. Press **Setup** button.
The **Setup menu** screen is displayed.
3. Select **Web service setup** and press **OK** button.
4. Select **GoogleCloudPrint** -> **Register w/ service.**

»» Note

- If you have already registered the printer with Google Cloud Print, the confirmation message to re-register the printer is displayed.

5. When confirmation screen to register printer is displayed, select **Yes** and press **OK** button.
6. Select language on print setting screen of Google Cloud Print and press **OK** button.
The confirmation message to print the authentication URL is displayed.
7. Load A4 or Letter-sized plain paper and press **OK** button.
The authentication URL is printed.
8. Make sure authentication URL is printed, and then press **OK** button.
9. Perform authentication process using web browser on computer or mobile device.

Access to the URL using the web browser on the computer or the mobile device and perform the authentication process following the on-screen instructions.

»» Important

- Accessing to printed URL and performing the authentication process have to be carried out quickly.
- If you exceed time limit of the authentication process, an error message is displayed on the LCD. Press the **OK** button. When the confirmation message to print the authentication URL is displayed, try again from step 7.

▶▶ Note

- Perform the authentication process with your Google account which you have gotten in advance.

10. When message that registration is complete is displayed on printer's LCD, press **OK** button.

When authentication process is complete properly, the registration items are displayed. When authentication process is complete, you can print the data with Google Cloud Print.

Printing from Computer or Smartphone with Google Cloud Print

When you send print data with Google Cloud Print, the printer receives the print data and prints it automatically.

When printing from a smartphone, tablet, computer, or other external device by using Google Cloud Print, load paper into the printer in advance.

You can print with Google Cloud Print with the following two methods.

- Printing via internet

LAN connection with the printer and internet connection are required.

■ [Sending Print Data via Internet](#)

- Printing without going through internet

Local network connection with the printer or enabling printer's direct connection is required. Enabling Bonjour on the printer is required.

■ [Sending Print Data without Going through Internet](#)

▶▶▶ Note

- Depending on the communication status, it may take a while to print the print data or the printer may not receive the print data.
- While printing with Google Cloud Print, the printing may be canceled depending on the printer's status, such as when the printer is being operated or an error has occurred. To resume printing, check the printer's status and print with Google Cloud Print again.
- For print settings:
 - If you select the media type other than plain paper or if you select the paper size other than A4 or Letter size, the print data is printed in single-sided even when you select the duplex print setting.
 - If you select plain paper as media type or if you select B5/A5-size as paper size, the print data is printed with border even when you select the borderless print setting.
 - The print results may differ from the print image depending on the print data.
 - Depending on the device sending the print data, you may not select the print settings when sending the print data with Google Cloud Print.

Sending Print Data via Internet

This section describes the operation to send print data from Google Chrome browser on the computer. The operation differs depending on the device, applications, or services.



▶▶▶ Important

- LAN connection with the printer and internet connection are required to sending print data via internet. Internet connection fees apply.

1. [Make sure printer is turned on.](#)

»» Note

- If the printer's Auto Power On function is enabled, the printer is turned on automatically when it receives the print data.

2. Start Google Chrome browser on your computer.
3. Select **Sign in to Chrome...** from  (Chrome menu).
4. Log in to your Google account.
5. Select **Print...** from  (Chrome menu).

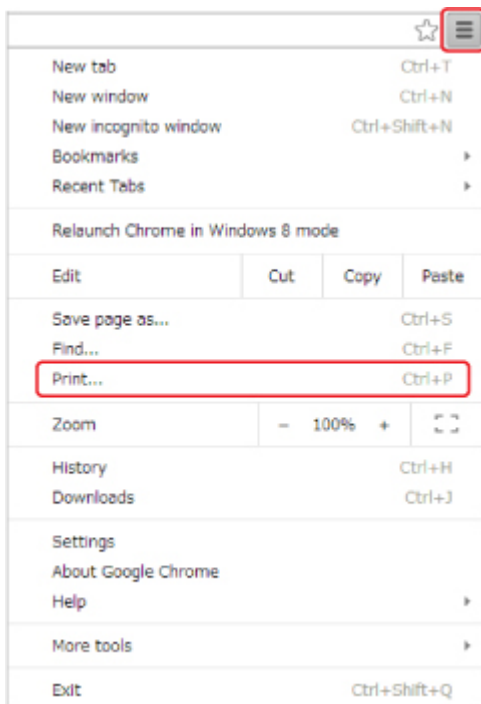

6. Select **Change...** next **Destination**.

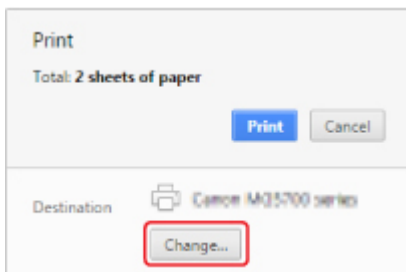

7. Select **Canon iB4100 series** in **Google Cloud Print**.
8. Select **Print**.

When the preparation for printing with Google Cloud Print is complete, the printer receives the print data and prints it automatically.

When you want to print from Google Cloud Print immediately

When the printer cannot receive the print data, or you want to start printing immediately, you can check whether there is a print job on the Google Cloud Print and start printing manually.

Follow the steps below.

1. [Make sure printer is turned on.](#)
2. Press **Setup** button.
The **Setup menu** screen is displayed.
3. Select **Web service inquiry** and press **OK** button.

▶▶▶ Note

- If you have not registered the printer with Google Cloud Print, **Web service inquiry** is not displayed.

4. Select **GoogleCloudPrint** and press **OK** button.
The confirmation screen to check is displayed.
5. Press **OK** button.
If there is the print data, the printer receives the print data and prints it.

Sending Print Data without Going through Internet

This section describes the operation to send print data from Google Chrome browser on the computer. The operation differs depending on the device, applications, or services.

▶▶▶ Important



- Local network connection with the printer or enabling printer's direct connection is required.
- Enabling Bonjour on the printer is required.

1. [Make sure printer is turned on.](#)

▶▶▶ Note

- If the printer's Auto Power On function is enabled, the printer is turned on automatically when it receives the print data.

2. Start Google Chrome browser on your computer.

3. Select **Sign in to Chrome...** from  (Chrome menu).
4. Log in to your Google account.
5. Select **Print...** from  (Chrome menu).

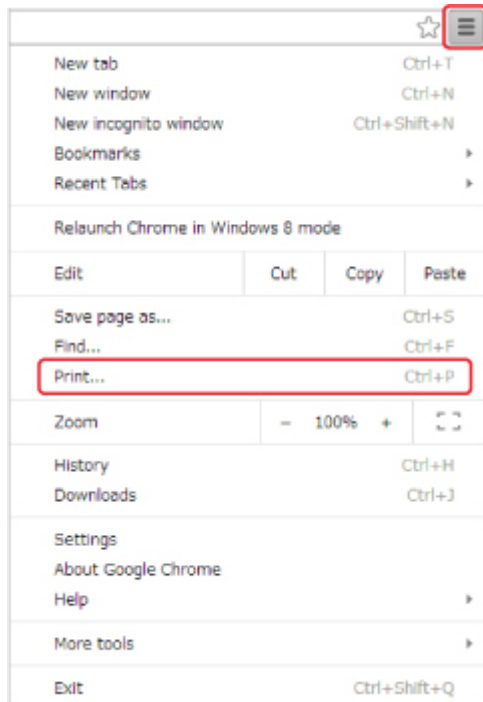

6. Select **Change...** next **Destination**.

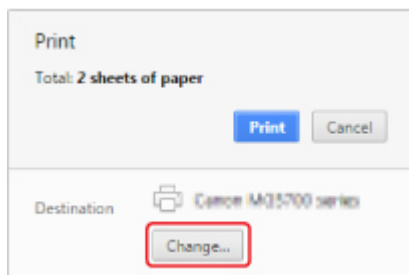

7. Select **Canon iB4100 series** in **Local Destinations**.
8. Select **Print**.

When the preparation for printing with Google Cloud Print is complete, the printer receives the print data and prints it automatically.

Deleting Printer from Google Cloud Print

If the printer's owner changes or if you want to re-register the printer, delete it from Google Cloud Print by following the steps below.

The printer can be deleted from Google Cloud Print with the following two methods.



■ [Deletion Using Google Chrome](#)

■ [Deletion Using Printer](#)

»» Important

- LAN connection with the printer and internet connection are required to delete the printer from Google Cloud Print. Internet connection fees apply.

Deletion Using Google Chrome

1. Start Google Chrome browser on your computer.
2. Select **Sign in to Chrome...** from  (Chrome menu).
3. Log in to your Google account.
4. Select **Settings** from  (Chrome menu).
5. Select **Show advanced settings...** to display information.
6. Select **Manage** for **Google Cloud Print**.
7. Select **Manage** next **Canon iB4100 series** on device list.
8. Select **Delete**.
9. When confirmation message for deleting printer appears, select **OK**.

Deletion Using Printer

»» Important

- Entering the administrator password may be required depending on the range of administrator password.

1. [Make sure printer is turned on.](#)
2. Press **Setup** button.
The **Setup menu** screen is displayed.

3. Select **Web service setup** and press **OK** button.
4. Select **GoogleCloudPrint** -> **Delete from service**.
5. When confirmation screen to delete printer is displayed, select **Yes** and press **OK** button.
6. When message that deletion is complete is displayed, press **OK** button.

Printing from an AirPrint-enabled Printer with Mac

Using AirPrint to print from your iPhone, iPad, iPod touch, or Mac.

AirPrint enables you to print photos, email, Web pages and documents from iPhone, iPad, iPod touch, and Mac without the need to install drivers, or download apps or software.

►► Note

- If you want to print using AirPrint from iOS device, see below.

■ [Printing from an AirPrint-enabled Printer with iOS Device](#)



Checking Your Environment

First, check your environment.

- **AirPrint Operation Environment**
 - iPhone, iPad, and iPod touch running the latest version of iOS
 - Mac running the latest version of Mac OS

- **Requirement**

The iOS device or Mac and the printer must be connected to the same network over a LAN or connected directly without wireless router.

Adding Printer as AirPrint Printer to Your Mac

1. Open **System Preferences**, and select **Printers & Scanners (Print & Scan)** on your Mac.
2. Select **+** to display the printer list.
3. Select the printer's name listed as **Bonjour**.
4. Select **Secure AirPrint** or **AirPrint** from **Use**.
5. Select **Add**.

Printing with AirPrint from Mac

1. [Make sure printer is turned on.](#)

▶▶▶ Note

- If the printer's Auto Power On function is enabled, the printer is turned on automatically when it receives the print data.

2. [Load paper.](#)

3. Perform printing on your application software.

Print dialog appears.

4. Select your model name added as AirPrint printer from the **Printer** list in the Print Dialog.

5. Set the paper size, media type, and other settings as needed.

6. Select **Print**.

When you execute printing, the printer prints according to the specified settings.

▶▶▶ Note

- For wireless LAN connection:
 - After you turn on the printer, it may take few minutes before the printer can communicate through a wireless LAN connection. Make sure the printer is connected to the wireless LAN and try printing.
 - If Bonjour on the printer is disabled, AirPrint cannot be used. Check the LAN settings on the printer, and enable Bonjour.
- For other AirPrint troubleshooting, see below.

■ [Cannot Print Using AirPrint](#)

Checking Print Status

- Display the Printing Status Screen

Deleting Print Job

To delete a print job with AirPrint, use one of the following two methods:

- From printer: Use **Stop** button to cancel the print job.
- From iOS device: Deleting the Undesired Print Job

Printing from a Device Equipped with Windows 10 Mobile

You can print from a device equipped with Windows 10 Mobile.

This function enables you to print photos, email, Web pages and documents from Windows 10 without the need to install drivers, or download apps or software.

Checking Your Environment

First, check your environment.

- **Operation Environment**

Windows 10

- **Requirement**

The Windows device and the printer must be connected to the same network over a LAN or connected directly without wireless router.

Adding Printer to Your Windows Device

To add the printer, refer to Windows 10 help.

Printing from Windows Device

1. [Make sure printer is turned on.](#)

▶▶▶ **Note**

- If the printer's Auto Power On function is enabled, the printer is turned on automatically when it receives the print data.

2. [Load paper.](#)

3. Select command that you perform printing on application software.

In general, select **Print** on the **File** menu to open the **Print** dialog box.

4. Select your model name.

5. Set the paper size, media type, and other settings as needed.

6. Select **Print**.

When you execute printing, the printer prints according to the specified settings.

Printing from Smartphone/Tablet

- ▶ **Printing Directly from Smartphone/Tablet**
- ▶ **Printing Using a Web Service**

Printing Directly from Smartphone/Tablet

- ▶ **Android Print**
- ▶ **Printing from an AirPrint-enabled Printer with iOS Device**
- ▶ **Printing from a Device Equipped with Windows 10 Mobile**
- ▶ **Using Printer with Direct Connection**

Android Print

You can print to a Canon printer from your Android smartphone or tablet by installing a printing plug-in.

Installing Printing Plug-in

- Installing Canon Print Service

Canon Print Service is a printing plug-in for Android 4.4.2 or later, and is available for free on Google Play. Install the plug-in and activate it.

■ [Printing Using Canon Print Service](#)

- Installing Mopria Print Service

Mopria Print Service is a plug-in that allows printing to a Mopria authentication printer from Android 4.0 or later, and is available for free on Google Play. Install the plug-in and activate it.

See the Mopria homepage (<http://www.mopria.org>) for details.

■ [Printing Using Mopria Print Service](#)

▶▶ Important

- Internet connection is required to download the printing plug-in. Internet connection fees apply.

Printing Using Canon Print Service

▶▶ Important

- The operation may differ depending on your Android device or your application.
- Activate the plug-in after installing it to your Android device. The service is not enabled immediately after installing.
- You can print using Canon Print Service with wireless LAN.

1. [Make sure printer is turned on.](#)
2. [Load paper.](#)
3. Perform print operation on your application of Android device.
4. Select printer on your application of Android device.
Select the printer that is displayed with your printer's name and "Canon Print Service".
5. Specify number of copies, paper size, etc if necessary.
6. Start printing.
When you execute printing, the printer prints according to the specified settings.

Printing Using Mopria Print Service

»» Important

- The operation may differ depending on your Android device or your application.
- Activate the plug-in after installing it to your Android device. The service is not enabled immediately after installing.
- You can print using Mopria Print Service with wireless LAN or with the printer's direct connection.

1. [Make sure printer is turned on.](#)
2. [Load paper.](#)
3. Perform print operation on your application of Android device.
4. Select printer on your application of Android device.
Select the printer that is displayed with your printer's name and "Mopria Print Service".
5. Specify number of copies, paper size, etc if necessary.
6. Start printing.
When you execute printing, the printer prints according to the specified settings.

Printing from an AirPrint-enabled Printer with iOS Device

Using AirPrint to print from your iPhone, iPad, iPod touch, or Mac.

AirPrint enables you to print photos, email, Web pages and documents from iPhone, iPad, iPod touch, and Mac without the need to install drivers, or download apps or software.

►►► Note

- If you want to print using AirPrint from Mac, see below.

■ [Printing from an AirPrint-enabled Printer with Mac](#)



Checking Your Environment

First, check your environment.

- **AirPrint Operation Environment**
 - iPhone, iPad, and iPod touch running the latest version of iOS
 - Mac running the latest version of Mac OS

- **Requirement**

The iOS device or Mac and the printer must be connected to the same network over a LAN or connected directly without wireless router.

Printing with AirPrint from iOS Device

1. [Make sure printer is turned on.](#)

►►► Note

- If the printer's Auto Power On function is enabled, the printer is turned on automatically when it receives the print data.

2. [Load paper.](#)
3. Tap operation icon to display menu options from applications of your iOS device.

The figure below is an example of when printing from the iPad web browser. The screen differs depending on the devices or applications.



4. Tap **Print** from menu options.



5. Select your model name from **Printer** on **Printer Options**.

➤➤➤ **Important**

- Because some applications do not support AirPrint, **Printer Options** may not be displayed. If an application does not let you use printer options, you cannot print from that application.

▶▶▶ Note

- **Printer Options** differ depending on the application that you are using.

6. When printing file type that has multiple pages, such as PDF file, tap **Range** and tap **All Pages** or select range of pages to be printed.
7. For **1 Copy**, tap **+** or **-** to set number of required copies.
8. For **Duplex Printing**, tap **On** to enable duplex printing or tap **Off** to disable function.
9. Tap **Print**.

When you execute printing, the printer prints according to the specified settings.

▶▶▶ Note

- For wireless LAN connection:
 - After you turn on the printer, it may take few minutes before the printer can communicate through a wireless LAN connection. Make sure the printer is connected to the wireless LAN and try printing.
 - If Bonjour on the printer is disabled, AirPrint cannot be used. Check the LAN settings on the printer, and enable Bonjour.
- For other AirPrint troubleshooting, see below.

■ [Cannot Print Using AirPrint](#)

Paper Size

With AirPrint, the paper size is selected automatically according to the application being used on the iOS device and the region in which AirPrint is used.

When you use the photo application, the default paper size is L size in Japan, and 4"x6" or KG in other countries and regions.

When you use the document application, the default paper size is letter size in the U.S. region, and A4 in Japan and Europe.

▶▶▶ Important

- Depending on the device or operation system, the default paper size is different from above size.
We recommend you perform test printing.
- Your application may support different paper sizes.

Printing of Envelopes

For printing on the envelope from iOS device with AirPrint, refer to the following.

Print result image	Orientation of print data	Orientation of loading envelope
--------------------	---------------------------	---------------------------------

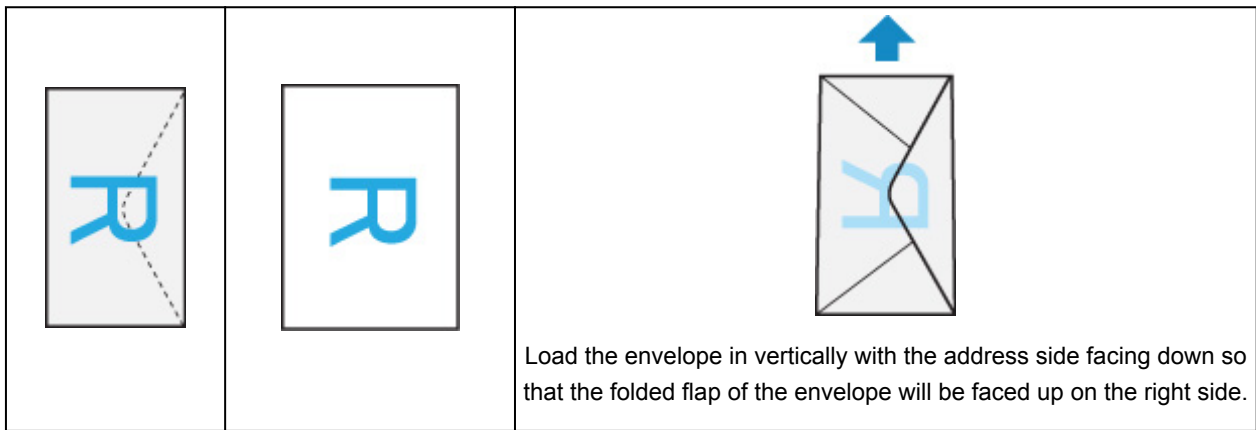

Checking Print Status

During printing, a **Print Center** icon is displayed in the list of recently used applications and you can use it to check the print progress.

Press the Home button on the iOS device twice to set the **Multitasking** mode. Then swipe to the right to display the **Print Center** icon and a **Print Summary**.

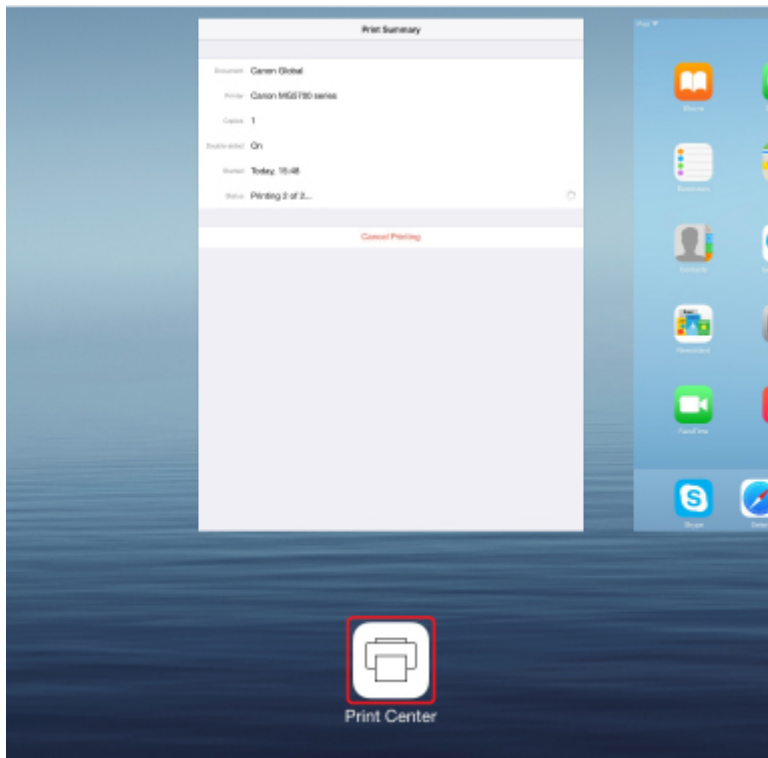

Deleting Print Job

To delete a print job with AirPrint, use one of the following two methods:

- From printer: Use **Stop** button to cancel the print job.
- From iOS device: Press the Home button on the iOS device twice to set the **Multitasking** mode and swipe to the right. Tap the **Print Center** icon to display a **Print Summary**. Tap the print job to be canceled and tap **Cancel Printing**.

Using Printer with Direct Connection

You can connect devices (e.g. smartphone or tablet) to the printer by two methods below.

- Wireless connection (connecting devices via a wireless router)
- Direct wireless connection (connecting devices using direct connection)

This section describes direct connection, which allows you to print by connecting the devices to the printer directly.

Follow the procedure below to use direct connection.

1. [Enable direct connection.](#)
2. [Connect devices to printer.](#)
3. [Perform printing operation.](#)

This section also describes changing direct connection to wireless LAN.

■ [Changing Printer Setting to Use Wireless LAN](#)

▶▶▶ Important

- You can connect up to 5 devices to the printer at the same time.
- Check the usage restrictions and switch the printer to the direct connection.

■ Restrictions

Preparing for Direct Connection

Change settings below to prepare for direct connection.

- Printer's LAN settings
 - [Changing Printer's Settings](#)
- Settings of a device to connect
 - [Changing Settings of a Device and Connecting It to the Printer](#)

Changing Printer's Settings

1. [Make sure printer is turned on.](#)
2. Press **Setup** button.
The **Setup menu** screen is displayed.
3. Select **Device settings** and press **OK** button.
The **Device settings** screen is displayed.
4. Select **LAN settings** and press **OK** button.
5. Select **Change LAN** and press **OK** button.

6. Select **Direct connection** and press **OK** button.

7. Select **Yes** and press **OK** button.

▶▶▶ Note

- Check the following items on **Wireless router info**. Use the ◀▶ button to display details.

- Identifier (SSID)
- Security setting and password
- Printer's name which appears on a Wi-Fi Direct compatible device

The password is required when connecting a device to the printer. Depending on the device you are using, no password is required.

When you connect a Wi-Fi Direct compatible device to the printer, select the device name displayed on the LCD from your device.

- The identifier (SSID) and the security setting are specified automatically. To update them, see below.

■ [Changing Direct Connection Setting](#)

8. Select **Done** and press **OK** button.

The direct connection is enabled and a device can be connected to the printer wirelessly.

Changing Settings of a Device and Connecting It to the Printer

1. Turn on wireless communication on your device.

Enable "Wi-Fi" on your device's "Setting" menu.

For more on turning on wireless communication, see your device's instruction manual.

2. Select "DIRECT-XXXX-iB4100series" ("X" represents alphanumeric character.) from list displayed on device.

▶▶▶ Note

- If "DIRECT-XXXX-iB4100series" does not appear on the list, direct connection is not enabled.

See [Changing Printer's Settings](#) to enable direct connection.

3. Enter password.

Your device is connected to the printer.

▶▶▶ Note

- Check the password for the direct connection.

Check by one of the following methods.

- Display on the LCD.

■ [LAN settings](#)

- Print the network settings.

■ [Printing Network Settings](#)

- Depending on the device you are using, entering the password is required to connect a device to the printer via wireless LAN. Enter the password specified for the printer.
- If your Wi-Fi Direct compatible device is set to prioritize using Wi-Fi Direct and it is connecting to the printer, the printer displays a confirmation screen asking if you allow the device to connect to the printer.

Make sure the name on the LCD is the same as that of your wireless communication device, select **Yes**, and then press the **OK** button.

Printing with Direct Connection

Connect a device and the printer and start printing from the device.

▶▶▶ Note

- For more on printing from a device via wireless LAN, refer to the device's or application's instruction manual.
- You can print from your smartphone or tablet by installing Canon PRINT Inkjet/SELPHY. Download it from App Store and Google Play.

■ For iOS

■ For Android

Changing Printer Setting to Use Wireless LAN

Follow the procedure below to change the printer setting to use wireless LAN.

1. Press **Setup** button.

The **Setup menu** screen is displayed.

2. Select **Device settings** and press **OK** button.

3. Select **LAN settings** and press **OK** button.

4. Select **Change LAN** and press **OK** button.

5. Select **Wireless LAN** and press **OK** button.

If you do not use the printer over wireless LAN, select **Wired LAN** or **LAN inactive**.

Changing Direct Connection Setting

Change the settings for the direct connection following the procedure below.

1. [Make sure printer is turned on.](#)

2. Press **Setup** button.
The **Setup menu** screen is displayed.
3. Select **Device settings** and press **OK** button.
The **Device settings** screen is displayed.
4. Select **LAN settings** and press **OK** button.
5. Select **Direct connection** and press **OK** button.
6. Select an item and press **OK** button.

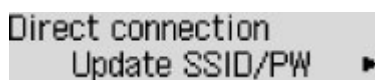

- **Update SSID/PW**

Update the identifier (SSID) and the password for direct connection.

When the confirmation screen appears, select **Yes** and press the **OK** button to update the identifier (SSID) and the password.

Selecting **SSID** on the **Wireless router info** and pressing the **OK** button shows the updated identifier (SSID).

- **Confirm request**

Change the confirmation screen setting when a Wi-Fi Direct compatible device is connecting to the printer.

Pressing the **OK** button displays the confirmation screen. If you want the printer to display the screen to inform you a Wi-Fi Direct device is connecting to the printer, select **Yes** and press the **OK** button.

»»» Important

- To prevent an unauthorized access, we recommended you should not change the setting from the default.

»»» Note

- If you change the direct connection setting of the printer, also change the wireless router setting of the device.

Printing Using a Web Service

- ▶ **Using PIXMA/MAXIFY Cloud Link**
- ▶ **Printing with Google Cloud Print**

Using PIXMA/MAXIFY Cloud Link

By using PIXMA/MAXIFY Cloud Link, you can connect your printer to a cloud service, such as CANON IMAGE GATEWAY, Evernote, or Twitter, and use the following functions without using a computer:

- Print images from a photo-sharing service
- Print documents from a data management service
- Save scanned images to a data management service.
- Use Twitter to report the printer status, such as no paper or low ink levels.

In addition, you can use various functions by adding and registering apps that are linked with various cloud services.

■ Using PIXMA/MAXIFY Cloud Link from Your Printer

■ [Using PIXMA/MAXIFY Cloud Link from Your Smartphone, Tablet, or Computer](#)



▶▶▶ Important

- In certain countries, PIXMA/MAXIFY Cloud Link may not be available or the available apps may be different.
- Some apps require that you have an account before you use those apps. For such apps, please set up an account beforehand.
- To find out which models support PIXMA/MAXIFY Cloud Link check the Canon homepage.
- The screen display may change without prior notice.

Printing with Google Cloud Print

The printer is compatible with Google Cloud Print™ (Google Cloud Print is a service provided by Google Inc.).

By using Google Cloud Print, you can print from anywhere with applications or services supporting Google Cloud Print.

Sending Print Data and Printing via Internet



Once you register the printer to Google Cloud Print, you can print from applications or services supporting Google Cloud Print without internet connection.

Sending Print Data and Printing without Going through Internet



»» Important

- This function may not be available depending on the country or region you live in.
- To use Google Cloud Print, you need to get Google account and register the printer with Google Cloud Print in advance.

Additionally, LAN connection with the printer and internet connection are required to register the printer to Google Cloud Print. Internet connection fees apply.

1. [Getting Google Account](#)
2. [Registering Printer with Google Cloud Print](#)
3. [Printing from Computer or Smartphone with Google Cloud Print](#)

»» Important

- When the printer owner changes, delete its registration from Google Cloud Print.

■ [Deleting Printer from Google Cloud Print](#)

LAN connection with the printer and internet connection are required to delete the printer from Google Cloud Print. Internet connection fees apply.

Paper Settings

By registering the paper size and the media type loaded in the cassette, you can prevent the printer from misprinting by displaying the message before printing starts when the paper size or the media type of the loaded paper differs from the print settings.

▶▶▶ Note

- The default display setting is different between when you print from the operation panel of the printer and when you print using the printer driver.

■ [Default Setting for Displaying the Message which Prevents Misprinting](#)

- **When you insert the cassette with paper loaded:**

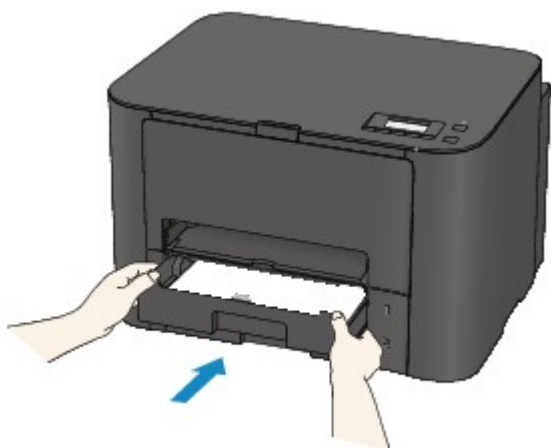

The screen to register the cassette paper information is displayed.

Register cassette 1 pape
[OK]Next

Size: ◀ *A4 ▶
Type: *Plain paper

Register the paper size and the media type according to the loaded paper.

▶▶▶ Important

- For more on the proper combination of paper settings you can specify by the printer driver or on the LCD:
 - For Windows:
 - [Paper Settings on the Printer Driver and the Printer \(Media Type\)](#)
 - [Paper Settings on the Printer Driver and the Printer \(Paper Size\)](#)
 - For Mac OS:
 - Paper Settings on the Printer Driver and the Printer (Media Type)
 - Paper Settings on the Printer Driver and the Printer (Paper Size)

- **When the paper settings for printing are different from the cassette paper information registered to the printer:**

Ex:

- Paper setting for printing: B5
- Cassette paper information registered to the printer: A4

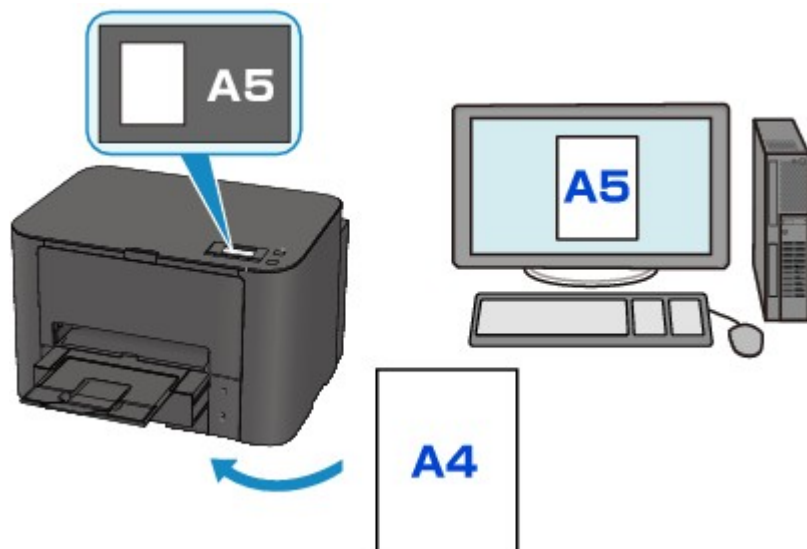

When you start printing, a message is displayed.

Pressing the **OK** button displays the paper setting specified for printing under the message.

```
Size/type of paper 2111
[OK]Select option
```

Check the message and press the **OK** button. When the screen to select the operation is displayed, select one of the operations below.

▶▶▶ Note

- Depending on the setting, the choices below may not be displayed.

Use cass. settings

Select if you want to print on the paper loaded in the rear tray without changing the paper settings.

For example, when the paper setting for printing is A5 and the rear tray paper information registered to the printer is A4, the printer starts printing with A5 on the paper loaded in the rear tray.

Replace the paper

Select if you want to print after replacing the paper of the cassette.

For example, when the paper setting for printing is A5 and the cassette paper information registered to the printer is A4, you load A5 sized paper in the cassette before you start printing.

The cassette paper information registration screen is displayed after replacing the paper and inserting the cassette. Register the cassette paper information according to the paper you loaded in the cassette.

▶▶▶ Note

- If you do not know what paper information to register to the printer, press the **Back** button when the screen to select the operation is displayed. When the previous screen is displayed, check the paper size and the media type and register them to the printer.
- For more on the proper combination of paper settings you can specify by the printer driver or on the LCD:
 - For Windows:
 - [Paper Settings on the Printer Driver and the Printer \(Media Type\)](#)
 - [Paper Settings on the Printer Driver and the Printer \(Paper Size\)](#)
 - For Mac OS:
 - Paper Settings on the Printer Driver and the Printer (Media Type)
 - Paper Settings on the Printer Driver and the Printer (Paper Size)

Cancel

Cancels printing.

Select when you change the paper settings specified for printing. Change the paper settings and try printing again.

Default Setting for Displaying the Message which Prevents Misprinting

◦ When you print using the operation panel of the printer:

The message which prevents misprinting is enabled by default.

To change the display setting when you print using the operation panel of the printer:

- [Cassette settings](#)

◦ When you print using the printer driver:

The message which prevents misprinting is disabled by default.

To change the display setting when you print using the printer driver:

- For Windows:
 - [Changing the Printer Operation Mode](#)
- For Mac OS:
 - Changing the Printer Operation Mode

▶▶▶ Important

• When the message which prevents misprinting is disabled:

The printer starts printing even though the paper settings for printing and the cassette paper information registered to the printer are different.

Using PIXMA/MAXIFY Cloud Link

By using PIXMA/MAXIFY Cloud Link, you can connect your printer to a cloud service, such as CANON IMAGE GATEWAY, Evernote, or Twitter, and use the following functions without using a computer:

- Print images from a photo-sharing service
- Print documents from a data management service
- Save scanned images to a data management service.
- Use Twitter to report the printer status, such as no paper or low ink levels.

In addition, you can use various functions by adding and registering apps that are linked with various cloud services.

■ Using PIXMA/MAXIFY Cloud Link from Your Printer

■ [Using PIXMA/MAXIFY Cloud Link from Your Smartphone, Tablet, or Computer](#)



▶▶▶ Important

- In certain countries, PIXMA/MAXIFY Cloud Link may not be available or the available apps may be different.
- Some apps require that you have an account before you use those apps. For such apps, please set up an account beforehand.
- To find out which models support PIXMA/MAXIFY Cloud Link check the Canon homepage.
- The screen display may change without prior notice.

Troubleshooting

Frequently Asked Questions

- [Cannot Find Printer on Network](#)
- [Cannot Find Printer while Using Wireless LAN](#)
- [Printing Does Not Start](#)
- [Paper Is Blank/Printing Is Blurry/Colors Are Wrong/White Streaks Appear](#)
- [An Error Occurs](#)
- [Print Results Are Unsatisfactory](#)
- [Message Appears](#)
- [Cannot Install Printer Driver](#)
- [Network Key Unknown](#)
- [Paper Jams](#)
- [List of Support Code for Error](#)

Examples of Problems

- **Printer Does Not Move**
 - [Power Does Not Come On](#)
 - [Power Shuts Off By Itself](#)
 - [Printer Suddenly Cannot Be Used](#)
 - [Printing Does Not Start](#)
 - [Paper Jams](#)
 - [Cannot Print from Smartphone/Tablet](#)
 - [Cannot Print Using AirPrint](#)
- **Cannot Set Correctly**
 - [Cannot Find Printer on Check Printer Settings Screen](#)
 - [Message Appears on Computer During Setup](#)
 - [Cannot Find Printer while Using Wireless LAN](#)
 - [Cannot Find Printer while Using Wired LAN](#)
 - [USB Connection Problems](#)
 - [Cannot Communicate with Printer via USB](#)
 - [Network Key Unknown](#)
 - [Printer Cannot Be Used After Replacing Wireless Router or Changing Its Settings](#)
 - [Administrator Password Set for Printer Unknown](#)
 - [Checking Network Information](#)
 - [Restoring to Factory Defaults](#)
 - [Cannot Install Printer Driver](#)
 - [Easy-WebPrint EX Does Not Start or Easy-WebPrint EX Menu Does Not Appear \(Windows\)](#)
 - [Updating Printer Driver in Network Environment \(Windows\)](#)
- **Print Results Are Unsatisfactory**
 - [Printing Does Not Start](#)

- [Printing Is Slow](#)
- [Printing Stops](#)
- [Print Results Are Unsatisfactory](#)
- [No Ink Comes Out](#)
- [Paper Jams](#)
- [Paper Does Not Feed Properly/"No Paper" Error](#)
- [Automatic Duplex Printing Problems](#)

- **Error or Message Appears**
 - [An Error Occurs](#)
 - [LCD Is Off](#)
 - [LCD Shows Wrong Language](#)
 - [Message Appears](#)
 - [List of Support Code for Error](#)

Operation Problems

- [Network Communication Problems](#)
- [Printing Problems](#)
- [Problems while Printing from Smartphone/Tablet](#)
- [Mechanical Problems](#)
- [Installation and Download Problems](#)
- [Errors and Messages](#)
- [If You Cannot Solve a Problem](#)

Network Communication Problems

- ▶ **Cannot Find Printer on Network**
- ▶ **Network Connection Problems**
- ▶ **Other Network Problems**

Cannot Find Printer on Network

While performing printer setup:

- ▶ **Cannot Find Printer on Check Printer Settings Screen**
- ▶ **Cannot Find Printer after Searching it on Printer Detection Screen During Setup**
- ▶ **Searching Printer by IP Address or Host Name During Setup (Windows)**
- ▶ **Cannot Proceed beyond Printer Connection Screen/Connect Cable Screen**

While using printer:

- ▶ **Cannot Find Printer while Using Wireless LAN**
- ▶ **Cannot Find Printer while Using Wired LAN**

▶▶ Note

- You cannot use the wireless LAN and the wired LAN at the same time.

Cannot Find Printer on Check Printer Settings Screen

- **For Windows:**

If the printer cannot be found and the **Check Printer Settings** screen appears after searching the printer by **Automatic search** on the **Search for Printers** screen, click **Redetect** and search for the printer again by the IP address on the **Search for Printers** screen.

If the printer has not been found after searching it by the IP address, check network settings.

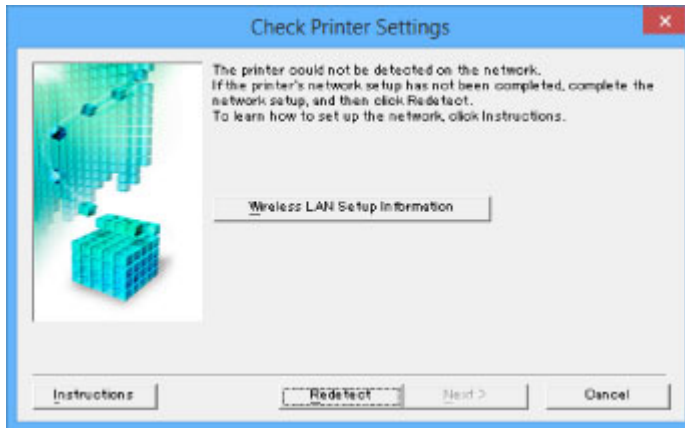

- **For Mac OS:**

If the printer cannot be found on the **Check Printer Settings** screen, check network settings before redetecting the printer.

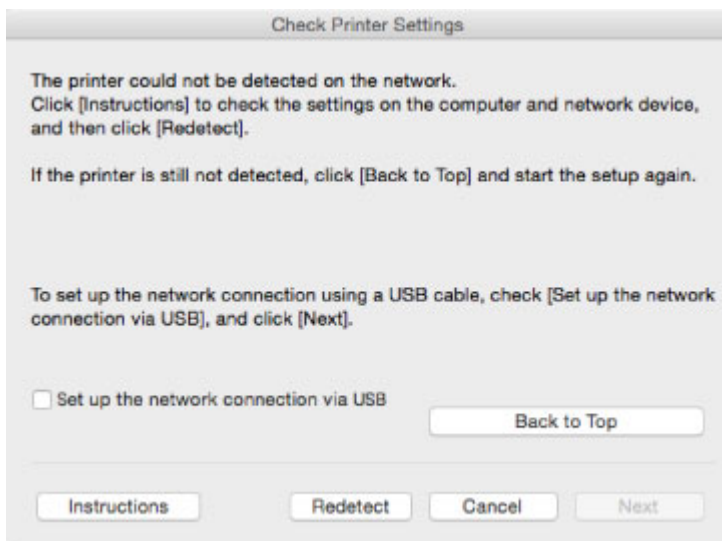

■ [Check 1: Cannot Find Printer on Check Printer Settings Screen During Wireless LAN Setup](#)

■ [Check 1: Cannot Find Printer on Check Printer Settings Screen During Wired LAN Setup](#)



Check 1: Cannot Find Printer on Check Printer Settings Screen During Wireless LAN Setup



Are printer and network device (router, etc.) turned on?

Make sure the printer is turned on.

■ [Confirming that the Power Is On](#)

Make sure network device (router, etc.) is turned on.

If printer or network device is off:

Turn on printer or network device.

It may take a while for the printer and network device to become ready for use once they are turned on.

Wait a while after turning on the printer or network device, and then click **Redetect** on the **Check Printer Settings** screen to redetect the printer.

If the printer is found, follow the instructions on the screen to continue to set up network communication.

If printer and network device are on:

If the network devices are on, turn them off and on again. If the printer cannot be found after that, go to Check 2.

■ [Check 2: Cannot Find Printer on Check Printer Settings Screen During Wireless LAN Setup](#)



Check 2: Cannot Find Printer on Check Printer Settings Screen During Wireless LAN Setup



Is printer set to allow wireless communication?

Make sure the  or  icon is displayed on the LCD.



If icon is not displayed:

- For Windows:

The printer is not set to allow wireless communication. Click **Wireless LAN Setup Information** on the **Check Printer Settings** screen to check the status and turn on wireless communication on the printer.

- For Mac OS:

The printer is not set to allow wireless communication. Turn on wireless communication on the printer. After enabling the wireless LAN setting, click **Back to Top** on the **Check Printer Settings** screen to try to set up the network communication from the beginning.

If icon is displayed:

Go to check 3.

- [Check 3: Cannot Find Printer on Check Printer Settings Screen During Wireless LAN Setup](#)



Check 3: Cannot Find Printer on Check Printer Settings Screen During Wireless LAN Setup



Is printer connected to wireless router?

Use the icon on the LCD to make sure the printer is connected to the wireless router.



If icon is displayed:

- Checking wireless router location

After checking the wireless router setting, make sure the printer is not placed far away from the wireless router.

The printer can be up to 50 m (164 ft) from the wireless router indoors. Make sure the printer is close enough to the wireless router to be used.

Place the wireless router and printer where there are no obstacles between them. Wireless communication between different rooms or floors is generally poor. Wireless communication can be impeded by building materials containing metal or concrete. If the printer cannot communicate with the computer over a wireless LAN due to a wall, place the printer and the computer in the same room.

In addition, if a device like a microwave oven that emits radio waves of the same frequency bandwidth as a wireless router is nearby, it may cause interference. Place the wireless router as far away from interference sources as possible.

- Checking wireless router settings

The printer and wireless router should be connected using 2.4 GHz bandwidth. Make sure the wireless router for the printer's destination is configured to use 2.4 GHz bandwidth.

Check the SSID of the wireless router for the printer by printing out the network settings information using the operation panel.

■ [Printing Network Settings](#)

For more on the wireless router, refer to the instruction manual supplied with the wireless router or contact its manufacturer.

After taking measures above, click **Redetect** on the **Check Printer Settings** screen to redetect the printer.

If the printer is found, follow the instructions on the screen to continue to set up network communication.

If the printer cannot be detected, the printer is not connected to the wireless router. Connect the printer to the wireless router.

After connecting the printer to the wireless router, set up the network communication from the beginning.

If  icon is displayed:

Go to check 4.

- [Check 4: Cannot Find Printer on Check Printer Settings Screen During Wireless LAN Setup](#)



Check 4: Cannot Find Printer on Check Printer Settings Screen During Wireless LAN Setup



Is printer's IP address specified correctly?

If printer's IP address is not specified correctly, the printer may not be found. Make sure whether printer's IP address is not used for another device.

To check the printer's IP address, print out the network settings information using the operation panel.

■ [Printing Network Settings](#)

If the IP address is not specified correctly:

See [If an error screen appears](#): and specify the IP address.

If the IP address is specified correctly:

Go to check 5.

■ [Check 5: Cannot Find Printer on Check Printer Settings Screen During Wireless LAN Setup](#)



Check 5: Cannot Find Printer on Check Printer Settings Screen During Wireless LAN Setup



Disable block in firewall function temporarily.

The firewall of your security software or operation system for computer may limit communication between the printer and your computer. Check the firewall setting of your security software or operation system or the message shown on your computer and disable block temporarily.

If firewall interferes with setup:

- **If message appears:**

If a message appears warning that Canon software is attempting to access the network, set the security software to allow access.

After allowing the software to access, click **Redetect** on the **Check Printer Settings** screen to redetect the printer.

If the printer is found, follow the instructions on the screen to continue to set up the network communication.

- **If no message appears:**

Cancel the setup, and then set the security software to allow Canon software below to access the network.

- For Windows:

Setup.exe or **Setup64.exe** in the **win > Driver > DrvSetup** folder on the Setup CD-ROM

- For Mac OS:

Setup.app, **Canon IJ Network Tool.app**, **canonijnetwork.bundle**, **CIJScannerRegister.app**, **Canon IJ Scan Utility2.app**, and **CIJSUAgent.app**

After setting the security software, redo the network communication setup from the beginning.

After setup is completed, enable firewall.

▶▶ Note

- For more on firewall settings of your operating system or security software, see instruction manual or contact its manufacturer.

If firewall settings are not causing problem:

Go to check 6.

- [Check 6: Cannot Find Printer on Check Printer Settings Screen During Wireless LAN Setup](#)



Check 6: Cannot Find Printer on Check Printer Settings Screen During Wireless LAN Setup



Check wireless router settings.

Check wireless router network connection settings, such as IP address filtering, MAC address filtering, and DHCP function.

Make sure the same radio channel is assigned to the wireless router and the printer.

To check the settings of the wireless router, see the instruction manual supplied with the wireless router or contact the manufacturer.

After checking the wireless router settings, click **Redetect** on the **Check Printer Settings** screen to redetect the printer.

If the printer is found, follow the instructions on the screen to continue to set up network communication.



Check 1: Cannot Find Printer on Check Printer Settings Screen During Wired LAN Setup



Is LAN cable connected, and are printer and router on?

Make sure the LAN cable is connected.

Make sure the printer is turned on.

■ [Confirming that the Power Is On](#)

Make sure the router is turned on.

If LAN cable is connected and printer or network device is off:

Turn on printer or network device.

It may take a while for the printer and network device to become ready for use once they are turned on.

Wait a while after turning on the printer or network device, and then click **Redetect** on the **Check Printer Settings** screen to redetect the printer.

If the printer is found, follow the instructions on the screen to continue to set up the network communication.

If LAN cable is connected and printer and network device are on:

If the printer cannot not be found after trying to redetect it, even though the printer and the network device are on, go to Check 2.

■ [Check 2: Cannot Find Printer on Check Printer Settings Screen During Wired LAN Setup](#)



Check 2: Cannot Find Printer on Check Printer Settings Screen During Wired LAN Setup



Can you view any web pages on your computer?

Make sure the computer and network device (router, etc.) are configured and the computer is connected to the network.

If you cannot view any web pages:

Click **Cancel** on the **Check Printer Settings** screen to cancel to set up the network communication.

After that, configure the computer and network device.

For the procedures, refer to the instruction manuals supplied with the computer and network device, or contact their manufacturers.

If you can view web pages after configuring the computer and network device, try to set up the network communication from the beginning.

If you can view web pages:

Go to check 3.

- [Check 3: Cannot Find Printer on Check Printer Settings Screen During Wired LAN Setup](#)



Check 3: Cannot Find Printer on Check Printer Settings Screen During Wired LAN Setup



Is printer set to allow wired communication?

Make sure the  icon is displayed on the LCD.



If icon is not displayed:

The printer is not set to allow wired communication. Turn on wired communication on the printer.

Once you have turned on wired communication, redo the network communication setup from the beginning.

If icon is displayed:

Go to check 4.

- [Check 4: Cannot Find Printer on Check Printer Settings Screen During Wired LAN Setup](#)



Check 4: Cannot Find Printer on Check Printer Settings Screen During Wired LAN Setup



Is printer's IP address specified correctly?

If printer's IP address is not specified correctly, the printer may not be found. Make sure whether printer's IP address is not used for another device.

To check the printer's IP address, print out the network settings information using the operation panel.

■ [Printing Network Settings](#)

If the IP address is not specified correctly:

See [If an error screen appears](#): and specify the IP address.

If the IP address is specified correctly:

Go to check 5.

■ [Check 5: Cannot Find Printer on Check Printer Settings Screen During Wired LAN Setup](#)



Check 5: Cannot Find Printer on Check Printer Settings Screen During Wired LAN Setup



Disable block in firewall function temporarily.

The firewall of your security software or operation system for computer may limit communication between the printer and your computer. Check the firewall setting of your security software or operation system or the message shown on your computer and disable block temporarily.

If firewall interferes with setup:

- **If message appears:**

If a message appears warning that Canon software is attempting to access the network, set the security software to allow access.

After allowing the software to access, click **Redetect** on the **Check Printer Settings** screen to redetect the printer.

If the printer is found, follow the instructions on the screen to continue to set up the network communication.

- **If no message appears:**

Cancel the setup, and then set the security software to allow Canon software below to access the network.

- For Windows:

Setup.exe or **Setup64.exe** in the **win > Driver > DrvSetup** folder on the Setup CD-ROM

- For Mac OS:

Setup.app, **Canon IJ Network Tool.app**, **canonijnetwork.bundle**, **CIJScannerRegister.app**, **Canon IJ Scan Utility2.app**, and **CIJSUAgent.app**

After setting the security software, redo the network communication setup from the beginning.

After setup is completed, enable firewall.

▶▶ Note

- For more on firewall settings of your operating system or security software, see instruction manual or contact its manufacturer.

If firewall settings are not causing problem:

Go to check 6.

- [Check 6: Cannot Find Printer on Check Printer Settings Screen During Wired LAN Setup](#)



Check 6: Cannot Find Printer on Check Printer Settings Screen During Wired LAN Setup



Check router settings.

Check router network connection settings such as IP address filtering, MAC address filtering, and DHCP function.

For more on checking the settings of the router, refer to the instruction manual supplied with the router or contact its manufacturer.

After checking the router settings, click **Redetect** on the **Check Printer Settings** screen to redetect the printer.

If the printer is found, follow the instructions on the screen to continue to set up network communication.



Cannot Find Printer after Searching it on Printer Detection Screen During Setup



- **For Windows:**

The printer could not be detected with the current setup method.

Select **Set up the network connection according to the guide** radio button and click **Next**. The screen to show another setup method is displayed.

Canon PRO iXXX series

1 2 3 4

Select Printer

Select from the list
The serial number can be found on the Letter of Guarantee and on the printer.

IPv4 Address IPv6 Address

Serial Number	IP Address	MAC Address
---------------	------------	-------------

Serial Number Location Update

Specify the IP address and run the search

Set up the network connection according to the guide.
Select this option if the printer is not displayed on the list or if it cannot be found by specifying the IP address.

Back to Top Next

Perform setup following the instructions on the screen.

►►► Note

- You can search for printers by an IP address or host name.

■ [Searching Printer by IP Address or Host Name During Setup \(Windows\)](#)

- **For Mac OS:**

The printer could not be detected with the current setup method.

Select the **Setting printer could not be found on the list** check box and click **Next**. The screen to show another setup method is displayed.

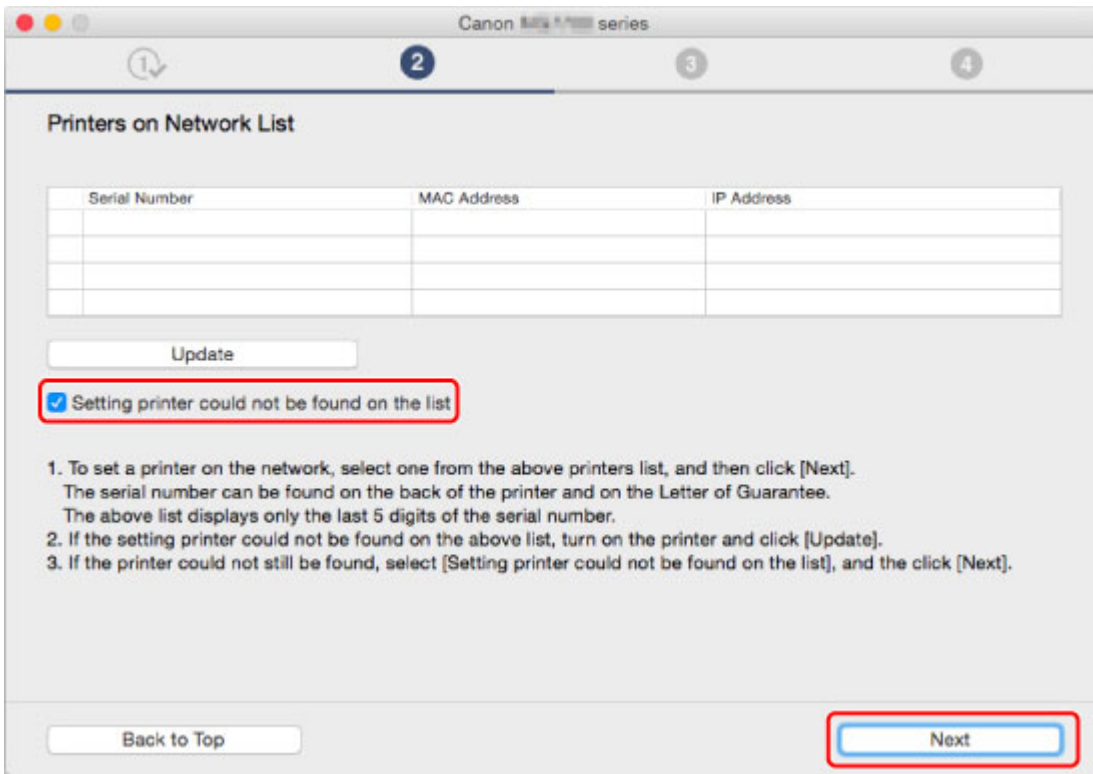

Perform setup following the instructions on the screen.

Searching Printer by IP Address or Host Name During Setup (Windows)

If the printer cannot be found on the **Select Printer** screen, search for the printer by an IP address or host name. Select **Specify the IP address and run the search** radio button and click **Next**. The screen to select searching criteria appears.

1. Check printer's IP address or host name.

To check the printer's IP Address or host name, print out the network settings information using the operation panel.

■ [Printing Network Settings](#)

▶▶▶ Note

- If you use the printer in an office, ask the network administrator.

2. Specify searching method.

Select one of the method below.

The screenshot shows the 'Printer Search Method Selection' screen. It features three radio button options, each with a text input field below it:

- Search by IPv4 address (Input field 1)
- Search by IPv6 address (Input field 2)
- Search by host name (Input field 3)

At the bottom of the screen, there are three buttons: 'Back', 'Next', and 'Online Manual'. A progress indicator at the top shows step 2 is active.

1. **Search by IPv4 address**

Select to search for printers by IPv4 address.

2. **Search by IPv6 address**

Select to search for printers by IPv6 address.

3. **Search by host name**

Select to search for printers by host name. A host name is referred to as LLMNR host name or Bonjour name.

3. Enter IP address or host name and click **Next**.

Printer search starts.

If an error screen appears:

Resolve the error according to the instruction on the screen.

If the IP address you entered is already used for another device, specify printer's IP address again using IJ Network Device Setup Utility.

►► Important

- If firewall is enabled on the computer, printers on a different subnet may not be detected. Disable firewall.

If firewall interferes with printer search:

- **If message appears:**

If a message appears warning that Canon software is attempting to access the network, set the security software to allow access.

After allowing the software to access, specify the IP address or host name and search for printers again.

If the printer is found, follow the instructions on the screen to continue to set up the network communication.

- **If no message appears:**

Cancel searching printers, and then set the security software to allow Canon software below to access the network.

Setup.exe or **Setup64.exe** in the **win > Driver > DrvSetup** folder on the Setup CD-ROM

After setting the security software, specify the IP address or host name and search for printers again.

►► Note

- For more on firewall settings of your operating system or security software, see instruction manual or contact its manufacturer.



Cannot Proceed beyond Printer Connection Screen/Connect Cable Screen



If you cannot proceed beyond the **Printer Connection** screen or the **Connect Cable** screen, check the following.

Check1 Make sure USB cable is securely plugged in to printer and computer.

Connect the printer and the computer using a USB cable as the illustration below. The USB port is located at the back of the printer.

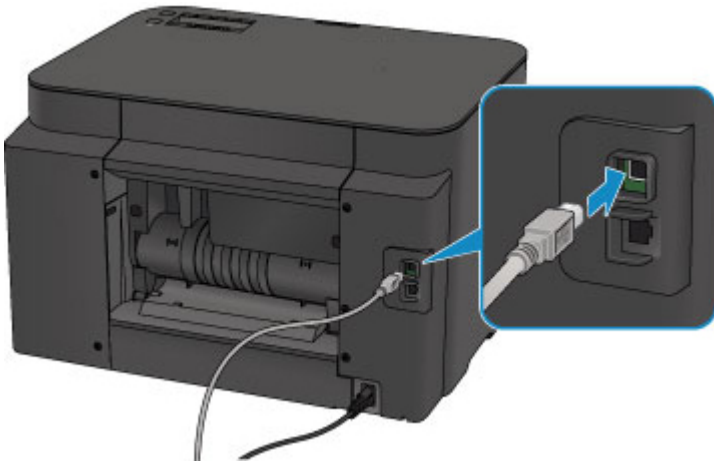

Check the items below only if you cannot proceed beyond the **Printer Connection** screen.

Check2 Follow procedure below to connect printer and computer again.

»» Important

- For Mac OS, make sure the lock icon is on the lower left of the **Printers & Scanners** screen (**Print & Scan** screen in Mac OS X v10.8 or Mac OS X v10.7).

If the  icon (locked) is displayed, click the icon to unlock. (The administrator name and the password are necessary to unlock.)

1. Turn off printer.
2. Unplug USB cable from printer and computer and connect it again.
3. Turn on printer.

Check3 If you cannot resolve problem, follow procedure below to reinstall the printer driver.

- For Windows:

1. Click **Cancel**.
 - If the **Installation Failure** screen appears:
 1. Click **Start Over**.
 2. Click **Exit** on **Start Setup** screen and finish setup.
 - If the **Connection failed.** screen appears:
 1. Click **Next**.
 2. Click **Next** on displayed screen.
 3. Click **Back to Top** on **Select Printer** screen.
 4. Click **Exit** on **Start Setup** screen and finish setup.
3. Turn off printer.
4. Restart computer.
5. Make sure you have no application software running.
6. Redo setup according to instructions on Canon website.

▶▶▶ Note

- You can use the Setup CD-ROM to redo setup.

- For Mac OS:
 1. Click **Next**.
 2. Click **Exit** on displayed screen and finish setup.
 3. Turn off printer.
 4. Restart computer.
 5. Make sure you have no application software running.
 6. Redo setup according to instructions on Canon website.



Cannot Find Printer while Using Wireless LAN



Check1 Make sure the printer is turned on.

Check2 Is  icon displayed on LCD?

If the icon is not displayed, select **Wireless LAN** on **Change LAN** in **LAN settings** under **Device settings**.

Check3 If printer is temporarily connected to computer via USB cable, make sure USB cable is connected properly.

If you set up the wireless LAN connection or change the wireless LAN settings over a USB connection, connect the printer and the computer using a USB cable as the illustration below. The USB port is at the side of the printer.

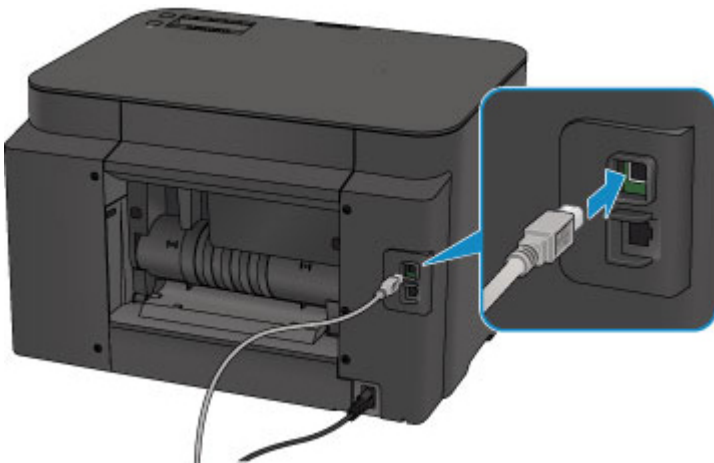



Check4 Make sure printer setup is complete.

If it is not, perform setup.

- For Windows:
Use the Setup CD-ROM or follow the instructions on the Canon website.
- For Mac OS:
Follow the instructions on the Canon website.

Check5 Look for printer again.

- For Windows:
 [IJ Network Device Setup Utility Screen](#)
- For Mac OS:
 Canon IJ Network Tool Screen

Check6 Make sure printer and wireless router network settings match.

Make sure the network settings of the printer (e.g. wireless router name, SSID, network key, etc.) are identical with those of the wireless router.

To check the settings of the wireless router, refer to the instruction manual provided with it or contact its manufacturer.

To check the current network settings of the printer, print out the network setting information.

■ [Printing Network Settings](#)

If the printer network settings do not match with those of the wireless router, change the network settings of the printer to match with those of the wireless router.

■ [Network Settings \(IJ Network Device Setup Utility\) \(Windows\)](#)

■ Network Communication (Mac OS)

Check7 Make sure the printer is not placed too far away from the wireless router.

Place the wireless router and printer where there are no obstacles between them. Wireless communication between different rooms or floors is generally poor. Wireless communication can be impeded by building materials containing metal or concrete. If the printer cannot communicate with the computer over a wireless LAN due to a wall, place the printer and the computer in the same room.

In addition, if a device like a microwave oven that emits radio waves of the same frequency bandwidth as a wireless router is nearby, it may cause interference. Place the wireless router as far away from interference sources as possible.

Check8 Make sure wireless signal is strong. Monitor signal status and move printer and wireless router as necessary.

To check the radio status,

- For Windows:

■ [Checking Wireless Network Status](#)

- For Mac OS:

■ Monitoring Wireless Network Status

Check9 Make sure the computer is connected to the wireless router.

For more on how to check the computer settings or connection status, see your computer instruction manual or contact its manufacturer.

Check10 Make sure **Enable bidirectional support** is selected in the **Ports** sheet of the properties dialog box of the printer driver. (Windows)

Check11 Make sure security software's firewall is off.

If your security software's firewall is on, a message may appear warning you that Canon software is attempting to access the network. If this warning message appears, set security software to always allow access.

If you are using any programs that switch between network environments, check their settings. Some programs use a firewall by default.

Check12 If printer is connected to an AirPort Base Station via LAN, use alphanumeric characters for network identifier (SSID). (Mac OS)

If the problem is not resolved, redo setup.

- For Windows:

Use the Setup CD-ROM or follow the instructions on the Canon website.

- For Mac OS:

Follow the instructions on the Canon website.



Cannot Find Printer while Using Wired LAN



Check1 Make sure the printer is turned on.

Check2 Is  icon displayed on LCD?

If the icon is not displayed, select **Wired LAN** on **Change LAN** in **LAN settings** under **Device settings**.

Check3 Make sure LAN cable is connected properly.

Make sure the printer is connected to the router with the LAN cable. If the LAN cable is loose, connect the cable properly.

If the LAN cable is connected to the WAN side of the router, connect the cable to the LAN side of the router.

Network Connection Problems

- ▶ **Printer Suddenly Cannot Be Used**
- ▶ **Network Key Unknown**
- ▶ **Administrator Password Set for Printer Unknown**
- ▶ **Printer Cannot Be Used After Replacing Wireless Router or Changing Its Settings**
- ▶ **Printing Is Slow**
- ▶ **Cannot Access to Internet on Wireless LAN from Communication Device**
- ▶ **Ink Level Not Shown on Printer Status Monitor (Windows)**

Printer Suddenly Cannot Be Used

- [Cannot Communicate with Printer Following Network Settings Change](#)
- [Cannot Communicate with Printer via Wireless LAN](#)
- [Cannot Communicate with Printer Using Direct Connection](#)
- [Cannot Communicate with Printer via Wired LAN](#)
- [Cannot Print from Network Computer](#)



Cannot Communicate with Printer Following Network Settings Change



It may take a while for the computer to obtain an IP address, or you may need to restart your computer. Make sure the computer has obtained a valid IP address, and try again to find the printer.



Cannot Communicate with Printer via Wireless LAN



Check1 Make sure the printer is turned on.

Check2 Make sure the printer and wireless router network settings match.

Make sure the network settings of the printer (e.g. wireless router name, SSID, network key, etc.) are identical with those of the wireless router.

To check the settings of the wireless router, refer to the instruction manual provided with it or contact its manufacturer.

To check the current network settings of the printer, print out the network setting information.

- [Printing Network Settings](#)

If the printer network settings do not match with those of the wireless router, change the network settings of the printer to match with those of the wireless router.

- [Network Settings \(IJ Network Device Setup Utility\) \(Windows\)](#)
- Network Communication (Mac OS)

Check3 Make sure the printer is not placed too far away from the wireless router.

Place the wireless router and printer where there are no obstacles between them. Wireless communication between different rooms or floors is generally poor. Wireless communication can be impeded by building materials containing metal or concrete. If the printer cannot communicate with the computer over a wireless LAN due to a wall, place the printer and the computer in the same room.

In addition, if a device like a microwave oven that emits radio waves of the same frequency bandwidth as a wireless router is nearby, it may cause interference. Place the wireless router as far away from interference sources as possible.

Check4 Make sure wireless signal is strong. Monitor signal status and move printer and wireless router as necessary.

- For Windows:
 - [Checking Wireless Network Status](#)
- For Mac OS:
 - [Monitoring Wireless Network Status](#)

Check5 Make sure the computer is connected to the wireless router.

For more on how to check the computer settings or connection status, see your computer instruction manual or contact its manufacturer.

Check6 Make sure you are using a valid channel.

Usable wireless channels may be limited depending on wireless network device used by your computer. See the instruction manual provided with your computer or wireless network device to check usable wireless channels.

Check7 Make sure channel set on wireless router is a usable channel as confirmed in Check 6.

If it is not, change the channel set on the wireless router.

Check8 Make sure security software's firewall is off.

If your security software's firewall is on, a message may appear warning you that Canon software is attempting to access the network. If this warning message appears, set security software to always allow access.

If you are using any programs that switch between network environments, check their settings. Some programs use a firewall by default.

Check9 If printer is connected to an AirPort Base Station via LAN, use alphanumeric characters for network identifier (SSID). (Mac OS)

If the problem is not resolved, redo setup.

- For Windows:
 - Use the Setup CD-ROM or follow the instructions on the Canon website.
- For Mac OS:
 - Follow the instructions on the Canon website.
- **Positioning:**
 - Make sure there are no obstacles between the wireless router and the printer.



Cannot Communicate with Printer Using Direct Connection



Check1 Make sure the printer is turned on.

Check2 Is the  icon displayed on the LCD?

If the icon is not displayed, select **Device settings**, **LAN settings**, **Change LAN** in this order and select **Yes** for **Direct connection** to enable direct connection following the on-screen instructions.

Check3 Make sure printer is selected as connection for device (e.g. smartphone or tablet).

Select the identifier for direct connection (SSID) specified for the printer as the connection destination for devices.

Check4 Have you entered the proper password specified for the direct connection?

If the security setting of the direct connection is enabled, you need to enter the password to connect your device to the printer.

To check the password specified for the printer, print out the network settings information using the operation panel.

■ [Printing Network Settings](#)

Check5 Make sure the printer is not placed too far away from the device.

Place the device and printer where there are no obstacles between them. Wireless communication between different rooms or floors is generally poor. Wireless communication can be impeded by building materials containing metal or concrete. If the printer cannot communicate with the computer over a wireless LAN due to a wall, place the printer and the computer in the same room.

In addition, if a device like a microwave oven that emits radio waves of the same frequency bandwidth as a wireless router is nearby, it may cause interference. Place the wireless router as far away from interference sources as possible.

Place devices a suitable distance from the printer.

Check6 Make sure 5 devices are already connected.

Direct Connection does not allow more than 5 devices to be connected.



Cannot Communicate with Printer via Wired LAN



Check1 Make sure the printer is turned on.

Check2 Make sure the LAN cable is connected properly.

Make sure the printer is connected to the router with the LAN cable. If the LAN cable is loose, connect the cable properly.

If the LAN cable is connected to the WAN side of the router, connect the cable to the LAN side of the router.

If the problem is not resolved, redo setup.

- For Windows:

Use the Setup CD-ROM or follow the instructions on the Canon website to redo setup.

- For Mac OS:

Follow the instructions on the Canon website.

Cannot Print from Network Computer

A

Check1 Make sure the computer is connected to the wireless router.

For more on how to check the computer settings or connection status, see your computer instruction manual or contact its manufacturer.

Check2 If printer driver is not installed, install it.

- For Windows:

Install the printer driver using the Setup CD-ROM or install it from the Canon website.

- For Mac OS:

Install the printer driver from the Canon website.

Check3 When using wireless LAN, make sure wireless router does not restrict which computers can access it.

For more on connecting to and setting up your wireless router, see the wireless router instruction manual or contact its manufacturer.

Note

- To check the MAC address or IP address of your computer, see [Checking Computer IP Address or MAC Address](#).

Network Key Unknown

- [WPA/WPA2 or WEP Key Set for Wireless Router Unknown, Cannot Connect](#)
- [Setting an Encryption Key](#)

WPA/WPA2 or WEP Key Set for Wireless Router Unknown, Cannot Connect

For more on setting up a wireless router, see the instruction manual provided with the wireless router or contact its manufacturer. Make sure your computer can communicate with the wireless router.

Set up the printer to match the wireless router settings using IJ Network Device Setup Utility (for Windows) or IJ Network Tool (for Mac OS).

Setting an Encryption Key

For more on setting up a wireless router, see the instruction manual provided with the wireless router or contact its manufacturer. Make sure your computer can communicate with the wireless router.

Set up the printer to match the wireless router settings using IJ Network Device Setup Utility (for Windows) or IJ Network Tool (for Mac OS).

- **Using WPA/WPA2**

The authentication method, passphrase, and dynamic encryption type must be the same for the wireless router, the printer, and your computer.

Enter the passphrase configured on the wireless router (a sequence of between 8 and 63 alphanumeric characters, or a 64-character hexadecimal number).

Either TKIP (basic encryption) or AES (secure encryption) is selected automatically as the dynamic encryption method.

- For Windows:

For details, see [If WPA/WPA2 Details Screen Appears](#).

- For Mac OS:

For details, see [Changing WPA or WPA2 Detailed Settings](#).

Note

- This printer supports WPA/WPA2-PSK (WPA/WPA2-Personal) and WPA2-PSK (WPA2-Personal).

- **Using WEP**

The key length, key format, key to use (one of 1 to 4), and authentication method must be the same for the wireless router, the printer, and your computer.

To communicate with a wireless router that uses automatically generated WEP keys, you must set the printer to use the key generated by the wireless router, entering it in hexadecimal format.

- For Windows:

When the **WEP Details** screen appears after you click **Search...** on the **Protocol Settings (Wireless LAN)** screen in IJ Network Device Setup Utility, follow the on-screen instructions to set the WEP key length, format, and the number.

For details, see [If WEP Details Screen Appears](#).

- For Mac OS:

Normally, select **Auto** for the authentication method. Otherwise, select **Open System** or **Shared Key** depending on the wireless router's settings.

When the **WEP Details** screen appears after you click **Set** on the **Wireless Routers** screen, follow the on-screen instructions and set the key length, the key format, the key number, and the authentication method to enter a WEP key.

For details, see Changing WEP Detailed Settings.

▶▶ Note

- If the printer is connected to an AirPort Base Station via LAN:

If the printer is connected to an AirPort Base Station via a LAN, check the settings in **Wireless Security of AirPort Utility**.

- Select **64 bit** if **WEP 40 bit** is selected for key length in AirPort Base Station.
- Select **1** for **Key ID**. Otherwise, computer will not be able to communicate with printer via the wireless router.



Administrator Password Set for Printer Unknown



Initialize the printer settings.

Select **All data** to restore administrator password to default.

■ [Reset setting](#)

After initializing the printer settings, redo setup.

- For Windows:
Use the Setup CD-ROM or follow the instructions on the Canon website.
- For Mac OS:
Follow the instructions on the Canon website.



Printer Cannot Be Used After Replacing Wireless Router or Changing Its Settings



When you replace a wireless router, redo the network setup for the printer.

- For Windows:
Use the Setup CD-ROM or follow the instructions on the Canon website.
- For Mac OS:
Follow the instructions on the Canon website.

If this does not solve the problem, see below.

- [Cannot Communicate with Printer After Enabling MAC/IP Address Filtering or Encryption Key on Wireless Router](#)
- [With Encryption On, Cannot Communicate with Printer After Changing Encryption Type at Wireless Router](#)



Cannot Communicate with Printer After Enabling MAC/IP Address Filtering or Encryption Key on Wireless Router



Check1 Check wireless router setting.

To check the wireless router setting, see the instruction manual provided with the wireless router or contact its manufacturer. Make sure the computer and the wireless router can communicate with each other under this setting.

Check2 If filtering MAC addresses or IP addresses at wireless router, check that MAC addresses or IP addresses for computer, network device, and printer are registered.

Check3 If using WPA/WPA2 or WEP key, make sure encryption key for computer, network device, and printer matches key set for wireless router.

Not only the WEP key itself, but also the key length, key format, the key ID to use, and the authentication method must be the same for the printer, the wireless router, and the computer.

For details, see [Setting an Encryption Key](#).

Q With Encryption On, Cannot Communicate with Printer After Changing Encryption Type at Wireless Router

A

If you change the encryption type for the printer and it subsequently cannot communicate with the computer, make sure the encryption type for the computer and the wireless router matches the type set for the printer.

- [Cannot Communicate with Printer After Enabling MAC/IP Address Filtering or Encryption Key on Wireless Router](#)



Printing Is Slow



Check1 Printer may be printing out a large job from another computer.

Check2 When using wireless LAN, make sure the printer is not placed too far away from the wireless router.

Place the wireless router and printer where there are no obstacles between them. Wireless communication between different rooms or floors is generally poor. Wireless communication can be impeded by building materials containing metal or concrete. If the printer cannot communicate with the computer over a wireless LAN due to a wall, place the printer and the computer in the same room.

In addition, if a device like a microwave oven that emits radio waves of the same frequency bandwidth as a wireless router is nearby, it may cause interference. Place the wireless router as far away from interference sources as possible.

Check3 When using wireless LAN, make sure wireless signal is strong. Monitor signal status and move printer and wireless router as necessary.

- For Windows:

- [Checking Wireless Network Status](#)

- For Mac OS:

- [Monitoring Wireless Network Status](#)



Cannot Access to Internet on Wireless LAN from Communication Device



Check1 Is your device connected to printer using direct connection?

If your device is connected to the printer using direct connection, you cannot access to the Internet. Turn off direct connection and connect your device to the wireless router.

For details, see the instruction manual provided with your device and wireless router.

Check2 Is wireless router on?

Check3 Is wireless router configured properly?

For more on checking wireless router settings, see the instruction manual provided with the wireless router or contact its manufacturer.

Check4 Check your device and wireless router location.

Check the distance between your device and wireless router, and check for obstruction or source of radio wave interference nearby.



Ink Level Not Shown on Printer Status Monitor (Windows)



Use the printer driver with bidirectional communication.

Select **Enable bidirectional support** in the **Ports** sheet of the properties dialog box of the printer driver.

- [How to Open the Printer Driver Setup Window](#)

Other Network Problems

- [Message Appears on Computer During Setup](#)
- [Checking Network Information](#)
- [Restoring to Factory Defaults](#)

Message Appears on Computer During Setup

- [Screen to Enter Password Appears During Setup](#)
- [Encryption Settings Screen Appears When Wireless Router Selected](#)
- ["You have connected the printer to the non encrypted wireless network" Appears](#)

Q Screen to Enter Password Appears During Setup

A

The following screen appears if the printer is set up for use with a network and an administrator password has been set.

- For Windows:

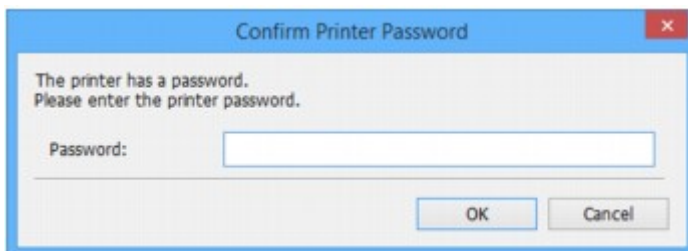

- For Mac OS:



Enter the administrator password set for the printer.

»»» Note

- An administrator password is already set for the printer at the time of purchase.

For details:

- [Administrator Password](#)

For improved security, we recommend that you change the administrator password.

- For Windows:

- [Changing Administrator Password](#)

- For Mac OS:

- [Changing Settings in Admin Password Sheet](#)

Encryption Settings Screen Appears When Wireless Router Selected

A

This screen appears automatically if the selected wireless router is encrypted. Set the same encryption settings as those set for the wireless router.

- For Windows:
For more on encryption settings, see [Performing/Changing Wireless LAN Settings](#).
- For Mac OS:
For more on encryption settings, see Changing Settings in Wireless LAN Sheet.

"You have connected the printer to the non encrypted wireless network" Appears

A

Security is not configured on the wireless router. The printer can still be used, so continue the setup procedure and complete it.

Important

- If you connect to a network that is not protected with security measures, there is a risk of disclosing data such as your personal information to a third party.

Checking Network Information

- [Checking Printer IP Address or MAC Address](#)
- [Checking Computer IP Address or MAC Address](#)
- [Checking Communication Between the Computer, the Printer, and the Wireless Router](#)
- [Checking Network Setting Information](#)

Checking Printer IP Address or MAC Address

To check the printer's IP Address or MAC address, print out the network setting information using the operation panel.

- [Printing Network Settings](#)

You can check the network setting information on the computer screen.

- For Windows:
 - [IJ Network Device Setup Utility Screen](#)
- For Mac OS:
 - Canon IJ Network Tool Menus

Checking Computer IP Address or MAC Address

To check the IP Address or MAC address of your computer, follow the instructions below.

- For Windows:
 1. Select **Command Prompt** as shown below.

In Windows 10, right-click **Start** button and select **Command Prompt**.

In Windows 8.1 or Windows 8, select **Command Prompt** from the **Start** screen. If **Command Prompt** is not displayed on the **Start** screen, select the **Search** charm and search for "**Command Prompt**".

In Windows 7 or Windows Vista, click **Start** > **All Programs** > **Accessories** > **Command Prompt**.
 2. Enter "ipconfig/all" and press **Enter**.

The IP address and MAC address of your computer appear. If your computer is not connected to a network, the IP address does not appear.
- For Mac OS:
 1. Select **System Preferences** from Apple menu, and then click **Network**.
 2. Make sure network interface used by computer is selected, and then click **Advanced**.

When you are using wireless LAN on your computer, make sure **Wi-Fi** is selected as network interface. When you are using wired LAN, make sure **Ethernet** is selected.

3. Check the IP address or MAC address.

Click **TCP/IP** to check the IP address.

Click **Hardware** to check the MAC address.

Checking Communication Between the Computer, the Printer, and the Wireless Router

A

Perform a ping test to check if communication is taking place.

- For Windows:

1. Select **Command Prompt** as shown below.

In Windows 10, right-click **Start** button and select **Command Prompt**.

In Windows 8.1 or Windows 8, select **Command Prompt** from the **Start** screen. If **Command Prompt** is not displayed on the **Start** screen, select the **Search** charm and search for "**Command Prompt**".

In Windows 7 or Windows Vista, click **Start** > **All Programs** > **Accessories** > **Command Prompt**.

2. Type the ping command and press **Enter**.

The ping command is as follows: ping XXX.XXX.XXX.XXX

"XXX.XXX.XXX.XXX" is the IP address of the target device.

If communication is taking place, a message like the one shown below appears.

Reply from XXX.XXX.XXX.XXX: bytes=32 time=10ms TTL=255

If **Request timed out** appears, communication is not taking place.

- For Mac OS:

1. Start **Network Utility** as shown below.

In Mac OS X v10.11, Mac OS X v10.10, or Mac OS X v10.9, select **Computer** from **Go** menu of Finder, double-click **Macintosh HD** > **System** > **Library** > **CoreServices** > **Applications** > **Network Utility**.

In Mac OS X v10.8 or Mac OS X v10.7, open **Utilities** folder in **Applications** folder, then double-click **Network Utility**.

2. Click **Ping**.

3. Make sure **Send only XX pings** (XX are numbers) is selected.

4. Enter IP address of target printer or target wireless router in **Enter the network address to ping**.

5. Click **Ping**.

"XXX.XXX.XXX.XXX" is the IP address of the target device.

A message such as the following appears.

```
64 bytes from XXX.XXX.XXX.XXX: icmp_seq=0 ttl=64 time=3.394 ms
```

```
64 bytes from XXX.XXX.XXX.XXX: icmp_seq=1 ttl=64 time=1.786 ms
```

```
64 bytes from XXX.XXX.XXX.XXX: icmp_seq=2 ttl=64 time=1.739 ms
```

```
--- XXX.XXX.XXX.XXX ping statistics ---
```

```
3 packets transmitted, 3 packets received, 0% packet loss
```

If packet loss is 100%, communication is not taking place. Otherwise, computer is communicating with target device.

Checking Network Setting Information

To check the printer's network settings information, print out the network settings information using the operation panel.

- [Printing Network Settings](#)



Restoring to Factory Defaults



»» Important

- For Windows:

Initialization erases all network settings on the printer, making printing operation from a computer over a network impossible. To use the printer over a network again after restoring it to the factory defaults, use the Setup CD-ROM or follow the instructions on the Canon website to redo setup.

- For Mac OS:

Initialization erases all network settings on the printer, making printing operation from a computer over a network impossible. To use the printer over a network again after restoring it to the factory defaults, follow the instructions on the Canon website to redo setup.

Initialize the network setting using the printer's operation panel.

■ [Reset setting](#)

Problems while Printing from Smartphone/Tablet

- ▶ **Cannot Print from Smartphone/Tablet**

Cannot Print from Smartphone/Tablet

If you cannot print from your smartphone/tablet, it is possible that your smartphone/tablet cannot communicate with the printer.

Check the cause of your problem according to the connection method.

- [Cannot Communicate with Printer over Wireless LAN](#)
- [Cannot Communicate with Printer while It Is in Direct Connection](#)

▶▶▶ Note

- For problems on printing with other connection methods or more on performing settings of each connection method:
 - [Using PIXMA/MAXIFY Cloud Link](#)
 - [Printing with Google Cloud Print](#)
 - [Printing from an AirPrint-enabled Printer with iOS Device](#)



Cannot Communicate with Printer over Wireless LAN



If your smartphone/tablet cannot communicate with the printer, check the following.

Check1 Make sure printer is turned on.

Check2 Set **Change LAN** in **LAN settings** under **Device settings** to **Wireless LAN**.

Check3 Are network settings of printer identical with those of wireless router?

Make sure the network settings of the printer (e.g. wireless router name, SSID, network key, etc.) are identical with those of the wireless router.

To check the settings of the wireless router, refer to the instruction manual provided with it or contact its manufacturer.

To check the current network settings of the printer, print out the network setting information.

- [Printing Network Settings](#)

If the network settings of the printer are not identical with those of the wireless router, match the network settings of the printer to those of the wireless router.

Check4 Are network settings of your smartphone/tablet identical with those of wireless router?

Make sure the network settings of your smartphone/tablet (e.g. wireless router name, SSID, network key, etc.) are identical with those of the wireless router.

To check the settings of your smartphone/tablet, refer to the instruction manual provided with it.

If the network settings of your smartphone/tablet are not identical with those of the wireless router, change the network settings of it to match with those of the wireless router.

Check5 Make sure printer is not too far away from wireless router.

Locate the printer close enough to communicate with the wireless router.

Check6 Check for obstructions.

Wireless communication between different rooms or floors is generally poor. Move the printer and wireless router as necessary.

Check7 Make sure there is no source of radio wave interference nearby.

If a device like a microwave oven that emits radio waves of the same frequency bandwidth as a wireless router is nearby, it may cause interference. Place the wireless router as far away from the interference source as possible.

Cannot Communicate with Printer while It Is in Direct Connection

A

If your smartphone/tablet cannot communicate with the printer in the direct connection, check the following.

Check1 Make sure printer is turned on.

Check2 Set **Change LAN** in **LAN settings** under **Device settings** to **Direct connection**.

Check3 Check settings of your smartphone/tablet.

Make sure your smartphone/tablet can use the wireless LAN.

For more on performing setting of the wireless LAN, refer to the instruction manual provided with your smartphone/tablet.

Check4 Have you selected printer as destination of your smartphone/tablet?

Select the access point name (SSID) of the printer with your smartphone/tablet.

Check5 Have you entered proper password specified for direct connection?

If the security setting of the direct connection is enabled, you need to enter the password to connect your smartphone/tablet to the printer.

Check6 Make sure printer is not too far away.

Locate your smartphone/tablet close enough to communicate with the printer.

Check7 Check for obstructions.

Wireless communication between different rooms or floors is generally poor. Move the printer as necessary.

Check8 Make sure there is no source of radio wave interference nearby.

If a device like a microwave oven that emits radio waves of the same frequency bandwidth as a wireless router is nearby, it may cause interference. Place the printer as far away from the interference source as possible.

Check9 Make sure 5 devices are already connected.

Direct connection does not allow more than 5 devices to be connected.

Printing Problems

- ▶ **Printing Does Not Start**
- ▶ **Paper Jams**
- ▶ **Print Results Are Unsatisfactory**
- ▶ **No Ink Comes Out**
- ▶ **Paper Does Not Feed Properly/"No Paper" Error**
- ▶ **Automatic Duplex Printing Problems**
- ▶ **Printing Stops**
- ▶ **Cannot Print Using AirPrint**



Printing Does Not Start



Check1 Make sure printer is securely plugged in and press **ON** button to turn it on.

The **POWER** lamp flashes while the printer is initializing. Wait until the **POWER** lamp stops flashing and remains lit.

▶▶▶ Note

- If you are printing large data such as photos or other graphics, printing may take longer to start. The **POWER** lamp flashes while the computer is processing data and sending it to the printer. Wait until printing starts.

Check2 Make sure printer is properly connected to computer.

If you are using a USB cable, make sure it is securely connected to both the printer and the computer. When the USB cable is securely plugged in, check the following:

- If you are using a relay device such as a USB hub, disconnect it, connect the printer directly to the computer, and retry the printing. If printing starts normally, there is a problem with the relay device. Contact the vendor of the relay device.
- There could also be a problem with the USB cable. Replace the USB cable and retry the printing.

If you use the printer over a LAN, make sure the printer is connected to the network with a LAN cable or is correctly set up for network use.

Check3 Is direct connection enabled?

To print using a mode other than the direct connection, disable the direct connection first.

■ [Using Printer with Direct Connection](#)

Check4 Make sure paper settings match information set for cassette.

If the paper settings do not match the information set for the cassette, an error message appears on the LCD. Follow the instructions on the LCD to solve the problem.

■ [Paper Settings](#)

▶▶▶ Note

- You can select whether the message which prevents misprinting is displayed.
 - To change the message view setting when printing using the printer's operation panel:
 - [Cassette settings](#)
 - To change the message view setting when printing using the printer driver:
 - [Changing the Printer Operation Mode](#) (Windows)

Check5 Delete unnecessary print jobs.

- For Windows:

■ [Deleting the Undesired Print Job](#)

- For Mac OS:

■ [Deleting the Undesired Print Job](#)

Check6 Is your printer's printer driver is selected when printing?

The printer will not print properly if you are using a printer driver for a different printer.

- For Windows:

Make sure "Canon XXX series" (where "XXX" is your printer's name) is selected in the Print dialog box.

▶▶▶ **Note**

- To make the printer the one selected by default, select **Set as Default Printer**.

- For Mac OS:

Make sure your printer's name is selected in **Printer** in the Print dialog.

▶▶▶ **Note**

- To make the printer the one selected by default, select the printer for **Default printer**.

Check7 Set correct printer port. (Windows)

Make sure the correct printer port is set.

1. Log in using an account with administrator privileges.
2. Make the following settings.

- In Windows 10, right-click **Start** button and select **Control Panel > View devices and printers**.
- In Windows 8.1 or Windows 8, select **Control Panel** from **Settings** charm on **Desktop > Hardware and Sound > Devices and Printers**.
- In Windows 7, select **Devices and Printers** from **Start** menu.
- In Windows Vista, select **Start** menu > **Control Panel > Hardware and Sound > Printers**.

3. Open printer driver properties.

- In Windows 10, Windows 8.1, Windows 8, or Windows 7, right-click "Canon XXX series" icon (where "XXX" is your printer's name), and then select **Printer properties**.
- In Windows Vista, right-click "Canon XXX series" icon (where "XXX" is your printer's name), and then select **Properties**.

4. Click **Ports** tab to check port settings.

Make sure a port named "USBnnn" (where "n" is a number) with "Canon XXX series" appearing in **Printer** column is selected for **Print to the following port(s)**.

- If setting is incorrect:

Reinstall the printer driver from the Setup CD-ROM or the Canon website.

- If printing does not start even though the printer is connected to the computer using a USB cable and the port named "USBnnn" is selected:

In Windows 8.1 or Windows 8, select **My Printer** on **Start** screen to start **My Printer**. If **My Printer** is not displayed on **Start** screen, select **Search** charm, and then search for "**My Printer**".

Set the correct printer port on **Diagnose and Repair Printer**. Follow the on-screen instructions to set the correct printer port, and then select your printer's name.

In Windows 7 or Windows Vista, click **Start** and select **All programs, Canon Utilities, Canon My Printer, Canon My Printer**, and then select **Diagnose and Repair Printer**. Follow the on-screen instructions to set the correct printer port, and then select your printer's name.

If the problem is not resolved, reinstall the printer driver from the Setup CD-ROM or the Canon website.

Check8 Is print data extremely large? (Windows)

Click **Print Options** on **Page Setup** sheet of the printer driver. Then set **Prevention of Print Data Loss** to **On** in the dialog that appears.

* This may reduce print quality.

Check9 Restart your computer.



Paper Jams



When paper jams, a troubleshooting message appears automatically. Take the appropriate action described in the message.

- **When a Support Code and a Message Are Displayed on Computer Screen:**

- For Windows:

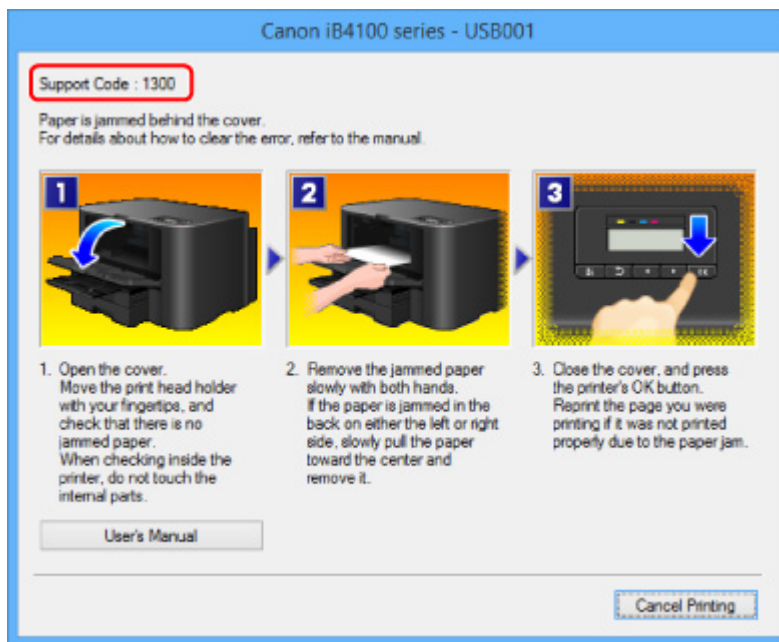

- For Mac OS:

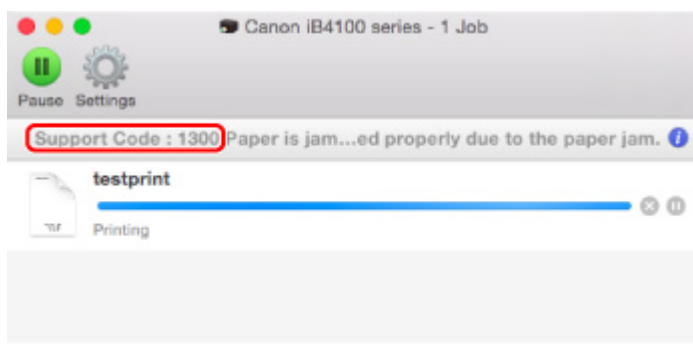

* The screen differs depending on the OS you are using.

- **When a Support Code and a Message Are Displayed on LCD:**

Paper jammed
Remove the paper f 1300

To remove the jammed paper, see [List of Support Code for Error \(Paper Jams\)](#).

»» Note

- You can also search for details on resolving the errors indicated by the support code shown.

■ [Search](#)



Print Results Are Unsatisfactory



If the print results are unsatisfactory due to white streaks, misaligned lines, or uneven colors, check the paper and print quality settings first.

Check1 Do page size and media type settings match size and type of loaded paper?

If these settings do not match, it is not possible to obtain the proper result.

If you are printing a photograph or an illustration, an incorrect paper type setting may reduce the quality of the printout color.

Also, if you print with an incorrect paper type setting, the printed surface may be scratched.

Check the page size and media type settings using the printer driver.

- For Windows:

■ [Printing with Easy Setup](#)

- For Mac OS:

■ [Printing with Easy Setup](#)

Check2 Make sure appropriate print quality is selected using printer driver.

Select a print quality suited to the paper and to what you are printing. If you notice blurs or uneven colors, increase the print quality setting and retry the printing.

You can check the print quality setting using the printer driver.

- For Windows:

■ [Changing the Print Quality and Correcting Image Data](#)

- For Mac OS:

■ [Changing the Print Quality and Correcting Image Data](#)

Check3 If problem is not resolved, check other causes.

See also the sections below:

- [Cannot Complete Printing](#)
- [Part of Page Is Not Printed \(Windows\)](#)
- [Paper Is Blank/Printing Is Blurry/Colors Are Wrong/White Streaks Appear](#)
- [Lines Are Misaligned](#)
- [Lines Incomplete or Missing \(Windows\)](#)
- [Images Incomplete or Missing \(Windows\)](#)
- [Ink Blots / Paper Curl](#)
- [Paper Is Smudged / Printed Surface Is Scratched](#)
- [Back of Paper Is Smudged](#)
- [Uneven or Streaked Colors](#)



Cannot Complete Printing



Check1 Select setting not to compress printing data. (Windows)

If you select the setting not to compress the printing data with an application software you are using, the printing result may be improved.

Click **Print Options** on **Page Setup** sheet of the printer driver. Select **Do not allow application software to compress print data** check box and click **OK**.

* Clear the check box once printing is complete.

Check2 Is print data extremely large? (Windows)

Click **Print Options** on **Page Setup** sheet of the printer driver. Then set **Prevention of Print Data Loss** to **On** in the dialog that appears.

* This may reduce print quality.

Check3 Your hard disk may not have sufficient free space to store job.

Delete unnecessary files to free up disk space.



Part of Page Is Not Printed (Windows)



Check Are you using automatic duplex printing?

If you are using automatic duplex printing, the printable area at the top of the page will be 0.08 inches / 2 mm shorter than usual.

Therefore, the bottom of the page may not be printed. To prevent this, set reduced printing on the printer driver.

»» Important

- Reducing the printing size may affect the layout of your document.

If the application you used to create your document has a zoom function, set the reduced size in the application.

1. Open printer driver setup window.
 - [How to Open the Printer Driver Setup Window](#)
2. Check **Duplex Printing** check box in **Page Setup** sheet.
3. Click **Print Area Setup** and select **Use reduced printing**.



Paper Is Blank/Printing Is Blurry/Colors Are Wrong/White Streaks Appear

❖ Paper Is Blank



❖ Printing Is Blurry



❖ Colors Are Wrong

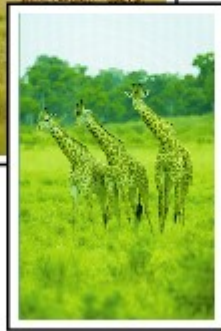
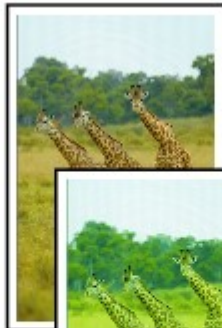

White Streaks Appear



A

Check1 Check paper and print quality settings.

■ [Print Results Are Unsatisfactory](#)

Check2 Check status of ink tanks. Replace ink tank if ink has run out.

■ [Replacing Ink Tanks](#)

Check3 Print nozzle check pattern and perform any necessary maintenance operations such as print head cleaning.

Print the nozzle check pattern to determine whether the ink ejects properly from the print head nozzles.

For details on printing the nozzle check pattern, print head cleaning, and print head deep cleaning, see [If Printing Is Faint or Uneven](#).

- If nozzle check pattern is not printed correctly:

Check if the ink tank for the problem color is empty.

If the ink tank is not empty, perform print head cleaning and try printing the nozzle check pattern again.

- If problem is not resolved after performing print head cleaning twice:

Perform print head deep cleaning.

If the problem is not resolved after performing print head deep cleaning, turn off the printer and perform print head deep cleaning again 24 hours later.

- If problem is not resolved after performing print head deep cleaning twice:

If print head deep cleaning does not resolve the problem, the print head may be damaged. Contact your nearest Canon service center to request a repair.

Check4 When using paper with one printable surface, make sure paper is loaded with printable side facing down.

Printing on the wrong side of such paper may cause unclear prints or prints with reduced quality.

Load paper with the printable side facing down.

Refer to the instruction manual supplied with the paper for detailed information on the printable side.



Lines Are Misaligned



Check1 Check paper and print quality settings.

■ [Print Results Are Unsatisfactory](#)

Check2 Perform print head alignment.

If printed lines are misaligned or print results are otherwise unsatisfactory, adjust the print head position.

■ [Aligning the Print Head](#)

▶▶▶ Note

- If the problem is not resolved after performing the print head alignment, perform print head alignment manually from your computer.
 - For Windows:
 - [Aligning the Print Head Position Manually](#)
 - For Mac OS:
 - [Aligning the Print Head Position Manually](#)

Check3 Increase print quality and try printing again.

Increasing the print quality using the operation panel may improve the print result.

Check4 If lines are misaligned with manual duplex printing, perform automatic duplex printing. (Windows)



Lines Incomplete or Missing (Windows)



Check1 Are you using Page Layout Printing or Binding Margin function?

When the Page Layout Printing or Binding margin function is in use, thin lines may not be printed. Try thickening the lines in the document.

Check2 Is print data extremely large?

Click **Print Options** on **Page Setup** sheet of the printer driver. Then set **Prevention of Print Data Loss** to **On** in the dialog that appears.

* This may reduce print quality.



Images Incomplete or Missing (Windows)



Check1 Select setting not to compress printing data.

If you select the setting not to compress the printing data with an application software you are using, the printing result may be improved.

Click **Print Options** on **Page Setup** sheet of the printer driver. Select **Do not allow application software to compress print data** check box and click **OK**.

* Clear the check box once printing is complete.

Check2 Is print data extremely large?

Click **Print Options** on **Page Setup** sheet of the printer driver. Then set **Prevention of Print Data Loss** to **On** in the dialog that appears.

* This may reduce print quality.



Ink Blots / Paper Curl

Ink Blots



Paper Curl



Check1 Check paper and print quality settings.

 [Print Results Are Unsatisfactory](#)

Check2 If intensity is set high, reduce intensity setting and try printing again.

If you are printing with a high intensity setting on plain paper, the paper may absorb too much ink and become wavy, causing paper abrasion.

Check the intensity setting in the printer driver.

- For Windows:

 [Adjusting Intensity](#)

- For Mac OS:

 [Adjusting Intensity](#)

Check3 Use Photo Paper to print photos.

To print data with high color saturation such as photographs or images with dark colors, we recommend that you use Photo Paper Plus Glossy II or other Canon specialty paper.

 [Supported Media Types](#)



Paper Is Smudged / Printed Surface Is Scratched

Paper Is Smudged

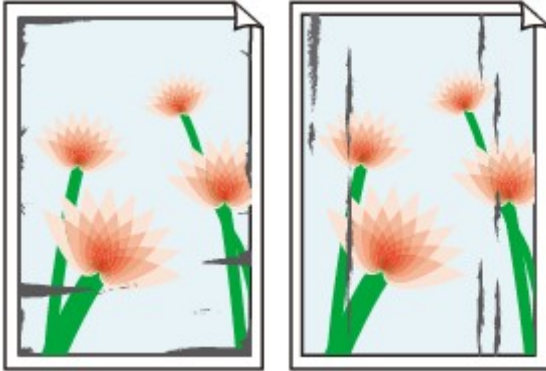

Smudged Edges

Smudged Surface



Printed Surface Is Scratched



Check1 Check paper and print quality settings.

 [Print Results Are Unsatisfactory](#)

Check2 Check paper type.

Make sure you are using the right paper for what you are printing.

 [Supported Media Types](#)

Check3 Correct curl before loading paper.

When using Photo Paper Plus Semi-gloss, even if the sheet is curled, load one sheet at a time as it is. Rolling this paper in the opposite direction to flatten it may crack the paper surface and reduce the print quality.

We recommend putting unused paper back into the package and storing it flat.

- Plain Paper

Turn the paper over and reload it to print on the other side.

- Other Paper

If the paper corners curl more than 0.1 inch / 3 mm (A) in height, the paper may smudge or may not feed properly. Follow the instructions below to correct the paper curl.



1. Roll up paper in opposite direction to paper curl as shown below.

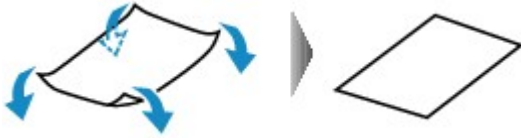

2. Check that paper is now flat.

We recommend printing curl-corrected paper one sheet at a time.

►► Note

- Depending on paper type, the paper may smudge or may not feed properly even if it is not curled inward. Follow the instructions below to curl the paper outward up to 0.1 inch / 3 mm (B) in height before printing. This may improve the print result.

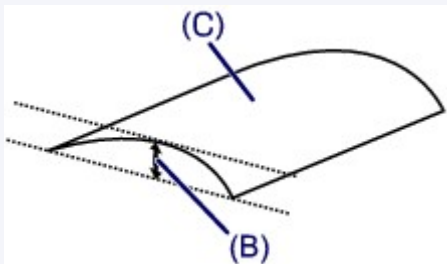

(C) Print side

We recommend feeding paper that has been curled outward one sheet at a time.

Check4 Set printer to prevent paper abrasion.

Adjusting the setting to prevent paper abrasion will widen the clearance between the print head and the paper. If you notice abrasion even with the media type set correctly to match the paper, set the printer to prevent paper abrasion using the operation panel or the computer.

This may reduce the print speed.

* Once you have finished printing, undo this setting. Otherwise, it will apply to subsequent print jobs.

- From operation panel

Press the **Setup** button, and then select **Device settings** and **Output settings** in this order and set **Prevent abrasion** to **ON**.

■ [Changing Settings from Operation Panel](#)

- From computer

- For Windows:

Open the printer driver setup window, select **Custom Settings** in **Maintenance** sheet, select **Prevent paper abrasion** check box, and then click **OK**.

To open the printer driver setup window, see [How to Open the Printer Driver Setup Window](#).

- For Mac OS:

In the Canon IJ Printer Utility, select **Custom Settings** in the pop-up menu, select **Prevent paper abrasion** check box, and then click **Apply**.

To open the Canon IJ Printer Utility, see [Opening the Canon IJ Printer Utility](#).

Check5 If intensity is set high, reduce intensity setting and try printing again.

If you are printing with a high intensity setting on plain paper, the paper may absorb too much ink and become wavy, causing paper abrasion.

Check the intensity setting in the printer driver.

- For Windows:

■ [Adjusting Intensity](#)

- For Mac OS:

■ [Adjusting Intensity](#)

Check6 Do not print outside recommended printing area.

If you print outside the recommended printing area of your paper, ink may stain the lower edge of the paper.

Resize the document using application software.

■ [Print Area](#)

Check7 Is paper feed roller dirty?

Clean the paper feed roller.

■ [Cleaning Paper Feed Rollers](#)

▶▶▶ Note

- Cleaning the paper feed roller abrades it, so do this only when necessary.

Check8 Is inside of printer dirty?

During duplex printing, ink may stain the inside of the printer, smudging the printout.

Perform the bottom plate cleaning to clean the inside of the printer.

■ [Cleaning Inside the Printer \(Bottom Plate Cleaning\)](#)

▶▶▶ Note

- To prevent staining inside the printer, be sure to set the correct paper size.

Check9 Set longer ink drying time.

This allows the printed surface to dry, preventing smudges and scratches.

- For Windows:

1. Make sure printer is turned on.
2. Open printer driver setup window.

■ [How to Open the Printer Driver Setup Window](#)

3. Click **Maintenance** tab and **Custom Settings**.

4. Drag **Ink Drying Wait Time** slide bar to set wait time and click **OK**.
 5. Check message and click **OK**.
- For Mac OS:
 1. Make sure printer is turned on.
 2. Open Canon IJ Printer Utility.
 - Opening the Canon IJ Printer Utility
 3. Select **Custom Settings** in pop-up menu.
 4. Drag **Ink Drying Wait Time**: slide bar to set wait time and click **Apply**.
 5. Check message and click **OK**.



Back of Paper Is Smudged

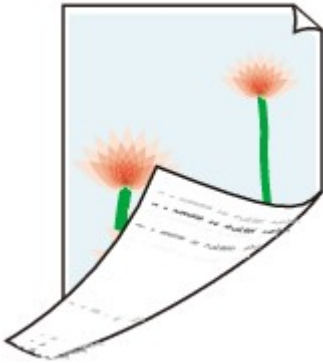

Check1 Check paper and print quality settings.

■ [Print Results Are Unsatisfactory](#)

Check2 Perform bottom plate cleaning to clean inside of printer.

■ [Cleaning Inside the Printer \(Bottom Plate Cleaning\)](#)

▶▶ Note

- During duplex printing or too much printing, ink may stain the inside of the printer.

Q

Uneven or Streaked Colors

▣ Uneven Colors



▣ Streaked Colors



A

Check1 Check paper and print quality settings.

■ [Print Results Are Unsatisfactory](#)

Check2 Print nozzle check pattern and perform any necessary maintenance operations such as print head cleaning.

Print the nozzle check pattern to determine whether the ink ejects properly from the print head nozzles.

For details on printing the nozzle check pattern, print head cleaning, and print head deep cleaning, see [If Printing Is Faint or Uneven](#).

- If nozzle check pattern is not printed correctly:
 - Check if the ink tank for the problem color is empty.

If the ink tank is not empty, perform print head cleaning and try printing the nozzle check pattern again.

- If problem is not resolved after performing print head cleaning twice:

Perform print head deep cleaning.

If the problem is not resolved after performing print head deep cleaning, turn off the printer and perform print head deep cleaning again 24 hours later.

- If problem is not resolved after performing print head deep cleaning twice:

If print head deep cleaning does not resolve the problem, the print head may be damaged. Contact your nearest Canon service center to request a repair.

Check3 Perform print head alignment.

■ [Aligning the Print Head](#)

▶▶▶ Note

- If the problem is not resolved after performing the print head alignment, perform print head alignment manually from your computer.
 - For Windows:
 - [Aligning the Print Head Position Manually](#)
 - For Mac OS:
 - [Aligning the Print Head Position Manually](#)



No Ink Comes Out



Check1 Has ink run out?

Check the support code on the LCD and take the appropriate action to resolve the error.

■ [List of Support Code for Error](#)

Check2 Are print head nozzles clogged?

Print the nozzle check pattern to determine whether the ink ejects properly from the print head nozzles.

For details on printing the nozzle check pattern, print head cleaning, and print head deep cleaning, see [If Printing Is Faint or Uneven](#).

- If nozzle check pattern is not printed correctly:
Check if the ink tank for the problem color is empty.
If the ink tank is not empty, perform print head cleaning and try printing the nozzle check pattern again.
- If problem is not resolved after performing print head cleaning twice:
Perform print head deep cleaning.
If the problem is not resolved after performing print head deep cleaning, turn off the printer and perform print head deep cleaning again 24 hours later.
- If problem is not resolved after performing print head deep cleaning twice:
If print head deep cleaning does not resolve the problem, the print head may be damaged. Contact your nearest Canon service center to request a repair.



Paper Does Not Feed Properly/"No Paper" Error



Check1 Make sure paper is loaded.

■ [Loading Paper](#)

Check2 When loading paper, consider the following.

- When loading two or more sheets of paper, flip through the paper before loading it. In addition, when you load paper with some paper remaining in the cassette, flip through the remaining paper and the newly loaded paper before loading.



- When loading two or more sheets of paper, align the edges of the sheets before loading the paper.
- When loading two or more sheets of paper, make sure the paper stack does not exceed the paper load limit.

However, paper may not feed correctly at the maximum capacity, depending on the type of paper or environmental conditions (very high or low temperature and humidity). In such cases, reduce the amount of paper you load at a time to less than half of the paper load limit.

- Always load the paper in portrait orientation, regardless of the printing orientation.

■ [Loading Paper](#)

»»» Important

- When loading paper in the cassette, slide the paper guide on the front side to align with the corresponding mark of page size. Load the paper with the print side facing DOWN, load the paper stack in the center of the cassette and slide the paper guides to align with the both edges of the paper stack.

■ [Loading Paper](#)

Check3 Is paper too thick or curled?

■ [Unsupported Media Types](#)

Check4 When loading postcards or envelopes, consider the following:

- If a postcard is curled, it may not feed properly even though the paper stack does not exceed the paper load limit.

Load Japanese postcards with their postcode column toward the far end of the cassette 1.

- When printing on envelopes, see [Loading Paper](#), and prepare the envelopes before printing.

Once you have prepared the envelopes, load them in portrait orientation. If the envelopes are placed in landscape orientation, they will not feed properly.

Check5 Make sure media type and paper size settings match with loaded paper.

Check6 Clean paper feed roller.

■ [Cleaning Paper Feed Rollers](#)

▶▶▶ Note

- Cleaning the paper feed roller abrades it, so do this only when necessary.

Check7 If two or more sheets of paper feed from cassette at once, clean inside of cassette.

For information on cleaning the inside of the cassette, see [Cleaning Cassette Pads](#).

If the measures above do not solve the problem, contact your nearest Canon service center to request a repair.



Automatic Duplex Printing Problems



Check1 Is automatic duplex printing selected?

- For Windows:

Make sure **Duplex Printing** and **Automatic** check boxes are selected on **Page Setup** sheet in the printer driver setup window.

 [Duplex Printing](#)

- For Mac OS:

Make sure **Two-Sided** check box is selected on the Print dialog.

 Duplex Printing

Check2 Make sure loaded paper size is suitable for automatic duplex printing.

The paper sizes suitable for automatic two-sided printing are A4 and Letter.

Load paper of suitable size and press the **OK** button.

Check3 Make sure paper size setting is correct.

Make sure the paper size setting is appropriate for automatic duplex printing.

Check the paper size setting in the application software.

Then, check the paper size setting in the printer driver.

- For Windows:

Check **Page Size** setting in **Page Setup** sheet in the printer driver setup window.

- For Mac OS:

Check **Paper Size** in the Page Setup dialog.

Note

- Duplex printing may not be available depending on the version of the application software.

Check4 Make sure media type setting is correct.

Make sure the media type setting is appropriate for automatic duplex printing.

- For Windows:

Make sure the loaded paper is suited to automatic duplex printing in **Main** sheet in the printer driver setup window.

- For Mac OS:

Make sure the loaded paper is suited to automatic duplex printing in **Quality & Media** sheet in the Print dialog.

▶▶▶ Note

- For Windows:

To switch to manual duplex printing, follow the procedure below.

Open the printer driver setup window, clear **Automatic** check box on **Page Setup** sheet, and reprint.

When performing manual duplex printing, note the following.

- If you are printing three or more pages of a document with manual duplex printing, one side of each sheet is printed first. Turn over and reload the paper to print the reverse sides. Do not change the order of the sheets.
 - The procedure for turning the paper over varies depending on the staple side and printing orientation. Follow the on-screen instructions.
- For Mac OS:
Manual duplex printing is not available.



Printing Stops



Check1 Is paper loaded?

Make sure paper is loaded.

If necessary, load paper.

Check2 Do documents to be printed have many photographs or illustrations?

It takes time for the printer and the computer to process large data such as photos or other graphics, so it may seem that the printer is not working.

Also, if you are printing data that requires a lot of ink on successive sheets of plain paper, the printer may pause temporarily. In either case, wait until the process is complete.

▶▶▶ Note

- If you are printing a document with a large printing area or printing several copies, printing may pause to allow the ink to dry.

Check3 Has printer been printing continuously for a long period?

If the printer has been printing continuously for a long time, the print head or other parts around it may overheat. The printer may stop printing at a line break for a period of time and then resume printing.

In this case, wait a while without doing anything. If the printing does not resume, interrupt your print session and turn the printer off for at least 15 minutes.

⚠ Caution

- Print head and surrounding area can become extremely hot. Never touch print head or nearby components.



Cannot Print Using AirPrint



Check1 Make sure printer is turned on.

If the printer is turned on, turn it off and back on, and then check whether the issue is resolved.

Check2 Make sure printer is connected by LAN to same network subnet as AirPrint compliant device when printing over LAN.

Check3 Make sure printer has enough paper and ink.

Check4 Make sure no error message is displayed on printer's LCD.

If the problem is not resolved, use the printer driver on your computer to execute printing and check whether the document can be printed normally on the printer.

Mechanical Problems

- ▶ **Power Does Not Come On**
- ▶ **Power Shuts Off By Itself**
- ▶ **USB Connection Problems**
- ▶ **Cannot Communicate with Printer via USB**
- ▶ **LCD Is Off**
- ▶ **LCD Shows Wrong Language**
- ▶ **Print Head Holder Does Not Move to Replacement Position**
- ▶ **Printer Status Monitor Not Displayed (Windows)**



Power Does Not Come On



Check1 Press **ON** button.

Check2 Make sure power plug is securely connected to printer, and then turn it back on.

Check3 Unplug printer, leave it for at least 2 minutes, and then plug it back in and turn it on again.

If this does not solve the problem, contact your nearest Canon service center to request a repair.



Power Shuts Off By Itself



Check If printer is set to turn off automatically after a certain time, disable this setting.

If you have set the printer to turn off automatically after a specified time, the power will shut off by itself once that time has elapsed.

- If you are using a Windows and if you do not want the printer to turn off automatically:

Open the printer driver setup window and in **Auto Power** in **Maintenance** sheet, select **Disable** for **Auto Power Off**.

- If you are using a Mac OS and if you do not want the printer to turn off automatically:

Open Canon IJ Printer Utility, select **Power Settings** in the pop-up menu, and then select **Disable** for **Auto Power Off** on **Auto Power**.

USB Connection Problems

Q Printing Is Slow/Hi-Speed USB Connection Does Not Work/"This device can perform faster" Message Appears (Windows)

A

If your system environment does not support Hi-Speed USB, the printer operates at the slower speed of USB 1.1. In this case, the printer works properly but printing speed may slow down due to the communication speed.

Check

Check following to make sure your system environment supports Hi-Speed USB connection.

- Does the USB port on your computer support Hi-Speed USB connection?
- Does the USB cable or the USB hub support Hi-Speed USB connection?

Be sure to use a certified Hi-Speed USB cable. We recommend that the USB cable be no longer than 10 feet / 3 meters or so.

- Does the operating system of your computer support Hi-Speed USB connection?

Install the latest update for your computer.

- Is the Hi-Speed USB driver working properly?

If necessary, obtain and install the latest version of the Hi-Speed USB driver for your computer.

»» Important

- For more information, contact the manufacturer of your computer, USB cable, or USB hub.



Cannot Communicate with Printer via USB



Check1 Make sure printer is turned on.

Check2 Connect USB cable properly.

As the illustration below, the USB port is at the back of the printer.

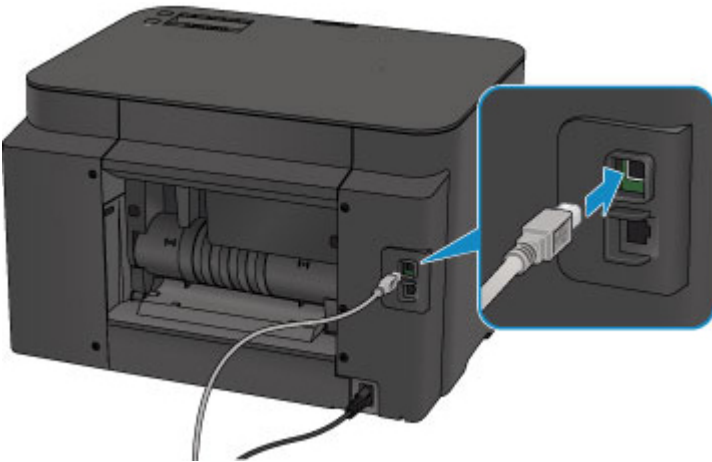

Check3 Do not start IJ Network Tool while printing. (Mac OS)

Check4 Do not print while IJ Network Tool is running. (Mac OS)

Check5 Make sure **Enable bidirectional support** is selected in **Ports** sheet of properties dialog box of printer driver. (Windows)

■ [How to Open the Printer Driver Setup Window](#)



LCD Is Off



- If **POWER** lamp is off:
The printer is not on. Check that the power cord is connected and press the **ON** button.
- If **POWER** lamp is lit:
The LCD may be in screen-saver mode. Press any button on the operation panel.



LCD Shows Wrong Language



Follow the instructions below to select your language.

1. Press **Setup** button and wait for about 5 seconds.
2. Press ► button once and press **OK** button.
3. Press ► button twice and press **OK** button.
4. Press **OK** button again.
5. Use ◀▶ button to select language for LCD and press **OK** button.

The desired language is displayed on the LCD.



Print Head Holder Does Not Move to Replacement Position



»» Important

- The print head holder moves to the position for replacing only when an ink tank runs out of ink. If no ink tanks run out of ink, the print head holder does not move even though you open the front cover.

Check1 Is **POWER** lamp off?

Check if the **POWER** lamp is lit.

The **POWER** lamp flashes while the printer is initializing. Wait until the **POWER** lamp stops flashing and remains lit, and then open the front cover again.

Check2 Is an error message displayed on LCD?

Close the front cover, follow the support code (error number) displayed in the error message to resolve the error, and then reopen it. For details on resolving the error, see [List of Support Code for Error](#).

Check3 Has front cover been left open for 60 minutes or longer?

If the front cover is left open for more than 60 minutes, the print head holder moves to the position to protect it to prevent the print head from drying out. Close and reopen the front cover to return the print head holder to the position for replacing.

The print head holder will not move unless the power is on. If the **POWER** lamp is off, close the front cover and turn the printer on.



Printer Status Monitor Not Displayed (Windows)



Check1 Is printer status monitor enabled?

Make sure **Enable Status Monitor** is selected on the **Option** menu of the printer status monitor.

1. Open printer driver setup window.
 - [How to Open the Printer Driver Setup Window](#)
2. On **Maintenance** sheet, click **View Printer Status**.
3. Select **Enable Status Monitor** on **Option** menu if it is not selected.

Installation and Download Problems

- ▶ **Cannot Install Printer Driver**
- ▶ **Easy-WebPrint EX Does Not Start or Easy-WebPrint EX Menu Does Not Appear (Windows)**
- ▶ **Updating Printer Driver in Network Environment (Windows)**



Cannot Install Printer Driver



■ [For Windows:](#)

■ [For Mac OS:](#)

For Windows:

- **If installation does not start when you insert Setup CD-ROM:**

Follow the instructions below to start the installation.

1. Make the following settings.

- In Windows 10, click **Start** button > **File Explorer**, and then click **This PC** from list on left.
- In Windows 8.1 or Windows 8, select **Explorer** icon in **Taskbar** on **Desktop**, and then select **This PC (Computer for Windows 8)** from list on left.
- In Windows 7 or Windows Vista, click **Start**, and then click **Computer**.

2. Double-click  **CD-ROM** icon in the window that appears.

If the contents of the CD-ROM appear, double-click **MSETUP4.EXE**.

If you cannot install the printer driver with the Setup CD-ROM, install them from the Canon website.

▶▶▶ Note

- If the CD-ROM icon does not appear, try the following:
 - Remove the CD-ROM from your computer and reinsert it.
 - Restart your computer.

If the icon still does not appear, try a different disc and see if it appears. If it does, there is a problem with the Setup CD-ROM. Contact your nearest Canon service center to request a repair.

- If you cannot get past the Printer Connection screen:



■ [Cannot Proceed beyond Printer Connection Screen/Connect Cable Screen](#)

- Other cases:

Reinstall the printer driver.

If the printer driver were not installed correctly, uninstall the printer driver, restart your computer, and then reinstall the printer driver.

■ [Deleting the Unnecessary Printer Driver](#)

Reinstall the printer driver with the Setup CD-ROM or install them from the Canon website.

▶▶▶ **Note**

- If the installer was stopped due to a Windows error, Windows operation may be unstable, and you may not be able to install the drivers. Restart your computer and then reinstall the driver.

For Mac OS:

Download the driver from the support page of Canon website and reinstall it.



Easy-WebPrint EX Does Not Start or Easy-WebPrint EX Menu Does Not Appear (Windows)



If Easy-WebPrint EX does not start or its menu does not appear on Internet Explorer, check the following.

Check1 Is **Canon Easy-WebPrint EX** displayed on **Toolbars** menu in Internet Explorer's **View** menu?

If **Canon Easy-WebPrint EX** is not displayed, Easy-WebPrint EX is not installed on your computer. Install the latest version of Easy-WebPrint EX from the Canon website.

▶▶▶ Note

- If Easy-WebPrint EX is not installed, a message asking you to install it may appear in the notification area on the desktop. Click the message and follow the instructions to install Easy-WebPrint EX.
- Internet access is required to install or download Easy-WebPrint EX.

Check2 Is **Canon Easy-WebPrint EX** selected on **Toolbars** menu in Internet Explorer's **View** menu?

If **Canon Easy-WebPrint EX** is not selected, Easy-WebPrint EX is disabled. Select **Canon Easy-WebPrint EX** to enable it.



Updating Printer Driver in Network Environment (Windows)



Download the latest printer driver.

The latest printer driver for your model are available for download on the Canon website.

Uninstall the existing printer driver and follow the installation instructions to install the latest printer driver that you downloaded. In the connection method selection screen, select **Use the printer with wireless LAN connection** or **Use the printer with wired LAN connection** according to the connection method you use. The printer is detected automatically in the network.

Make sure the printer was found, and install the printer driver following the on-screen instructions.

Note

- The network settings on the printer are not affected, so the printer can be used on the network without redoing settings.

Errors and Messages

- ▶ **An Error Occurs**
- ▶ **Message Appears**

An Error Occurs

If an error occurs in printing, for example if the paper runs out or jams, a troubleshooting message appears automatically. Take the appropriate action described in the message.

If an error occurs, a support code (error number) appears on the computer screen or the LCD.

When a Support Code and a Message Are Displayed on Computer Screen:

- For Windows:

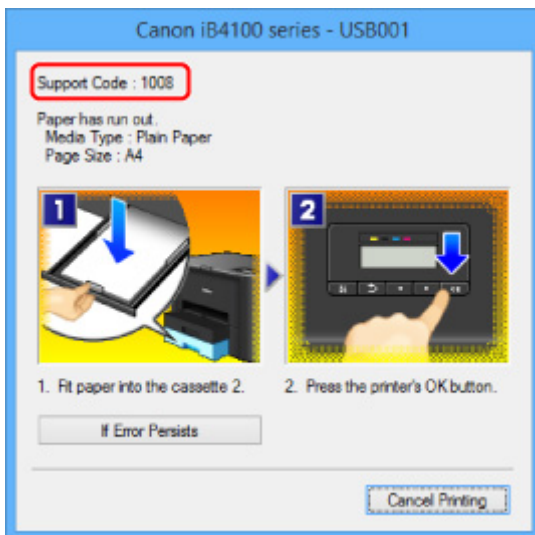

- For Mac OS:

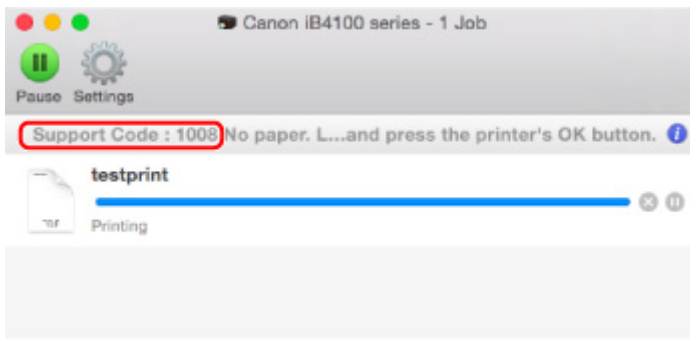

* The screen differs depending on the OS you are using.

When a Support Code and a Message Are Displayed on LCD:

No paper in cass. 2
Load paper in casse 1008

For more on resolving errors with support codes, see [List of Support Code for Error](#).

►►► Note

- You can also search for details on resolving the errors indicated by the support code shown.

■ [Search](#)

To resolve errors that do not have support codes, see [An Error Occurs](#).

Message Appears

This section describes some of the errors and messages that may appear.

►►► Note

- A support code (error number) is displayed on the computer or on the LCD for some errors. For details on errors that have support code, see [List of Support Code for Error](#).

If a message appears on the LCD, see below.

■ [Message Appears on LCD](#)

If a message appears on the computer, see below.

- [Error Regarding Automatic Duplex Printing Is Displayed](#)
- [Error Regarding Power Cord Being Unplugged Is Displayed \(Windows\)](#)
- [Writing Error/Output Error/Communication Error \(Windows\)](#)
- [Other Error Messages \(Windows\)](#)
- [Inkjet Printer/Scanner/Fax Extended Survey Program Screen Is Displayed \(Windows\)](#)
- [Inkjet Printer/Scanner/Fax Extended Survey Program Icon Appears \(Mac OS\)](#)

Message Appears on LCD

Check the message and take an appropriate action.

- **Cannot connect to the server; try again**

The printer cannot connect to the server due to a communication error.

Press the **OK** button and try again after a while.

Error Regarding Automatic Duplex Printing Is Displayed

Check See [Automatic Duplex Printing Problems](#) and take the appropriate action.

Error Regarding Power Cord Being Unplugged Is Displayed (Windows)

The printer may have been unplugged while it was on.

Check the error message that appears on the computer and click **OK**.

The printer starts printing.

See [Unplugging the Printer](#) for unplugging the power cord.

Writing Error/Output Error/Communication Error (Windows)

A

Check1 If **POWER** lamp is off, make sure printer is plugged in and turn it on.

The **POWER** lamp flashes while the printer is initializing. Wait until the **POWER** lamp stops flashing and remains lit.

Check2 Make sure correct printer port is set in printer driver.

* In the following instructions, "XXX" signifies your printer's name.

1. Log in using an account with administrator privileges.
2. Make the following settings.
 - In Windows 10, right-click **Start** button and select **Control Panel > View devices and printers**.
 - In Windows 8.1 or Windows 8, select **Control Panel** from **Settings** charm on **Desktop > Hardware and Sound > Devices and Printers**.
 - In Windows 7, select **Devices and Printers** from **Start** menu.
 - In Windows Vista, select **Start** menu > **Control Panel > Hardware and Sound > Printers**.
3. Open printer driver properties.
 - In Windows 10, Windows 8.1, Windows 8, or Windows 7, right-click "Canon XXX series" icon (where "XXX" is your printer's name), and then select **Printer properties**.
 - In Windows Vista, right-click "Canon XXX series" icon (where "XXX" is your printer's name), and then select **Properties**.
4. Click **Ports** tab to check port settings.

Make sure a port named "USBnnn" (where "n" is a number) with "Canon XXX series" appearing in **Printer** column is selected for **Print to the following port(s)**.

- If setting is incorrect:

Reinstall the printer driver from the Setup CD-ROM or the Canon website.
- If printing does not start even though the printer is connected to the computer using a USB cable and the port named "USBnnn" is selected:

In Windows 8.1 or Windows 8, select **My Printer** on **Start** screen to start **My Printer**. If **My Printer** is not displayed on **Start** screen, select **Search** charm, and then search for "**My Printer**".

Set the correct printer port on **Diagnose and Repair Printer**. Follow the on-screen instructions to set the correct printer port, and then select your printer's name.

In Windows 7 or Windows Vista, click **Start** and select **All programs, Canon Utilities, Canon My Printer, Canon My Printer**, and then select **Diagnose and Repair Printer**. Follow the on-screen instructions to set the correct printer port, and then select your printer's name.

If the problem is not resolved, reinstall the printer driver from the Setup CD-ROM or the Canon website.

Check3 Make sure printer is properly connected to computer.

If you are using a USB cable, make sure it is securely connected to both the printer and the computer. When the USB cable is securely plugged in, check the following:

- If you are using a relay device such as a USB hub, disconnect it, connect the printer directly to the computer, and retry the printing. If printing starts normally, there is a problem with the relay device. Contact the vendor of the relay device.
- There could also be a problem with the USB cable. Replace the USB cable and retry the printing.

If you use the printer over a LAN, make sure the printer is connected to the network with a LAN cable or is correctly set up for network use.

Check4 Make sure printer driver are installed correctly.

Uninstall the printer driver following the procedure described in [Deleting the Unnecessary Printer Driver](#) and reinstall them from the Setup CD-ROM or the Canon website.

Check5 When printer is connected to your computer with a USB cable, check device status from your computer.

Follow the procedure below to check the device status.

1. Open the Device Manager on your computer as shown below.

If the **User Account Control** screen appears, follow the on-screen instructions.

- In Windows 10, right-click **Start** button and select **Device Manager**.
- In Windows 8.1 or Windows 8, select **Control Panel** from **Settings** charm on **Desktop > Hardware and Sound > Device Manager**.
- In Windows 7 or Windows Vista, click **Control Panel, Hardware and Sound, and Device Manager**.

2. Double-click **Universal Serial Bus controllers** and **USB Printing Support**.

If the **USB Printing Support Properties** screen does not appear, make sure the printer is correctly connected to the computer.

 **Check3** [Make sure printer is properly connected to computer.](#)

3. Click **General** tab and check for a device problem.

If a device error is shown, see Windows Help to resolve it.

Other Error Messages (Windows)

Check If an error message appears outside printer status monitor, check the following:

- **"Could not spool successfully due to insufficient disk space"**
Delete any unnecessary files to increase the amount of free space on the disk.
- **"Could not spool successfully due to insufficient memory"**
Close other applications to increase the available memory.

If you still cannot print, restart your computer and retry the printing.

- **"Printer driver could not be found"**

Uninstall the printer driver following the procedure described in [Deleting the Unnecessary Printer Driver](#) and reinstall them from the Setup CD-ROM or the Canon website.

- **"Could not print Application name - File name"**

Try printing again once the current job is complete.

Q Inkjet Printer/Scanner/Fax Extended Survey Program Screen Is Displayed (Windows)

A

If the Inkjet Printer/Scanner/Fax Extended Survey Program is installed, a screen appears asking for permission to send the printer and application usage information every month for about ten years.

Read the information on the screen and follow the instructions below.

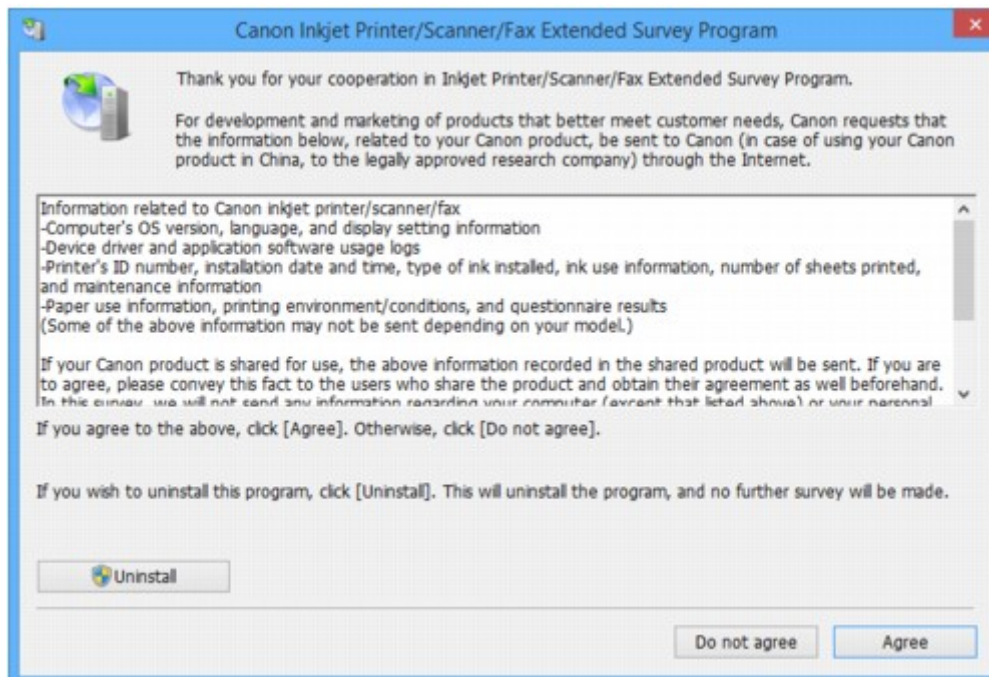

- **If you agree to participate in survey program:**

Click **Agree** and follow the on-screen instructions. The printer usage information is sent via the Internet. Once you have completed the procedure, the information is subsequently sent automatically and the confirmation screen does not reappear.

»»» Note

- When the information is being sent, a warning such as an Internet security message may appear. Make sure the program name is "IJPLMUI.exe" and allow it.
- If you clear **Send automatically from the next time** check box, the information will not be sent automatically from next time and a confirmation screen will appear at the time of the next survey. To send the information automatically, see [Changing confirmation screen setting:](#)

- **If you do not agree to participate in survey program:**

Click **Do not agree**. The confirmation screen closes and the survey is skipped. The confirmation screen will reappear one month later.

- **To uninstall Inkjet Printer/Scanner/Fax Extended Survey Program:**

To uninstall the Inkjet Printer/Scanner/Fax Extended Survey Program, click **Uninstall** and follow the on-screen instructions.

- **Changing confirmation screen setting:**

1. Make the following settings.

- In Windows 10, right-click **Start** button and select **Programs and Features**.
- In Windows 8.1 or Windows 8, select **Control Panel** from **Settings** charm on **Desktop** > **Programs** > **Programs and Features**.
- In Windows 7, or Windows Vista, select **Start** menu > **Control Panel** > **Programs** > **Programs and Features**.

»» Note

- A confirmation/warning dialog box may appear when installing, uninstalling or starting up software.

This dialog box appears when administrative rights are required to perform a task.

If you are logged in on an account with administrator privileges, follow the on-screen instructions.

2. Select **Canon Inkjet Printer/Scanner/Fax Extended Survey Program**.

3. Select **Change**.

If you select **Yes** after you have followed the on-screen instructions, the confirmation screen will appear at the time of the next survey.

If you select **No**, the information will be sent automatically.

»» Note

- If you select **Uninstall**, the Inkjet Printer/Scanner/Fax Extended Survey Program is uninstalled. Follow the on-screen instructions.

Inkjet Printer/Scanner/Fax Extended Survey Program Icon Appears (Mac OS)

Answer

If the Inkjet Printer/Scanner/Fax Extended Survey Program is installed, the printer and application software usage information is sent every month for about ten years. The **Inkjet Printer/Scanner/Fax Extended Survey Program** icon appears in the Dock when it is time to send the printer usage information.

Click the icon, read the information that appears, and then follow the instructions below.

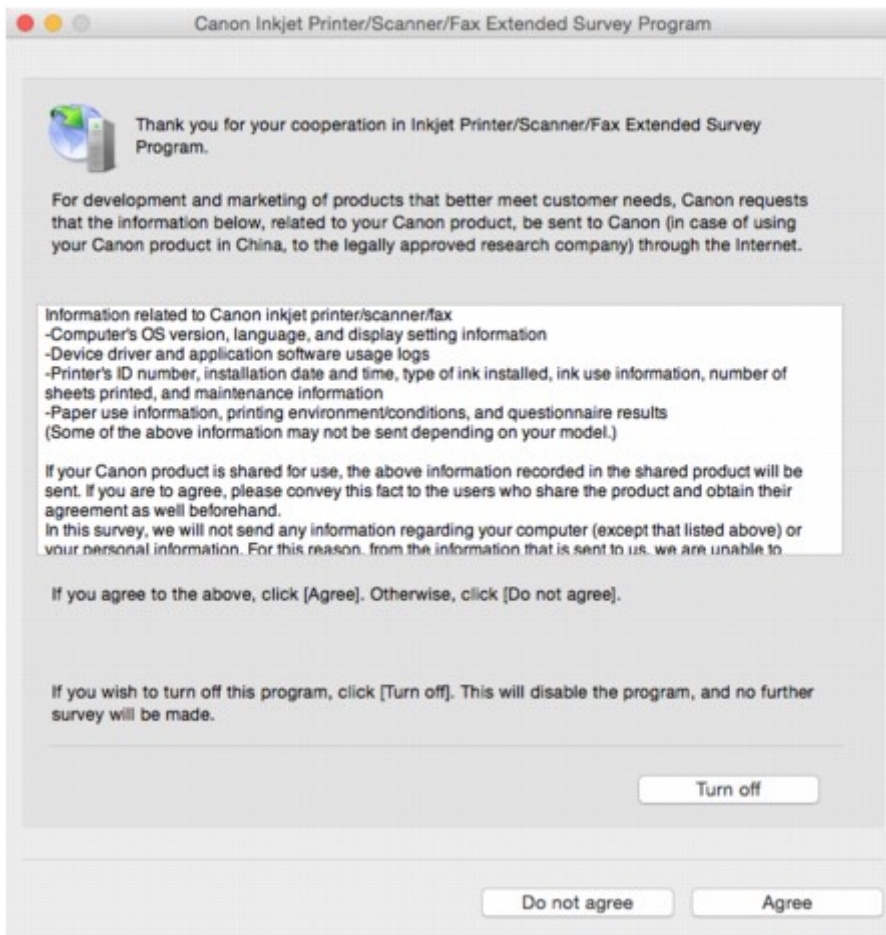

- **If you agree to participate in survey program:**

Click **Agree** and follow the on-screen instructions. The printer usage information is sent via the Internet. Once you have completed the procedure, the information is subsequently sent automatically and the confirmation screen does not reappear.

▶▶▶ **Note**

- If you clear **Send automatically from the next time** check box, the information will not be sent automatically the next time and the **Inkjet Printer/Scanner/Fax Extended Survey Program** icon will appear in the dock at the time of the next survey.

- **If you do not agree to participate in survey program:**

Click **Do not agree**. The confirmation screen closes and the survey is skipped. The confirmation screen will reappear one month later.

- **To stop sending information:**

Click **Turn off**. This stops the Inkjet Printer/Scanner/Fax Extended Survey Program, and information is not sent. To resume the survey, see [Changing setting](#).

- **To uninstall Inkjet Printer/Scanner/Fax Extended Survey Program:**

1. Stop Inkjet Printer/Scanner/Fax Extended Survey Program.

■ [Changing setting](#):

2. Select **Applications** from **Go** menu of Finder, double-click **Canon Utilities** folder and **Inkjet Extended Survey Program** folder.
3. Move **Canon Inkjet Printer/Scanner/Fax Extended Survey Program.app** file to **Trash**.
4. Restart computer.
Empty **Trash** and restart your computer.

- **Changing setting:**

To display the confirmation screen every time the printer usage information is sent or to resume surveying, follow the procedure below.

1. Select **Applications** from **Go** menu of Finder, double-click **Canon Utilities** folder and **Inkjet Extended Survey Program** folder.
2. Double-click **Canon Inkjet Printer/Scanner/Fax Extended Survey Program** icon.

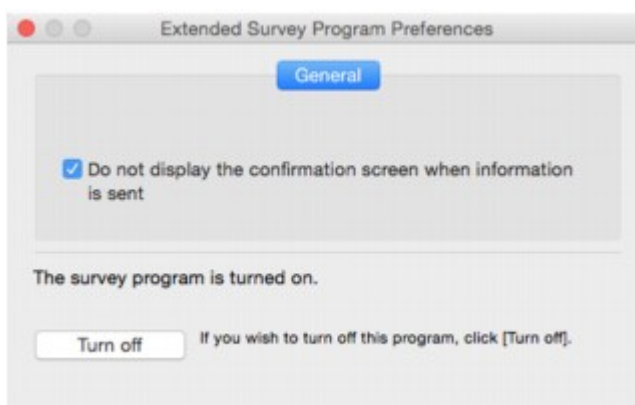

- **Do not display the confirmation screen when information is sent:**

If the check box is selected, the information will be sent automatically.

If the check box is not selected, **Inkjet Printer/Scanner/Fax Extended Survey Program** icon will appear in the Dock at the time of the next survey. Click the icon and follow the on-screen instructions.

- **Turn off/Turn on** button:

Click the **Turn off** button to stop the Inkjet Printer/Scanner/Fax Extended Survey Program.

Click the **Turn on** button to restart the Inkjet Printer/Scanner/Fax Extended Survey Program.

If You Cannot Solve a Problem

If there is a problem that you cannot solve following the instructions in this chapter, contact Canon through the Support page of the Canon website or contact your nearest Canon service center.

Canon support staff are trained to be able to provide technical support to satisfy customers.

Caution

- If the printer emits any unusual sound, smoke, or odor, turn it off immediately. Unplug the printer and contact the seller you bought it from or your nearest Canon service center. Never attempt to repair or disassemble the printer yourself.
- If you attempt to repair or take apart the printer, your warranty will be invalidated even if it has not expired.

Before contacting the service center, note the following:

- Product name
(Your printer's name is written on the front cover of the setup manual.)
- Serial number (see setup manual)
- Details of problem
- What you tried to solve the problem, and what happened

List of Support Code for Error

Support code appears on the LCD and your computer screen when errors occur.

A "support code" is an error number, and appears along with an error message.

When an error occurs, check the support code displayed on the LCD and computer screen and take the appropriate action in response.

Support Code Appears on LCD and Computer Screen

- **1000 to 1ZZZ**

[1007](#) [1008](#) [1200](#) [1300](#) [1303](#) [1309](#)

[1310](#) [1313](#) [1314](#) [1319](#) [1575](#) [1600](#)

[1660](#) [1688](#) [1700](#) [1701](#) [1754](#) [1755](#)

[1872](#) [1873](#) [1874](#) [1890](#)

- **2000 to 2ZZZ**

[2111](#) [2112](#) [2113](#) [2121](#) [2122](#) [2500](#)

- **3000 to 3ZZZ**

[3413](#) [3426](#) [3427](#) [3428](#) [3429](#) [3430](#)

[3431](#) [3432](#) [3433](#)

- **4000 to 4ZZZ**

[4100](#) [4103](#) [4104](#)

- **5000 to 5ZZZ**

[5100](#) [5102](#) [5103](#) [5104](#) [5105](#) [5200](#)

[5203](#) [5204](#) [5205](#) [5206](#) [5207](#) [5208](#)

[5209](#) [5400](#) [5500](#) [5501](#) [5B00](#) [5B01](#)

[5C01](#)

- **6000 to 6ZZZ**

[6000](#) [6500](#) [6502](#) [6800](#) [6801](#) [6900](#)

[6901](#) [6902](#) [6910](#) [6911](#) [6920](#) [6921](#)

[6930](#) [6931](#) [6932](#) [6933](#) [6940](#) [6941](#)

[6942](#) [6943](#) [6944](#) [6945](#) [6946](#)

• **7000 to 7ZZZ**

[7100](#) [7200](#) [7201](#) [7202](#) [7203](#) [7204](#)

[7205](#)

• **A000 to ZZZZ**

[B202](#) [B203](#) [B204](#) [B205](#) [B502](#) [B503](#)

[B504](#) [C000](#)

For paper jam support codes, see also [List of Support Code for Error \(Paper Jams\)](#).

List of Support Code for Error (Paper Jams)

If paper jams, remove it following the appropriate procedure as shown below.

- If the paper is jammed inside the front cover:
 - [1300](#)
- If the paper is jammed inside the rear cover:
 - [1303](#)
- If the paper is jammed inside the rear cover as the printer pulled in the printed paper:
 - [1313](#)
- If the paper is jammed inside the rear cover during automatic duplex printing:
 - [1314](#)
- Cases other than above:
 - [Other Cases](#)

1300

Cause

Paper is jammed inside front cover.

What to Do

If the paper is jammed inside the front cover, remove the paper by following these steps.

▶▶▶ Note

- If paper becomes jammed during printing and you need to turn off the printer to remove it, press the **Stop** button to stop the printing before you turn off the printer.

1. Open front cover.

▶▶▶ Important

- Do not touch clear film (A) or white belt (B).

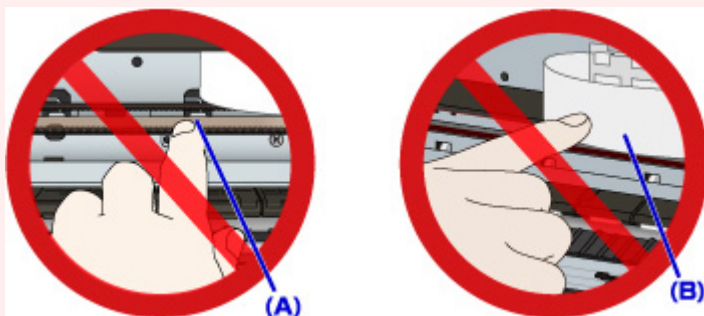

If you soil or scratch these parts by touching them with paper or your hand, it could damage the printer.

2. Make sure jammed paper is not under print head holder.

If the jammed paper is under the print head holder, move the print head holder to the far right or left, whichever makes it easier to remove the paper.

When moving the print head holder, press either the right side or the left side of the print head holder with your fingertips and slide it slowly to the far right or left.

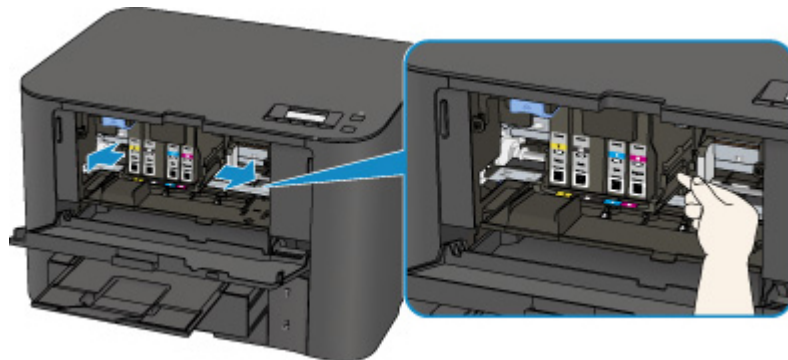

3. Hold jammed paper firmly in both hands.

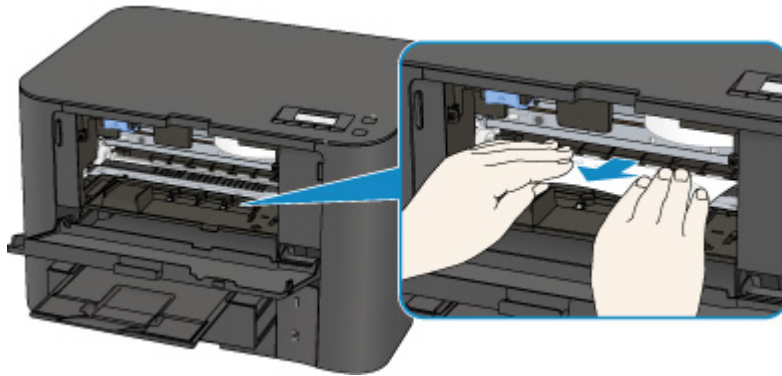

If the paper is rolled up, pull out it.

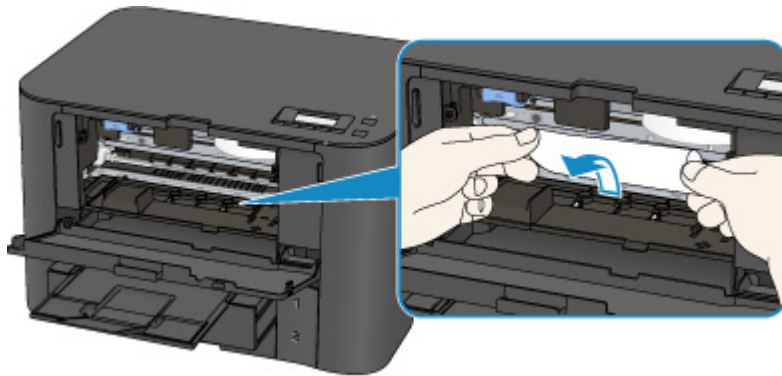

4. Pull paper out slowly, so as not to tear it.

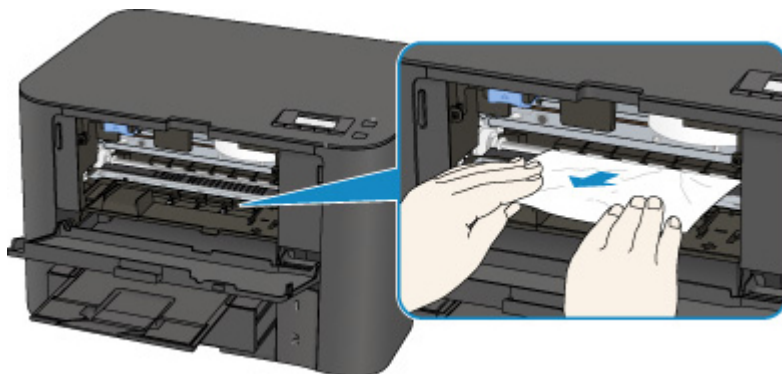

5. Make sure all jammed paper is removed.

If the paper tears when you pull out it, a bit of paper may remain in the printer. Check the following and remove any remaining paper.

- Any paper left under the print head holder?
- Any small bits of paper left in the printer?
- Any paper left in the left and right empty spaces (C) in the printer?

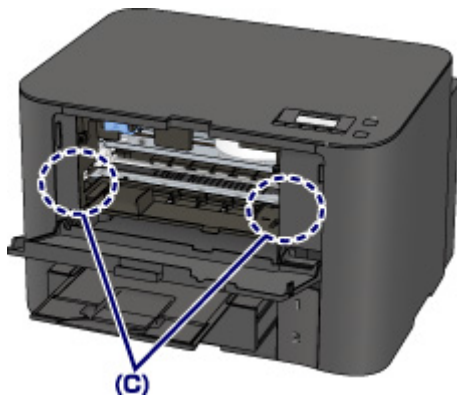

6. Close front cover.

7. Press printer's **OK** button.

If you turned off the printer, the print data that was sent to the printer is erased. Redo the printing.

▶▶▶ Note

- When reloading the paper, make sure you are using suitable paper and loading it correctly.
Align the paper guides with the both edges of the paper when you load paper.
- If the message about paper jam is displayed on the LCD of the printer or on the computer screen when you resume printing after removing all the jammed paper, a piece of paper may remain inside the printer. In this case, make sure no piece of paper remains inside the printer.
- We recommend using paper sizes other than A5/A6 to print documents with photos or graphics. A5/A6 paper may curl and jam as it leaves the printer.

If the measures above do not solve the problem, contact your nearest Canon service center to request a repair.

1303

Cause

Paper is jammed in rear cover.

What to Do

If the paper is jammed inside the rear cover, follow these steps to remove the paper.

▶▶▶ Note

- If paper becomes jammed during printing and you need to turn off the printer to remove it, press the **Stop** button to stop the printing before you turn off the printer.

1. Rotate printer so that rear side of printer faces toward you.

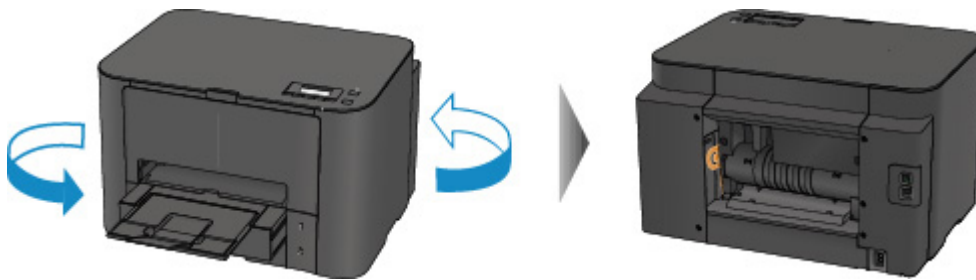

2. If protective material for rear cover remains attached, remove it.

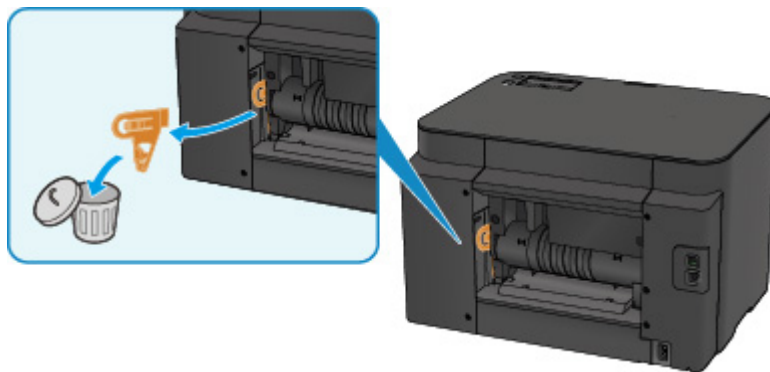

3. Open rear cover.

Slide the rear cover to the left then open it.

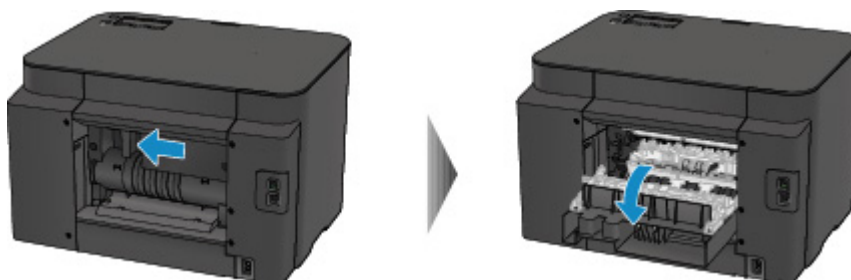

4. Pull out paper slowly.

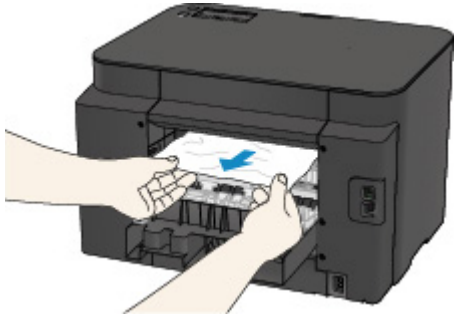

▶▶▶ **Note**

- Do not touch the inner parts of the printer.
- If you cannot pull the paper out, try the following.
 - Turn the printer off and turn it back on.
The paper may be ejected automatically.
 - Pull out the paper output tray.
It becomes easy to pull out the paper.

5. Close rear cover slowly.

Close the rear cover then slide it to the right.

Slide the rear cover so that the \triangle mark on the rear cover aligns with the ∇ mark on the printer.

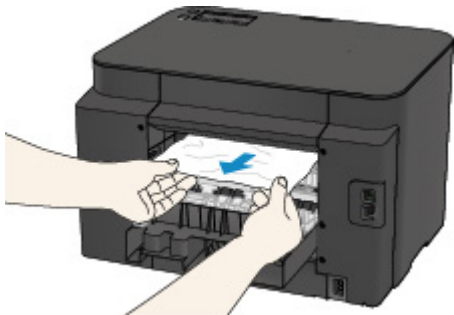

6. Reload paper and press printer's **OK** button.

If you turned off the printer, the print data that was sent to the printer is erased. Redo the printing.

▶▶▶ **Note**

- When reloading the paper, make sure you are using suitable paper and loading it correctly.
Align the paper guides with the both edges of the paper when you load paper.
- We recommend using paper sizes other than A5/A6 to print documents with photos or graphics.
A5/A6 paper may curl and jam as it leaves the printer.

If the measures above do not solve the problem, contact your nearest Canon service center to request a repair.

1313

Cause

Paper is jammed inside rear cover as printer pulled in printed paper.

What to Do

If the paper is jammed inside the rear cover as the printer pulled in the printed paper, remove the paper by following these steps.

▶▶▶ Important

- If the printed paper piles up on the paper output slot, the printer may pull it in and the paper is jammed inside the printer. Remove the printed paper from the paper output tray before it amounts to 75 sheets.

▶▶▶ Note

- If paper becomes jammed during printing and you need to turn off the printer to remove it, press the **Stop** button to stop the printing before you turn off the printer.

1. Rotate printer so that rear side of printer faces toward you.

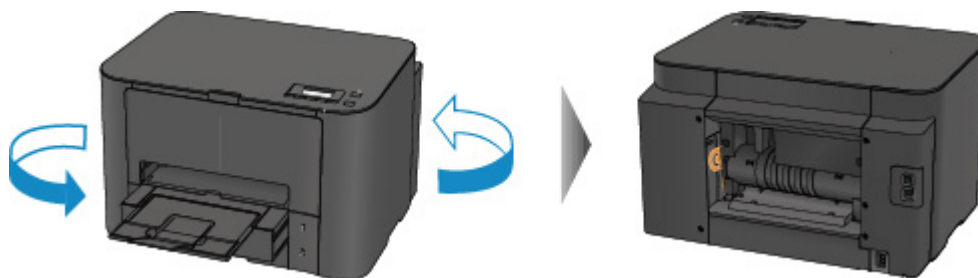

2. If protective material for rear cover remains attached, remove it.

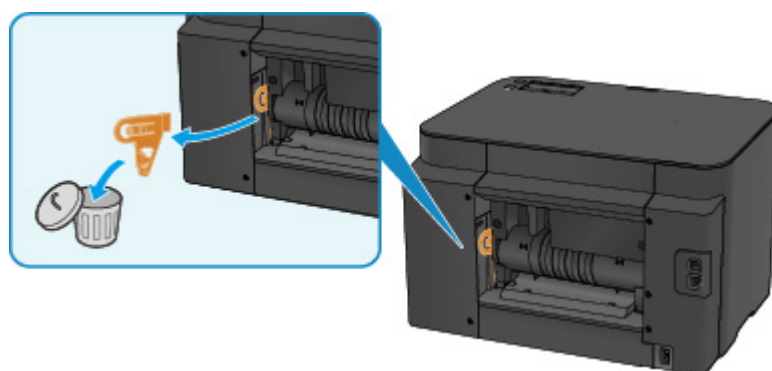

3. Open rear cover.

Slide the rear cover to the left then open it.

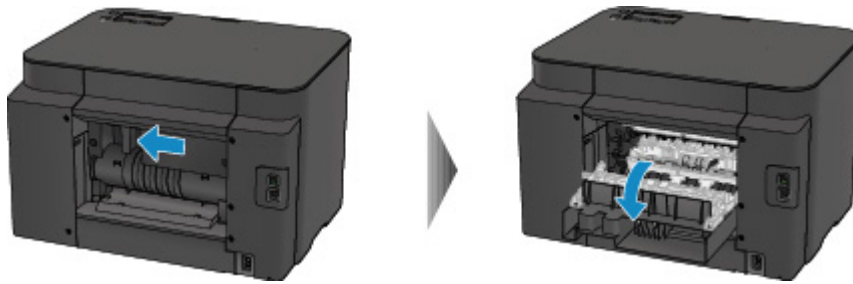

4. Pull out paper slowly.

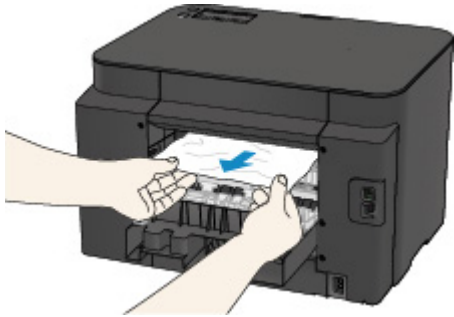

▶▶▶ Note

- Do not touch the inner parts of the printer.
- If you cannot pull the paper out, try the following.
 - Turn the printer off and turn it back on.
The paper may be ejected automatically.
 - Pull out the paper output tray.
It becomes easy to pull out the paper.

5. Close rear cover slowly.

Close the rear cover then slide it to the right.

Slide the rear cover so that the \triangle mark on the rear cover aligns with the ∇ mark on the printer.

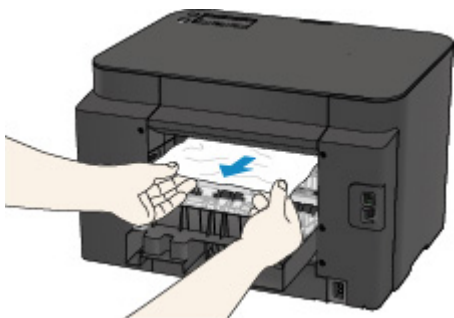

6. Reload paper and press printer's **OK** button.

If you turned off the printer, the print data that was sent to the printer is erased. Redo the printing.

▶▶▶ Note

- When reloading the paper, make sure you are using suitable paper and loading it correctly.

Align the paper guides with the both edges of the paper when you load paper.

If the measures above do not solve the problem, contact your nearest Canon service center to request a repair.

1314

Cause

Paper is jammed inside rear cover during automatic duplex printing.

What to Do

If the paper is jammed inside the rear cover when performing automatic duplex printing, remove the paper by following these steps.

▶▶▶ Note

- If paper becomes jammed during printing and you need to turn off the printer to remove it, press the **Stop** button to stop the printing before you turn off the printer.

1. Rotate printer so that rear side of printer faces toward you.

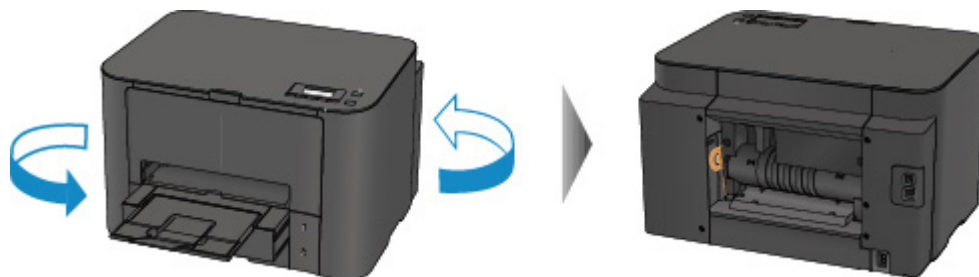

2. If protective material for rear cover remains attached, remove it.

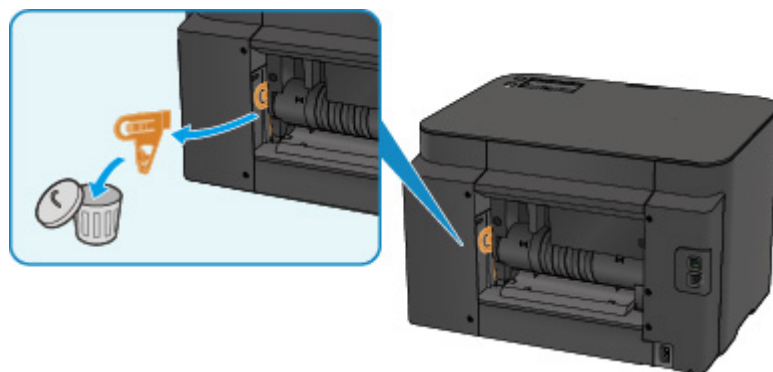

3. Open rear cover.

Slide the rear cover to the left then open it.

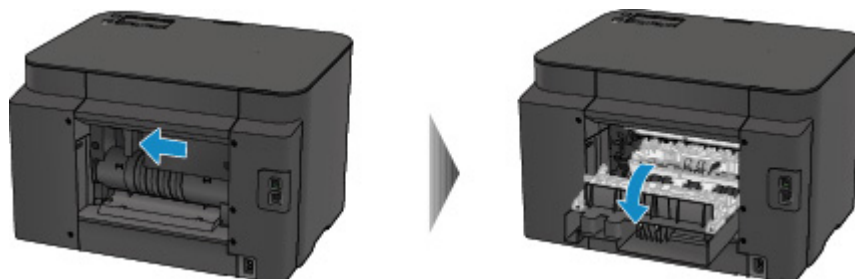

4. Pull out paper slowly.

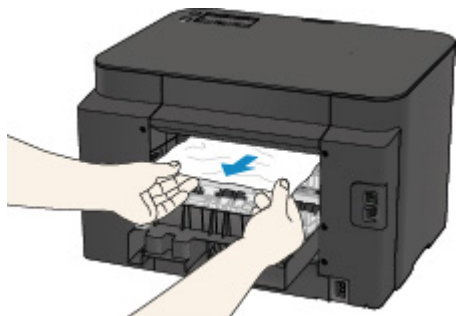

▶▶▶ **Note**

- Do not touch the inner parts of the printer.
- If you cannot pull the paper out, try the following.
 - Turn the printer off and turn it back on.
The paper may be ejected automatically.
 - Pull out the paper output tray.
It becomes easy to pull out the paper.

5. Close rear cover slowly.

Close the rear cover then slide it to the right.

Slide the rear cover so that the \triangle mark on the rear cover aligns with the ∇ mark on the printer.

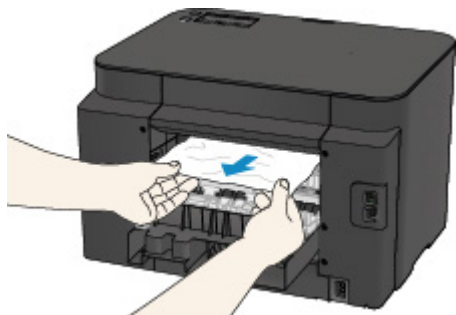

6. Reload paper and press printer's **OK** button.

If you turned off the printer, the print data that was sent to the printer is erased. Redo the printing.

▶▶▶ **Note**

- When reloading the paper, make sure you are using suitable paper and loading it correctly.
Align the paper guides with the both edges of the paper when you load paper.

If the measures above do not solve the problem, contact your nearest Canon service center to request a repair.

Other Cases

Check the following:

Check1 Is anything blocking paper output slot?

Check2 Are rear cover attached properly?

Check3 Is paper curled?

Correct curl before loading paper.

1007

Cause

Possible causes include the following.

- There is no paper in the cassette 1.
- Paper is not loaded in the cassette 1 properly.

What to Do

Take the corresponding actions below.

- Load paper in the cassette 1.
- Align the paper guides with the both edges of the paper when you load paper in the cassette 1.

After carrying out the above measures, press the **OK** button.

▶▶ Note

- The loadable paper differs depending on the paper source.
A4, Letter, Legal, Oficio, B-Oficio, M-Oficio, Foolscap, or Legal (India)-sized plain paper can be loaded in both the cassette 1 and the cassette 2.
- To cancel printing, press the printer's **Stop** button.

1008

Cause

Possible causes include the following.

- There is no paper in the cassette 2.
- Paper is not loaded in the cassette 2 properly.

What to Do

Take the corresponding actions below.

- Load paper in the cassette 2.
- Align the paper guides with the both edges of the paper when you load paper in the cassette 2.

After carrying out the above measures, press the **OK** button.

▶▶ Important

- The loadable paper differs depending on the paper source.

The loadable paper in the cassette 2 is A4, Letter, Legal, Oficio, B-Oficio, M-Oficio, Foolscap, or Legal (India)-sized plain paper.

▶▶ Note

- To cancel printing, press the printer's **Stop** button.

1200

Cause

Front cover is open.

What to Do

Close the front cover and wait for a while.

Do not close it while you are replacing an ink tank.

1309

Cause

Paper size that is not compatible with automatic duplex printing is specified.

What to Do

The sizes of media suitable for auto duplex printing are A4 and Letter.

Press the printer's **Stop** button to cancel printing.

Then change the print settings and retry printing.

1310

Cause

Size of paper may not be compatible with automatic duplex printing.

What to Do

The sizes of media suitable for auto duplex printing are A4 and Letter. Make sure paper of the correct size is loaded. Press the **OK** button to eject the paper and restart printing from the front of the next piece of paper. The reverse side of the ejected sheet is not printed.

1319

Cause

Size of paper is not compatible with automatic duplex printing.

What to Do

The sizes of media suitable for auto duplex printing are A4 and Letter.

Press the printer's **Stop** button to cancel printing.

Then change the print settings and retry printing.

1575

Cause

Ink cannot be correctly detected.

What to Do

If an ink tank becomes empty, replace it.

An ink tank cannot be replaced until it becomes empty.

Please be advised that Canon shall not be liable for any malfunction or trouble caused by continuation of printing under the ink out condition.

1600

Cause

Ink may have run out.

What to Do

Replacing the ink tank is recommended.

If printing is in progress and you want to continue printing, press the machine's **OK** button with the ink tank installed. Then printing can continue. Replacing the ink tank is recommended after the printing. The machine may be damaged if printing is continued under the ink out condition.

Important

- Do not remove an ink tank until a new one is prepared to be installed.
 - Once you remove an ink tank, the machine will not operate until a new one is installed.
 - Once you remove an ink tank, the machine will not operate even if the removed ink tank is just reinstalled.

1660

Cause

An ink tank is not installed.

What to Do

Install the ink tank.

1688

Cause

The ink has run out.

What to Do

Replace the ink tank and close the front cover.

Printing under the current condition may damage the machine.

If you want to continue printing in this condition, you need to disable the function for detecting the remaining ink level. Press and hold the machine's **Stop** button for at least 5 seconds, and then release it.

With this operation, disabling the function for detecting the remaining ink level is memorized. Please be advised that Canon shall not be liable for any malfunction or trouble caused by continuation of printing under the ink out condition.

▶▶▶ Important

- Do not remove an ink tank until a new one is prepared to be installed.
 - Once you remove an ink tank, the machine will not operate until a new one is installed.
 - Once you remove an ink tank, the machine will not operate even if the removed ink tank is just reinstalled.

1700

Cause

Ink absorber is almost full.

What to Do

Press the printer's **OK** button to continue printing. Contact your nearest Canon service center to request a repair.

1701

Cause

Ink absorber is almost full.

What to Do

Press the printer's **OK** button to continue printing. Contact your nearest Canon service center to request a repair.

1754

Cause

The ink tank is not installed properly.

What to Do

Open the front cover.

Then push the ink tank.

After installing the ink tank properly, close the front cover.

If this does not solve the problem, contact your nearest Canon service center to request a repair.

▶▶ Important

- The ink tank that was once installed cannot be removed until the ink runs out.

1755

Cause

The ink has run out.

What to Do

To maintain both machine and print quality, the machine cannot continue printing under the ink out condition.

Cancel printing and replace the ink tank before printing again.

»» Important

- Do not remove an ink tank until a new one is prepared to be installed.
 - Once you remove an ink tank, the machine will not operate until a new one is installed.
 - Once you remove an ink tank, the machine will not operate even if the removed ink tank is just reinstalled.

1872

Cause

Cassette 1 is not inserted.

What to Do

Insert the cassette 1.

▶▶ Note

- Once the cassette 1 is installed, the screen for setting cassette paper information appears. Set the paper information for the paper in the cassette 1.
- To cancel printing, press the printer's **Stop** button.

1873

Cause

Cassette 2 is not inserted.

What to Do

Insert the cassette 2.

▶▶ Note

- Once the cassette 2 is installed, the screen for setting cassette paper information appears. Set the paper information for the paper in the cassette 2.
- To cancel printing, press the printer's **Stop** button.

1874

Cause

Cassette 1 and cassette 2 are not inserted.

What to Do

Insert the both cassettes.

▶▶ Note

- Once the cassette is installed, the screen for setting cassette paper information appears. Set the paper information for the paper in the cassette 1 and the cassette 2.
- To cancel printing, press the printer's **Stop** button.

1890

Cause

Protective material or tape may still be attached to print head holder.

What to Do

Open the front cover and make sure the protective material and tape have been removed from the print head holder.

If the protective material or tape is still there, remove it and close the front cover.

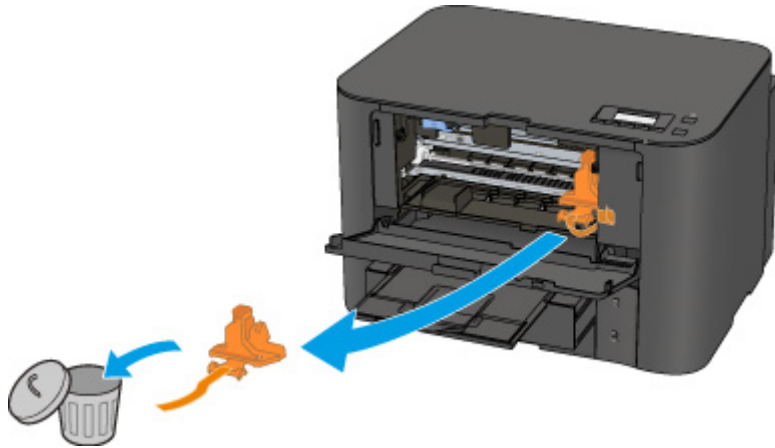

If this does not solve the problem, contact your nearest Canon service center to request a repair.

2111

Cause

Paper settings for printing differ from cassette paper information set on printer.

▶▶▶ Note

- See below for the correct correspondence between paper settings made on the printer driver or on the LCD.
 - [Paper Settings on the Printer Driver and the Printer \(Media Type\) \(Windows\)](#)
 - Paper Settings on the Printer Driver and the Printer (Media Type) (Mac OS)
 - [Paper Settings on the Printer Driver and the Printer \(Paper Size\) \(Windows\)](#)
 - Paper Settings on the Printer Driver and the Printer (Paper Size) (Mac OS)
- See below for more on the cassette paper information that is set on the printer.
 - [Paper Settings](#)

If the print paper settings do not match the cassette paper information set on the printer, as shown below, a message appears on the LCD.

- Print settings specified on the printer driver:
 - Paper size: A5
 - Media type: Plain paper
- Cassette paper information set on the printer:
 - Paper size: A4
 - Media type: Plain paper

```
Size/type of paper 2111  
[OK]Select option
```

What to Do

Pressing the printer's **OK** button, the screen below appears.

```
Select option  
Use cass. settings ▶
```

Select the appropriate action.

▶▶▶ Note

- All of the options below may not appear, depending on the setting.

Use cass. settings

Select this option to print on the paper in the cassette 1, without changing the paper settings.

For example, if the paper setting is A5, and A4 is set in the cassette paper information, the A5 size setting is used to print on the A4 paper in the cassette 1.

Replace the paper

Select this option to print after changing the paper in the cassette 1.

For example, if the paper setting is A5, and A4 is set in the cassette paper information, change the paper in the cassette 1 to A5 paper and proceed with printing.

Once you have changed the paper, the screen for setting the cassette paper information appears. Set the paper information for the paper in the cassette 1.

▶▶▶ Note

- If you do not know what paper information to set, press the **Back** button. The previous screen appears, showing the paper size and media type. Check the paper settings and set them as the cassette paper information.
- See below for the correct correspondence between paper settings made on the printer driver or on the LCD.

- [Paper Settings on the Printer Driver and the Printer \(Media Type\)](#) (Windows)

- Paper Settings on the Printer Driver and the Printer (Media Type) (Mac OS)

- [Paper Settings on the Printer Driver and the Printer \(Paper Size\)](#) (Windows)

- Paper Settings on the Printer Driver and the Printer (Paper Size) (Mac OS)

Cancel printing

Cancels printing.

Select this option to change the print paper settings. Change the paper settings and retry the printing.

▶▶▶ Note

- To suppress the misprint prevention message, change the setting as described below. When you suppress the message, the printer uses the paper settings to print on the paper in the cassette 1, even if the paper does not match the settings.

- To change the message view setting when printing using the operation panel of the printer:

- [Cassette settings](#)

- To change the message view setting when printing using the printer driver:

- [Changing the Printer Operation Mode](#) (Windows)

- Changing the Printer Operation Mode (Mac OS)

2112

Cause

Paper settings for printing differ from cassette paper information set on printer.

▶▶▶ Note

- See below for the correct correspondence between paper settings made on the printer driver or on the LCD.
 - [Paper Settings on the Printer Driver and the Printer \(Media Type\) \(Windows\)](#)
 - Paper Settings on the Printer Driver and the Printer (Media Type) (Mac OS)
 - [Paper Settings on the Printer Driver and the Printer \(Paper Size\) \(Windows\)](#)
 - Paper Settings on the Printer Driver and the Printer (Paper Size) (Mac OS)
- See below for more on the cassette paper information that is set on the printer.
 - [Paper Settings](#)

If the print paper settings do not match the cassette paper information set on the printer, as shown below, a message appears on the LCD.

- Print settings specified on the printer driver:
 - Paper size: A4
 - Media type: Plain paper
- Cassette paper information set on the printer:
 - Paper size: Legal
 - Media type: Plain paper

```
Size/type of paper 2112
[OK]Select option
```

What to Do

Pressing the printer's **OK** button, the screen below appears.

```
Select option
Use cass. settings ▶
```

Select the appropriate action.

▶▶▶ Note

- All of the options below may not appear, depending on the setting.

Use cass. settings

Select this option to print on the paper in the cassette 2, without changing the paper settings.

For example, if the paper setting is A4, and Legal is set in the cassette paper information, the A4 size setting is used to print on the Legal paper in the cassette 2.

Replace the paper

Select this option to print after changing the paper in the cassette 2.

For example, if the paper setting is A4, and Legal is set in the cassette paper information, change the paper in the cassette 2 to A4 paper and proceed with printing.

Once you have changed the paper, the screen for setting the cassette paper information appears. Set the paper information for the paper in the cassette 2.

▶▶▶ Note

- If you do not know what paper information to set, press the **Back** button. The previous screen appears, showing the paper size and media type. Check the paper settings and set them as the cassette paper information.
- See below for the correct correspondence between paper settings made on the printer driver or on the LCD.

- [Paper Settings on the Printer Driver and the Printer \(Media Type\)](#) (Windows)
- Paper Settings on the Printer Driver and the Printer (Media Type) (Mac OS)
- [Paper Settings on the Printer Driver and the Printer \(Paper Size\)](#) (Windows)
- Paper Settings on the Printer Driver and the Printer (Paper Size) (Mac OS)

Cancel printing

Cancels printing.

Select this option to change the print paper settings. Change the paper settings and retry the printing.

▶▶▶ Note

- To suppress the misprint prevention message, change the setting as described below. When you suppress the message, the printer uses the paper settings to print on the paper in the cassette 2, even if the paper does not match the settings.
 - To change the message view setting when printing using the operation panel of the printer:
 - [Cassette settings](#)
 - To change the message view setting when printing using the printer driver:
 - [Changing the Printer Operation Mode](#) (Windows)
 - Changing the Printer Operation Mode (Mac OS)

2113

Cause

Paper settings for printing differ from cassette paper information set on printer.

▶▶▶ Note

- See below for the correct correspondence between paper settings made on the printer driver or on the LCD.
 - [Paper Settings on the Printer Driver and the Printer \(Media Type\) \(Windows\)](#)
 - Paper Settings on the Printer Driver and the Printer (Media Type) (Mac OS)
 - [Paper Settings on the Printer Driver and the Printer \(Paper Size\) \(Windows\)](#)
 - Paper Settings on the Printer Driver and the Printer (Paper Size) (Mac OS)
- See below for more on the cassette paper information that is set on the printer.
 - [Paper Settings](#)

If the print paper settings do not match the cassette paper information set on the printer, as shown below, a message appears on the LCD.

- Print settings specified on the printer driver:
 - Paper size: A4
 - Media type: Plain paper
- Cassette paper information set on the printer:
 - Paper size: Legal
 - Media type: Plain paper

```
Size or type of load 2113  
[OK]Select option
```

What to Do

Pressing the printer's **OK** button, the screen below appears.

```
Select option  
Use cass. settings ▶
```

Select the appropriate action.

▶▶▶ Note

- All of the options below may not appear, depending on the setting.

Use cass. settings

Select this option to print on the paper in the cassette 1 and the cassette 2, without changing the paper settings.

For example, if the paper setting is A4, and Legal is set in the cassette paper information, the A4 size setting is used to print on the Legal paper in the cassette 1 and the cassette 2.

Replace the paper

Select this option to print after changing the paper in the cassette 1 and the cassette 2.

For example, if the paper setting is A5, and A4 is set in the cassette paper information, change the paper in the cassette 1 and the cassette 2 to A5 paper and proceed with printing.

Once you have changed the paper, the screen for setting the cassette paper information appears. Set the paper information for the paper in the cassette 1 and in cassette 2.

▶▶▶ Note

- If you do not know what paper information to set, press the **Back** button. The previous screen appears, showing the paper size and media type. Check the paper settings and set them as the cassette paper information.
- See below for the correct correspondence between paper settings made on the printer driver or on the LCD.

- [Paper Settings on the Printer Driver and the Printer \(Media Type\)](#) (Windows)

- Paper Settings on the Printer Driver and the Printer (Media Type) (Mac OS)

- [Paper Settings on the Printer Driver and the Printer \(Paper Size\)](#) (Windows)

- Paper Settings on the Printer Driver and the Printer (Paper Size) (Mac OS)

Cancel printing

Cancels printing.

Select this option to change the print paper settings. Change the paper settings and retry the printing.

▶▶▶ Note

- To suppress the misprint prevention message, change the setting as described below. When you suppress the message, the printer uses the paper settings to print on the paper in the cassette 1 and in the cassette 2, even if the paper does not match the settings.

- To change the message view setting when printing using the operation panel of the printer:

- [Cassette settings](#)

- To change the message view setting when printing using the printer driver:

- [Changing the Printer Operation Mode](#) (Windows)

- Changing the Printer Operation Mode (Mac OS)

2121

Cause

Cassette 1 paper settings are incomplete.

What to Do

If screen below is shown, the cassette 1 paper settings are incomplete.



Size: ◀ *A4 ▶
Type: *Plain paper

Press the printer's **OK** button to finish setting the cassette 1 paper settings.

2122

Cause

Cassette 2 paper settings are incomplete.

What to Do

If screen below is shown, the cassette 2 paper settings are incomplete.



Size: ◀ *A4 ▶
Type: *Plain paper

Press the printer's **OK** button to finish setting the cassette 1 paper settings.

2500

Cause

Cause of following may have occurred failure of automatic print head alignment.

- Print head nozzles are clogged.
- Paper of size other than A4 or Letter is loaded in the cassette 1.
- Paper output slot is exposed to strong light.

What to Do

Press the printer's **OK** button and take the corresponding actions below.

- Check the print head condition by printing the nozzle check pattern.
- Load one sheet of A4/Letter-sized plain paper in the cassette 1 and perform automatic print head alignment again.

For automatic print head alignment, always load paper in the cassette 1.

- Adjust your operating environment and/or the position of the printer so that the paper output slot is not exposed directly to strong light.

After carrying out the above measures, if the problem continues after aligning the print head again, press the printer's **OK** button, and then perform manual print head alignment.

3413

Cause

Prevent paper abrasion has been set.

What to Do

If you continue printing in the current setting, select **Continue printing** and press the **OK** button.

Prevent paper abrasion may reduce the print speed.

If you disable this setting, select **Do not print** and press the **OK** button. Press the **Setup** button, and then select **Device settings** and **Output settings** in this order and set **Prevent abrasion** to **OFF**.

3426

Cause

First side printing is complete when manual duplex printing.

What to Do

Prepare to print the other side.

Keeping the printed side facing up, rotate the paper 180 degrees so that the front edge of the printed paper faces away from you and fit the paper back into the cassette 1.

When ready, press the printer's **OK** button.

3427

Cause

First side printing is complete when manual duplex printing.

What to Do

Prepare to print the other side.

Keeping the printed side facing up, fit the paper back into the cassette 1 without changing its orientation.

When ready, press the printer's **OK** button.

3428

Cause

First side printing is complete when manual duplex printing.

What to Do

Prepare to print the other side.

Keeping the printed side facing up, fit the paper back into the cassette 1 without changing its orientation.

When ready, press the printer's **OK** button.

3429

Cause

First side printing is complete when manual duplex printing.

What to Do

Prepare to print the other side.

Keeping the printed side facing up, rotate the paper 180 degrees so that the front edge of the printed paper faces away from you and fit the paper back into the cassette 1.

When ready, press the printer's **OK** button.

3430

Cause

First side printing is complete when manual duplex printing.

What to Do

Prepare to print the other side.

Keeping the printed side facing up, rotate the paper 180 degrees so that the front edge of the printed paper faces away from you and fit the paper back into the cassette 2.

When ready, press the printer's **OK** button.

3431

Cause

First side printing is complete when manual duplex printing.

What to Do

Prepare to print the other side.

Keeping the printed side facing up, fit the paper back into the cassette 2 without changing its orientation.

When ready, press the printer's **OK** button.

3432

Cause

First side printing is complete when manual duplex printing.

What to Do

Prepare to print the other side.

Keeping the printed side facing up, fit the paper back into the cassette 2 without changing its orientation.

When ready, press the printer's **OK** button.

3433

Cause

First side printing is complete when manual duplex printing.

What to Do

Prepare to print the other side.

Keeping the printed side facing up, rotate the paper 180 degrees so that the front edge of the printed paper faces away from you and fit the paper back into the cassette 2.

When ready, press the printer's **OK** button.

4100

Cause

Specified data cannot be printed.

What to Do

If you are printing CREATIVE PARK PREMIUM contents, check the message shown your computer, make sure genuine Canon ink tanks are installed properly for all colors, and retry the printing.

4103

Cause

Cannot perform printing with current print settings.

What to Do

Press the printer's **Stop** button to cancel printing.

Then change the print settings and retry printing.

4104

Cause

Paper size or media type that cannot be fed from cassette 2 is specified.

What to Do

Press the printer's **Stop** button to cancel printing.

Specify the paper size setting to A4, Letter, or Legal and specify the media type setting to Plain Paper. Then print again.

▶▶ Note

- If you will not change the paper size setting or the media type setting, select the cassette 1 as the paper source. If this is the case, register the cassette 1 paper information properly.

5100

Cause

Printer error has occurred.

What to Do

Cancel printing and turn off the printer.

Check the following:

- Make sure print head holder motion is not impeded by stabilizer, jammed paper, etc.

Remove any impediment.

- Make sure the ink tanks are properly installed.

Press ink tanks until they click into place.

Turn the printer back on.

If this does not solve the problem, contact your nearest Canon service center to request a repair.

▶▶ Important

- When clearing an impediment to print head holder motion, be careful not to touch clear film (A) or white belt (B).

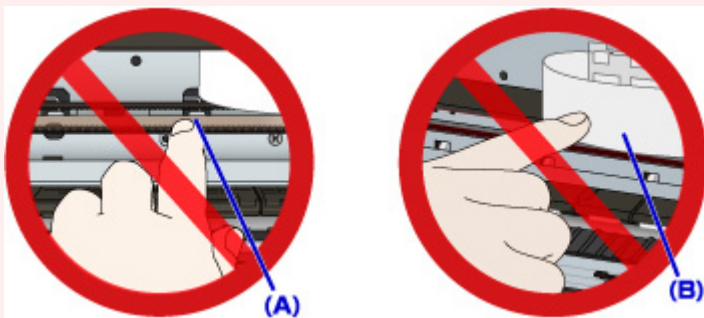

If you soil or scratch these parts by touching them with paper or your hand, it could damage the printer.

5102

Cause

Printer error has occurred.

What to Do

Cancel printing and turn off the printer.

Check the following:

- Make sure print head holder motion is not impeded by stabilizer, jammed paper, etc.

Remove any impediment.

- Make sure the ink tanks are properly installed.

Press ink tanks until they click into place.

Turn the printer back on.

If this does not solve the problem, contact your nearest Canon service center to request a repair.

▶▶ Important

- When clearing an impediment to print head holder motion, be careful not to touch clear film (A) or white belt (B).

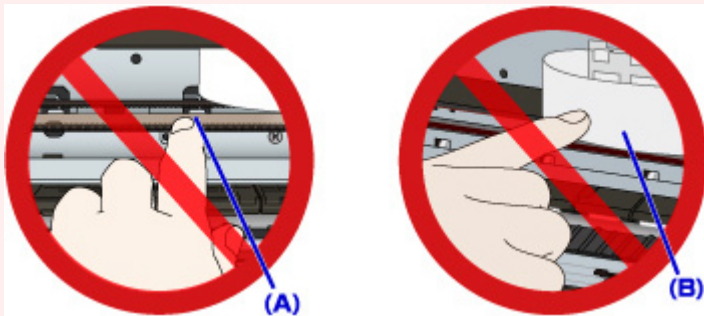

If you soil or scratch these parts by touching them with paper or your hand, it could damage the printer.

5103

Cause

Printer error has occurred.

What to Do

Cancel printing and turn off the printer.

Check the following:

- Make sure print head holder motion is not impeded by stabilizer, jammed paper, etc.

Remove any impediment.

- Make sure the ink tanks are properly installed.

Press ink tanks until they click into place.

Turn the printer back on.

If this does not solve the problem, contact your nearest Canon service center to request a repair.

▶▶ Important

- When clearing an impediment to print head holder motion, be careful not to touch clear film (A) or white belt (B).

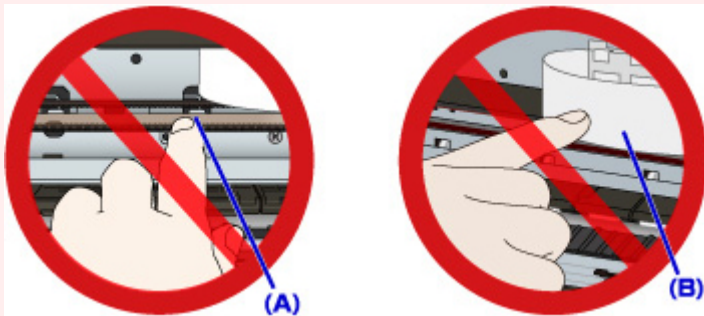

If you soil or scratch these parts by touching them with paper or your hand, it could damage the printer.

5104

Cause

Printer error has occurred.

What to Do

Cancel printing and turn off the printer.

Check the following:

- Make sure print head holder motion is not impeded by stabilizer, jammed paper, etc.

Remove any impediment.

- Make sure the ink tanks are properly installed.

Press ink tanks until they click into place.

Turn the printer back on.

If this does not solve the problem, contact your nearest Canon service center to request a repair.

▶▶ Important

- When clearing an impediment to print head holder motion, be careful not to touch clear film (A) or white belt (B).

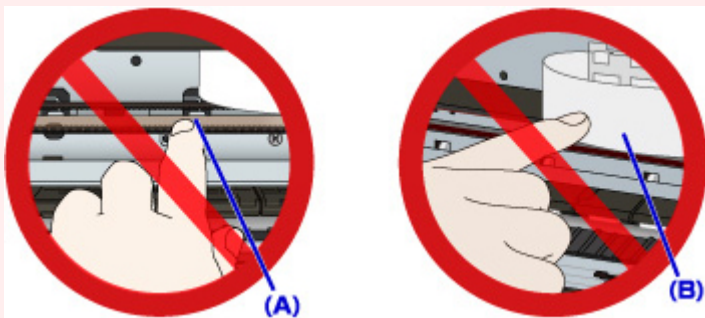

If you soil or scratch these parts by touching them with paper or your hand, it could damage the printer.

5105

Cause

Printer error has occurred.

What to Do

Cancel printing and turn off the printer.

Check the following:

- Make sure print head holder motion is not impeded by stabilizer, jammed paper, etc.

Remove any impediment.

- Make sure the ink tanks are properly installed.

Press ink tanks until they click into place.

Turn the printer back on.

If this does not solve the problem, contact your nearest Canon service center to request a repair.

▶▶ Important

- When clearing an impediment to print head holder motion, be careful not to touch clear film (A) or white belt (B).

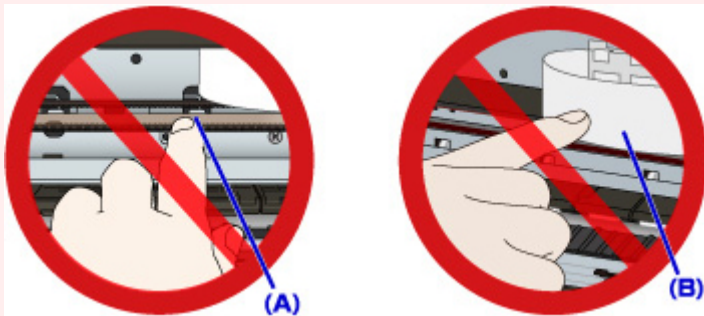

If you soil or scratch these parts by touching them with paper or your hand, it could damage the printer.

5200

Cause

Printer error has occurred.

What to Do

Turn off the printer and unplug it.

Plug in the printer again and turn it back on.

If this does not solve the problem, contact your nearest Canon service center to request a repair.

5203

Cause

Printer error has occurred.

What to Do

Turn off the printer and unplug it.

Plug in the printer again and turn it back on.

If this does not solve the problem, contact your nearest Canon service center to request a repair.

5204

Cause

Printer error has occurred.

What to Do

Turn off the printer and unplug it.

Plug in the printer again and turn it back on.

If this does not solve the problem, contact your nearest Canon service center to request a repair.

5205

Cause

Printer error has occurred.

What to Do

Turn off the printer and unplug it.

Plug in the printer again and turn it back on.

If this does not solve the problem, contact your nearest Canon service center to request a repair.

5206

Cause

Printer error has occurred.

What to Do

Turn off the printer and unplug it.

Plug in the printer again and turn it back on.

If this does not solve the problem, contact your nearest Canon service center to request a repair.

5207

Cause

Printer error has occurred.

What to Do

Turn off the printer and unplug it.

Plug in the printer again and turn it back on.

If this does not solve the problem, contact your nearest Canon service center to request a repair.

5208

Cause

Printer error has occurred.

What to Do

Turn off the printer and unplug it.

Plug in the printer again and turn it back on.

If this does not solve the problem, contact your nearest Canon service center to request a repair.

5209

Cause

Printer error has occurred.

What to Do

Turn off the printer and unplug it.

Plug in the printer again and turn it back on.

If this does not solve the problem, contact your nearest Canon service center to request a repair.

5400

Cause

Printer error has occurred.

What to Do

Turn off the printer and unplug it.

Plug in the printer again and turn it back on.

If this does not solve the problem, contact your nearest Canon service center to request a repair.

5500

Cause

Ink tank has not been properly recognized.

What to Do

Contact the service center.

5501

Cause

Ink tank has not been properly recognized.

What to Do

Contact the service center.

5B00

Cause

Printer error has occurred.

What to Do

Contact your nearest Canon service center to request a repair.

5B01

Cause

Printer error has occurred.

What to Do

Contact your nearest Canon service center to request a repair.

5C01

Cause

Printer error has occurred.

What to Do

Turn off the printer and unplug it.

Plug in the printer again and turn it back on.

If this does not solve the problem, contact your nearest Canon service center to request a repair.

6000

Cause

Printer error has occurred.

What to Do

Turn off the printer and unplug it.

Plug in the printer again and turn it back on.

If this does not solve the problem, contact your nearest Canon service center to request a repair.

6500

Cause

Printer error has occurred.

What to Do

Turn off the printer and unplug it.

Plug in the printer again and turn it back on.

If this does not solve the problem, contact your nearest Canon service center to request a repair.

6502

Cause

Printer error has occurred.

What to Do

Turn off the printer and unplug it.

Plug in the printer again and turn it back on.

If this does not solve the problem, contact your nearest Canon service center to request a repair.

6800

Cause

Printer error has occurred.

What to Do

Turn off the printer and unplug it.

Plug in the printer again and turn it back on.

If this does not solve the problem, contact your nearest Canon service center to request a repair.

6801

Cause

Printer error has occurred.

What to Do

Turn off the printer and unplug it.

Plug in the printer again and turn it back on.

If this does not solve the problem, contact your nearest Canon service center to request a repair.

6900

Cause

Printer error has occurred.

What to Do

Turn off the printer and unplug it.

Plug in the printer again and turn it back on.

If this does not solve the problem, contact your nearest Canon service center to request a repair.

6901

Cause

Printer error has occurred.

What to Do

Turn off the printer and unplug it.

Plug in the printer again and turn it back on.

If this does not solve the problem, contact your nearest Canon service center to request a repair.

6902

Cause

Printer error has occurred.

What to Do

Turn off the printer and unplug it.

Plug in the printer again and turn it back on.

If this does not solve the problem, contact your nearest Canon service center to request a repair.

6910

Cause

Printer error has occurred.

What to Do

Turn off the printer and unplug it.

Plug in the printer again and turn it back on.

If this does not solve the problem, contact your nearest Canon service center to request a repair.

6911

Cause

Printer error has occurred.

What to Do

Turn off the printer and unplug it.

Plug in the printer again and turn it back on.

If this does not solve the problem, contact your nearest Canon service center to request a repair.

6920

Cause

Printer error has occurred.

What to Do

Turn off the printer and unplug it.

Plug in the printer again and turn it back on.

If this does not solve the problem, contact your nearest Canon service center to request a repair.

6921

Cause

Printer error has occurred.

What to Do

Turn off the printer and unplug it.

Plug in the printer again and turn it back on.

If this does not solve the problem, contact your nearest Canon service center to request a repair.

6930

Cause

Printer error has occurred.

What to Do

Turn off the printer and unplug it.

Plug in the printer again and turn it back on.

If this does not solve the problem, contact your nearest Canon service center to request a repair.

6931

Cause

Printer error has occurred.

What to Do

Turn off the printer and unplug it.

Plug in the printer again and turn it back on.

If this does not solve the problem, contact your nearest Canon service center to request a repair.

6932

Cause

Printer error has occurred.

What to Do

Turn off the printer and unplug it.

Plug in the printer again and turn it back on.

If this does not solve the problem, contact your nearest Canon service center to request a repair.

6933

Cause

Printer error has occurred.

What to Do

Turn off the printer and unplug it.

Plug in the printer again and turn it back on.

If this does not solve the problem, contact your nearest Canon service center to request a repair.

6940

Cause

Printer error has occurred.

What to Do

Turn off the printer and unplug it.

Plug in the printer again and turn it back on.

If this does not solve the problem, contact your nearest Canon service center to request a repair.

6941

Cause

Printer error has occurred.

What to Do

Turn off the printer and unplug it.

Plug in the printer again and turn it back on.

If this does not solve the problem, contact your nearest Canon service center to request a repair.

6942

Cause

Printer error has occurred.

What to Do

Turn off the printer and unplug it.

Plug in the printer again and turn it back on.

If this does not solve the problem, contact your nearest Canon service center to request a repair.

6943

Cause

Printer error has occurred.

What to Do

Turn off the printer and unplug it.

Plug in the printer again and turn it back on.

If this does not solve the problem, contact your nearest Canon service center to request a repair.

6944

Cause

Printer error has occurred.

What to Do

Turn off the printer and unplug it.

Plug in the printer again and turn it back on.

If this does not solve the problem, contact your nearest Canon service center to request a repair.

6945

Cause

Printer error has occurred.

What to Do

Turn off the printer and unplug it.

Plug in the printer again and turn it back on.

If this does not solve the problem, contact your nearest Canon service center to request a repair.

6946

Cause

Printer error has occurred.

What to Do

Turn off the printer and unplug it.

Plug in the printer again and turn it back on.

If this does not solve the problem, contact your nearest Canon service center to request a repair.

7100

Cause

Printer error has occurred.

What to Do

Turn off the printer and unplug it.

Plug in the printer again and turn it back on.

If this does not solve the problem, contact your nearest Canon service center to request a repair.

7200

Cause

Printer error has occurred.

What to Do

Turn off the printer and unplug it.

Plug in the printer again and turn it back on.

If this does not solve the problem, contact your nearest Canon service center to request a repair.

7201

Cause

Printer error has occurred.

What to Do

Turn off the printer and unplug it.

Plug in the printer again and turn it back on.

If this does not solve the problem, contact your nearest Canon service center to request a repair.

7202

Cause

Printer error has occurred.

What to Do

Turn off the printer and unplug it.

Plug in the printer again and turn it back on.

If this does not solve the problem, contact your nearest Canon service center to request a repair.

7203

Cause

Printer error has occurred.

What to Do

Turn off the printer and unplug it.

Plug in the printer again and turn it back on.

If this does not solve the problem, contact your nearest Canon service center to request a repair.

7204

Cause

Printer error has occurred.

What to Do

Turn off the printer and unplug it.

Plug in the printer again and turn it back on.

If this does not solve the problem, contact your nearest Canon service center to request a repair.

7205

Cause

Printer error has occurred.

What to Do

Turn off the printer and unplug it.

Plug in the printer again and turn it back on.

If this does not solve the problem, contact your nearest Canon service center to request a repair.

B202

Cause

An error requiring a repair has occurred.

What to Do

Turn off the printer and unplug it.

Contact your nearest Canon service center to request a repair.

B203

Cause

An error requiring a repair has occurred.

What to Do

Turn off the printer and unplug it.

Contact your nearest Canon service center to request a repair.

B204

Cause

An error requiring a repair has occurred.

What to Do

Turn off the printer and unplug it.

Contact your nearest Canon service center to request a repair.

B205

Cause

An error requiring a repair has occurred.

What to Do

Turn off the printer and unplug it.

Contact your nearest Canon service center to request a repair.

B502

Cause

Printer error has occurred.

What to Do

Turn off the printer and unplug it.

Plug in the printer again and turn it back on.

If this does not solve the problem, contact your nearest Canon service center to request a repair.

B503

Cause

Printer error has occurred.

What to Do

Turn off the printer and unplug it.

Plug in the printer again and turn it back on.

If this does not solve the problem, contact your nearest Canon service center to request a repair.

B504

Cause

Printer error has occurred.

What to Do

Turn off the printer and unplug it.

Plug in the printer again and turn it back on.

If this does not solve the problem, contact your nearest Canon service center to request a repair.

C000

Cause

Printer error has occurred.

What to Do

Cancel printing and turn off the printer.

Check the following:

- Make sure print head holder motion is not impeded by stabilizer, jammed paper, etc.

Remove any impediment.

- Make sure the ink tanks are properly installed.

Press ink tanks until they click into place.

Turn the printer back on.

If this does not solve the problem, contact your nearest Canon service center to request a repair.

▶▶ Important

- When clearing an impediment to print head holder motion, be careful not to touch clear film (A) or white belt (B).

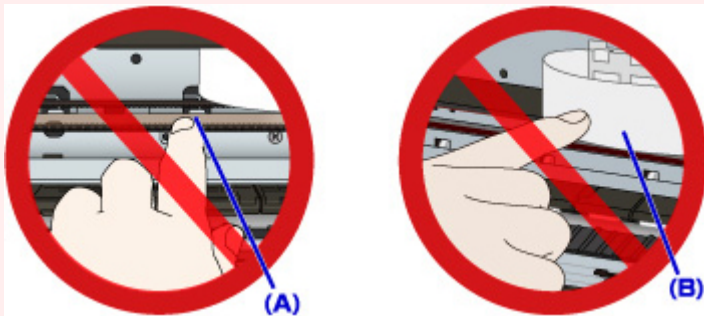

If you soil or scratch these parts by touching them with paper or your hand, it could damage the printer.