



# HP ProBook 440 G3 Notebook PC

## Maintenance and Service Guide

© Copyright 2015 HP Development Company, L.P.

AMD is a trademark of Advanced Micro Devices, Inc. Bluetooth is a trademark owned by its proprietor and used by HP Inc. under license. Intel, Celeron, and Pentium are trademarks of Intel Corporation in the U.S. and other countries. Microsoft and Windows are trademarks of the Microsoft group of companies.

The information contained herein is subject to change without notice. The only warranties for HP products and services are set forth in the express warranty statements accompanying such products and services. Nothing herein should be construed as constituting an additional warranty. HP shall not be liable for technical or editorial errors or omissions contained herein.

First Edition: September 2015

Document Part Number: 824566-001

### **Product notice**

This user guide describes features that are common to most models. Some features may not be available on your computer.

Not all features are available in all editions of Windows. This computer may require upgraded and/or separately purchased hardware, drivers and/or software to take full advantage of Windows functionality. Go to <http://www.microsoft.com> for details.

### **Software terms**

By installing, copying, downloading, or otherwise using any software product preinstalled on this computer, you agree to be bound by the terms of the HP End User License Agreement (EULA). If you do not accept these license terms, your sole remedy is to return the entire unused product (hardware and software) within 14 days for a full refund subject to the refund policy of your seller.

For any further information or to request a full refund of the price of the computer, please contact your seller.

This computer may require upgraded and/ or separately purchased hardware and/or a DVD drive to install the Windows 7 software and take full advantage of Windows 7 functionality. See <http://windows.microsoft.com/en-us/windows7/get-know-windows-7> for details.

## Important Notice about Customer Self-Repair Parts

---

 **CAUTION:** Your computer includes Customer Self-Repair parts and parts that should only be accessed by an authorized service provider. See Chapter 5, "Removal and replacement procedures for Customer Self-Repair parts," for details. Accessing parts described in Chapter 6, "Removal and replacement procedures for Authorized Service Provider only parts," can damage the computer or void your warranty.

---



## Safety warning notice

---

 **WARNING!** To reduce the possibility of heat-related injuries or of overheating the computer, do not place the computer directly on your lap or obstruct the computer air vents. Use the computer only on a hard, flat surface. Do not allow another hard surface, such as an adjoining optional printer, or a soft surface, such as pillows or rugs or clothing, to block airflow. Also, do not allow the AC adapter to contact the skin or a soft surface, such as pillows or rugs or clothing, during operation. The computer and the AC adapter comply with the user-accessible surface temperature limits defined by the International Standard for Safety of Information Technology Equipment (IEC 60950-1).

---



---

# Table of contents

<b>1 Product description</b>	<b>1</b>
<b>2 Components</b>	<b>6</b>
Right	6
Left	7
Display	9
Top	10
TouchPad	10
Lights	11
Buttons, speakers, and fingerprint reader	12
Keys	14
Bottom	15
Labels	17
<b>3 Illustrated parts catalog</b>	<b>18</b>
Computer major components	18
Display components	22
Cable Kit	23
Plastics Kit	23
Mass storage devices	24
Miscellaneous parts	25
<b>4 Removal and replacement procedures preliminary requirements</b>	<b>27</b>
Tools required	27
Service considerations	27
Plastic parts	27
Cables and connectors	28
Drive handling	28
Grounding guidelines	29
Electrostatic discharge damage	29
Packaging and transporting guidelines	30
Workstation guidelines	30
Equipment guidelines	31
<b>5 Removal and replacement procedures for Customer Self-Repair parts</b>	<b>32</b>
Component replacement procedures	32

Battery .....	33
Service door .....	34
Hard drive .....	35
Memory modules .....	37
WLAN/Bluetooth combo card .....	39
M.2 solid-state drive .....	41
Keyboard .....	42

## **6 Removal and replacement procedures for Authorized Service Provider parts ..... 47**

Component replacement procedures .....	47
Top cover .....	47
Fingerprint reader assembly .....	51
Power button board .....	53
Function board .....	54
USB/audio/card reader board .....	55
Fan .....	57
Battery connector cable .....	59
System board .....	60
RTC battery .....	63
Speaker assembly .....	64
Heat sink assembly .....	66
Display assembly .....	69
Power connector and cable .....	74

## **7 Computer Setup (BIOS) and MultiBoot in Windows 7 ..... 75**

Using Computer Setup .....	75
Starting Computer Setup .....	75
Navigating and selecting in Computer Setup .....	75
Restoring factory settings in Computer Setup .....	76
Updating the BIOS .....	76
Determining the BIOS version .....	76
Downloading a BIOS update .....	77
Using MultiBoot .....	77
About the boot device order .....	77
Choosing MultiBoot preferences .....	78
Setting a new boot order in Computer Setup .....	78
Dynamically choosing a boot device using the f9 prompt .....	78
Setting a MultiBoot Express prompt .....	79
Entering MultiBoot Express preferences .....	79
Using HP Sure Start (select models only) .....	79



<b>8 Computer Setup (BIOS) and MultiBoot in Windows 8.1 .....</b>	<b>80</b>
Using Computer Setup .....	80
Starting Computer Setup .....	80
Navigating and selecting in Computer Setup .....	80
Restoring factory settings in Computer Setup .....	81
Updating the BIOS .....	81
Determining the BIOS version .....	81
Downloading a BIOS update .....	82
Using MultiBoot .....	83
About the boot device order .....	83
Choosing MultiBoot preferences .....	83
Setting a new boot order in Computer Setup .....	83
Dynamically choosing a boot device using the f9 prompt .....	84
Setting a MultiBoot Express prompt .....	84
Entering MultiBoot Express preferences .....	84
Using HP Sure Start (select models only) .....	85
<b>9 Computer Setup (BIOS), TPM, and HP Sure Start in Windows 10 .....</b>	<b>86</b>
Using Computer Setup .....	86
Starting Computer Setup .....	86
Navigating and selecting in Computer Setup .....	86
Restoring factory settings in Computer Setup .....	87
Updating the BIOS .....	88
Determining the BIOS version .....	88
Downloading a BIOS update .....	88
Changing the boot order using the f9 prompt .....	89
TPM BIOS settings (select products only) .....	89
Using HP Sure Start (select products only) .....	90
<b>10 Computer Setup (BIOS) in Ubuntu Linux .....</b>	<b>91</b>
Starting Computer Setup .....	91
Using Computer Setup .....	91
Navigating and selecting in Computer Setup .....	91
Restoring factory settings in Computer Setup .....	92
Updating the BIOS .....	92
Determining the BIOS version .....	92
Downloading a BIOS update .....	93
<b>11 HP PC Hardware Diagnostics (UEFI) .....</b>	<b>94</b>
Downloading HP PC Hardware Diagnostics (UEFI) to a USB device .....	94

<b>12 Backup and recovery in Windows 7 .....</b>	<b>96</b>
Creating recovery media and backups .....	96
Guidelines .....	96
Creating recovery media with HP Recovery Disc Creator .....	96
Creating recovery media .....	97
Backing up your information .....	97
Performing a system recovery .....	98
Using the Windows recovery tools .....	98
Using f11 recovery tools (select models only) .....	99
Using Windows 7 operating system media .....	99
 <b>13 Backup and recovery in Windows 8.1 .....</b>	 <b>101</b>
Backing up your information .....	101
Performing a system recovery .....	101
Using the Windows recovery tools .....	101
Using f11 recovery tools .....	102
Using Windows operating system media (purchased separately) .....	103
Using Windows Refresh or Windows Reset .....	103
Using HP Software Setup .....	103
 <b>14 Backup and recovery in Windows 10 .....</b>	 <b>104</b>
Creating recovery media and backups .....	104
Creating HP Recovery media (select products only) .....	104
Using Windows tools .....	105
Restore and recovery .....	106
Recovering using HP Recovery Manager .....	106
What you need to know before you get started .....	106
Using the HP Recovery partition (select products only) .....	107
Using HP Recovery media to recover .....	107
Changing the computer boot order .....	108
Removing the HP Recovery partition (select products only) .....	109
 <b>15 Backup and Recovery in Ubuntu Linux .....</b>	 <b>110</b>
Creating backups .....	110
Backing up your information .....	110
Performing a system recovery .....	111
USB Recovery option (select models only) .....	111
Remove everything and reinstall Ubuntu .....	112

<b>16 Specifications .....</b>	<b>114</b>
Computer specifications .....	114
35.6-cm (14.0-in) display specifications .....	115
Hard drive specifications .....	116
Solid-state drive specifications .....	117
<b>17 Statement of memory volatility .....</b>	<b>118</b>
Nonvolatile memory usage .....	122
Questions and answers .....	124
Using HP Sure Start (select models only) .....	125
<b>18 Power cord set requirements .....</b>	<b>126</b>
Requirements for all countries and regions .....	126
Requirements for specific countries and regions .....	126
<b>19 Recycling .....</b>	<b>128</b>
<b>Index .....</b>	<b>129</b>



# 1 Product description

Category	Description
<b>Product Name</b>	<b>HP ProBook 440 G3 Notebook PC</b>
<b>Processors</b>	<b>Intel® Core™ i7 processor, Dual Core, 6th generation</b> (4-MB L3 cache, 15 W) 6500U, 2.6 GHz/3.1 GHz Single Core Turbo <b>Intel® Core i5 processors, Dual Core, 6th generation</b> (3-MB L3 cache, 15 W) 6300U, 2.4-GHz/3.0-GHz Single Core Turbo processor 6200U, 2.3-GHz/2.8-GHz Single Core Turbo processor <b>Intel Core i3 processors, Dual Core, 6th generation</b> (3-MB L3 cache, 15 W) 6100U, 2.3-GHz processor/Intel HD Graphics 520 <b>Intel Pentium processor</b> (2-MB L3 cache, 15 W) 4405U, 2.1-GHz processor/Intel HD Graphics 510 <b>Intel Celeron processor</b> (2-MB L3 cache, 15 W) 3855U, 1.6-GHz processor/Intel HD Graphics 510
<b>Chipset</b>	Intel Skylake; Integrated with processor
<b>Graphics</b>	<b>Integrated UMA Graphics GT1 and GT2</b> See processor category. <b>Switchable discrete:</b> AMD Radeon R7 M340 with 2 GB or 1 GB dedicated video memory Supports HD decode, DX12, HDMI Supports PX7.0
<b>Panel</b>	<b>35.6-cm (14.0-inch), LED backlight, 16:9 aspect ratio, HD eDP – flat</b> HD, anti-glare, 1366x768, 220 nits, 3.6 mm, 1 or 2 WLAN antennas HD, anti-glare, 1366x768, 220 nits, 3.6 mm, 1 or 2 WLAN antennas, camera HD, 1366x768, 3.6 mm, 1 or 2 WLAN antennas, camera, touch panel <b>FHD eDP – slim</b> FHD, anti-glare, 1600x900, 220 nits, 3.0 mm, 1 or 2 WLAN antennas FHD, anti-glare, 1600x900, 220 nits, 3.0 mm, 1 or 2 WLAN antennas, camera
<b>Memory</b>	Two customer-accessible memory module slots supporting up to 16 GB of RAM Supports dual-channel memory PC3L-12800, 1600-MHz, DDR3L SODIMMs Supports the following configurations: <ul style="list-style-type: none"><li>• 16384 MB (8192 × 2; dual channel)</li><li>• 12288 MB (8192 + 4096; dual channel)</li></ul>

Category	Description
	<ul style="list-style-type: none"> <li>• 8192 MB (8192 × 1)</li> <li>• 8192 MB (4096 × 2; dual channel)</li> <li>• 6144 MB (4096 + 2048; dual channel)</li> <li>• 4096 MB (4096 × 1)</li> <li>• 2048 MB (2048 × 1)</li> </ul>
	<p>Supports the following configurations (Brazil):</p> <ul style="list-style-type: none"> <li>• 16384 MB (8192 × 2; dual channel)</li> <li>• 8192 MB (8192 × 1)</li> <li>• 8192 MB (4096 × 2; dual channel)</li> <li>• 4096 MB (4096 × 1)</li> <li>• 2048 MB (2048 × 1)</li> </ul>
<b>Mini card</b>	<p><b>M.2 2280 SSD (NGFF), SATA-3</b></p> <p>Supports the following drives:</p> <ul style="list-style-type: none"> <li>• 256 GB TLC</li> <li>• 128 GB TLC</li> </ul> <p>Set as primary storage if selected.</p>
<b>Primary storage</b>	<p>Supports 7-mm, 2.5-in SATA hard drives with HP 3D DriveGuard:</p> <ul style="list-style-type: none"> <li>• 1-TB, 5400-rpm</li> <li>• 500-GB, 7200-rpm</li> <li>• 500-GB, 5400-rpm</li> <li>• 500-GB, 5400-rpm, hybrid (8-GB SSD) MLC</li> </ul>
<b>Optical drive</b>	Supports external USB drive CD/DVD R/RW
<b>Audio/Visual</b>	<p>Integrated camera (720p HD)</p> <p>Supports “no camera” option</p> <p>Stereo speakers (2)</p> <p>Integrated dual-array microphone (webcam models only)</p> <p>Integrated mono microphone (non-webcam models only)</p> <p>Headphone/microphone combo jack</p> <p>HD audio with DTS Sound</p> <p>Conexant CX7501</p>
<b>Ethernet</b>	<p>Realtek RTL8111HSH 10/100/1000</p> <p>S3/S4/S5 wake on LAN (AC mode and battery mode)</p> <p>Ethernet cable not included</p>
<b>Wireless</b>	<p><b>Integrated WLAN options by way of wireless module:</b></p> <p>WLAN antennas built into display assembly</p> <p>Supports “no WLAN/Bluetooth” option</p>

Category	Description
	<ul style="list-style-type: none"> <li>• Realtek RTL8188EE 802.11b/g/n 1x1 Wi-Fi Adapter</li> <li>• Realtek RTL8723BE 802.11b/g/n 1x1 Wi-Fi + BT4.0 Combo Adapter</li> <li>• Realtek RTL8723BE bgn 1x1 + BT 4 LE PCIe+USB NGFF 2230 M.2</li> <li>• Broadcom 943228 abgn 2x2 + BT 4 LE PCIe+USB NGFF 2230</li> <li>• 7260NGW Intel Dual Band Wireless-AC 7260 802.11ac, Dual Band, 2x2 Wi-Fi + Bluetooth 4.0</li> <li>• Intel Dual Band Wireless-AC 3165 802.11ac, Dual Band, 1x1 Wi-Fi + Bluetooth 4.0</li> </ul>
	<p><b>Wireless Personal Area Network (PAN) Bluetooth</b></p> <p>Bluetooth 4.0 supported on all combo cards except for Snowfield Peak Non-vPro</p> <p>Bluetooth 4.1 supported via Snowfield Peak Non-vPro only</p>
<b>External media card</b>	<p>Digital Media Reader Slot</p> <p>Supports SD, SDHC, SDXC</p>
<b>Ports</b>	<p>Headphone/Microphone Combo Jack</p> <p>RJ-45 (Ethernet, includes link and activity lights)</p> <p>USB 3.0 (2)</p> <p>USB 2.0 (1)</p> <p>USB 2.0 powered port</p> <p>VGA (Dsub 15-pin) supporting 2048 × 1536 external resolution at 60-GHz (hot plug/unplug with auto-detect)</p> <p>HDMI 1.4</p> <p>Multi-pin AC port</p>
<b>Keyboard/pointing devices</b>	<p><b>Keyboards</b></p> <p>HP Advanced Keyboard</p> <p>Backlit full-sized keyboard</p> <p>Full-sized, chiclet keyboard</p> <p>Spill-resistant keyboard</p> <p><b>Touchpad</b></p> <p>Touchpad gestures enabled by default: on/off button on board, taps enabled by default, 2-finger scrolling and zoom enabled by default, OSD (enable/disable), Win8 2 finger tap=right click, Win8 edge swipes</p> <p>Touchpad gestures disabled by default: 3 finger flick, 2 finger rotate, momentum motion, 1 finger vertical scroll</p>
<b>Power requirements</b>	<p><b>AC adapters</b></p> <p>65-W Smart AC adapter, 4.5 mm</p> <p>65-W Smart AC adapter, 4.5 mm – EM (only available in Asia, the People's Republic of China, and India)</p> <p>45-W Smart AC adapter, 4.5 mm</p> <p>45-W Smart AC adapter, 4.5 mm, 2-prong (Japan only)</p> <p><b>Power cords</b></p> <p>Power cord: 3-wire plug - 1.8 m or 1.0 m</p>

<b>Category</b>	<b>Description</b>
	Power cord: 2-wire plug - 1.0 m
	<b>Batteries</b>
	4-cell, 44-Wh, 3.0 Ah, Li-ion battery
	4-cell, 40-Wh, 3.0 Ah, Li-ion battery (long life)
<b>Security</b>	Integrated fingerprint reader
	No fingerprint reader option
	Security lock
	TPM SLB9670 (FW ver. 1.2) (Infineon; soldered down)
	TPM support
<b>Operating system</b>	<b>Preinstalled:</b>
	Windows 7 Professional 64
	Windows 7 Professional 64 – CPPP
	Windows 7 Professional 64 – StF MSNA
	Windows 7 Professional 32
	Windows 8.1 CH 64 – CPPP
	Windows 8.1 (EM) 64
	Windows 8.1 (EM) 64 – High End
	Windows 8.1 (ML) 64
	Windows 8.1 (ML) 64 – High End
	Windows 8.1 Professional 64
	Windows 8.1 Core for Higher Education ML 64
	Windows 8.1 Professional StF MSNA
	Windows 8.1 Professional StF MSNA EM
	Windows 10 Home 64
	Windows 10 Home 64 Single Language
	Windows 10 Home 64 Chinese Market
	Windows 10 Home 64 Chinese Market – CPPP
	Windows 10 Home 64 StF MSNA for Higher Education
	Windows 10 Home 64 High-end
	Windows 10 Home 64 High-end Single Language
	Windows 10 Home 64 High-end Chinese Market
	Windows 10 Professional 64
	Windows 10 Professional StF MSNA
	Windows 10 Professional StF MSNA EM
	Windows 10 Professional 64 Downgrade Windows 7 32
	Windows 10 Professional 64 Downgrade Windows 7 32 StF MSNA
	Windows 10 Professional 64 Downgrade Windows 7 64





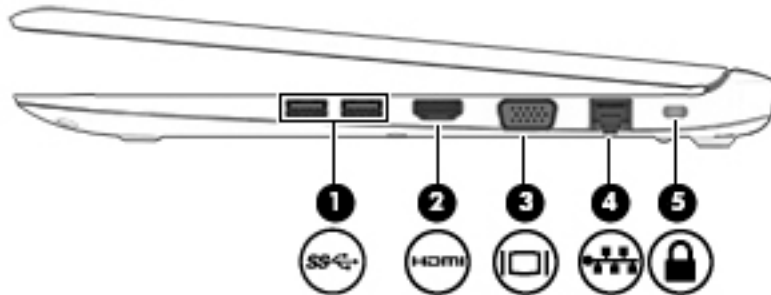

Category	Description
	Windows 10 Professional 64 Downgrade Windows 7 64 StF MSNA
	Windows 10 Professional 64 Downgrade Windows 7 64 StF MSNA EM
	Ubuntu Linux 14.04
	Ubuntu Kylin Linux 14.04
	FreeDOS 2.0
	<b>Restore Media (DRDVD/SRDVD):</b>
	DRDVD Windows 10
	DRDVD Windows 8.1
	DRDVD Windows 7
	SRDVD Ubuntu Linux
	<b>Restore Media (OSDVD):</b>
	Windows 7 Professional 32
	Windows 7 Professional 64
	Windows 8.1 (Update) Professional 64
	Windows 8.1 (Update) Professional for Education 64
	Windows 8.1 (Update) 64
	Windows 8.1 (Update) Country Specific 64
	Windows 8.1 (Update) Emerging Market 64
	Windows 10 Professional 64
	<b>Web-only support:</b>
	Windows 7 Professional 32
	Windows 7 Enterprise 64
	Windows 7 Enterprise 32
	Windows 8.1 Enterprise 64
	Windows 10 Enterprise
	<b>Certified:</b>
	Microsoft WHQL
<b>Serviceability</b>	<b>End-user replaceable parts:</b>
	AC adapter
	Battery (system)
	Hard drive
	Memory module
	Mini-card SSD
	WLAN module
	Keyboard

## 2 Components



### Right



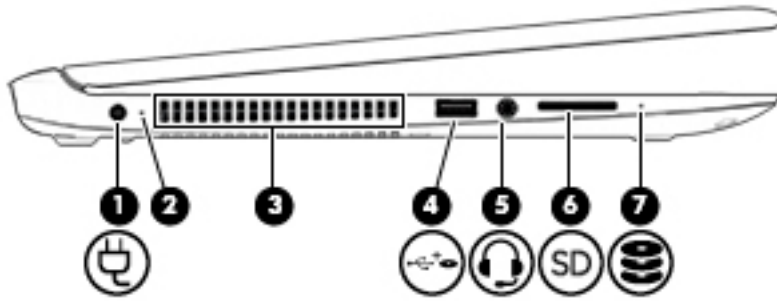

Component	Description
(1)  USB 3.0 ports (2)	Connect an optional USB device, such as a keyboard, mouse, external drive, printer, scanner or USB hub.
(2)  HDMI port	Connects an optional video or audio device, such as a high-definition television, any compatible digital or audio component, or a high-speed High Definition Multimedia Interface (HDMI) device.
(3)  External monitor port	Connects an external VGA monitor or projector.
(4)  RJ-45 (network) jack/status lights	Connects a network cable. <ul style="list-style-type: none"><li>• Green (right): The network is connected.</li><li>• Amber (left): Activity is occurring on the network.</li></ul>
(5)  Security cable slot	Attaches an optional security cable to the computer. <b>NOTE:</b> The security cable is designed to act as a deterrent, but it may not prevent the computer from being mishandled or stolen.

# Left



Component	Description
(1)  Power connector	Connects an AC adapter.
(2) Battery light	<p>When AC power is connected:</p> <ul style="list-style-type: none"> <li>• White: The battery charge is greater than 90 percent.</li> <li>• Amber: The battery charge is from 0 to 90 percent.</li> <li>• Off: The battery is not charging.</li> </ul> <p>When AC power is disconnected (battery not charging):</p> <ul style="list-style-type: none"> <li>• Blinking amber: The battery has reached a low battery level. When the battery has reached a critical battery level, the battery light begins blinking rapidly.</li> <li>• Off: The battery is not charging.</li> </ul>
(3) Vent	<p>Enables airflow to cool internal components.</p> <p><b>NOTE:</b> The computer fan starts up automatically to cool internal components and prevent overheating. It is normal for the internal fan to cycle on and off during routine operation.</p>
(4)  USB 2.0 charging (powered) port	<p>Connects an optional USB device, such as a keyboard, mouse, external drive, printer, scanner or USB hub. Standard USB ports will not charge all USB devices or will charge using a low current. Some USB devices require power and require you to use a powered port.</p> <p><b>NOTE:</b> USB charging ports can also charge select models of cell phones and MP3 players, even when the computer is off.</p>
(5)  Audio-out (headphone)/Audio-in (microphone) combo jack	<p>Connects optional powered stereo speakers, headphones, earbuds, a headset, or a television audio cable. Also connects an optional headset microphone. This jack does not support optional microphone-only devices.</p>

Component	Description
	<p><b>WARNING!</b> To reduce the risk of personal injury, adjust the volume before putting on headphones, earbuds, or a headset. For additional safety information, refer to the <i>Regulatory, Safety, and Environmental Notices</i>.</p> <p>To access this document:</p> <p><b>Windows 7:</b></p> <p>Select <b>Start &gt; All Programs &gt; HP Help and Support &gt; HP Documentation</b>.</p> <p><b>Windows 8.1:</b></p> <p>From the Start screen, type <code>support</code>, and then select the <b>HP Support Assistant</b> app.</p> <p>– or –</p> <p>From the Windows desktop, click the question mark icon in the notification area, at the far right of the taskbar.</p> <p><b>Windows 10:</b></p> <p>Select <b>Start</b>, select <b>All apps</b>, select <b>HP Help and Support</b>, and then select <b>HP Documentation</b>.</p> <p><b>NOTE:</b> When a device is connected to the jack, the computer speakers are disabled.</p>
<p>(6)  Memory card reader</p>	<p>Reads optional memory cards that store, manage, share, or access information.</p>
<p>(7)  Hard drive light</p>	<ul style="list-style-type: none"> <li>• Blinking white: The hard drive is being accessed.</li> <li>• Amber: HP 3D DriveGuard has temporarily parked the hard drive.</li> </ul>

# Display

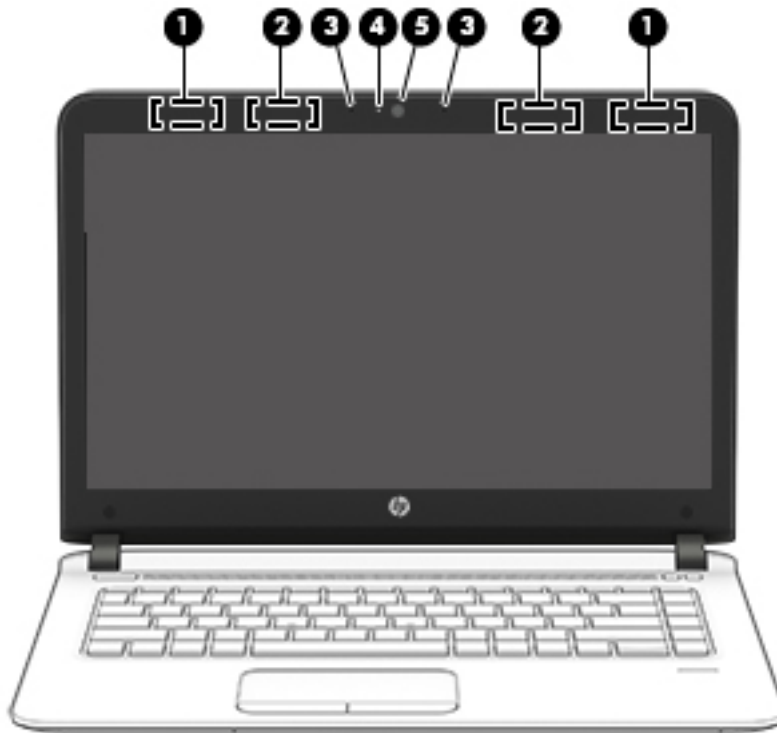

Component	Description
(1) WLAN antennas (2)* (select products only)	Send and receive wireless signals to communicate with wireless local area networks (WLANs).
(2) WWAN antennas (2)* (select products only)	Send and receive wireless signals to communicate with wireless wide area networks (WWANs).
(3) Internal microphones (2)	Record sound.
(4) Webcam light (select products only)	On: The webcam is in use.
(5) Webcam (select products only)	Records video and captures photographs. Some models allow you to video conference and chat online using streaming video.  To use the webcam:  <b>Windows 7:</b> Select <b>Start &gt; All Programs &gt; Communication and Chat &gt; HP Webcam</b> .  <b>Windows 8.1:</b> Access HP Support Assistant from the Start screen by selecting the <b>HP Support Assistant</b> app.  <b>Windows 10:</b> Type <code>camera</code> in the taskbar search box, and then select <b>Camera</b> .

\*The antennas are not visible from the outside of the computer. For optimal transmission, keep the areas immediately around the antennas free from obstructions.

For wireless regulatory notices, see the section of the *Regulatory, Safety, and Environmental Notices* that applies to your country or region. To access this guide:

**Windows 7:** Select **Start > All Programs > HP Help and Support > HP Documentation**.

**Windows 8.1:** From the Start screen, type `support`, and then select the **HP Support Assistant** app.

**Windows 10:** Select **Start**, select **All apps**, select **HP Help and Support**, and then select **HP Documentation**.

# Top



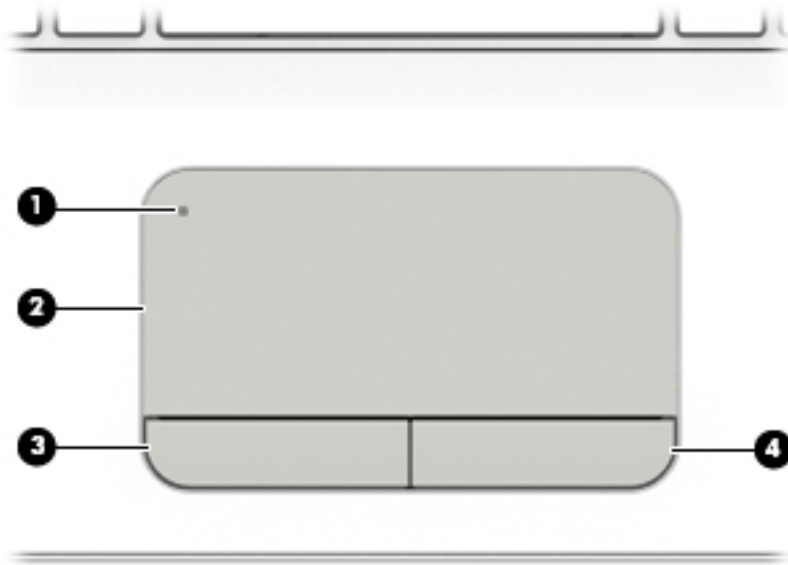

## TouchPad

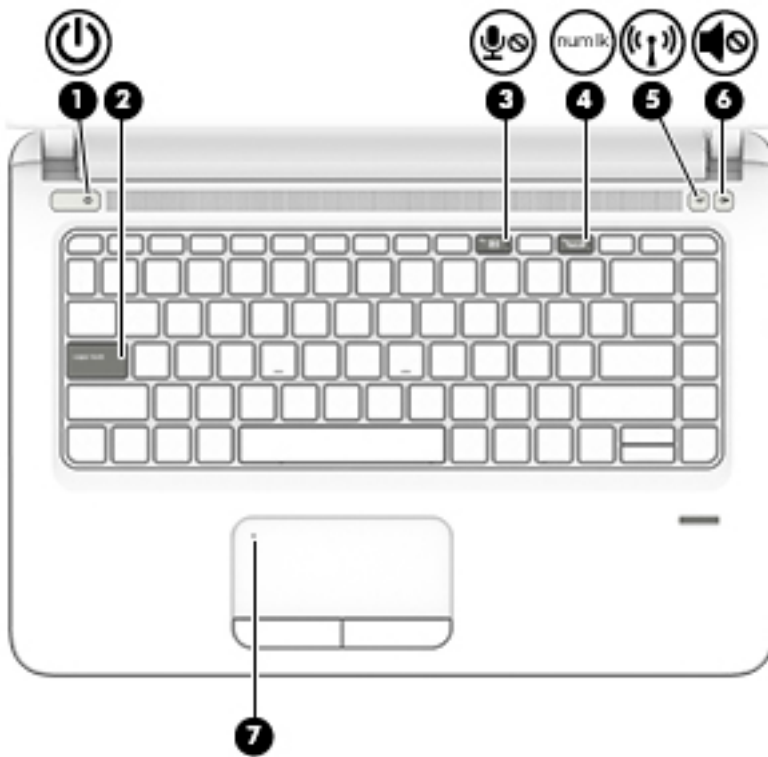

Component	Description	
(1)	TouchPad on/off button	Turns the TouchPad on and off.
(2)	TouchPad zone	Reads your finger gestures to move the pointer or activate items on the screen.
(3)	Left TouchPad button	Functions like the left button on an external mouse.
(4)	Right TouchPad button	Functions like the right button on an external mouse.

## Lights



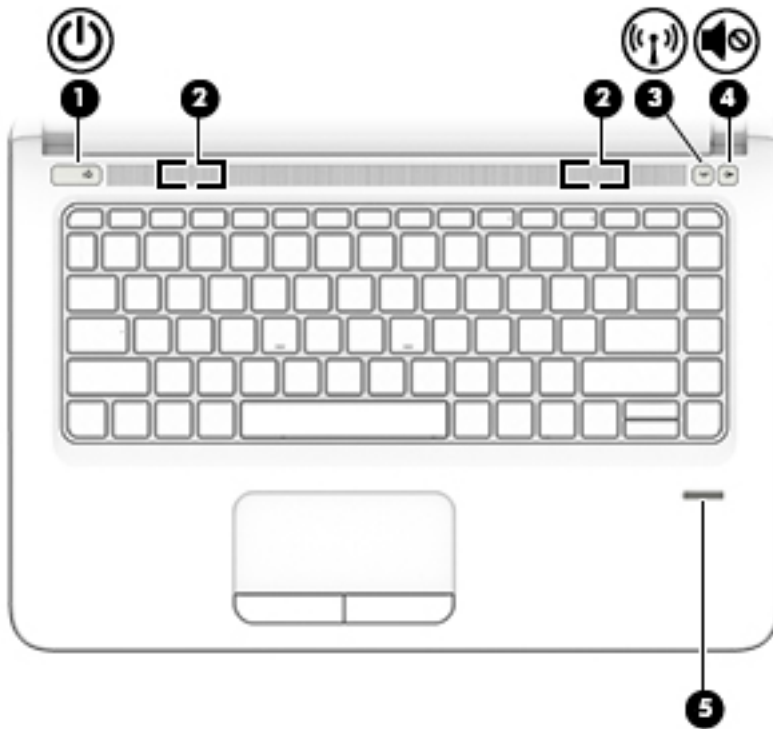

Component	Description
(1)  Power light	<ul style="list-style-type: none"> <li>On: The computer is on.</li> <li>Blinking: The computer is in the Sleep state, a power-saving state. The computer shuts off power to the display and other unneeded components.</li> <li>Off: The computer is off or in Hibernation. Hibernation is a power-saving state that uses the least amount of power.</li> </ul>
(2) Caps lock light	On: Caps lock is on, which switches the key input to all capital letters.
(3)  Microphone mute light	<ul style="list-style-type: none"> <li>Amber: microphone sound is off.</li> <li>Off: microphone sound is on.</li> </ul>
(4)  Num lock light	On: Num lock is on.
(5)  Wireless light	<p>On: An integrated wireless device, such as a wireless local area network (WLAN) device and/or a Bluetooth® device, is on.</p> <p><b>NOTE:</b> On some models, the wireless light is amber when all wireless devices are off.</p>
(6)  Mute light	<ul style="list-style-type: none"> <li>Amber: Computer sound is off.</li> <li>White: Computer sound is on.</li> </ul>
(7) TouchPad light	<ul style="list-style-type: none"> <li>Amber: The TouchPad is off.</li> <li>Off: The TouchPad is on.</li> </ul>

## Buttons, speakers, and fingerprint reader





Component	Description
<p>(1)  Power button</p>	<ul style="list-style-type: none"><li>• When the computer is off, press the button to turn on the computer.</li><li>• When the computer is on, press the button briefly to initiate Sleep.</li><li>• When the computer is in the Sleep state, press the button briefly to exit Sleep.</li><li>• When the computer is in Hibernation, press the button briefly to exit Hibernation.</li></ul> <p><b>CAUTION:</b> Pressing and holding down the power button results in the loss of unsaved information.</p> <p>If the computer has stopped responding and shutdown procedures are ineffective, press and hold the power button for at least 5 seconds to turn off the computer.</p> <p>To learn more about your power settings, see your power options:</p> <p><b>Windows 7:</b> Select <b>Start &gt; Control Panel &gt; System and Security &gt; Power Options</b>.</p> <p><b>Windows 8.1:</b> From the Start screen, type <code>power</code>, select <b>Power and sleep settings</b>, and then select <b>Power and sleep</b> from the list of applications.</p> <p><b>Windows 10:</b> Type <code>power</code> in the taskbar search box, and then select <b>Power and sleep settings</b>.</p> <p>– or –</p> <p>Right-click the <b>Start</b> button, and then select <b>Power Options</b>.</p>



Component	Description
(2) Speakers (2)	Produce sound.
(3)  Wireless button	Turns the wireless feature on or off but does not establish a wireless connection. A wireless network must be set up before a wireless connection is possible.
(4)  Volume mute button	Mutes and restores speaker sound.
(5) Fingerprint reader (select products only)	Allows a fingerprint logon to Windows, instead of a password logon.

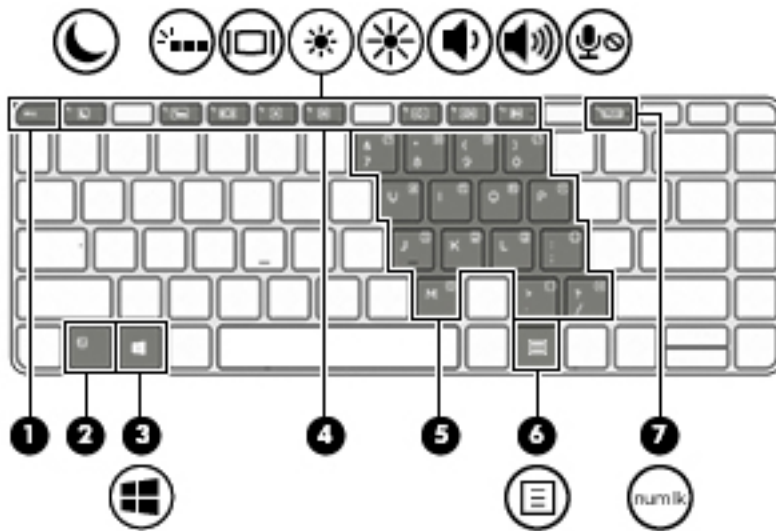

## Keys

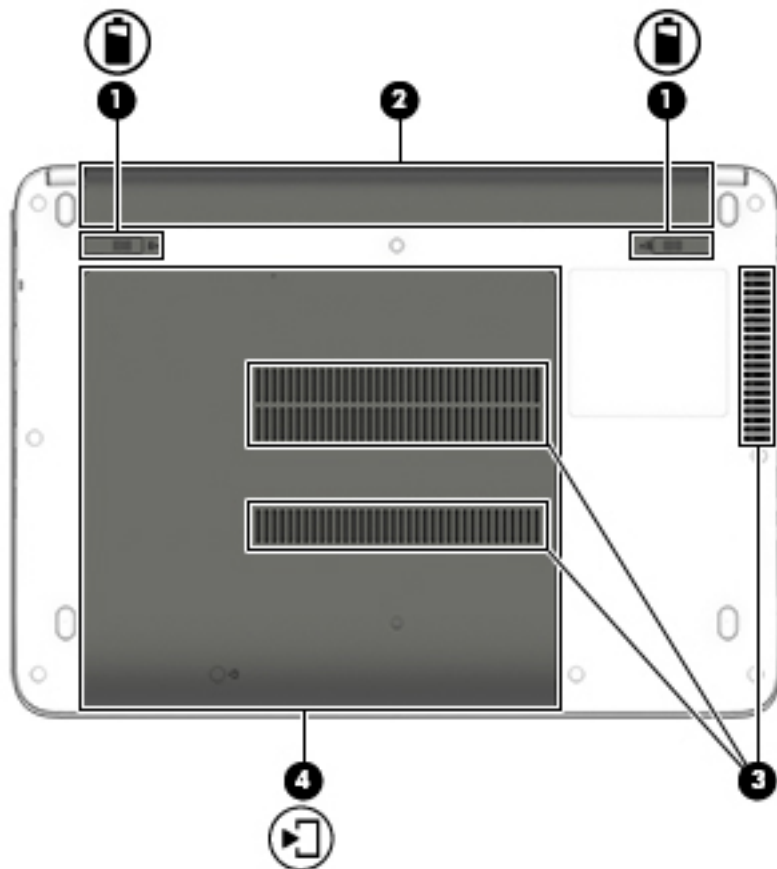

Component	Description
(1) <a href="#">esc</a> key	Displays system information when pressed in combination with the <a href="#">fn</a> key.
(2) <a href="#">fn</a> key	Executes frequently used system functions when pressed in combination with a function key, the <a href="#">num lock</a> key, or the <a href="#">esc</a> key.
(3)  Windows key	<p><b>Windows 7:</b> Displays the Windows Start menu.</p> <p><b>Windows 8.1:</b> Returns you to the Start screen from an open app or the Windows desktop.</p> <p><b>NOTE:</b> Pressing the Windows key again will return you to the previous screen.</p> <p><b>Windows 10:</b> Opens the Windows <b>Start</b> menu.</p> <p><b>NOTE:</b> Pressing the Windows key again will close the <b>Start</b> menu.</p>
(4) Function keys	Execute frequently used system functions when pressed in combination with the <a href="#">fn</a> key.
(5) Embedded numeric keypad	A numeric keypad superimposed over the keyboard alphabet keys that enables you to add, subtract, and perform other numeric tasks. When <a href="#">num lock</a> is on, the keypad can be used like an external numeric keypad.
(6)  Windows application key	<p><b>Windows 7:</b> Displays a shortcut menu for items beneath the cursor.</p> <p><b>Windows 8.1:</b> Displays options for a selected object.</p> <p><b>Windows 10:</b> Displays options for a selected object.</p>
(7) <a href="#">num lk</a> <a href="#">num lock</a> key	Turns the embedded numeric keypad on and off.

## Bottom



Component	Description
(1) 	Battery release latches (2) Release the battery.
(2)	Battery bay Holds the battery.
(3)	Vents (3) Enable airflow to cool internal components. <b>NOTE:</b> The computer fan starts up automatically to cool internal components and prevent overheating. It is normal for the internal fan to cycle on and off during routine operation. <b>NOTE:</b> The vents shown in this illustration may vary depending on your computer model.
(4) 	Service door Provides access to the hard drive bay, the wireless LAN (WLAN) module slot, and the memory module slots.

Component	Description
	<p><b>CAUTION:</b> To prevent an unresponsive system, replace the wireless module only with a wireless module authorized for use in the computer by the governmental agency that regulates wireless devices in your country or region. If you replace the module and then receive a warning message, remove the module to restore computer functionality, and then contact support.</p> <p>To access Help and Support in <b>Windows 7</b>: Select <b>Start &gt; Help and Support</b>.</p> <p>To access HP Support Assistant: in <b>Windows 8.1</b>: From the Start screen, select the <b>HP Support Assistant</b> app.</p> <p><b>Windows 10:</b></p> <p>Type <code>support</code> in the taskbar search box, and then select the <b>HP Support Assistant</b> app.</p> <p>- or -</p> <p>Click the question mark icon in the taskbar.</p>

# Labels

The labels affixed to the computer provide information you may need when you troubleshoot system problems or travel internationally with the computer.

**IMPORTANT:** Check the following locations for the labels described in this section: the bottom of the computer, inside the battery bay, under the service door, or on the back of the display.

- Service label—Provides important information to identify your computer. When contacting support, you will probably be asked for the serial number, and possibly for the product number or the model number. Locate these numbers before you contact support.

Your service label will resemble one of the examples shown below. Refer to the illustration that most closely matches the service label on your computer.



---

### Component

- (1) Serial number
  - (2) Product number
  - (3) Warranty period
  - (4) Model number (select products only)
- 

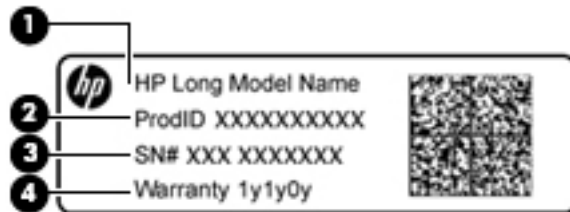

---

### Component

- (1) Model name (select products only)
  - (2) Product number
  - (3) Serial number
  - (4) Warranty period
- 

- Regulatory label(s)—Provide(s) regulatory information about the computer.
- Wireless certification label(s)—Provide(s) information about optional wireless devices and the approval markings for the countries or regions in which the devices have been approved for use.

---

## 3 Illustrated parts catalog

### Computer major components

---

 **NOTE:** HP continually improves and changes product parts. For complete and current information on supported parts for your computer, go to <http://partsurfer.hp.com>, select your country or region, and then follow the on-screen instructions.

 **NOTE:** Details about your computer, including model, serial number, product key, and length of warranty, are on the service tag at the bottom of your computer. See [Labels on page 17](#) for details.

---

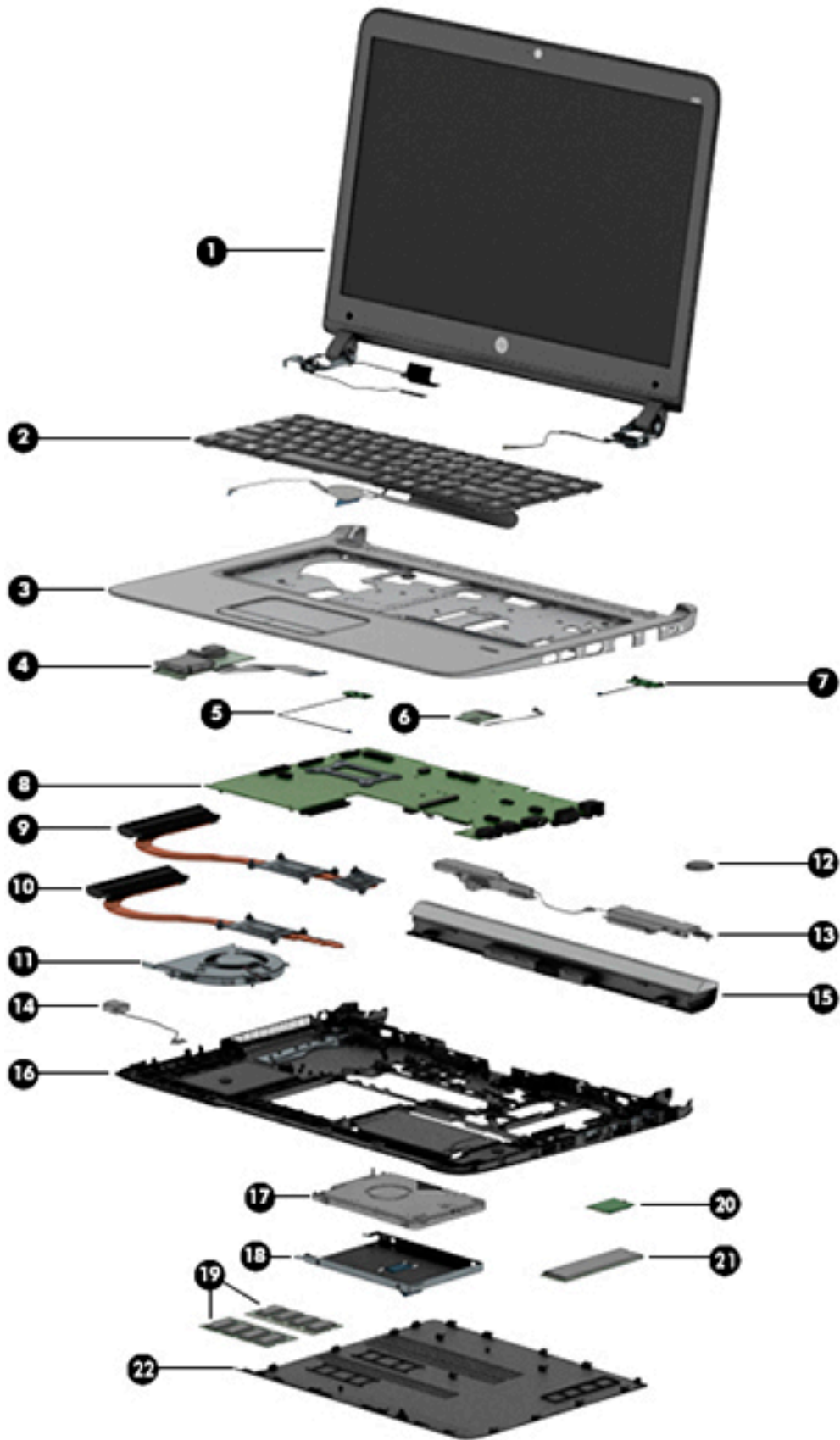

Item	Description	Spare part number
<b>(1)</b>	<b>Display panel assembly, 35.6-cm (14.0-inch)</b>  <b>NOTE:</b> Touch displays are not spared an the subcomponent level – touch display are only spared as full hinge-ups.  Non-touch displays are ONLY spared at the subcomponent level – non-touch displays are not spared as full-hinge-ups. For more information about non-touch display components, see <a href="#">Display components on page 22</a> .	
	Touch screen (full hinge-up), includes one antenna	826400-001
	Touch screen (full hinge-up), includes two antennas	826401-001
<b>(2)</b>	<b>Keyboard (includes cable)</b>  <b>NOTE:</b> For a detailed list of keyboard country codes, see <a href="#">Keyboard on page 42</a> .	
	No backlight	826367-xxx
	Backlit	826368-xxx
<b>(3)</b>	<b>Top cover (includes touchpad assembly)</b>	829015-001
<b>(4)</b>	<b>USB/audio/card reader board</b>	826374-001
<b>(5)</b>	<b>Power button board assembly</b>	826387-001
<b>(6)</b>	<b>Function board</b>	826381-001
<b>(7)</b>	<b>Fingerprint reader assembly (includes cable and bracket)</b>	829011-001
<b>(8)</b>	<b>System board (includes replacement thermal material)</b>  All system boards use the following part numbers:  xxxxxx-001: Windows 7 or non-Windows operating systems xxxxxx-601: Windows 8.1 or Windows 10 operating system	
	Intel Core i7-6500U processor; 2-GB discrete graphics memory	830947-xxx
	Intel Core i5-6300U processor; 2-GB discrete graphics memory	830946-xxx
	Intel Core i5-6200U processor; 2-GB discrete graphics memory	830945-xxx
	Intel Core i3-6100U processor; 2-GB discrete graphics memory	830944-xxx
	Intel Core i3-6100U processor; 1-GB discrete graphics memory	830943-xxx
	Intel Core i7-6500U processor; UMA graphics memory	830940-xxx
	Intel Core i5-6300U processor; UMA graphics memory	830939-xxx
	Intel Core i5-6200U processor; UMA graphics memory	830937-xxx
	Intel Core i3-6100U processor; UMA graphics memory	830935-xxx
	Intel Pentium 4405U processor; UMA graphics memory	830942-xxx
	Intel Celeron 3855U processor; UMA graphics memory	830934-xxx
	<b>Heat sink assembly (includes replacement thermal material)</b>	
<b>(9)</b>	For use in models with discrete graphics	826404-001
<b>(10)</b>	For use in models with UMA graphics	829012-001
<b>(11)</b>	<b>Fan</b>	829010-001



<b>Item</b>	<b>Description</b>	<b>Spare part number</b>
<b>(12)</b>	<b>RTC battery</b>	826388-001
<b>(13)</b>	<b>Speaker assembly</b>	829014-001
<b>(14)</b>	<b>Power connector cable</b>	827039-001
<b>(15)</b>	<b>Battery, Li-ion</b>	
	6-cell, 55 WHr, 2.8 Ah	811347-001
	4-cell, 44 WHr, 3.0 Ah	805292-001
<b>(16)</b>	<b>Base enclosure</b>	829008-001
<b>(17)</b>	<b>Hard drive</b>	
	1 TB, 5400 rpm, 7 mm	762990-001
	750 GB, 5400 rpm, 7 mm	752099-001
	500 GB, 5400 rpm, 7 mm	778186-001
	500 GB, 5400 rpm, 7 mm, hybrid (8-GB SSD)	732000-001
	500 GB, 7200 rpm, 7 mm	703267-001
<b>(18)</b>	<b>Hard drive Hardware Kit</b> (includes bracket and screws)	826382-001
<b>(19)</b>	<b>Memory modules</b> (PC3L-12800, 1600-MHz, DDR3L)	
	8-GB	693374-001
	4-GB	691740-001
	2-GB	691739-001
<b>(20)</b>	<b>WLAN module</b>	
	Realtek RTL8188EE 802.11b/g/n 1x1 Wi-Fi Adapter (Worldwide)	792609-001
	Realtek RTL8723BE 802.11b/g/n 1x1 Wi-Fi + BT4.0 Combo Adapter (Worldwide)	792610-001
	Realtek RTL8723BE bgn 1x1 + BT 4 LE PCIe+USB NGFF 2230 M.2 (Worldwide)	792611-001
	Broadcom 943228 abgn 2x2 + BT 4 LE PCIe+USB NGFF 2230 MOW (Most of World)	797884-001
	7260NGW Intel Dual Band Wireless-AC 7260 802.11ac, Dual Band, 2x2 Wi-Fi + Bluetooth 4.0	806722-001
	Intel Dual Band Wireless-AC 3165 802.11ac, Dual Band, 1x1 Wi-Fi + Bluetooth 4.0 (Most of World)	806723-001
	Intel Dual Band Wireless-AC 3160 802.11ac, Dual Band, 1x1, Wi-Fi + Bluetooth 4.0 (only for use in Brazil)	810813-205
<b>(21)</b>	<b>Solid-state drive, M.2</b>	
	256-GB, TLC	826393-001
	128-GB, TLC	826392-001
	<b>Plastics Kit</b> , includes:	829013-001
<b>(22)</b>	<b>Service door</b>	
	Fingerprint reader insert (for models without a fingerprint reader)(not illustrated)	

# Display components

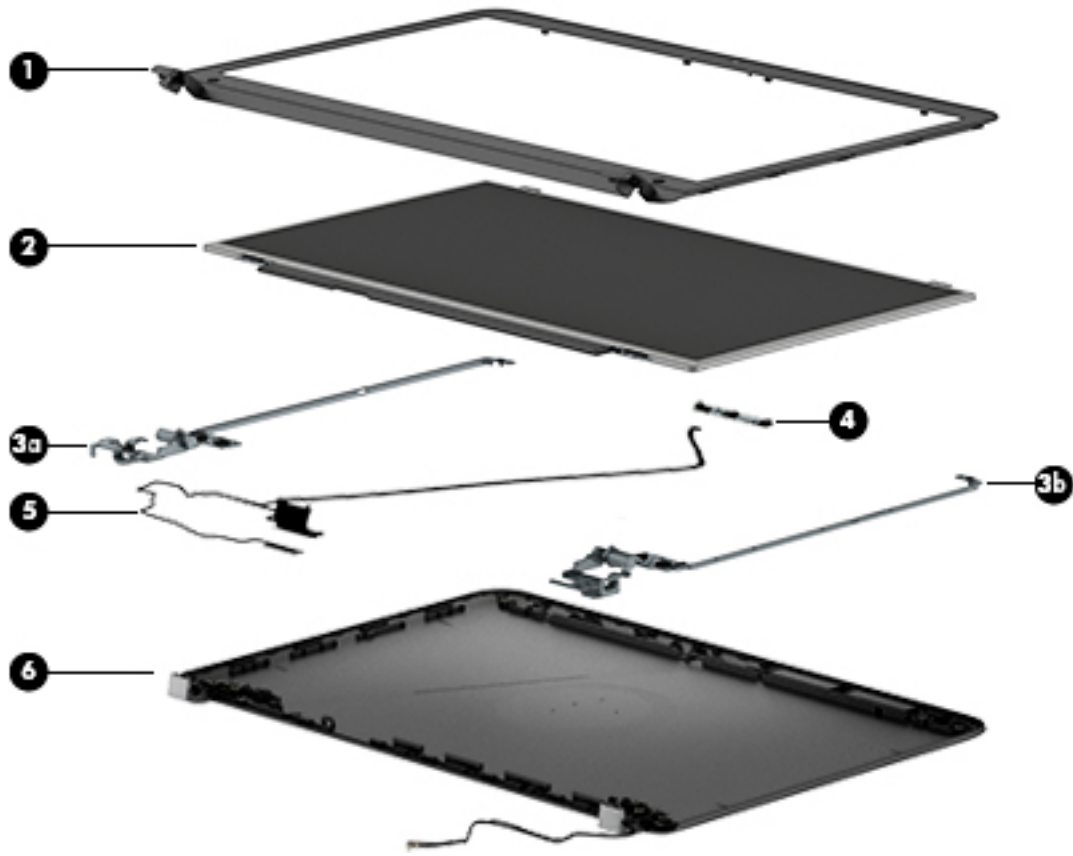

Item	Description	Spare part number
<b>(1)</b>	<b>Display bezel</b>	
	For use in models with a webcam	826397-001
	For use in models without a webcam	826398-001
<b>(2)</b>	<b>Display panel (raw)</b>	
	FHD, slim	826402-001
	HD, flat	826403-001
	<b>Display Hinge Kit</b> , includes:	826405-001
<b>(3a)</b>	Left hinge	
<b>(3b)</b>	Right hinge	
<b>(4)</b>	<b>Webcam module</b>	826395-001
	<b>Microphone module</b>	826385-001
<b>(5)</b>	<b>Display/webcam cable assembly</b>	826399-001 (Cable Kit)
	Included in Cable Kit, 826399-001	
<b>(6)</b>	<b>Display rear cover</b> (includes wireless antennas)	826396-001

## Cable Kit

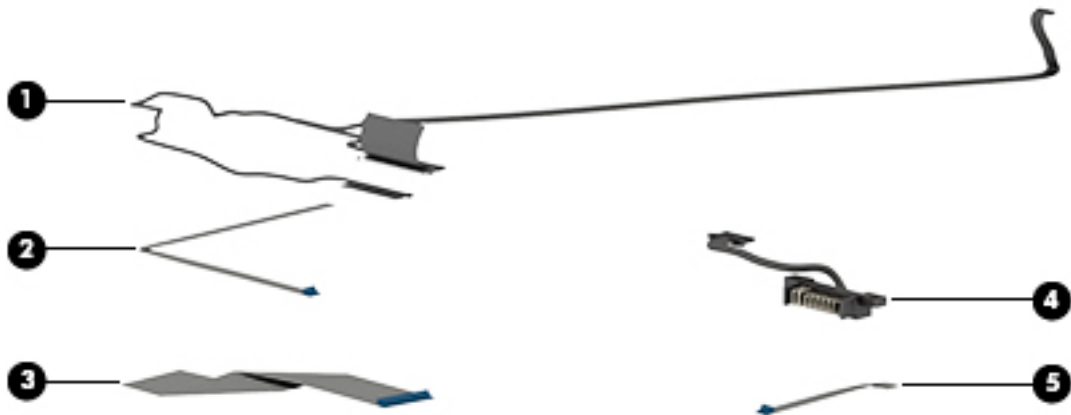

Item	Description	Spare part number
	<b>Cable Kit</b>	826399-001
(1)	Display/webcam cable	
(2)	Power button board cable	
(3)	Card reader cable	
(4)	Battery connector cable	
(5)	Function board cable	

## Plastics Kit



Item	Description	Spare part number
	<b>Plastics Kit</b>	829013-001
(1)	Service door	
(2)	Fingerprint reader insert (for use in models without a fingerprint reader)	

## Mass storage devices

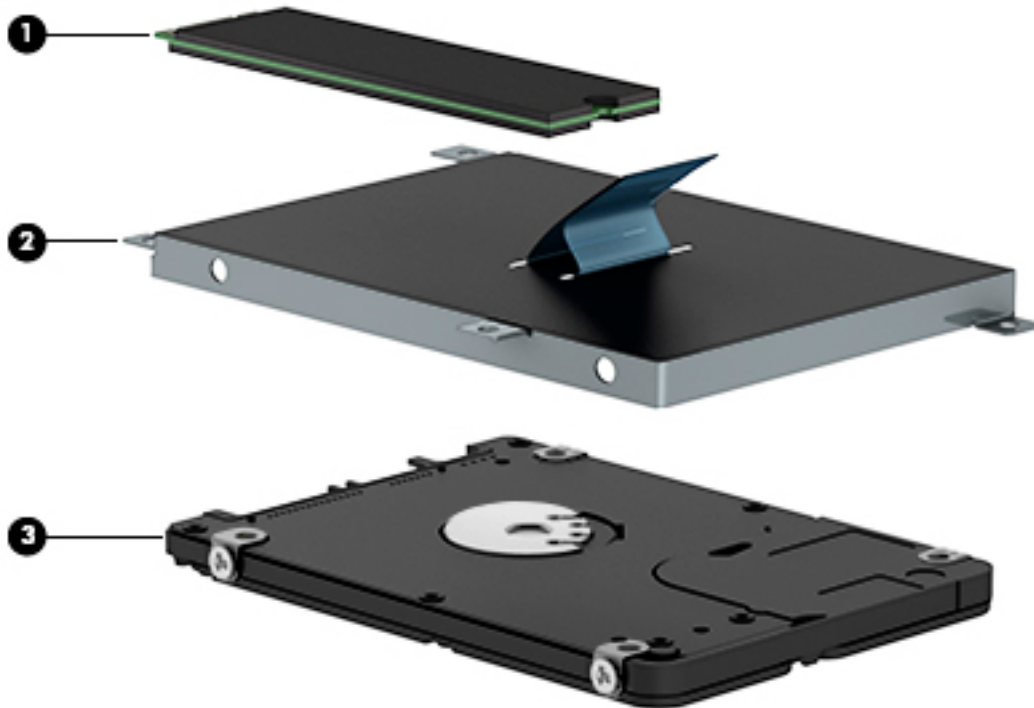

Item	Description	Spare part number
<b>(1)</b>	<b>Solid-state drives, M.2</b>	
	256-GB, TLC	826393-001
	128-GB, TLC	826392-001
	<b>Hard Drive Hardware Kit</b> , includes:	826382-001
<b>(2)</b>	Hard drive bracket	
	Screws (not illustrated)	
<b>(3)</b>	<b>Hard drives</b>	
	1 TB, 5400 rpm, 7 mm	762990-001
	750 GB, 5400 rpm, 7 mm	752099-001
	500 GB, 5400 rpm, 7 mm	778186-001
	500 GB, 5400 rpm, 7 mm, hybrid (8-GB SSD)	732000-001
	500 GB, 7200 rpm, 7 mm	703267-001

## Miscellaneous parts

Description	Spare part number
<b>AC adapters</b>	
65-W Smart AC power adapter, 4.5 mm barrel connector	710412-001
65-W Smart AC power adapter, 4.5 mm barrel connector (for use only in Asia, the People's Republic of China, and India)	714657-001
45-W AC adapter, 4.5 mm barrel connector (for use in Japan)	742436-001
45-W AC adapter, 4.5 mm barrel connector	741727-001
<b>Power cords, 1.83 m, 3-pin:</b>	
For use in Argentina	490371-D01
For use in Australia	490371-011
For use in Brazil	490371-202
For use in Denmark	490371-081
For use in Europe, the Middle East, and Africa	490371-021
For use in India	490371-D61
For use in Israel	490371-BB1
For use in Italy	490371-061
For use in Japan	490371-291
For use in the People's Republic of China	490371-AA1
For use in South Africa	490371-AR1
For use in South Korea	490371-AD1
For use in Switzerland	490371-111
For use in Taiwan	490371-AB1
For use in Thailand	490371-201
For use in the United Kingdom	490371-031
For use in the United States	490371-001
<b>Power cords, 1.0 m, 3-pin:</b>	
For use in Argentina	755530-D01
For use in Australia	755530-011
For use in Brazil	755530-202
For use in Denmark	755530-081
For use in Europe, the Middle East, and Africa	755530-021
For use in India	755530-D61
For use in Israel	755530-BB1
For use in Italy	755530-061

Description	Spare part number
For use in Japan	755530-291
For use in the People's Republic of China	755530-AA1
For use in South Africa	755530-AR1
For use in South Korea	755530-AD1
For use in Switzerland	755530-111
For use in Taiwan	755530-AB1
For use in Thailand	755530-201
For use in the United Kingdom	755530-031
For use in the United States	755530-001
<b>Rubber Kit</b> (includes rubber base enclosure screw covers, mylar display bezel screw covers, and display bezel rubber caps)	826407-001
<b>Screw Kit</b>	826408-001

---

## 4 Removal and replacement procedures preliminary requirements

### Tools required

You will need the following tools to complete the removal and replacement procedures:

- Flat-bladed screwdriver
- Phillips P0 and P1 screwdrivers
- Torx T8 screwdriver

### Service considerations

The following sections include some of the considerations that you must keep in mind during disassembly and assembly procedures.

---

 **NOTE:** As you remove each subassembly from the computer, place the subassembly (and all accompanying screws) away from the work area to prevent damage.

---

### Plastic parts

---

 **CAUTION:** Using excessive force during disassembly and reassembly can damage plastic parts. Use care when handling the plastic parts. Apply pressure only at the points designated in the maintenance instructions.

---

## Cables and connectors

---

**⚠ CAUTION:** When servicing the computer, be sure that cables are placed in their proper locations during the reassembly process. Improper cable placement can damage the computer.

---

Cables must be handled with extreme care to avoid damage. Apply only the tension required to unseat or seat the cables during removal and insertion. Handle cables by the connector whenever possible. In all cases, avoid bending, twisting, or tearing cables. Be sure that cables are routed in such a way that they cannot be caught or snagged by parts being removed or replaced. Handle flex cables with extreme care; these cables tear easily.

## Drive handling

---

**⚠ CAUTION:** Drives are fragile components that must be handled with care. To prevent damage to the computer, damage to a drive, or loss of information, observe these precautions:

Before removing or inserting a hard drive, shut down the computer. If you are unsure whether the computer is off or in Hibernation, turn the computer on, and then shut it down through the operating system.

Before handling a drive, be sure that you are discharged of static electricity. While handling a drive, avoid touching the connector.

Before removing a diskette drive or optical drive, be sure that a diskette or disc is not in the drive and be sure that the optical drive tray is closed.

Handle drives on surfaces covered with at least one inch of shock-proof foam.

Avoid dropping drives from any height onto any surface.

After removing a hard drive, an optical drive, or a diskette drive, place it in a static-proof bag.

Avoid exposing a hard drive to products that have magnetic fields, such as monitors or speakers.

Avoid exposing a drive to temperature extremes or liquids.

If a drive must be mailed, place the drive in a bubble pack mailer or other suitable form of protective packaging and label the package “FRAGILE.”

---



# Grounding guidelines

## Electrostatic discharge damage

Electronic components are sensitive to electrostatic discharge (ESD). Circuitry design and structure determine the degree of sensitivity. Networks built into many integrated circuits provide some protection, but in many cases, ESD contains enough power to alter device parameters or melt silicon junctions.

A discharge of static electricity from a finger or other conductor can destroy static-sensitive devices or microcircuitry. Even if the spark is neither felt nor heard, damage may have occurred.

An electronic device exposed to ESD may not be affected at all and can work perfectly throughout a normal cycle. Or the device may function normally for a while, and then degrade in the internal layers, reducing its life expectancy.

**CAUTION:** To prevent damage to the computer when you are removing or installing internal components, observe these precautions:

Keep components in their electrostatic-safe containers until you are ready to install them.

Use nonmagnetic tools.

Before touching an electronic component, discharge static electricity by using the guidelines described in this section.

Avoid touching pins, leads, and circuitry. Handle electronic components as little as possible.

If you remove a component, place it in an electrostatic-safe container.

The following table shows how humidity affects the electrostatic voltage levels generated by different activities.

**CAUTION:** A product can be degraded by as little as 700 V.

Typical electrostatic voltage levels			
Event	Relative humidity		
	10%	40%	55%
Walking across carpet	35,000 V	15,000 V	7,500 V
Walking across vinyl floor	12,000 V	5,000 V	3,000 V
Motions of bench worker	6,000 V	800 V	400 V
Removing DIPs from plastic tube	2,000 V	700 V	400 V
Removing DIPs from vinyl tray	11,500 V	4,000 V	2,000 V
Removing DIPs from Styrofoam	14,500 V	5,000 V	3,500 V
Removing bubble pack from PCB	26,500 V	20,000 V	7,000 V
Packing PCBs in foam-lined box	21,000 V	11,000 V	5,000 V

## Packaging and transporting guidelines

Follow these grounding guidelines when packaging and transporting equipment:

- To avoid hand contact, transport products in static-safe tubes, bags, or boxes.
- Protect ESD-sensitive parts and assemblies with conductive or approved containers or packaging.
- Keep ESD-sensitive parts in their containers until the parts arrive at static-free workstations.
- Place items on a grounded surface before removing items from their containers.
- Always be properly grounded when touching a component or assembly.
- Store reusable ESD-sensitive parts from assemblies in protective packaging or nonconductive foam.
- Use transporters and conveyors made of antistatic belts and roller bushings. Be sure that mechanized equipment used for moving materials is wired to ground and that proper materials are selected to avoid static charging. When grounding is not possible, use an ionizer to dissipate electric charges.

## Workstation guidelines

Follow these grounding workstation guidelines:

- Cover the workstation with approved static-shielding material.
- Use a wrist strap connected to a properly grounded work surface and use properly grounded tools and equipment.
- Use conductive field service tools, such as cutters, screwdrivers, and vacuums.
- When fixtures must directly contact dissipative surfaces, use fixtures made only of static-safe materials.
- Keep the work area free of nonconductive materials, such as ordinary plastic assembly aids and Styrofoam.
- Handle ESD-sensitive components, parts, and assemblies by the case or PCM laminate. Handle these items only at static-free workstations.
- Avoid contact with pins, leads, or circuitry.
- Turn off power and input signals before inserting or removing connectors or test equipment.

## Equipment guidelines

Grounding equipment must include either a wrist strap or a foot strap at a grounded workstation.

- When seated, wear a wrist strap connected to a grounded system. Wrist straps are flexible straps with a minimum of one megohm  $\pm 10\%$  resistance in the ground cords. To provide proper ground, wear a strap snugly against the skin at all times. On grounded mats with banana-plug connectors, use alligator clips to connect a wrist strap.
- When standing, use foot straps and a grounded floor mat. Foot straps (heel, toe, or boot straps) can be used at standing workstations and are compatible with most types of shoes or boots. On conductive floors or dissipative floor mats, use foot straps on both feet with a minimum of one megohm resistance between the operator and ground. To be effective, the conductive strips must be worn in contact with the skin.

The following grounding equipment is recommended to prevent electrostatic damage:

- Antistatic tapes
- Antistatic smocks, aprons, and sleeve protectors
- Conductive bins and other assembly or soldering aids
- Nonconductive foam
- Conductive tabletop workstations with ground cords of one megohm resistance
- Static-dissipative tables or floor mats with hard ties to the ground
- Field service kits
- Static awareness labels
- Material-handling packages
- Nonconductive plastic bags, tubes, or boxes
- Metal tote boxes
- Electrostatic voltage levels and protective materials

The following table lists the shielding protection provided by antistatic bags and floor mats.

Material	Use	Voltage protection level
Antistatic plastic	Bags	1,500 V
Carbon-loaded plastic	Floor mats	7,500 V
Metallized laminate	Floor mats	5,000 V

---

## 5 Removal and replacement procedures for Customer Self-Repair parts

---

 **CAUTION:** The Customer Self-Repair program is not available in all locations. Installing a part not supported by the Customer Self-Repair program may void your warranty. Check your warranty to determine if Customer Self-Repair is supported in your location.

 **NOTE:** HP continually improves and changes product parts. For complete and current information on supported parts for your computer, go to <http://partsurfer.hp.com>, select your country or region, and then follow the on-screen instructions.

---

### Component replacement procedures

---

 **NOTE:** Please read and follow the procedures described here to access and replace Customer Self-Repair parts successfully.

 **NOTE:** Details about your computer, including model, serial number, product key, and length of warranty, are on the service tag at the bottom of your computer. See [Labels on page 17](#) for details.

---

This chapter provides removal and replacement procedures for Customer Self-Repair parts.

There are as many as 13 screws that must be removed, replaced, or loosened when servicing Customer Self-Repair parts. Make special note of each screw size and location during removal and replacement.

## Battery

Description	Spare part number
6-cell, 55 WHr, 2.8 Ah	811347-001
4-cell, 44 WHr, 3.0 Ah	805292-001

Before removing the battery, follow these steps:

1. Shut down the computer. If you are unsure whether the computer is off or in Hibernation, turn the computer on, and then shut it down through the operating system.
2. Disconnect all external devices connected to the computer.
3. Disconnect the power from the computer by first unplugging the power cord from the AC outlet, and then unplugging the AC adapter from the computer.

To remove the battery:

**⚠ CAUTION:** Removing a battery that is the sole power source for the computer can cause loss of information. To prevent loss of information, save your work and shut down the computer through Windows before removing the battery.

1. Position the computer upside down on a flat surface.
2. Slide the battery release latches **(1)** to release the battery.

**📝 NOTE:** You can slide the battery release latches simultaneously or you can slide them one at a time.

**📝 NOTE:** Each battery release latch automatically return to its original position.

3. Remove the battery from the computer **(2)**.

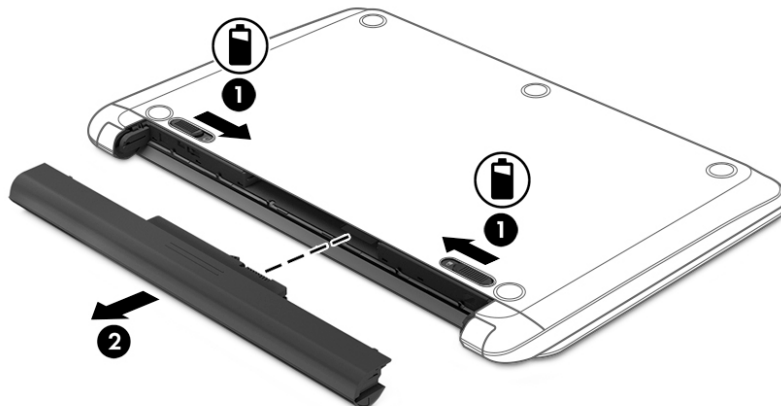

## Service door

Description	Spare part number
Plastics Kit (includes service door)	829013-001

Before removing the service door, follow these steps:

1. Shut down the computer. If you are unsure whether the computer is off or in Hibernation, turn the computer on, and then shut it down through the operating system.
2. Disconnect all external devices connected to the computer.
3. Disconnect the power from the computer by first unplugging the power cord from the AC outlet, and then unplugging the AC adapter from the computer.
4. Remove the battery (see [Battery on page 33](#)).

To remove the service door:

1. With the battery bay away from you, remove the service door screw cover (1).
2. Loosen the service door screw (2).
3. Slide the service door away from the battery bay (3) to release it, and then lift the service door (4) to remove it.

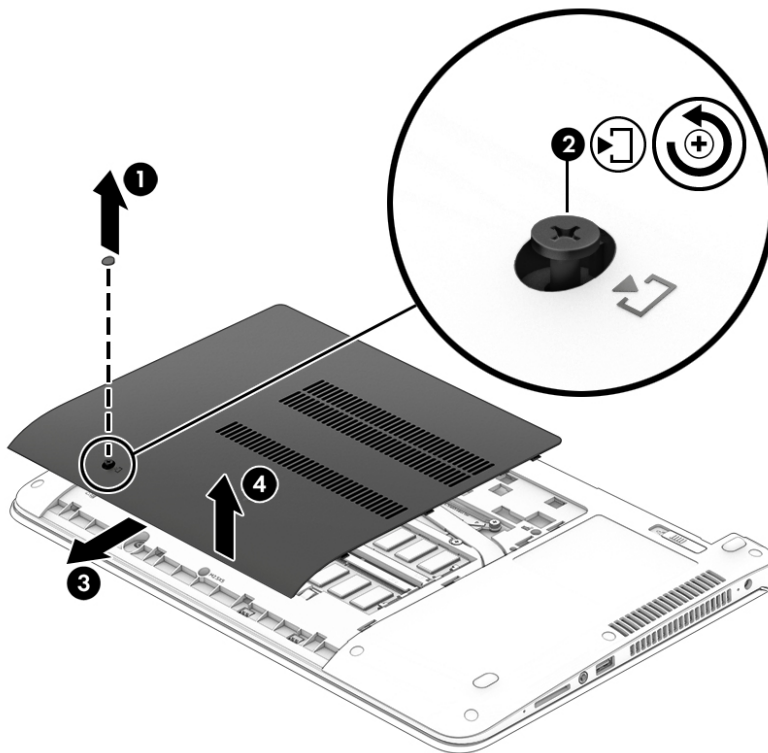

Reverse these procedures to install the service door.

## Hard drive

Description	Spare part number
<b>Hard drives</b>	
1 TB, 5400 rpm, 7 mm	762990-001
750 GB, 5400 rpm, 7 mm	752099-001
500 GB, 5400 rpm, 7 mm	778186-001
500 GB, 5400 rpm, 7 mm, hybrid (8-GB SSD)	732000-001
500 GB, 7200 rpm, 7 mm	703267-001

Before removing the hard drive, follow these steps:

1. Shut down the computer. If you are unsure whether the computer is off or in Hibernation, turn the computer on, and then shut it down through the operating system.
2. Disconnect all external devices connected to the computer.
3. Disconnect the power from the computer by first unplugging the power cord from the AC outlet, and then unplugging the AC adapter from the computer.
4. Remove the battery (see [Battery on page 33](#)).
5. Remove the service door (see [Service door on page 34](#)).

To remove a hard drive:

1. Remove the 4 Phillips PM2.5×5.0 screws **(1)** that secure the hard drive to the chassis.
2. Pull the plastic tab to slide the hard drive **(2)** away from the center of the computer to disengage it from the connector.
3. Remove the hard drive from the bay **(3)**.

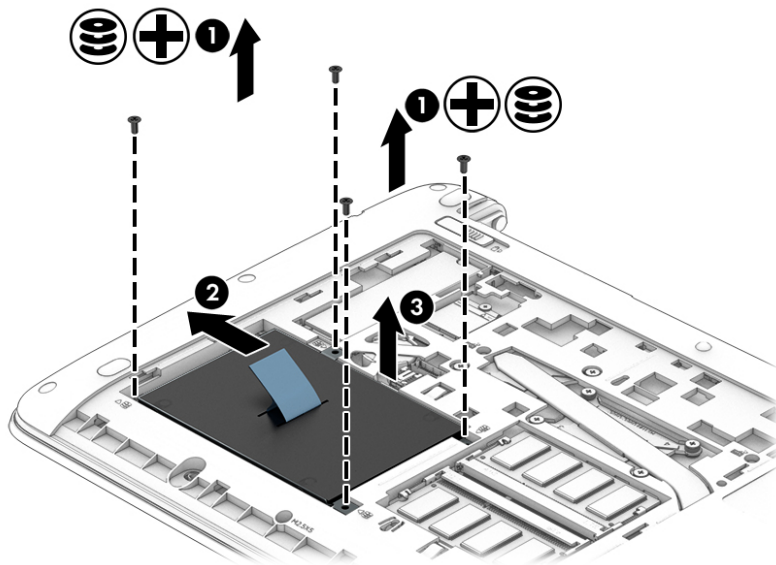

4. To remove the hard drive cover from the hard drive, remove the 4 Phillips PM3.0×3.5 screws **(1)** that secure the bracket to the drive, and then lift the cover off the drive **(2)**.

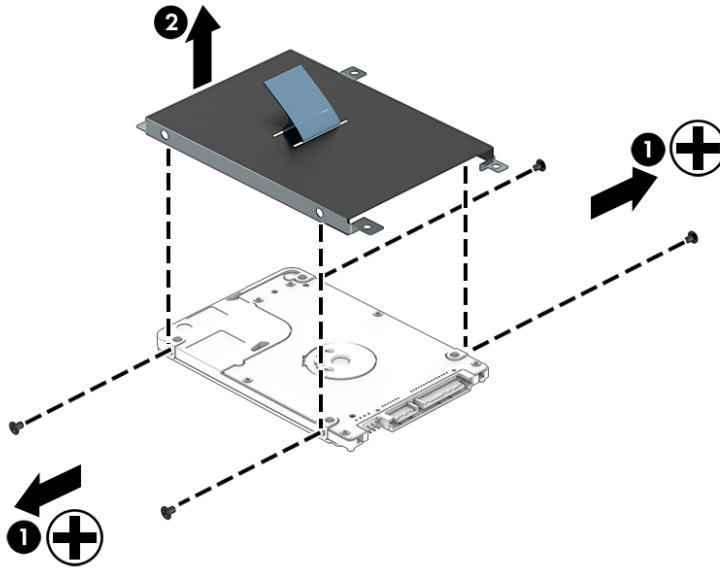

Reverse these procedures to install a hard drive.



## Memory modules

Description	Spare part number
2-GB (PC3L-12800, 1600-MHz, DDR3L)	691739-001
4-GB (PC3L-12800, 1600-MHz, DDR3L)	691740-001
8-GB (PC3L-12800, 1600-MHz, DDR3L)	693374-001

### Update BIOS before adding memory modules

Before adding new memory, make sure you update the computer to the latest BIOS.

 **CAUTION:** Failure to update the computer to the latest BIOS prior to installing new memory may result in various system problems.

To update BIOS:

1. Navigate to [www.hp.com](http://www.hp.com).
2. Click **Support & Drivers** > click **Drivers & Software**.
3. In the **Enter a product name/number** box, type the computer model information, and then click **Search**.
4. Click the link for the computer model.
5. Select the operating system, and then click **Next**.
6. Under **Step 2: Select a Download**, click the **BIOS** link.
7. Click the link for the most recent BIOS.
8. Click the **Download** button, and then follow the on-screen instructions.

Before removing the memory module, follow these steps:

1. Shut down the computer. If you are unsure whether the computer is off or in Hibernation, turn the computer on, and then shut it down through the operating system.
2. Disconnect all external devices connected to the computer.
3. Disconnect the power from the computer by first unplugging the power cord from the AC outlet, and then unplugging the AC adapter from the computer.
4. Remove the battery (see [Battery on page 33](#)).
5. Remove the service door (see [Service door on page 34](#)).

Remove the memory module:

1. Spread the retaining tabs **(1)** on each side of the memory module slot to release the memory module. (The edge of the module opposite the slot rises away from the computer.)

2. Remove the memory module **(2)** by pulling the module away from the slot at an angle.

---

 **NOTE:** Memory modules are designed with a notch to prevent incorrect insertion into the memory module slot.

 **NOTE:** The computer uses two memory sockets. The top socket houses the expansion memory module and the bottom socket houses the primary memory module. The removal procedure is the same for both memory sockets.

---

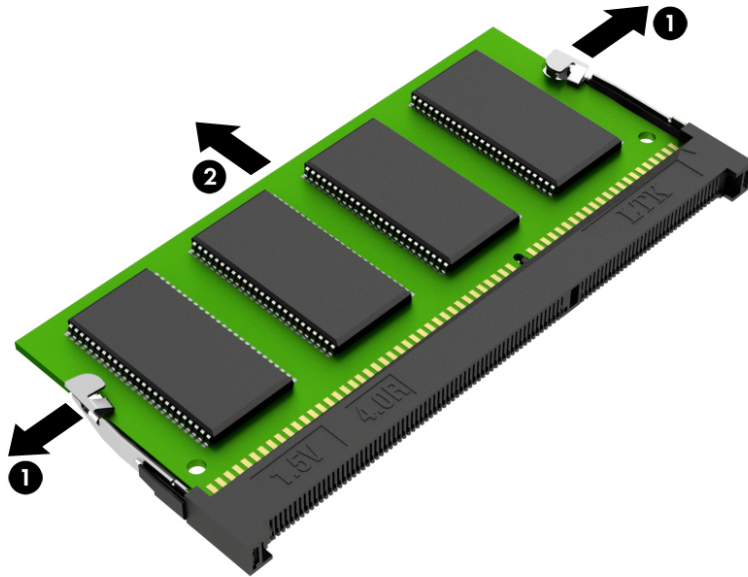

Reverse this procedure to install a memory module.

## WLAN/Bluetooth combo card

The computer uses a card that provides both WLAN and Bluetooth functionality.

Description	Spare part number
Realtek RTL8188EE 802.11b/g/n 1x1 Wi-Fi Adapter (Worldwide)	792609-001
Realtek RTL8723BE 802.11b/g/n 1x1 Wi-Fi + BT4.0 Combo Adapter (Worldwide)	792610-001
Realtek RTL8723BE bgn 1x1 + BT 4 LE PCIe+USB NGFF 2230 M.2 (Worldwide)	792611-001
Broadcom 943228 abgn 2x2 + BT 4 LE PCIe+USB NGFF 2230 MOW (Most of World)	797884-001
7260NGW Intel Dual Band Wireless-AC 7260 802.11ac, Dual Band, 2x2 Wi-Fi + Bluetooth 4.0	806722-001
Intel Dual Band Wireless-AC 3165 802.11ac, Dual Band, 1x1 Wi-Fi + Bluetooth 4.0 (Most of World)	806723-001
Intel Dual Band Wireless-AC 3160 802.11ac, Dual Band, 1x1, Wi-Fi + Bluetooth 4.0 (only for use in Brazil)	810813-205

Before removing the WLAN module, follow these steps:

1. Shut down the computer. If you are unsure whether the computer is off or in Hibernation, turn the computer on, and then shut it down through the operating system.
2. Disconnect all external devices connected to the computer.
3. Disconnect the power from the computer by first unplugging the power cord from the AC outlet, and then unplugging the AC adapter from the computer.
4. Remove the battery (see [Battery on page 33](#)).
5. Remove the service door (see [Service door on page 34](#)).

Remove the WLAN module:

1. Disconnect the WLAN antenna cables (**1**) from the terminals on the WLAN module.





**NOTE:** The WLAN antenna cable labeled “1” connects to the WLAN module “Main” terminal labeled “1”. The WLAN antenna cable labeled “2” connects to the WLAN module “Aux” terminal labeled “2”. If the computer is equipped with an 802.11a/b/g/n WLAN module, the yellow WLAN antenna cable connects to the middle terminal on the WLAN module.

2. Remove the Phillips PM2.0x4.0 screw (**2**) that secures the WLAN module to the computer. (The edge of the module opposite the slot rises away from the computer.)

3. Remove the WLAN module **(3)** by pulling the module away from the slot at an angle.

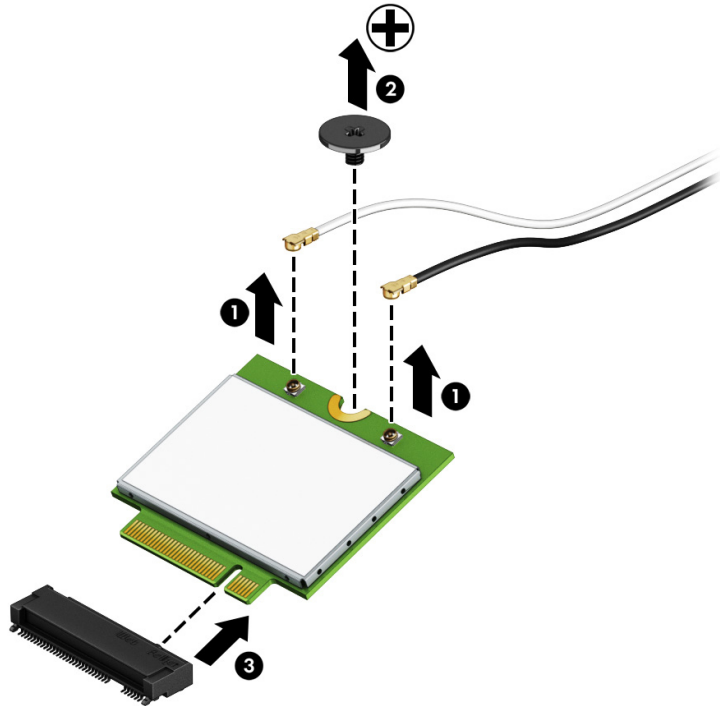
 **NOTE:** WLAN modules are designed with a notch to prevent incorrect insertion.



 **NOTE:** If the WLAN antennas are not connected to the terminals on the WLAN module, the protective sleeves must be installed on the antenna connectors, as shown in the following illustration.

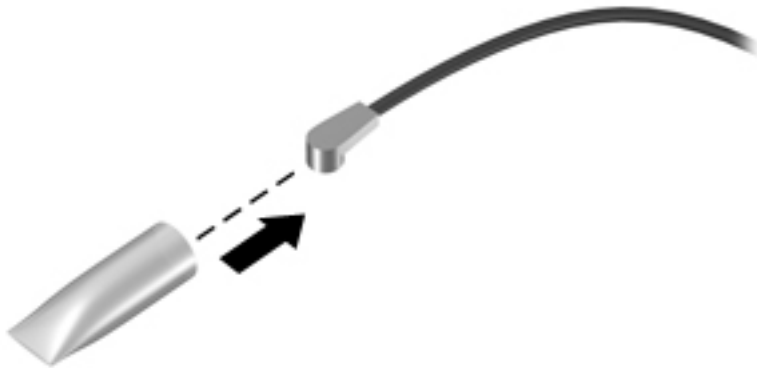

Reverse this procedure to install the WLAN module.

## M.2 solid-state drive

Description	Spare part number
256-GB, TLC	826393-001
128-GB, TLC	826392-001

Before removing the solid-state drive, follow these steps:

1. Shut down the computer. If you are unsure whether the computer is off or in Hibernation, turn the computer on, and then shut it down through the operating system.
2. Disconnect all external devices connected to the computer.
3. Disconnect the power from the computer by first unplugging the power cord from the AC outlet, and then unplugging the AC adapter from the computer.
4. Remove the battery (see [Battery on page 33](#)).
5. Remove the service door (see [Service door on page 34](#)).

Remove the solid-state drive:

1. Remove the Phillips PM2.0×4.0 screw **(1)** that secures the solid-state drive to the computer. (The edge of the module opposite the slot rises away from the computer.)
2. Remove the solid-state drive **(2)** by pulling the module away from the slot at an angle.

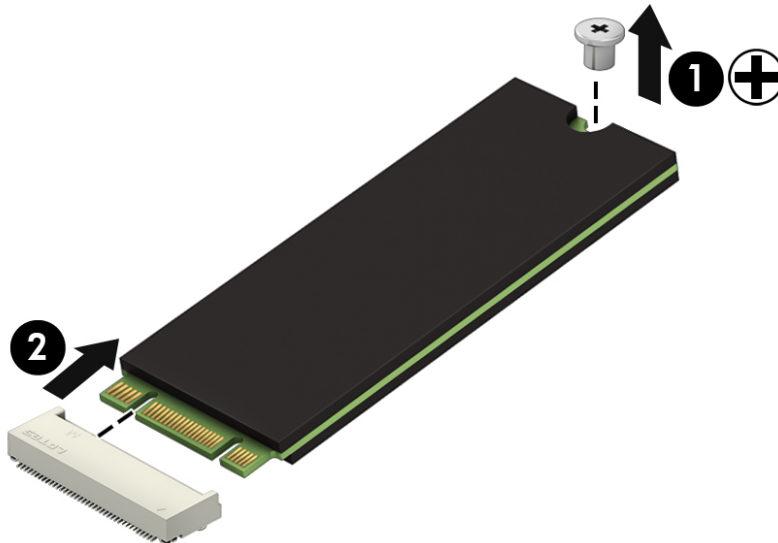

Reverse this procedure to install the solid-state drive.

## Keyboard

In this section, the first table provides the main spare part number for the keyboards. The second table provides the country codes.

Description	Spare part number
Keyboard, no backlight	826367-xxx
Keyboard, backlit	826368-xxx

For use in country or region	Spare part number	For use in country or region	Spare part number	For use in country or region	Spare part number
Belgium	-A41	India	-D61	Slovenia	-BA1
Brazil	-201	Israel	-BB1	South Korea	-AD1
Bulgaria	-261	Italy	-061	Spain	-071
Canada	-DB1	Japan	-291	Switzerland	-BG1
Czech Republic and Slovakia	-FL1	Latin America	-161	Taiwan	-AB1
Denmark, Finland, and Norway	-DH1	The Netherlands	-B31	Thailand	-281
France	-051	Northern Africa	-FP1	Turkey	-141
Germany	-041	Portugal	-131	United Kingdom	-031
Greece	-151	Russia	-251	United States	-001
Hungary	-211	Saudi Arabia	-171		

Before removing the keyboard, follow these steps:

1. Shut down the computer. If you are unsure whether the computer is off or in Hibernation, turn the computer on, and then shut it down through the operating system.
2. Disconnect all external devices connected to the computer.
3. Disconnect the power from the computer by first unplugging the power cord from the AC outlet, and then unplugging the AC adapter from the computer.
4. Remove the battery (see [Battery on page 33](#)).
5. Remove the service door (see [Service door on page 34](#)).

Remove the keyboard:

1. Remove the 2 Phillips PM2.5×5.0 screws that secure the keyboard to the computer.

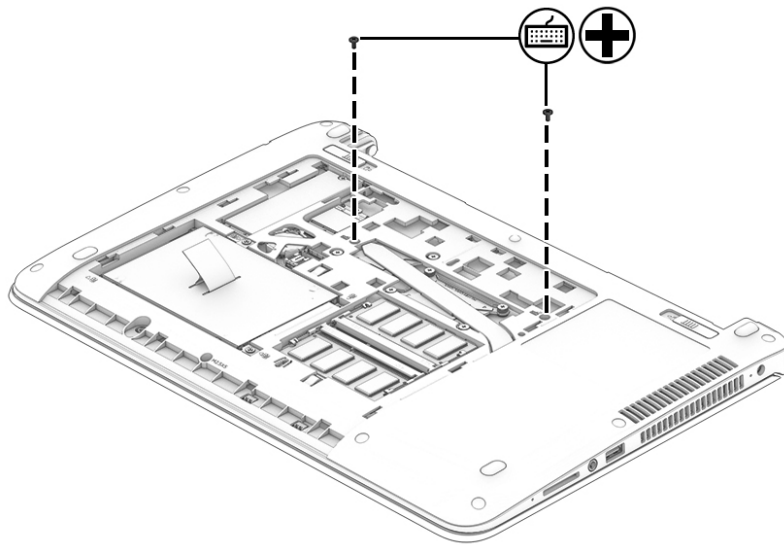

2. Open the computer and position it on its side with the bottom toward you.
3. Insert a tool into the access hole in the bottom of the computer and push to disengage the keyboard from the top cover.

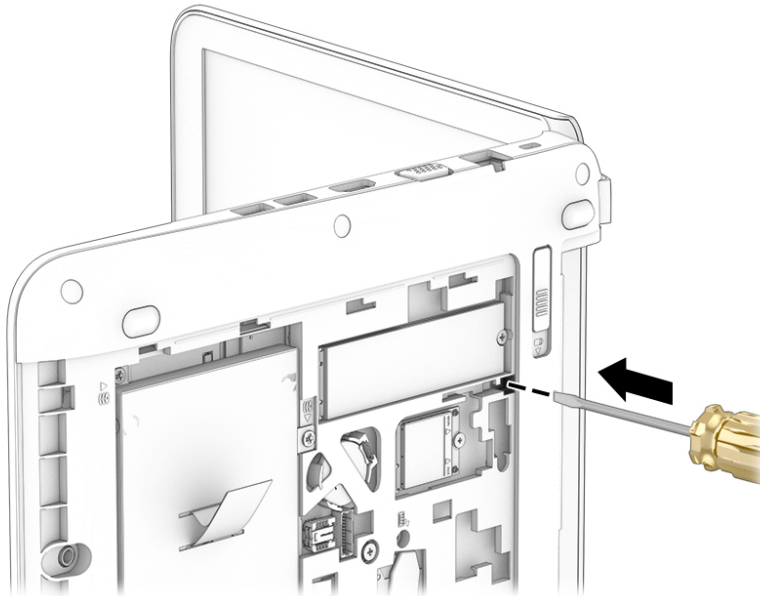

4. Lift the top of the keyboard upward **(1)**, and then lift the keyboard up at an angle **(2)** to disengage the tabs at the bottom of the keyboard.



**NOTE:** A cable (or cables) connect the bottom of the keyboard to the system board. Make sure not to prematurely pull the cables out of the system board connector.



5. Rotate the keyboard until it rests on the palm rest **(1)**.
6. If applicable, disconnect the backlight cable by lifting the connector latch **(2)**, and then disconnect the cable from the system board **(3)**.



7. Disconnect the keyboard cable by lifting the connector latch (4), and then disconnect the keyboard cable from the system board (5).

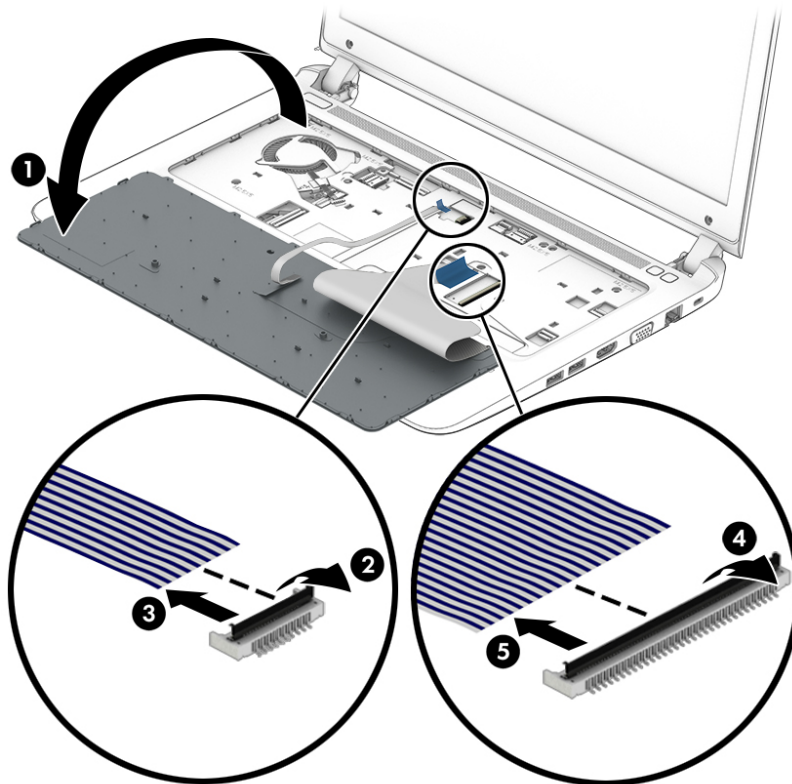

8. Remove the keyboard.

Reverse this procedure to install the keyboard.

When installing a keyboard, to make sure the keyboard lays flat, the keyboard ribbon cable must be bent at the appropriate point before installation. There are markings, typically a thin white line across the breadth of the cable, that indicate where to bend the cable. On HP ProBook 440 G3 models, bend at the marking labeled S1 (1), and then fold the cable over (2). If installing a backlit keyboard, follow the same procedures for the backlight cable.

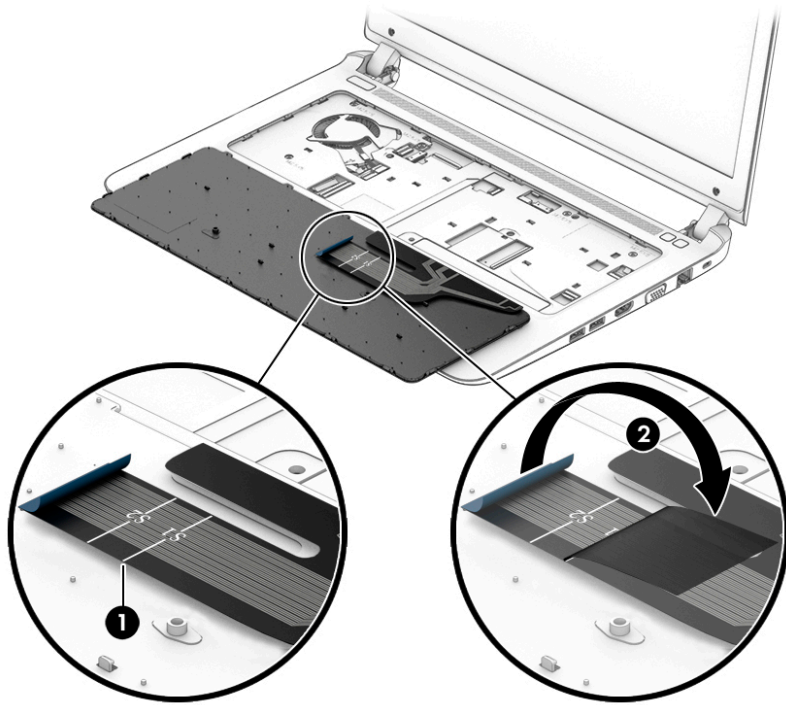

# 6 Removal and replacement procedures for Authorized Service Provider parts

 **CAUTION:** Components described in this chapter should only be accessed by an authorized service provider. Accessing these parts can damage the computer or void the warranty.

 **NOTE:** HP continually improves and changes product parts. For complete and current information on supported parts for your computer, go to <http://partsurfer.hp.com>, select your country or region, and then follow the on-screen instructions.

## Component replacement procedures

 **NOTE:** Details about your computer, including model, serial number, product key, and length of warranty, are on the service tag at the bottom of your computer. See [Labels on page 17](#) for details.

This chapter provides removal and replacement procedures for Authorized Service Provider only parts.

There are as many as 48 screws that must be removed, replaced, or loosened when servicing Authorized Service Provider only parts. Make special note of each screw size and location during removal and replacement.

### Top cover

 **NOTE:** Top cover spare part kits include the touchpad assembly.

Description	Spare part number
Top cover (includes touchpad)	829015-001

Before removing the top cover, follow these steps:

1. Shut down the computer. If you are unsure whether the computer is off or in Hibernation, turn the computer on, and then shut it down through the operating system.
2. Disconnect all external devices connected to the computer.
3. Disconnect the power from the computer by first unplugging the power cord from the AC outlet, and then unplugging the AC adapter from the computer.
4. Remove the following components:
  - a. Battery (see [Battery on page 33](#)).
  - b. Service door (see [Service door on page 34](#)).
  - c. Hard drive ([Hard drive on page 35](#))
  - d. Keyboard (see [Keyboard on page 42](#))

Remove the top cover:

1. Position the computer upside-down with the front toward you.

2. Remove the 2 large rubber screw covers on each side of the battery **(1)**, 1 rubber screw cover near the bottom, middle **(2)**, and 4 small rubber screw covers from the sides of the computer **(3)**.

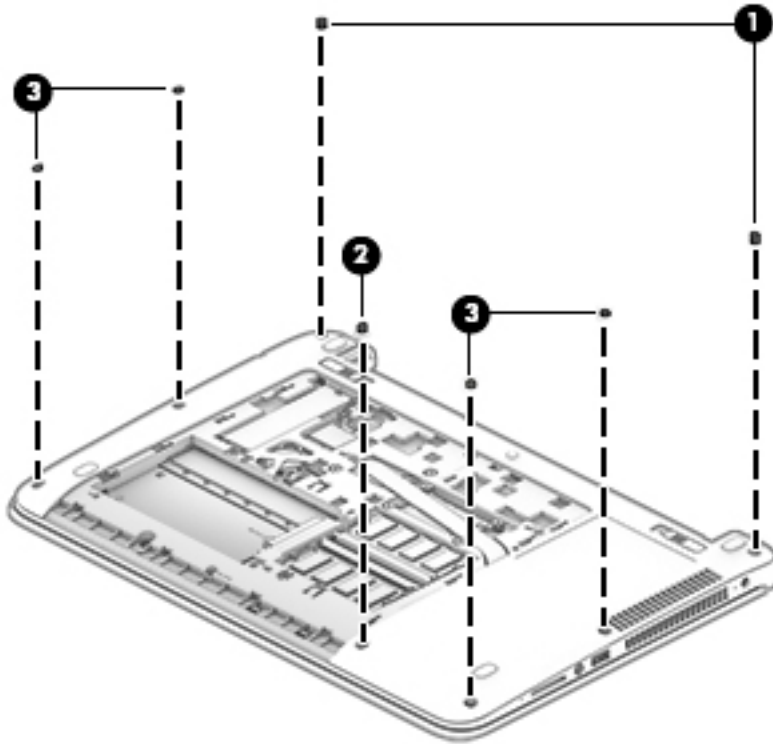

3. Remove the 8 Torx T8M2.5×6.0 screws **(1)** and the Phillips PM2.5×2.5 screw **(2)** that secures the top cover to the computer.

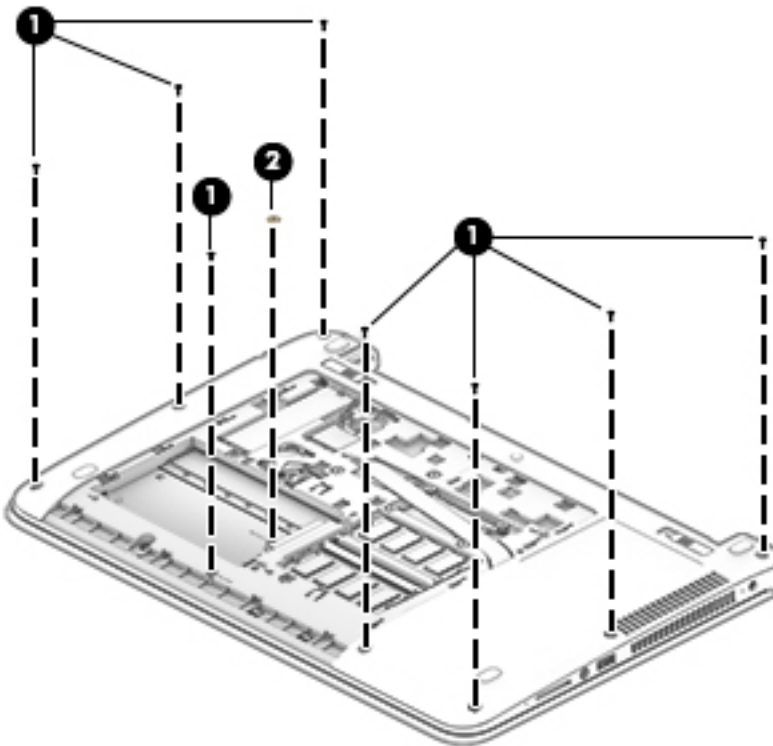

4. Position the computer upright and open it as far as possible.

5. Disconnect the following cables from the system board:

- **(1):** Fan cable
- **(2):** Function board cable
- **(3):** Fingerprint reader cable
- **(4):** Card reader board cable

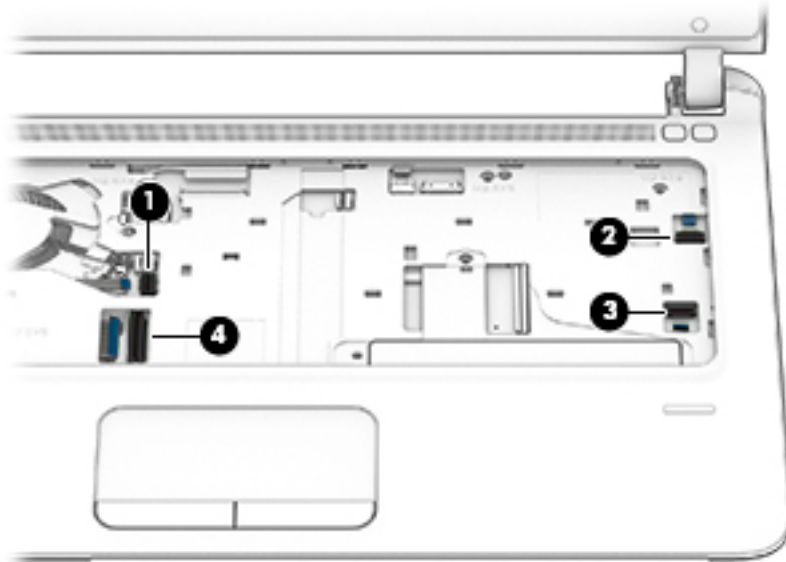

6. Remove the 5 Torx T8M2.5×6.0 screws from the top cover.

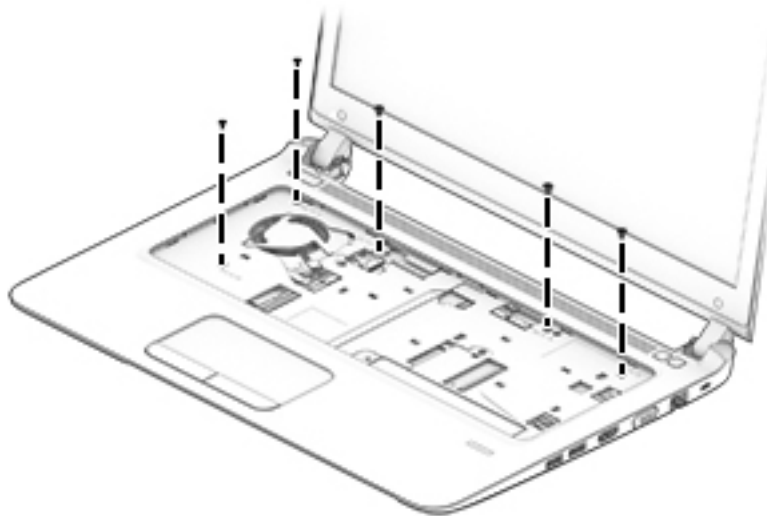

7. Pry the top cover off the computer starting at the top **(1)**, working around to the left side **(2)**, bottom **(3)**, and then right side **(4)**.

 **NOTE:** The top cover may be difficult to remove from the computer. Be careful not to damage the top cover when attempting to remove it.

---

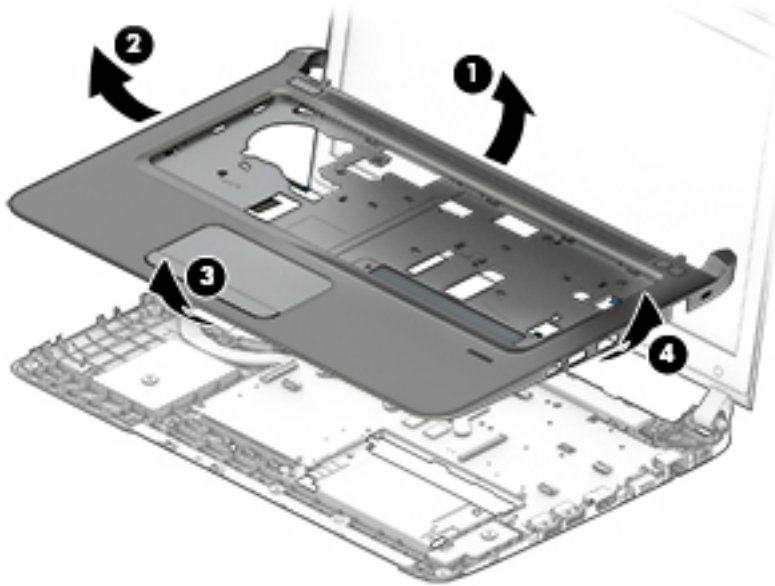

Reverse this procedure to install the top cover.

## Fingerprint reader assembly

Description	Spare part number
Fingerprint reader assembly (includes cable and bracket)	829011-001
Fingerprint reader insert (part of the Plastics Kit; for use in models without a fingerprint reader)	829013-001

Before removing the fingerprint reader assembly, follow these steps:

1. Shut down the computer. If you are unsure whether the computer is off or in Hibernation, turn the computer on, and then shut it down through the operating system.
2. Disconnect all external devices connected to the computer.
3. Disconnect the power from the computer by first unplugging the power cord from the AC outlet, and then unplugging the AC adapter from the computer.
4. Remove the battery (see [Battery on page 33](#)).
5. Remove the following components:
  - a. Service door (see [Service door on page 34](#)).
  - b. Keyboard (see [Keyboard on page 42](#))
  - c. Hard drive ([Hard drive on page 35](#))
  - d. Top cover (see [Top cover on page 47](#))

Remove the fingerprint reader assembly:

1. Position the top cover upside-down.
2. Slide the bracket out from under the clips **(1)** that secure it toward the side of the top cover **(2)**, and then lift it off the top cover **(3)**.

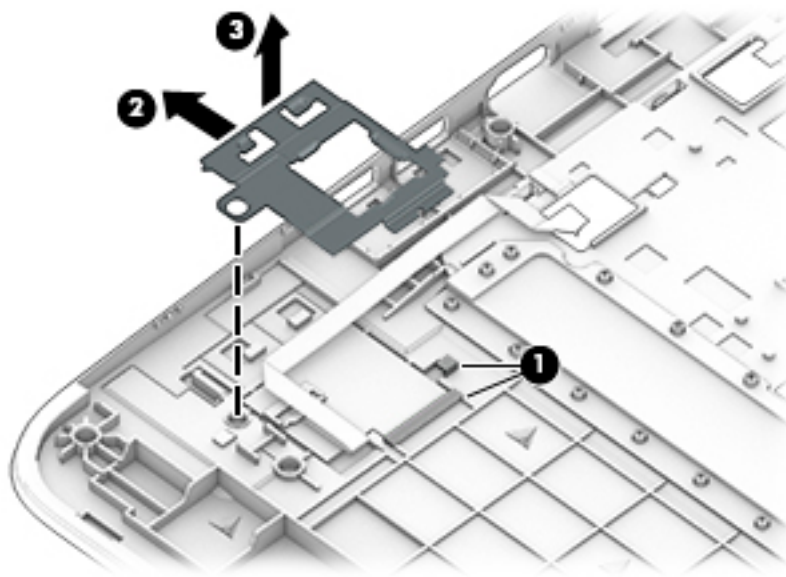

3. Lift the cable to disengage the adhesive that secures it (1), and then remove the fingerprint reader board and cable assembly from the top cover (2).

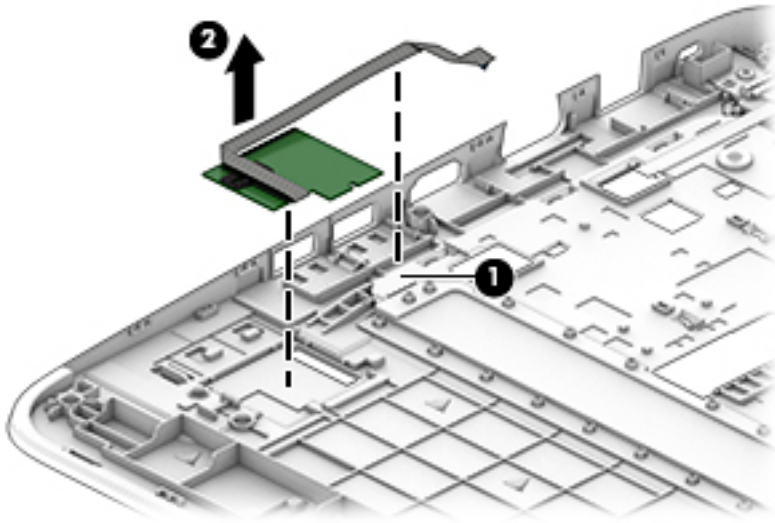

Reverse this procedure to install the fingerprint reader assembly.



## Power button board

Description	Spare part number
Power button board assembly	826387-001
Power button board cable (included in Cable Kit)	826399-001

Before removing the power button board, follow these steps:

1. Shut down the computer. If you are unsure whether the computer is off or in Hibernation, turn the computer on, and then shut it down through the operating system.
2. Disconnect all external devices connected to the computer.
3. Disconnect the power from the computer by first unplugging the power cord from the AC outlet, and then unplugging the AC adapter from the computer.
4. Remove the battery (see [Battery on page 33](#)).
5. Remove the following components:
  - a. Service door (see [Service door on page 34](#))
  - b. Hard drive ([Hard drive on page 35](#))
  - c. Keyboard (see [Keyboard on page 42](#))
  - d. Top cover (see [Top cover on page 47](#))

Remove the power button board:

1. Position the top cover upside-down.
2. Disconnect the cable from the board **(1)**.
3. Remove the Phillips PM2.0×3.0 screw **(2)** that secures the power button board to the top cover.
4. Lift left side of the board, and then slide board to left and out from under the tabs **(3)** to remove it.

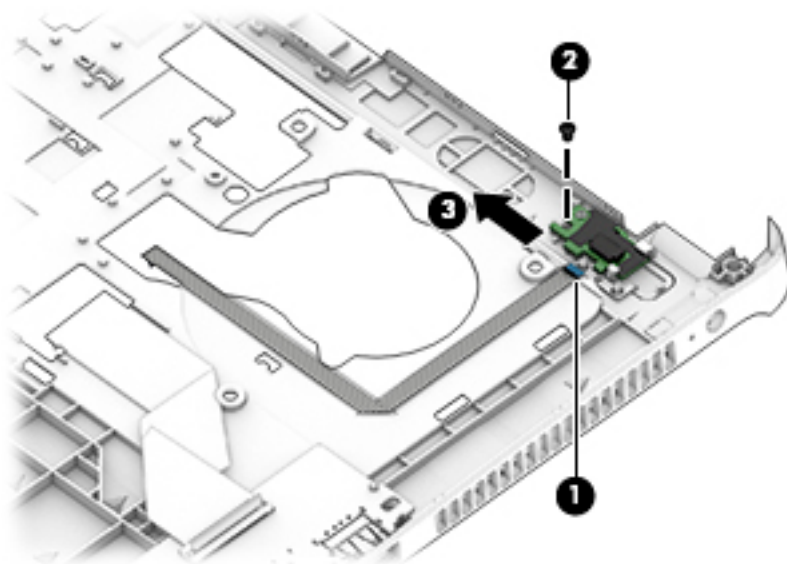

Reverse this procedure to install the power button board.

## Function board

Description	Spare part number
Function board	826381-001
Function board cable (included in Cable Kit)	826399-001

Before removing the function board, follow these steps:

1. Shut down the computer. If you are unsure whether the computer is off or in Hibernation, turn the computer on, and then shut it down through the operating system.
2. Disconnect all external devices connected to the computer.
3. Disconnect the power from the computer by first unplugging the power cord from the AC outlet, and then unplugging the AC adapter from the computer.
4. Remove the battery (see [Battery on page 33](#)).
5. Remove the following components:
  - a. Service door (see [Service door on page 34](#))
  - b. Hard drive ([Hard drive on page 35](#))
  - c. Keyboard (see [Keyboard on page 42](#))
  - d. Top cover (see [Top cover on page 47](#))

Remove the function board:

1. Position the top cover upside-down.
2. Disconnect the cable from the connector on the function board **(1)**.
3. Remove the Phillips PM2.0×3.0 screw **(2)** that secures the function board to the top cover.
4. Remove the board from the top cover **(3)**.

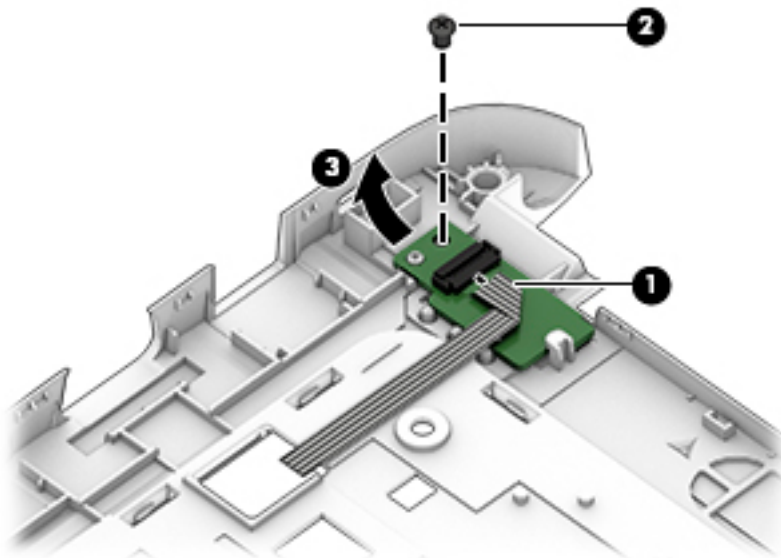

5. Remove the function board from the top cover.

Reverse this procedure to install the function board.

## USB/audio/card reader board

Description	Spare part number
USB/audio/card reader board	826374-001
USB/audio/card reader board cable (included in Cable Kit)	826399-001

Before removing the USB/audio/card reader board, follow these steps:

1. Shut down the computer. If you are unsure whether the computer is off or in Hibernation, turn the computer on, and then shut it down through the operating system.
2. Disconnect all external devices connected to the computer.
3. Disconnect the power from the computer by first unplugging the power cord from the AC outlet, and then unplugging the AC adapter from the computer.
4. Remove the battery (see [Battery on page 33](#)).
5. Remove the following components:
  - a. Service door (see [Service door on page 34](#)).
  - b. Hard drive ([Hard drive on page 35](#))
  - c. Keyboard (see [Keyboard on page 42](#))
  - d. Top cover (see [Top cover on page 47](#))

Remove the USB/audio/card reader board:



**NOTE:** Before you remove the card reader, make sure nothing (memory card or plastic insert) is installed.

1. Position the top cover upside-down.
2. Disconnect the large ribbon cable from the board **(1)**.
3. Disconnect the small touchpad ribbon cable from the board **(2)**.
4. Remove the Phillips PM2.5×5.0 screw **(3)** that secures the board to the computer.

5. Lift the rear of the board and pull it away from side of the top cover (4).

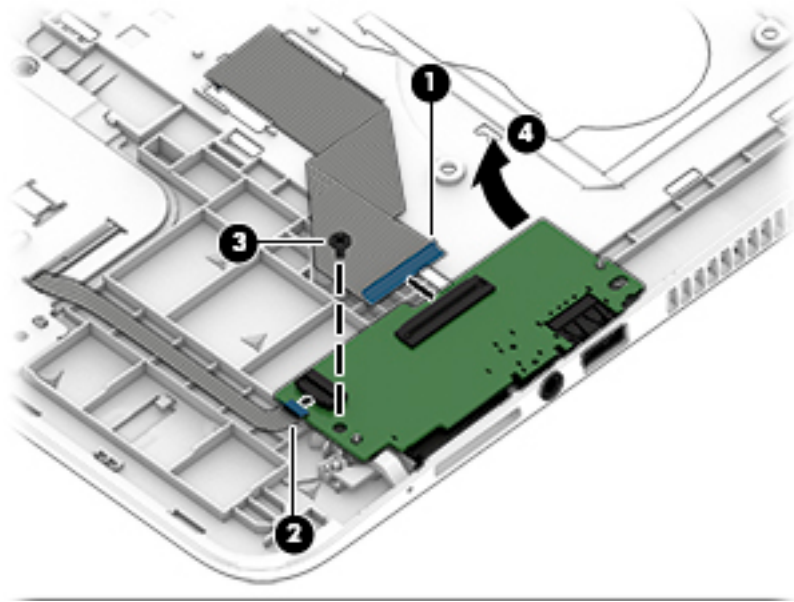

Reverse this procedure to install the USB/audio/card reader board.

## Fan

Description	Spare part number
Fan	829010-001



**NOTE:** To properly ventilate the computer, allow at least **7.6 cm** (3.0 in) of clearance on the left side of the computer. The computer uses an electric fan for ventilation. The fan is controlled by a temperature sensor and is designed to turn on automatically when high temperature conditions exist. These conditions are affected by high external temperatures, system power consumption, power management/battery conservation configurations, battery fast charging, and software requirements. Exhaust air is displaced through the ventilation grill located on the left side of the computer.

Before removing the fan/heat sink assembly, follow these steps:

1. Shut down the computer. If you are unsure whether the computer is off or in Hibernation, turn the computer on, and then shut it down through the operating system.
2. Disconnect all external devices connected to the computer.
3. Disconnect the power from the computer by first unplugging the power cord from the AC outlet and then unplugging the AC adapter from the computer.
4. Remove the battery (see [Battery on page 33](#)), and then remove the following components:
  - a. Service door (see [Service door on page 34](#)).
  - b. Hard drive ([Hard drive on page 35](#))
  - c. Keyboard (see [Keyboard on page 42](#))
  - d. Top cover (see [Top cover on page 47](#))

To remove the fan:

1. Disconnect the fan cable **(1)** from the system board.
2. Remove the Phillips PM2.5×5.0 screw **(2)** that secures the fan to the computer.

3. Lift the fan from the computer (3).

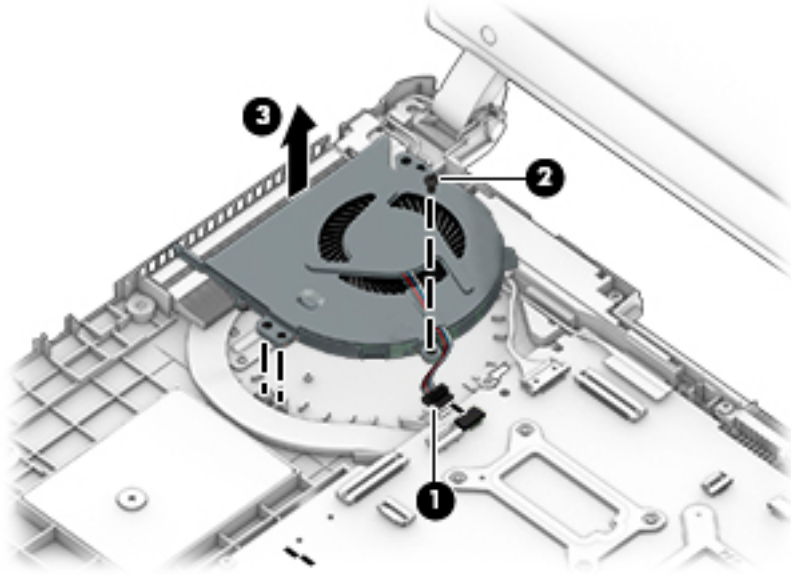

Reverse this procedure to install the fan.

## Battery connector cable

The battery connector cable is included in the Cable Kit, spare part number 826399-001.

Before removing the battery connector cable, follow these steps:

1. Shut down the computer. If you are unsure whether the computer is off or in Hibernation, turn the computer on, and then shut it down through the operating system.
2. Disconnect all external devices connected to the computer.
3. Disconnect the power from the computer by first unplugging the power cord from the AC outlet, and then unplugging the AC adapter from the computer.
4. Remove the battery (see [Battery on page 33](#)).
5. Remove the following components:
  - a. Service door (see [Service door on page 34](#)).
  - b. Hard drive ([Hard drive on page 35](#))
  - c. Keyboard (see [Keyboard on page 42](#))
  - d. Top cover (see [Top cover on page 47](#))

Remove the battery connector cable:

1. Disconnect the battery connector cable from the system board **(1)**.
2. Remove the cable from the clip in the computer **(2)**.
3. Remove the 2 Phillips PM2.5×5.0 screws that secure the battery connector cable to the computer **(3)**.
4. Remove the battery connector cable from the computer **(4)**.

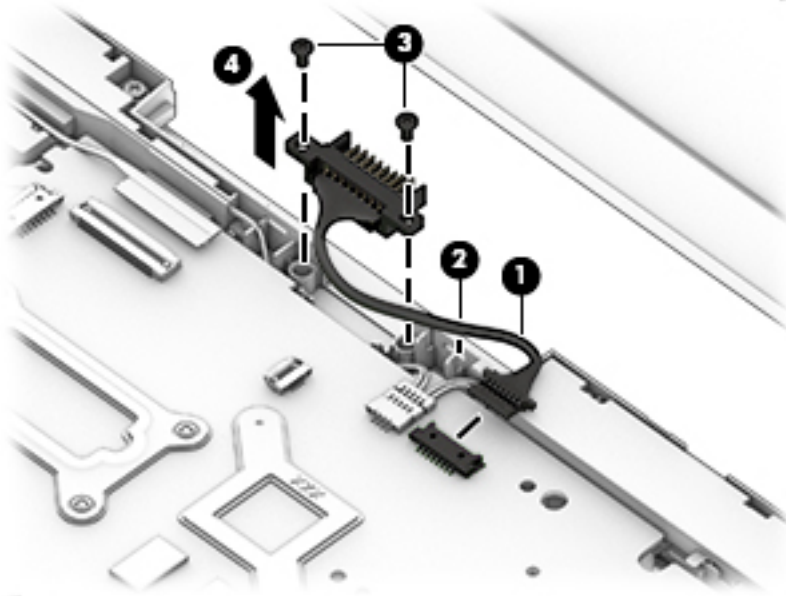

Reverse this procedure to install the battery connector cable.

## System board



**NOTE:** All system board spare part kits include replacement thermal material.

All system boards use the following part numbers:

xxxxxx-001: Windows 7 or non-Windows operating systems

xxxxxx-601: Windows 8.1 or Windows 10 operating system

Description	Spare part number
<b>System board with processor:</b>	
Intel Core i7-6500U processor; 2-GB discrete graphics memory	830947-xxx
Intel Core i5-6300U processor; 2-GB discrete graphics memory	830946-xxx
Intel Core i5-6200U processor; 2-GB discrete graphics memory	830945-xxx
Intel Core i3-6100U processor; 2-GB discrete graphics memory	830944-xxx
Intel Core i3-6100U processor; 1-GB discrete graphics memory	830943-xxx
Intel Core i7-6500U processor; UMA graphics memory	830940-xxx
Intel Core i5-6300U processor; UMA graphics memory	830939-xxx
Intel Core i5-6200U processor; UMA graphics memory	830937-xxx
Intel Core i3-6100U processor; UMA graphics memory	830935-xxx
Intel Pentium 4405U processor; UMA graphics memory	830942-xxx
Intel Celeron 3855U processor; UMA graphics memory	830934-xxx

Before removing the system board, follow these steps:

1. Shut down the computer. If you are unsure whether the computer is off or in Hibernation, turn the computer on, and then shut it down through the operating system.
2. Disconnect all external devices connected to the computer.
3. Disconnect the power from the computer by first unplugging the power cord from the AC outlet, and then unplugging the AC adapter from the computer.
4. Remove the battery (see [Battery on page 33](#)).
5. Remove the following components:
  - a. Service door (see [Service door on page 34](#)).
  - b. Hard drive (see [Hard drive on page 35](#))
  - c. Keyboard (see [Keyboard on page 42](#))
  - d. Top cover (see [Top cover on page 47](#))

When replacing the system board, be sure to remove the following components from the defective system board and install on the replacement system board:

- Memory modules (see [Memory modules on page 37](#))
- WLAN/Bluetooth module (see [WLAN/Bluetooth combo card on page 39](#))



- M.2 solid-state drive (see [M.2 solid-state drive on page 41](#))
- Heat sink (see [Heat sink assembly on page 66](#))

Remove the system board:

1. Position the computer upright with the front toward you.
2. Disconnect the following cables from the system board:
  - (1) Power connector cable
  - (2) Display cable
  - (3) Speaker cable
  - (4) Battery connector cable

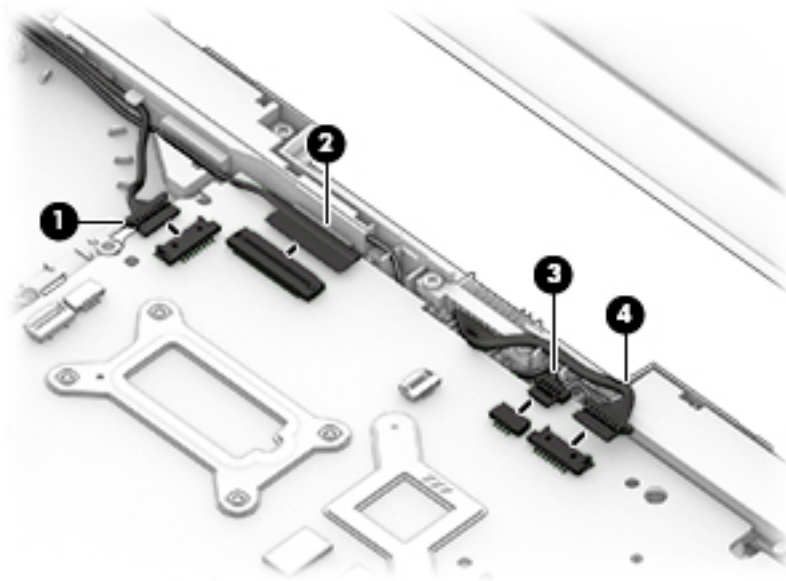

3. Remove the 4 Phillips PM2.5×5.0 screws (1) that secure the system board to the computer.

4. Lift the left side of the system board up at an angle, and then remove the system board from the computer (2).

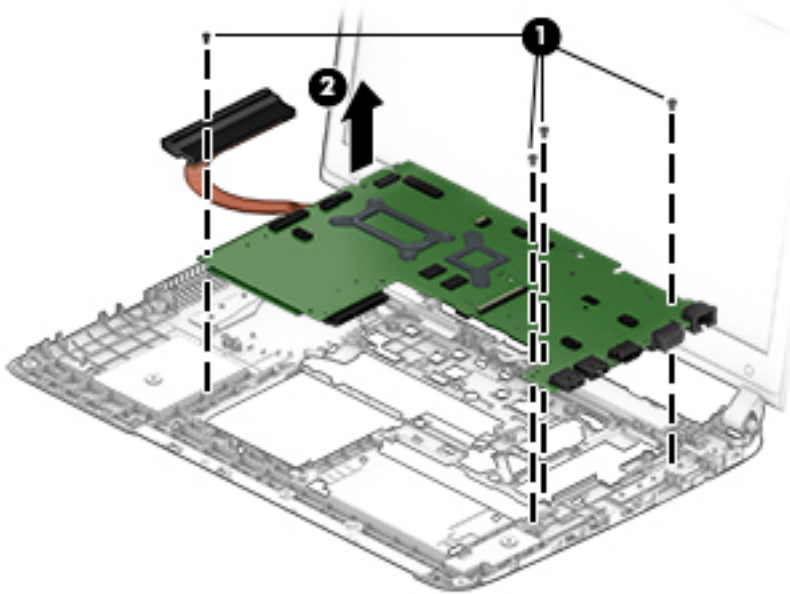

Reverse this procedure to install the system board.

## RTC battery

Description	Spare part number
RTC battery	826388-001

Before removing the RTC battery, follow these steps:

1. Shut down the computer. If you are unsure whether the computer is off or in Hibernation, turn the computer on, and then shut it down through the operating system.
2. Disconnect all external devices connected to the computer.
3. Disconnect the power from the computer by first unplugging the power cord from the AC outlet, and then unplugging the AC adapter from the computer.
4. Remove the battery (see [Battery on page 33](#)).
5. Remove the following components:
  - a. Service door (see [Service door on page 34](#)).
  - b. Hard drive (see [Hard drive on page 35](#))
  - c. Keyboard (see [Keyboard on page 42](#))
  - d. Top cover (see [Top cover on page 47](#))
  - e. System board (see [System board on page 60](#))

Remove the RTC battery:

1. Position the system board upside-down.
2. Use a tool to pry the battery out of the socket **(1)**.
3. Remove the battery from the system board **(2)**.

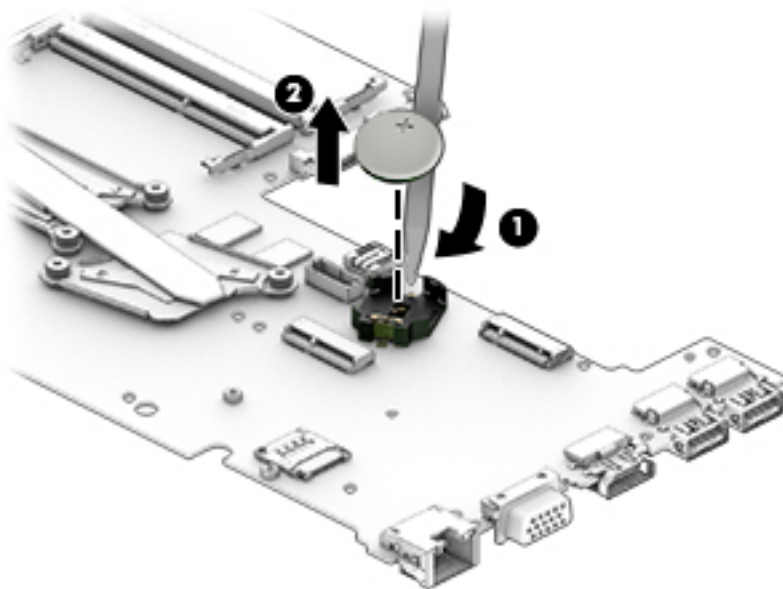

Reverse this procedure to install the RTC battery.

## Speaker assembly

Description	Spare part number
Speaker assembly	829014-001

Before removing the speaker assembly, follow these steps:

1. Shut down the computer. If you are unsure whether the computer is off or in Hibernation, turn the computer on, and then shut it down through the operating system.
2. Disconnect all external devices connected to the computer.
3. Disconnect the power from the computer by first unplugging the power cord from the AC outlet, and then unplugging the AC adapter from the computer.
4. Remove the battery (see [Battery on page 33](#)).
5. Remove the following components:
  - a. Service doors (see [Service door on page 34](#)).
  - b. Keyboard (see [Keyboard on page 42](#))
  - c. Hard drive ([Hard drive on page 35](#))
  - d. Top cover (see [Top cover on page 47](#))
  - e. System board (see [System board on page 60](#))

Remove the speaker assembly:

1. Position the computer upright.
2. Remove the 2 Phillips PM2.0×5.0 screws **(1)** that secure the speakers to the computer.
3. Remove the speaker wire from the routing clips in the chassis **(2)**.

4. Remove the speakers from the top cover (3).

 **NOTE:** When reinstalling the speakers, make sure the rubber gaskets in each screw hole (4) are correctly in place.

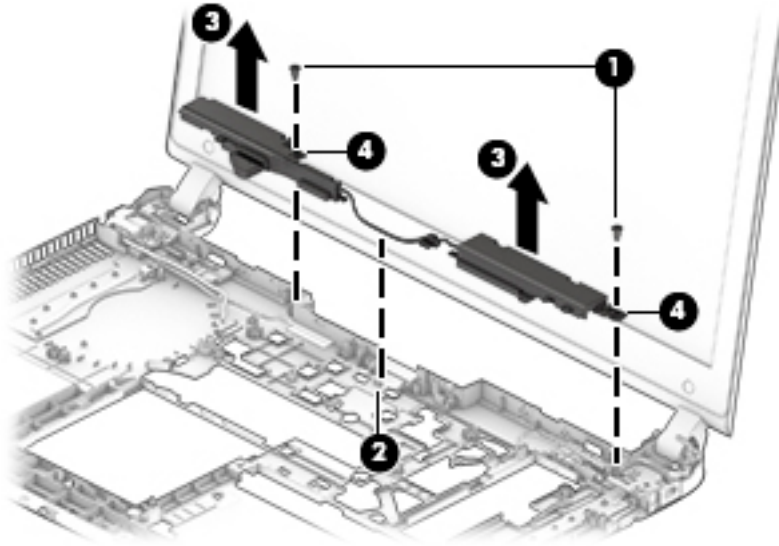

Reverse this procedure to install the speaker assembly.

## Heat sink assembly

All heat sink assembly spare part kits include replacement thermal material.

Description	Spare part number
Heat sink for use in models with discrete graphics	826404-001
Heat sink for use in models with UMA graphics	829012-001

Before removing the heat sink assembly, follow these steps:

1. Shut down the computer. If you are unsure whether the computer is off or in Hibernation, turn the computer on, and then shut it down through the operating system.
2. Disconnect all external devices connected to the computer.
3. Disconnect the power from the computer by first unplugging the power cord from the AC outlet, and then unplugging the AC adapter from the computer.
4. Remove the battery (see [Battery on page 33](#)).
5. Remove the following components:
  - a. Service door (see [Service door on page 34](#)).
  - b. Hard drive (see [Hard drive on page 35](#))
  - c. WLAN module (see [WLAN/Bluetooth combo card on page 39](#))
  - d. Keyboard (see [Keyboard on page 42](#))
  - e. Top cover (see [Top cover on page 47](#))
  - f. System board (see [System board on page 60](#))

Remove the heat sink assembly:

1. Position the system board upside-down.
2. Models are available with either UMA or discrete graphics. The heat sink on discrete models includes 2 additional screws. Refer to the following steps that match your model:

**Discrete models:**

  - a. To remove the discrete heat sink assembly, in the order indicated on the heat sink, loosen the 6 captive Phillips screws **(1)–(6)** that secure the heat sink to the system board.

- b. Lift the heat sink from the system board (7).

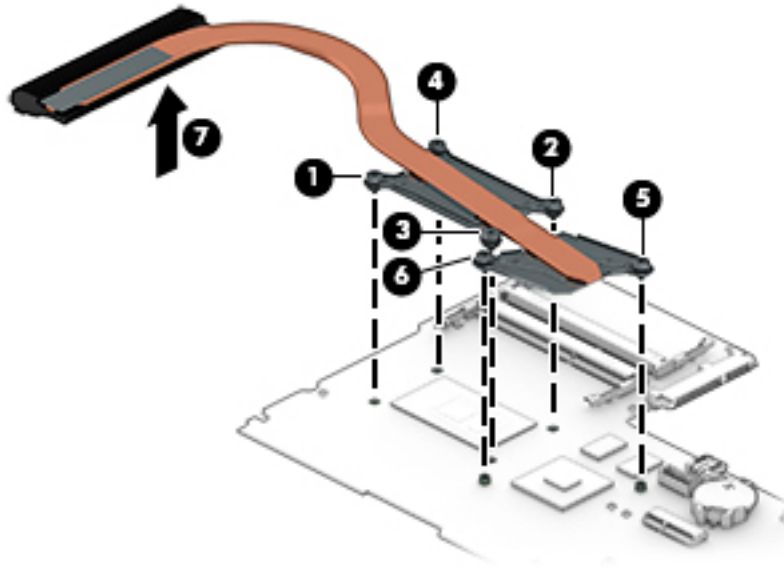

 **NOTE:** For discrete models, thoroughly clean thermal material from the surfaces of the system board components (1)(3) and the heat sink (2)(4) each time you remove the heat sink. All heat sink and processor spare part kits include thermal material.

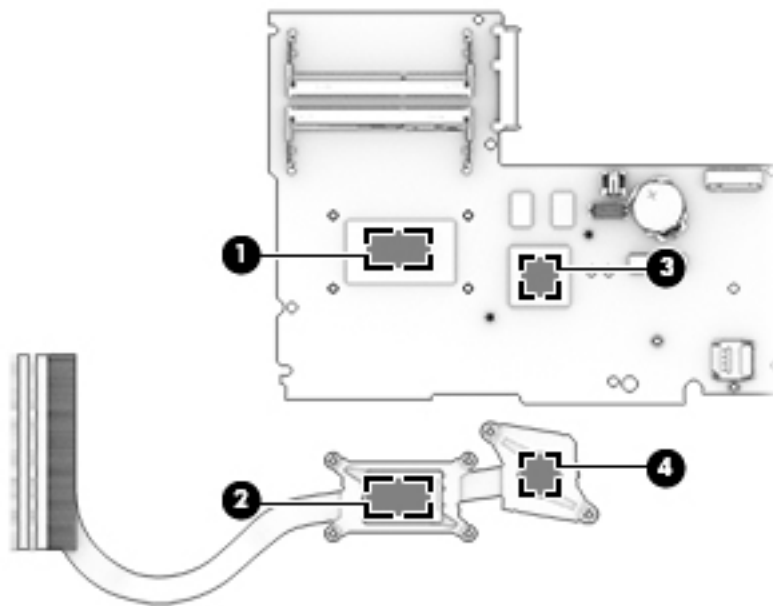

**UMA models:**

- a. To remove the UMA heat sink assembly, in the order indicated on the heat sink, loosen the 4 captive Phillips screws (1)–(4) that secure the heat sink to the system board.

- b. Lift the heat sink from the system board (5).

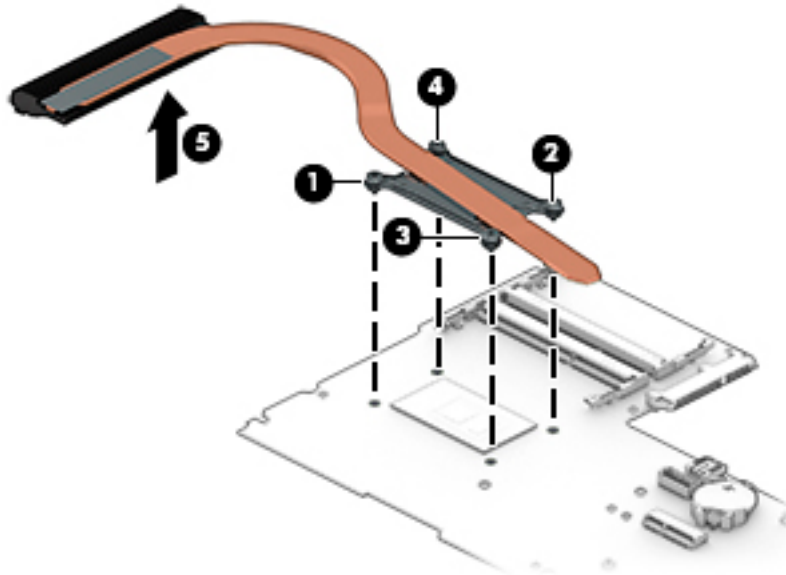

 **NOTE:** For UMA models, thoroughly clean thermal material from the surfaces of the system board component (1) and the heat sink (2) each time you remove the heat sink. All heat sink and processor spare part kits include thermal material.

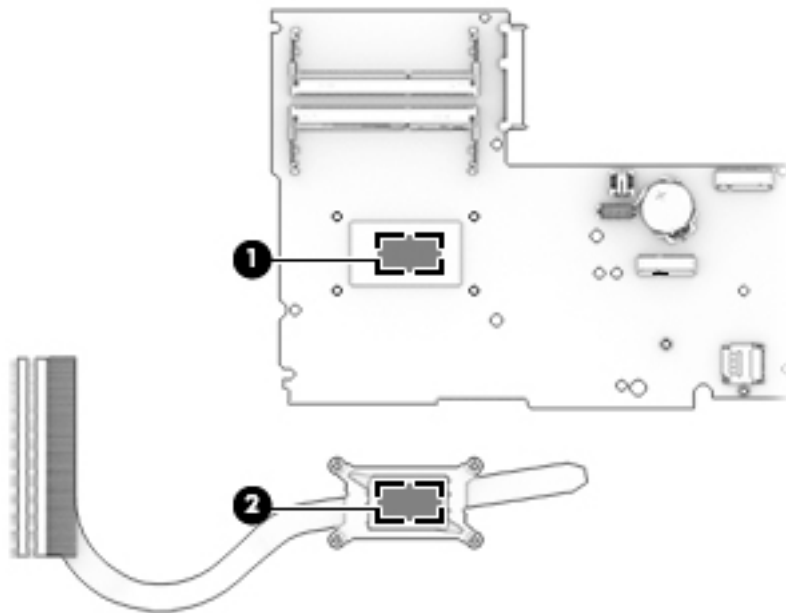

Reverse this procedure to install the heat sink assembly.



## Display assembly

Description	Spare part number
Display panel assembly, touch screen	826400-001
Display panel assembly, touch screen, two antennas	826401-001

Before removing the display assembly, follow these steps:

1. Shut down the computer. If you are unsure whether the computer is off or in Hibernation, turn the computer on, and then shut it down through the operating system.
2. Disconnect all external devices connected to the computer.
3. Disconnect the power from the computer by first unplugging the power cord from the AC outlet, and then unplugging the AC adapter from the computer.
4. Remove the battery (see [Battery on page 33](#)).
5. Remove the following components:
  - a. Service door (see [Service door on page 34](#)).
  - b. Hard drive (see [Hard drive on page 35](#))
  - c. WLAN module (see [WLAN/Bluetooth combo card on page 39](#))
  - d. Keyboard (see [Keyboard on page 42](#))
  - e. Top cover (see [Top cover on page 47](#))

Remove the display assembly:

1. Position the computer upright and open.
2. Disconnect the display cable from the system board **(1)**.
3. Pull the WLAN antennas through the hole in the computer **(2)**, and then remove them from the routing path near the right display hinge **(3)**.

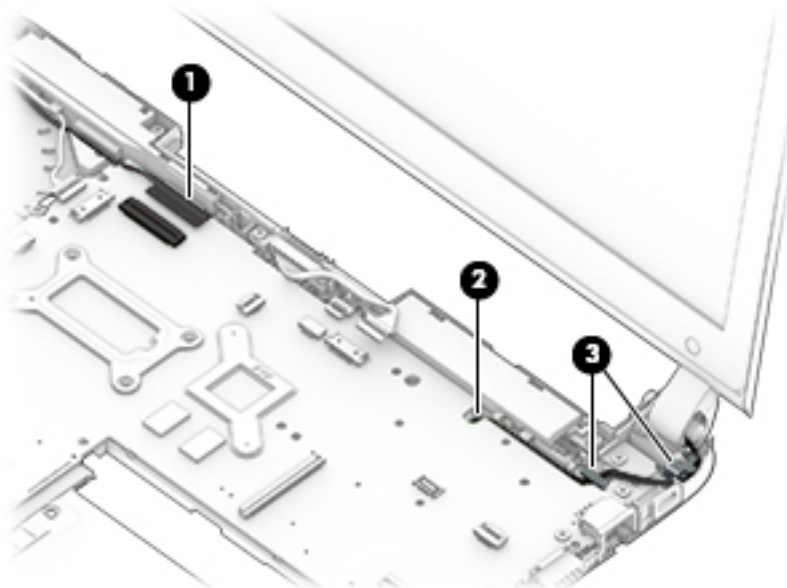

4. Remove the 4 Phillips PM2.5×5.0 screws **(1)** from the display hinges.
5. Lift the display assembly straight up and remove it **(2)**.

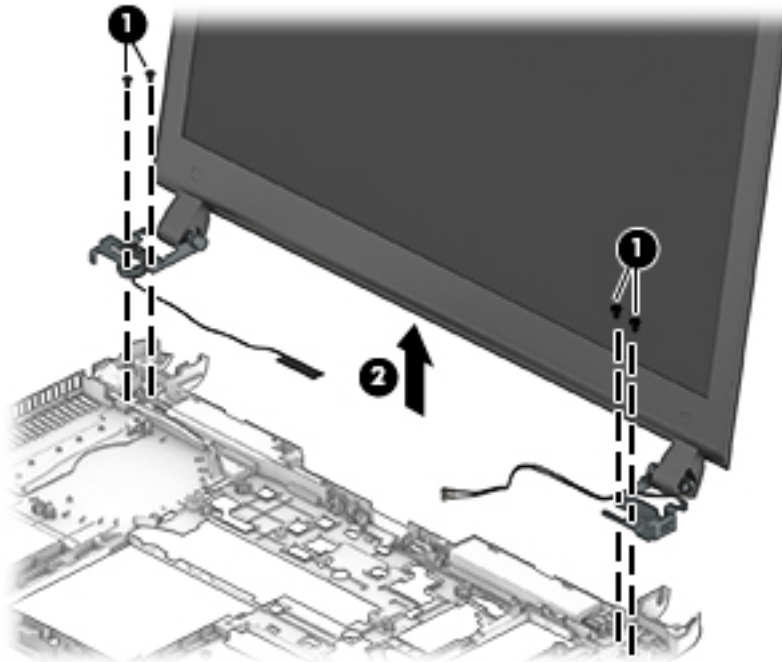

**⚠ CAUTION:** When installing the display assembly, be sure that the wireless antenna cables are routed and arranged properly.  
Failure to properly route the antennas can result in degradation of the computer's wireless performance.

6. To remove the display bezel, remove the 2 screw covers **(1)** and the 2 Phillips PM2.0×4.0 screws **(2)** from the bottom corners of the display bezel.

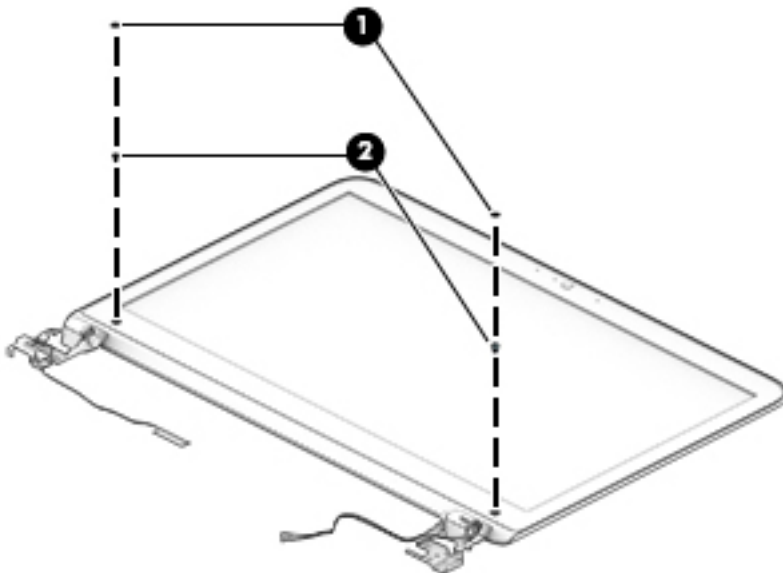

7. Flex the top **(1)** of the bezel, the inside edges of the left and right sides **(2)**, and then the bottom **(3)** of the bezel until it disengages from the display enclosure.

**8. Remove the display bezel (4).**

The display bezel is available using spare part number 826397-001 for models with a webcam and 826398-001 for models without a webcam. Display bezel mylar screw covers are available in the Rubber Kit, spare part number 826407-001.

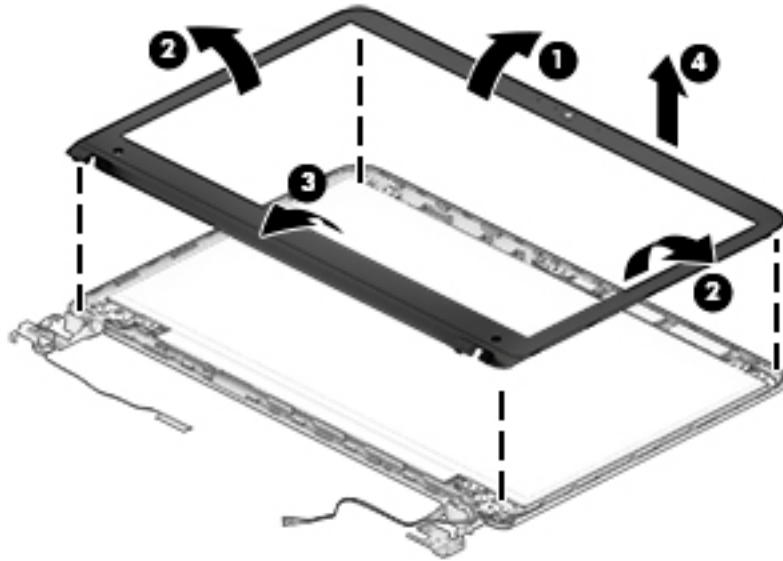

**9. If it is necessary to replace the webcam or microphone module, disconnect the cable from the module (1), and then gently pull the module away from the double-sided tape on the display enclosure (2).**

The webcam module is available using spare part number 826395-001. The microphone module is available using spare part number 826385-001.

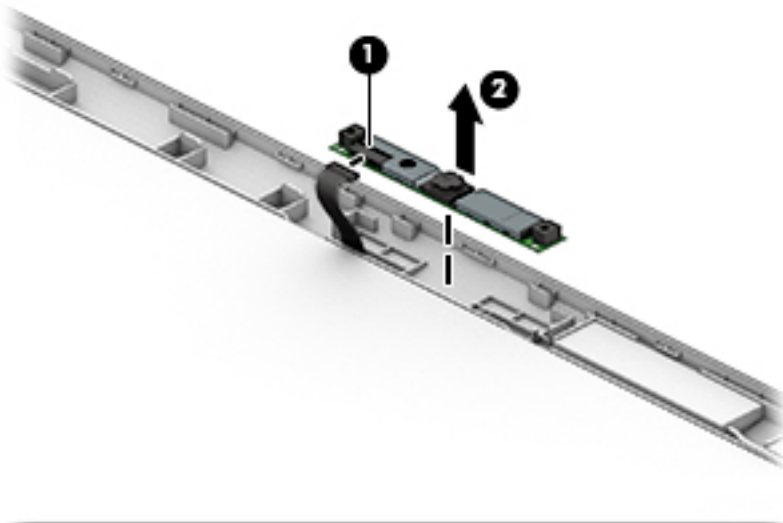

10. If it is necessary to remove the display panel from the enclosure, remove the 4 Phillips PM2.0×4.0 screws that secure the panel to the display enclosure.

The raw display panel is available using spare part number 826402-001 for FHD panels and 826403-001 for HD panels.

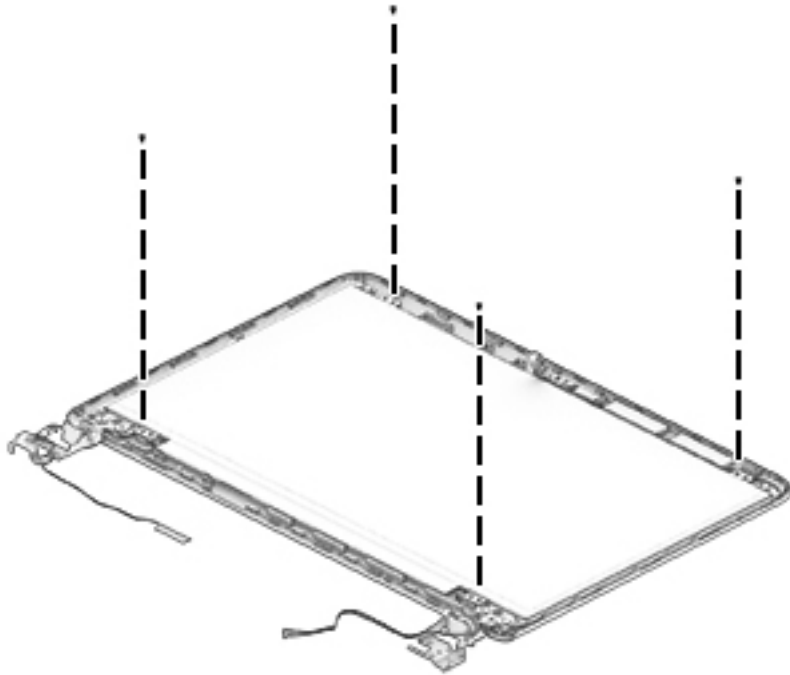

11. Rotate the display panel all the way over (1), disconnect the display cable from the rear of the panel (2), and then remove the display panel (3) from the enclosure.

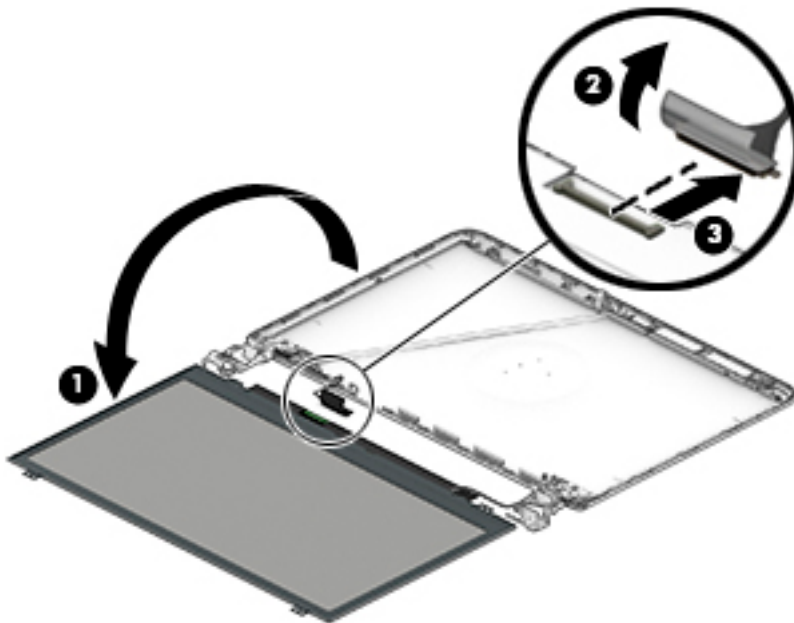

12. If it is necessary to replace the display hinges, remove the 2 Phillips PM2.0×3.0 screws at the top (1) and the 4 broadhead Phillips PM2.5×3.0 screws at the bottom (2) that secure the display hinges to the display enclosure.

13. Remove the display hinges from the display enclosure (3).

Display hinges are available in the Display Hinge Kit using spare part number 826405-001.

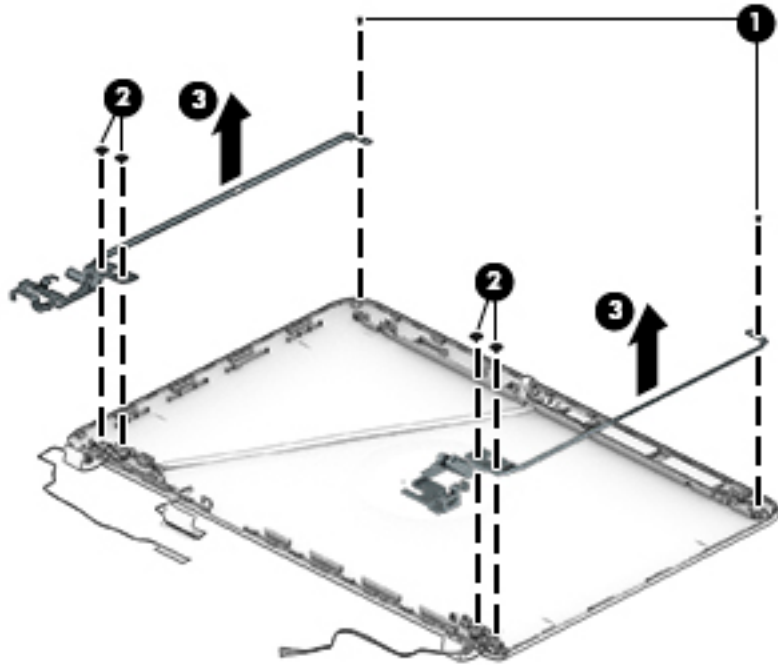

14. If it is necessary to replace the display/webcam cable, remove the cable from the clips on the display enclosure (1), and then lift the cable straight up and off the display panel (2).

The display/webcam cable is available in the Cable Kit using spare part number 826399-001.

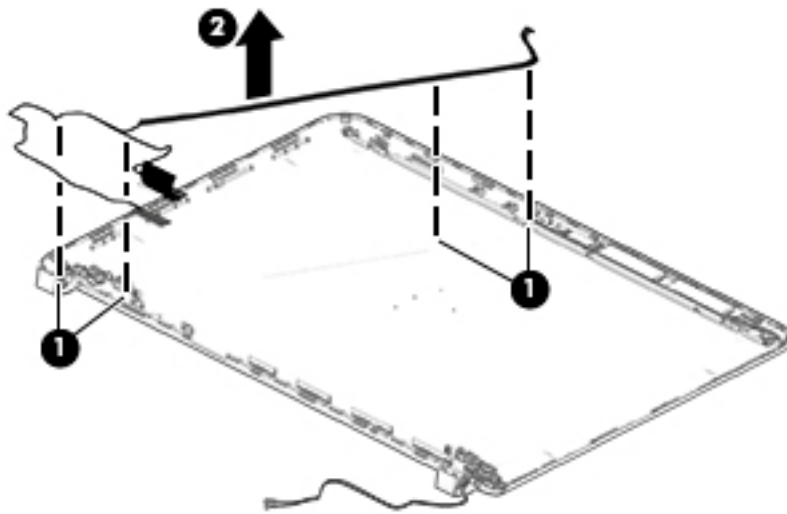

Reverse this procedure to reassemble and install the display assembly.

## Power connector and cable

Description	Spare part number
Power connector and cable	827039-001

Before removing the power cable, follow these steps:

1. Shut down the computer. If you are unsure whether the computer is off or in Hibernation, turn the computer on, and then shut it down through the operating system.
2. Disconnect all external devices connected to the computer.
3. Disconnect the power from the computer by first unplugging the power cord from the AC outlet, and then unplugging the AC adapter from the computer.
4. Remove the battery (see [Battery on page 33](#)).
5. Remove the following components:
  - a. Service door (see [Service door on page 34](#)).
  - b. Keyboard (see [Keyboard on page 42](#))
  - c. Hard drive ([Hard drive on page 35](#))
  - d. Top cover (see [Top cover on page 47](#))
  - e. Display assembly (see [Display assembly on page 69](#))

Remove the power cable:

1. Disconnect the cable from the system board **(1)**.
2. Remove the cable from the clips around the fan **(2)**, and then lift the power cable from the computer **(3)**.

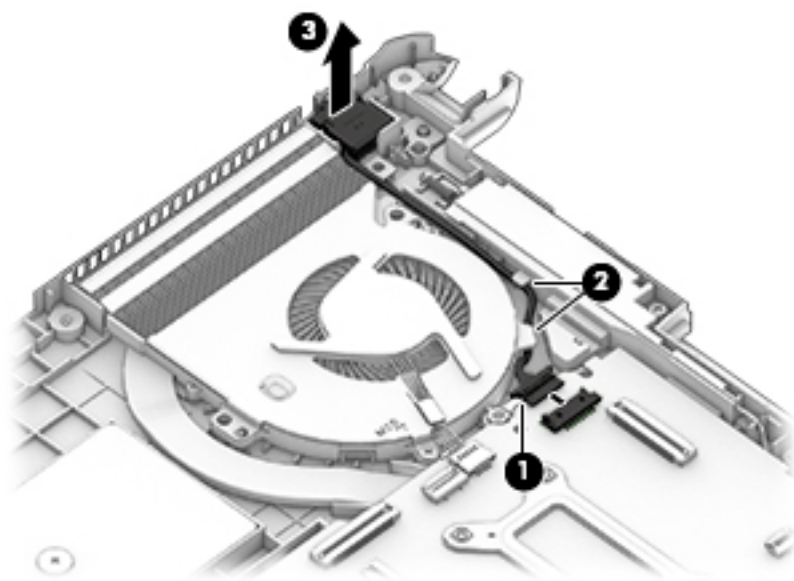

Reverse this procedure to install the power cable.

---

# 7 Computer Setup (BIOS) and MultiBoot in Windows 7

## Using Computer Setup

Computer Setup, or Basic Input/Output System (BIOS), controls communication between all the input and output devices on the system (such as disk drives, display, keyboard, mouse, and printer). Computer Setup includes settings for the types of devices installed, the startup sequence of the computer, and the amount of system and extended memory.

---

 **NOTE:** Use extreme care when making changes in Computer Setup. Errors can prevent the computer from operating properly.

---

## Starting Computer Setup

---

 **NOTE:** An external keyboard or mouse connected to a USB port can be used with Computer Setup only if USB legacy support is enabled.

---

To start Computer Setup, follow these steps:

1. Turn on or restart the computer, and then press **esc** while the “Press the ESC key for Startup Menu” message is displayed at the bottom of the screen.
2. Press **f10** to enter Computer Setup.

## Navigating and selecting in Computer Setup

To navigate and select in Computer Setup, follow these steps:

1. Turn on or restart the computer, and then press **esc** while the “Press the ESC key for Startup Menu” message is displayed at the bottom of the screen.

---

 **NOTE:** You can use either a pointing device (TouchPad, pointing stick, or USB mouse) or the keyboard to navigate and make selections in Computer Setup.

---

2. Press **f10** to enter Computer Setup.
  - To select a menu or a menu item, use the **tab** key and the keyboard arrow keys and then press **enter**, or use a pointing device to click the item.
  - To scroll up and down, click the up arrow or the down arrow in the upper-right corner of the screen, or use the up arrow key or the down arrow key on the keyboard.
  - To close open dialog boxes and return to the main Computer Setup screen, press **esc**, and then follow the on-screen instructions.

To exit Computer Setup menus, choose one of the following methods:

- To exit Computer Setup menus without saving your changes:  
Click the **Exit** icon in the lower-right corner of the screen, and then follow the on-screen instructions.

– or –

Use the arrow keys to select **Main > Ignore Changes and Exit**, and then press [enter](#).

- To save your changes and exit Computer Setup menus:

Click the **Save** icon in the lower-right corner of the screen, and then follow the on-screen instructions.

– or –

Use the arrow keys to select **Main > Save Changes and Exit**, and then press [enter](#).

Your changes go into effect when the computer restarts.

## Restoring factory settings in Computer Setup



**NOTE:** Restoring defaults will not change the hard drive mode.

To return all settings in Computer Setup to the values that were set at the factory, follow these steps:

1. Turn on or restart the computer, and then press [esc](#) while the “Press the ESC key for Startup Menu” message is displayed at the bottom of the screen.
2. Press [f10](#) to enter Computer Setup.
3. Use a pointing device or the arrow keys to select **Main > Restore Defaults**.
4. Follow the on-screen instructions.
5. To save your changes and exit, click the **Save** icon in the lower-right corner of the screen, and then follow the on-screen instructions.

– or –

Use the arrow keys to select **Main > Save Changes and Exit**, and then press [enter](#).

Your changes go into effect when the computer restarts.



**NOTE:** Your password settings and security settings are not changed when you restore the factory settings.

## Updating the BIOS

Updated versions of the BIOS may be available on the HP website.

Most BIOS updates on the HP website are packaged in compressed files called *SoftPaqs*.

Some download packages contain a file named *Readme.txt*, which contains information regarding installing and troubleshooting the file.

## Determining the BIOS version

To determine whether available BIOS updates contain later BIOS versions than those currently installed on the computer, you need to know the version of the system BIOS currently installed.

BIOS version information (also known as *ROM date* and *System BIOS*) can be revealed by pressing [fn+esc](#) (if you are already in Windows) or by using Computer Setup.

1. Start Computer Setup.
2. Use a pointing device or the arrow keys to select **Main > System Information**.
3. To exit Computer Setup without saving your changes, click the **Exit** icon in the lower-right corner of the screen, and then follow the on-screen instructions.

– or –



Use the arrow keys to select **Main > Ignore Changes and Exit**, and then press **enter**.

## Downloading a BIOS update

 **CAUTION:** To reduce the risk of damage to the computer or an unsuccessful installation, download and install a BIOS update only when the computer is connected to reliable external power using the AC adapter. Do not download or install a BIOS update while the computer is running on battery power, docked in an optional docking device, or connected to an optional power source. During the download and installation, follow these instructions:

Do not disconnect power on the computer by unplugging the power cord from the AC outlet.

Do not shut down the computer or initiate Sleep.

Do not insert, remove, connect, or disconnect any device, cable, or cord.

1. Access Help and Support by selecting **Start > All Programs > HP Help and Support > HP Support Assistant**.
2. Select **Updates and tune-ups**, and then select **Check for HP updates now**.
3. At the download area, follow these steps:
  - a. Identify the most recent BIOS update and compare it to the BIOS version currently installed on your computer. Make a note of the date, name, or other identifier. You may need this information to locate the update later, after it has been downloaded to your hard drive.
  - b. Follow the on-screen instructions to download your selection to the hard drive.

If the update is more recent than your BIOS, make a note of the path to the location on your hard drive where the BIOS update is downloaded. You will need to access this path when you are ready to install the update.

 **NOTE:** If you connect your computer to a network, consult the network administrator before installing any software updates, especially system BIOS updates.

BIOS installation procedures vary. Follow any instructions that are revealed on the screen after the download is complete. If no instructions are revealed, follow these steps:

1. Select **Start > Computer**.
2. Click your hard drive designation. The hard drive designation is typically Local Disk (C:).
3. Using the hard drive path you recorded earlier, open the folder on your hard drive that contains the update.
4. Double-click the file that has an .exe extension (for example, *filename.exe*).  
The BIOS installation begins.
5. Complete the installation by following the on-screen instructions.

 **NOTE:** After a message on the screen reports a successful installation, you can delete the downloaded file from your hard drive.

## Using MultiBoot

### About the boot device order

As the computer starts, the system attempts to boot from enabled devices. The MultiBoot utility, which is enabled at the factory, controls the order in which the system selects a boot device. Boot devices can include

optical drives, diskette drives, a network interface card (NIC), hard drives, and USB devices. Boot devices contain bootable media or files that the computer needs to start and operate properly.



**NOTE:** Some boot devices must be enabled in Computer Setup before they can be included in the boot order.

You can change the order in which the computer searches for a boot device by changing the boot order in Computer Setup. You can also press **esc** while the “Press the ESC key for Startup Menu” message is displayed at the bottom of the screen, and then press **f9**. Pressing **f9** displays a menu that shows the current boot devices and allows you to select a boot device. Or, you can use MultiBoot Express to set the computer to prompt you for a boot location each time the computer turns on or restarts.

## Choosing MultiBoot preferences

You can use MultiBoot in the following ways:

- To set a new boot order that the computer uses each time it is turned on, by changing the boot order in Computer Setup.
- To dynamically choose the boot device, by pressing **esc** while the “Press the ESC key for Startup Menu” message is displayed at the bottom of the screen, and then pressing **f9** to enter the Boot Device Options menu.
- To use MultiBoot Express to set variable boot orders. This feature prompts you for a boot device each time the computer is turned on or restarted.

## Setting a new boot order in Computer Setup

To start Computer Setup and set a boot device order that the computer uses each time it is turned on or restarted, follow these steps:

1. Turn on or restart the computer, and then press **esc** while the “Press the ESC key for Startup Menu” message is displayed at the bottom of the screen.
2. Press **f10** to enter Computer Setup.
3. Use a pointing device or the arrow keys to select the **Legacy Boot Order** list, and then press **enter**.
4. To move the device up in the boot order, use a pointing device to click the up arrow, or press the **+** key.  
– or –  
To move the device down in the boot order, use a pointing device to click the down arrow, or press the **-** key.
5. To save your changes and exit Computer Setup, click the **Save** icon in the lower-left corner of the screen, and then follow the on-screen instructions.  
– or –  
Use the arrow keys to select **Main > Save Changes and Exit**, and then press **enter**.

## Dynamically choosing a boot device using the f9 prompt

To dynamically choose a boot device for the current startup sequence, follow these steps:

1. Open the Select Boot Device menu by turning on or restarting the computer, and then pressing **esc** while the “Press the ESC key for Startup Menu” message is displayed at the bottom of the screen.
2. Press **f9**.
3. Use a pointing device or the arrow keys to select a boot device, then press **enter**.

## Setting a MultiBoot Express prompt

To start Computer Setup and set the computer to display the MultiBoot startup location menu each time the computer is started or restarted, follow these steps:

1. Turn on or restart the computer, and then press **esc** while the “Press the ESC key for Startup Menu” message is displayed at the bottom of the screen.
2. Press **f10** to enter Computer Setup.
3. Use a pointing device or the arrow keys to select **System Configuration > Boot Options**, and then press **enter**.
4. In the **MultiBoot Express Popup Delay (Sec)** field, enter the length of time in seconds that you want the computer to display the startup location menu before it defaults to the current MultiBoot setting. (When 0 is selected, the Express Boot startup location menu is not displayed.)
5. To save your changes and exit Computer Setup, click the **Save** icon in the lower-left corner of the screen, and then follow the on-screen instructions.

– or –

Use the arrow keys to select **Main > Save Changes and Exit**, and then press **enter**.

Your changes go into effect when the computer restarts.

## Entering MultiBoot Express preferences

When the Express Boot menu is displayed during startup, you have the following choices:

- To specify a boot device from the Express Boot menu, select your preference within the allotted time, and then press **enter**.
- To prevent the computer from defaulting to the current MultiBoot setting, press any key before the allotted time expires. The computer will not start until you select a boot device and press **enter**.
- To allow the computer to start according to the current MultiBoot settings, wait for the allotted time to expire.

## Using HP Sure Start (select models only)

Select computer models are configured with HP Sure Start, a technology that continuously monitors the computer's BIOS for attacks or corruption. If the BIOS becomes corrupted or is attacked, HP Sure Start automatically restores the BIOS to its previously safe state, without user intervention.

HP Sure Start is configured and already enabled so that most users can use the HP Sure Start default configuration. The default configuration can be customized by advanced users.

To access the latest documentation on HP Sure Start, go to <http://www.hp.com/support>, and select your country. Select **Drivers & Downloads**, and then follow the on-screen instructions.

---

# 8 Computer Setup (BIOS) and MultiBoot in Windows 8.1

## Using Computer Setup

Computer Setup, or Basic Input/Output System (BIOS), controls communication between all the input and output devices on the system (such as disk drives, display, keyboard, mouse, and printer). Computer Setup includes settings for the types of devices installed, the startup sequence of the computer, and the amount of system and extended memory.

---

 **NOTE:** Use extreme care when making changes in Computer Setup. Errors can prevent the computer from operating properly.

---

## Starting Computer Setup

---

 **NOTE:** An external keyboard or mouse connected to a USB port can be used with Computer Setup only if USB legacy support is enabled.

---

To start Computer Setup, follow these steps:

1. Turn on or restart the computer, and then press **esc** while the “Press the ESC key for Startup Menu” message is displayed at the bottom of the screen.
2. Press **f10** to enter Computer Setup.

## Navigating and selecting in Computer Setup

To navigate and select in Computer Setup, follow these steps:

1. Turn on or restart the computer, and then press **esc** while the “Press the ESC key for Startup Menu” message is displayed at the bottom of the screen.

---

 **NOTE:** You can use either a pointing device (TouchPad, pointing stick, or USB mouse) or the keyboard to navigate and make selections in Computer Setup.

---

2. Press **f10** to enter Computer Setup.
  - To select a menu or a menu item, use the **tab** key and the keyboard arrow keys and then press **enter**, or use a pointing device to click the item.
  - To scroll up and down, click the up arrow or the down arrow in the upper-right corner of the screen, or use the up arrow key or the down arrow key on the keyboard.
  - To close open dialog boxes and return to the main Computer Setup screen, press **esc**, and then follow the on-screen instructions.

To exit Computer Setup menus, choose one of the following methods:

- To exit Computer Setup menus without saving your changes:  
Click the **Exit** icon in the lower-right corner of the screen, and then follow the on-screen instructions.  
– or –  
Use the arrow keys to select **Main > Ignore Changes and Exit**, and then press [enter](#).
- To save your changes and exit Computer Setup menus:  
Click the **Save** icon in the lower-right corner of the screen, and then follow the on-screen instructions.  
– or –  
Use the arrow keys to select **Main > Save Changes and Exit**, and then press [enter](#).

Your changes go into effect when the computer restarts.

## Restoring factory settings in Computer Setup

---

 **NOTE:** Restoring defaults will not change the hard drive mode.

---

To return all settings in Computer Setup to the values that were set at the factory, follow these steps:

1. Turn on or restart the computer, and then press [esc](#) while the “Press the ESC key for Startup Menu” message is displayed at the bottom of the screen.
2. Press [f10](#) to enter Computer Setup.
3. Use a pointing device or the arrow keys to select **Main > Restore Defaults**.
4. Follow the on-screen instructions.
5. To save your changes and exit, click the **Save** icon in the lower-right corner of the screen, and then follow the on-screen instructions.  
– or –  
Use the arrow keys to select **Main > Save Changes and Exit**, and then press [enter](#).

Your changes go into effect when the computer restarts.

---

 **NOTE:** Your password settings and security settings are not changed when you restore the factory settings.

---

## Updating the BIOS

Updated versions of the BIOS may be available on the HP website.

Most BIOS updates on the HP website are packaged in compressed files called *SoftPaqs*.

Some download packages contain a file named *Readme.txt*, which contains information regarding installing and troubleshooting the file.

## Determining the BIOS version

To decide whether you need to update Setup Utility (BIOS), first determine the BIOS version on your computer.

BIOS version information (also known as *ROM date* and *System BIOS*) can be accessed by pressing [fn+esc](#) (if you are already in Windows) or by using Computer Setup.

To use Setup Utility (BIOS):

1. Start Computer Setup.
2. Use a pointing device or the arrow keys to select **Main > System Information**.
3. To exit Computer Setup without saving your changes, click the **Exit** icon in the lower-right corner of the screen, and then follow the on-screen instructions.

– or –

Use the arrow keys to select **Main > Ignore Changes and Exit**, and then press [enter](#).

To check for later BIOS versions, see [Downloading a BIOS update on page 82](#).

## Downloading a BIOS update

 **CAUTION:** To reduce the risk of damage to the computer or an unsuccessful installation, download and install a BIOS update only when the computer is connected to reliable external power using the AC adapter. Do not download or install a BIOS update while the computer is running on battery power, docked in an optional docking device, or connected to an optional power source. During the download and installation, follow these instructions:

Do not disconnect power on the computer by unplugging the power cord from the AC outlet.

Do not shut down the computer or initiate Sleep.

Do not insert, remove, connect, or disconnect any device, cable, or cord.

1. From the Start screen, type `support`, and then select the HP Support Assistant app.
2. Click **Updates and tune-ups**, and then click **Check for HP updates now**.
3. Follow the on-screen instructions.
4. At the download area, follow these steps:
  - a. Identify the most recent BIOS update and compare it to the BIOS version currently installed on your computer. Make a note of the date, name, or other identifier. You may need this information to locate the update later, after it has been downloaded to your hard drive.
  - b. Follow the on-screen instructions to download your selection to the hard drive.

Make a note of the path to the location on your hard drive where the BIOS update is downloaded. You will need to access this path when you are ready to install the update.

 **NOTE:** If you connect your computer to a network, consult the network administrator before installing any software updates, especially system BIOS updates.

BIOS installation procedures vary. Follow any instructions that are revealed on the screen after the download is complete. If no instructions are revealed, follow these steps:

1. From the Start screen, type `file`, and then select **File Explorer**.
2. Click your hard drive designation. The hard drive designation is typically Local Disk (C:).
3. Using the hard drive path you recorded earlier, open the folder that contains the update.
4. Double-click the file that has an `.exe` extension (for example, `filename.exe`).

The BIOS installation begins.

5. Complete the installation by following the on-screen instructions.



**NOTE:** After a message on the screen reports a successful installation, you can delete the downloaded file from your hard drive.

## Using MultiBoot

### About the boot device order

As the computer starts, the system attempts to boot from enabled devices. The MultiBoot utility, which is enabled at the factory, controls the order in which the system selects a boot device. Boot devices can include optical drives, diskette drives, a network interface card (NIC), hard drives, and USB devices. Boot devices contain bootable media or files that the computer needs to start and operate properly.



**NOTE:** Some boot devices must be enabled in Computer Setup before they can be included in the boot order.

You can change the order in which the computer searches for a boot device by changing the boot order in Computer Setup. You can also press **esc** while the “Press the ESC key for Startup Menu” message is displayed at the bottom of the screen, and then press **f9**. Pressing **f9** displays a menu that shows the current boot devices and allows you to select a boot device. Or, you can use MultiBoot Express to set the computer to prompt you for a boot location each time the computer turns on or restarts.

### Choosing MultiBoot preferences

You can use MultiBoot in the following ways:

- To set a new boot order that the computer uses each time it is turned on, by changing the boot order in Computer Setup.
- To dynamically choose the boot device, by pressing **esc** while the “Press the ESC key for Startup Menu” message is displayed at the bottom of the screen, and then pressing **f9** to enter the Boot Device Options menu.
- To use MultiBoot Express to set variable boot orders. This feature prompts you for a boot device each time the computer is turned on or restarted.

### Setting a new boot order in Computer Setup

To start Computer Setup and set a boot device order that the computer uses each time it is turned on or restarted, follow these steps:

1. Turn on or restart the computer, and then press **esc** while the “Press the ESC key for Startup Menu” message is displayed at the bottom of the screen.
2. Press **f10** to enter Computer Setup.
3. Use a pointing device or the arrow keys to select one of the following options:
  - **Advanced > Boot Options > UEFI Boot Order > UEFI Hybrid**
  - **Advanced > Boot Options > UEFI Boot Order > UEFI Native Boot mode**
  - **Advanced > Boot Options > Legacy Boot Order > Legacy Boot Mode**Press **enter**.
4. To move the device up in the boot order, use a pointing device to click the up arrow, or press the **+** key.  
– or –

To move the device down in the boot order, use a pointing device to click the down arrow, or press the **-** key.

5. To save your changes and exit Computer Setup, click the **Save** icon in the lower-left corner of the screen, and then follow the on-screen instructions.

– or –

Use the arrow keys to select **Main > Save Changes and Exit**, and then press **enter**.

## Dynamically choosing a boot device using the f9 prompt

To dynamically choose a boot device for the current startup sequence, follow these steps:

1. Open the Select Boot Device menu by turning on or restarting the computer, and then pressing **esc** while the “Press the ESC key for Startup Menu” message is displayed at the bottom of the screen.
2. Press **f9**.
3. Use a pointing device or the arrow keys to select a boot device, then press **enter**.

## Setting a MultiBoot Express prompt

To start Computer Setup and set the computer to display the MultiBoot startup location menu each time the computer is started or restarted, follow these steps:

1. Turn on or restart the computer, and then press **esc** while the “Press the ESC key for Startup Menu” message is displayed at the bottom of the screen.
2. Press **f10** to enter Computer Setup.
3. Use a pointing device or the arrow keys to select **Advanced > Boot Options > MultiBoot Express Boot Popup Delay (Sec)**, and then press **enter**.
4. In the **MultiBoot Express Popup Delay (Sec)** field, enter the length of time in seconds that you want the computer to display the startup location menu before it defaults to the current MultiBoot setting. (When 0 is selected, the Express Boot startup location menu is not displayed.)
5. To save your changes and exit Computer Setup, click the **Save** icon in the lower-left corner of the screen, and then follow the on-screen instructions.

– or –

Use the arrow keys to select **Main > Save Changes and Exit**, and then press **enter**.

Your changes go into effect when the computer restarts.

## Entering MultiBoot Express preferences

When the Express Boot menu is displayed during startup, you have the following choices:

- To specify a boot device from the Express Boot menu, select your preference within the allotted time, and then press **enter**.
- To prevent the computer from defaulting to the current MultiBoot setting, press any key before the allotted time expires. The computer will not start until you select a boot device and press **enter**.
- To allow the computer to start according to the current MultiBoot settings, wait for the allotted time to expire.



## Using HP Sure Start (select models only)

Select computer models are configured with HP Sure Start, a technology that continuously monitors the computer's BIOS for attacks or corruption. If the BIOS becomes corrupted or is attacked, HP Sure Start automatically restores the BIOS to its previously safe state, without user intervention.

HP Sure Start is configured and already enabled so that most users can use the HP Sure Start default configuration. The default configuration can be customized by advanced users.

To access the latest documentation on HP Sure Start, go to <http://www.hp.com/support>, and select your country. Select **Drivers & Downloads**, and then follow the on-screen instructions.

---

# 9 Computer Setup (BIOS), TPM, and HP Sure Start in Windows 10

## Using Computer Setup

Computer Setup, or Basic Input/Output System (BIOS), controls communication between all the input and output devices on the system (such as disk drives, display, keyboard, mouse, and printer). Computer Setup includes settings for the types of devices installed, the startup sequence of the computer, and the amount of system and extended memory.

---

 **NOTE:** Use extreme care when making changes in Computer Setup. Errors can prevent the computer from operating properly.

---

## Starting Computer Setup

---

 **NOTE:** An external keyboard or mouse connected to a USB port can be used with Computer Setup only if USB legacy support is enabled.

---

To start Computer Setup, follow these steps:

- ▲ Start Computer Setup.
  - Computers or tablets with keyboards:
    - ▲ Turn on or restart the computer, and when the HP logo appears, press **F10** to enter Computer Setup.
  - Tablets without keyboards:
    - ▲ Turn off the tablet. Press the power button in combination with the volume down button until the Startup menu is displayed, and then tap **F10** to enter Computer Setup.

## Navigating and selecting in Computer Setup

- To select a menu or a menu item, use the **tab** key and the keyboard arrow keys and then press **enter**, or use a pointing device to select the item.

---

 **NOTE:** On tablets without keyboards, you can use your finger to make selections.

---

- To scroll up and down, select the up arrow or the down arrow in the upper-right corner of the screen, or use the up arrow key or the down arrow key on the keyboard.
- To close open dialog boxes and return to the main Computer Setup screen, press **esc**, and then follow the on-screen instructions.

To exit Computer Setup menus, choose one of the following methods:

- To exit Computer Setup menus without saving your changes:  
Select the **Exit** icon in the lower-right corner of the screen, and then follow the on-screen instructions.  
– or –  
Select **Main**, select **Ignore Changes and Exit**, and then press [enter](#).
- To save your changes and exit Computer Setup menus:  
Select the **Save** icon in the lower-right corner of the screen, and then follow the on-screen instructions.  
– or –  
Select **Main**, select **Save Changes and Exit**, and then press [enter](#).

Your changes go into effect when the computer restarts.

## Restoring factory settings in Computer Setup

---

 **NOTE:** Restoring defaults will not change the hard drive mode.

---

To return all settings in Computer Setup to the values that were set at the factory, follow these steps:

1. Start Computer Setup. See [Starting Computer Setup on page 86](#).
2. Select **Main**, and then select **Apply Factory Defaults and Exit**.

---

 **NOTE:** On select products, the selections may display **Restore Defaults** instead of **Apply Factory Defaults and Exit**.

---

3. Follow the on-screen instructions.
4. To save your changes and exit, select the **Save** icon in the lower-right corner of the screen, and then follow the on-screen instructions.  
– or –  
Select **Main**, select **Save Changes and Exit**, and then press [enter](#).

Your changes go into effect when the computer restarts.

---

 **NOTE:** Your password settings and security settings are not changed when you restore the factory settings.

---

## Updating the BIOS

Updated versions of the BIOS may be available on the HP website.

Most BIOS updates on the HP website are packaged in compressed files called *SoftPaqs*.

Some download packages contain a file named *Readme.txt*, which contains information regarding installing and troubleshooting the file.

### Determining the BIOS version

To decide whether you need to update Computer Setup (BIOS), first determine the BIOS version on your computer.

BIOS version information (also known as *ROM date* and *System BIOS*) can be accessed by pressing **fn+esc** (if you are already in Windows) or by using Computer Setup.

1. Start Computer Setup. See [Starting Computer Setup on page 86](#).
2. Select **Main**, and then select **System Information**.
3. To exit Computer Setup without saving your changes, select the **Exit** icon in the lower-right corner of the screen, and then follow the on-screen instructions.

– or –

Select **Main**, select **Ignore Changes and Exit**, and then press **enter**.

To check for later BIOS versions, see [Downloading a BIOS update on page 88](#).

### Downloading a BIOS update

 **CAUTION:** To reduce the risk of damage to the computer or an unsuccessful installation, download and install a BIOS update only when the computer is connected to reliable external power using the AC adapter. Do not download or install a BIOS update while the computer is running on battery power, docked in an optional docking device, or connected to an optional power source. During the download and installation, follow these instructions:

Do not disconnect power on the computer by unplugging the power cord from the AC outlet.

Do not shut down the computer or initiate Sleep.

Do not insert, remove, connect, or disconnect any device, cable, or cord.

1. Type `support` in the taskbar search box, and then select the HP Support Assistant app.  
– or –  
Select the question mark icon in the taskbar.
2. Select **Updates**, and then select **Check for updates and messages**.
3. Follow the on-screen instructions.
4. At the download area, follow these steps:
  - a. Identify the most recent BIOS update and compare it to the BIOS version currently installed on your computer. Make a note of the date, name, or other identifier. You may need this information to locate the update later, after it has been downloaded to your hard drive.
  - b. Follow the on-screen instructions to download your selection to the hard drive.  
Make a note of the path to the location on your hard drive where the BIOS update is downloaded. You will need to access this path when you are ready to install the update.

---

 **NOTE:** If you connect your computer to a network, consult the network administrator before installing any software updates, especially system BIOS updates.

---

BIOS installation procedures vary. Follow any instructions that are revealed on the screen after the download is complete. If no instructions are revealed, follow these steps:

1. Type `file` in the taskbar search box, and then select **File Explorer**.
2. Select your hard drive designation. The hard drive designation is typically Local Disk (C:).
3. Using the hard drive path you recorded earlier, open the folder that contains the update.
4. Double-click the file that has an .exe extension (for example, *filename.exe*).  
The BIOS installation begins.
5. Complete the installation by following the on-screen instructions.

---

 **NOTE:** After a message on the screen reports a successful installation, you can delete the downloaded file from your hard drive.

---

## Changing the boot order using the f9 prompt

To dynamically choose a boot device for the current startup sequence, follow these steps:

1. Access the Boot Device Options menu:
  - Computers or tablets with keyboards:
    - ▲ Turn on or restart the computer, and when the HP logo appears, press **f9** to enter the Boot Device Options menu.
  - Tablets without keyboards:
    - ▲ Turn off the tablet. Press the power button in combination with the volume down button until the Startup menu is displayed, and then tap **F9** to enter the Boot Device Options menu.
2. Select a boot device, then press `enter`.

## TPM BIOS settings (select products only)

---

 **IMPORTANT:** Before enabling Trusted Platform Module (TPM) functionality on this system, you must ensure that your intended use of TPM complies with relevant local laws, regulations and policies, and approvals or licenses must be obtained if applicable. For any compliance issues arising from your operation/usage of TPM which violates the above mentioned requirement, you shall bear all the liabilities wholly and solely. HP will not be responsible for any related liabilities.

---

TPM provides additional security for your computer. You can modify the TPM settings in Computer Setup (BIOS).

---

 **NOTE:** If you change the TPM setting to Hidden, TPM is not visible in the operating system.

---

To access TPM settings in Computer Setup:

1. Start Computer Setup. See [Starting Computer Setup on page 86](#).
2. Select **Security**, select **TPM Embedded Security**, and then follow the on-screen instructions.

## Using HP Sure Start (select products only)

Select computer models are configured with HP Sure Start, a technology that continuously monitors the computer's BIOS for attacks or corruption. If the BIOS becomes corrupted or is attacked, HP Sure Start automatically restores the BIOS to its previously safe state, without user intervention.

HP Sure Start is configured and already enabled so that most users can use the HP Sure Start default configuration. The default configuration can be customized by advanced users.

To access the latest documentation on HP Sure Start, go to <http://www.hp.com/support>, and select your country. Select **Drivers & Downloads**, and then follow the on-screen instructions.

---

# 10 Computer Setup (BIOS) in Ubuntu Linux

Computer Setup, or Basic Input/Output System (BIOS), controls communication between all the input and output devices on the system (such as disk drives, display, keyboard, mouse, and printer). Computer Setup includes settings for the types of peripherals installed, the startup sequence of the computer, and the amount of system and extended memory.

---

 **NOTE:** Use extreme care when making changes in Computer Setup. Errors can prevent the computer from operating properly.

---

## Starting Computer Setup

---

 **NOTE:** An external keyboard or mouse connected to a USB port can be used with Computer Setup only if USB legacy support is enabled.

---

To start Computer Setup, follow these steps:

1. Turn on or restart the computer, and then press **esc** while the “Press the ESC key for Startup Menu” message is displayed at the bottom of the screen.
2. Press **f10** to enter Computer Setup.

## Using Computer Setup

### Navigating and selecting in Computer Setup

To navigate and select in Computer Setup, follow these steps:

1. Turn on or restart the computer, and then press **esc** while the “Press the ESC key for Startup Menu” message is displayed at the bottom of the screen.
  - To select a menu or a menu item, use the **tab** key and the keyboard arrow keys and then press **enter**, or use a pointing device to click the item.
  - To scroll up and down, click the up arrow or the down arrow in the upper-right corner of the screen, or use the up arrow key or the down arrow key.
  - To close open dialog boxes and return to the main Computer Setup screen, press **esc**, and then follow the on-screen instructions.

---

 **NOTE:** You can use either a pointing device (TouchPad, pointing stick, or USB mouse) or the keyboard to navigate and make selections in Computer Setup.

---

2. Press **f10** to enter Computer Setup.

To exit Computer Setup menus, choose one of the following methods:

- To exit Computer Setup menus without saving your changes, click the **Exit** icon in the lower-left corner of the screen, and then follow the on-screen instructions.

– or –

Use the arrow keys to select **Main > Ignore Changes and Exit**, and then press **enter**.

– or –

- To save your changes and exit Computer Setup menus, click the **Save** icon in the lower-left corner of the screen, and then follow the on-screen instructions.

– or –

Use the arrow keys to select **Main > Save Changes and Exit**, and then press [enter](#).

Your changes go into effect when the computer restarts.

## Restoring factory settings in Computer Setup



**NOTE:** Restoring defaults will not change the hard drive mode.

To return all settings in Computer Setup to the values that were set at the factory, follow these steps:

1. Turn on or restart the computer, and then press [esc](#) while the “Press the ESC key for Startup Menu” message is displayed at the bottom of the screen.
2. Press [f10](#) to enter Computer Setup.
3. Use a pointing device or the arrow keys to select **Main > Restore Defaults**.
4. Follow the on-screen instructions.
5. To save your changes and exit, click the **Save** icon in the lower-left corner of the screen, and then follow the on-screen instructions.

– or –

Use the arrow keys to select **Main > Save Changes and Exit**, and then press [enter](#).

Your changes go into effect when the computer restarts.



**NOTE:** Your password settings and security settings are not changed when you restore the factory settings.

## Updating the BIOS

Updated versions of the BIOS may be available on the HP Web site.

Most BIOS updates on the HP Web site are packaged in compressed files called *SoftPaqs*.

Some download packages contain a file named `Readme.txt`, which contains information regarding installing and troubleshooting the file.

## Determining the BIOS version

To determine whether available BIOS updates contain later BIOS versions than those currently installed on the computer, you need to know the version of the system BIOS currently installed.

BIOS version information (also known as *ROM date* and *System BIOS*) can be revealed as follows:

1. Start Computer Setup.
2. Use a pointing device or the arrow keys to select **Main > System Information**.
3. To exit Computer Setup without saving your changes, click the **Exit** icon in the lower-left corner of the screen, and then follow the on-screen instructions.

– or –

Use the arrow keys to select **Main > Ignore Changes and Exit**, and then press [enter](#).



---

 **NOTE:** You can also determine the BIOS version by turning on or restarting the computer, pressing the **esc** key while the “Press the ESC key for Startup Menu” message is displayed at the bottom of the screen, and then pressing the **f1** key. Follow the on-screen instructions to exit this screen.

---

## Downloading a BIOS update

 **CAUTION:** To reduce the risk of damage to the computer or an unsuccessful installation, download and install a BIOS update only when the computer is connected to reliable external power using the AC adapter. Do not download or install a BIOS update while the computer is running on battery power, docked in an optional docking device, or connected to an optional power source. During the download and installation, follow these instructions:

Do not disconnect power from the computer by unplugging the power cord from the AC outlet.

Do not shut down the computer or initiate Suspend or Hibernation.

Do not insert, remove, connect, or disconnect any device, cable, or cord.

---

1. Open your web browser. For U.S. support, go to <http://www.hp.com/go/contactHP>. For worldwide support, go to [http://welcome.hp.com/country/us/en/wwcontact\\_us.html](http://welcome.hp.com/country/us/en/wwcontact_us.html).
2. Follow the on-screen instructions to identify your computer and access the BIOS update you want to download.
3. Click the option for software and driver downloads, type your computer model number in the product box, and then press **enter**. Follow the on-screen instructions to identify your computer and access the BIOS update you want to download.
4. Click your specific product from the models listed.
5. Click the appropriate operating system.
6. Go to the BIOS section and download the BIOS software package.
7. Follow the installation instructions as provided with the downloaded BIOS software package.

 **NOTE:** After a message on the screen reports a successful installation, you can delete the downloaded file from your hard drive.

---

---

# 11 HP PC Hardware Diagnostics (UEFI)

HP PC Hardware Diagnostics is a Unified Extensible Firmware Interface (UEFI) that allows you to run diagnostic tests to determine whether the computer hardware is functioning properly. The tool runs outside the operating system so that it can isolate hardware failures from issues that are caused by the operating system or other software components.

---

 **NOTE:** To start diagnostics on a convertible computer, your computer must be in notebook mode and you must use the keyboard attached to your tablet.

---

To start HP PC Hardware Diagnostics (UEFI), follow these steps:

1. Turn on or restart the computer, quickly press **esc**.
2. Press or tap **f2**.

The BIOS searches three places for the diagnostic tools, in the following order:

- a. Connected USB drive

---

 **NOTE:** To download the HP PC Hardware Diagnostics (UEFI) tool to a USB drive, see [Downloading HP PC Hardware Diagnostics \(UEFI\) to a USB device on page 94](#).

---

- b. Hard drive
- c. BIOS

3. When the diagnostic tool opens, select the type of diagnostic test you want to run, and then follow the on-screen instructions.

---

 **NOTE:** If you need to stop a diagnostic test, press **esc**.

---

## Downloading HP PC Hardware Diagnostics (UEFI) to a USB device

---

 **NOTE:** The HP PC Hardware Diagnostics (UEFI) download instructions are provided in English only, and you must use a Windows computer to download and create the HP UEFI support environment because only .exe files are offered.

---

There are two options to download HP PC Hardware Diagnostics to a USB device:

### Download the latest UEFI version

1. Go to <http://www.hp.com/go/techcenter/pcdiags>. The HP PC Diagnostics home page is displayed.
2. In the HP PC Hardware Diagnostics section, click the **Download** link, and then select **Run**.

### Download any version of UEFI for a specific product

1. Go to <http://www.hp.com/support>, and then select your country. The HP Support page is displayed.
2. Click **Drivers & Downloads**.
3. In the text box, enter the product name, and then click **Go**.

– or –

Click **Find Now** to let HP automatically detect your product.

4. Select your computer, and then select your operating system.
5. In the **Diagnostic** section, follow the on-screen instructions to select and download the UEFI version you want.

---

## 12 Backup and recovery in Windows 7

Your computer includes HP and Windows tools to help you safeguard your information and retrieve it if you ever need to. These tools will help you return your computer to a proper working state, all with simple steps. This section provides information about the following processes:

- Creating recovery media and backups
- Restoring and recovering your system

### Creating recovery media and backups

Recovery after a system failure is only as good as your most recent backup.

1. After you successfully set up the computer, create HP Recovery media. This step creates a Windows 7 operating system DVD and a *Driver Recovery* DVD. The Windows DVD can be used to reinstall the original operating system in cases where the hard drive is corrupted or has been replaced. The *Driver Recovery* DVD installs specific drivers and applications. See [Creating recovery media with HP Recovery Disc Creator on page 96](#).
2. Use Windows Backup and Recovery tools to perform the following:
  - Back up individual files and folders
  - Back up your entire hard drive (select models only)
  - Create system repair discs (select models only) with the installed optical drive (select models only) or an optional external optical drive
  - Create system restore points

---

 **NOTE:** This guide describes an overview of backing up, restoring, and recovering options. For more details about the tools provided, see Help and Support. To access Help and Support, select **Start > Help and Support**.

 **NOTE:** HP recommends that you print the recovery procedures and save them for later use, in case of system instability.

---

In case of system failure, you can use the backup files to restore the contents of your computer. See [Backing up your information on page 97](#).

### Guidelines

- When creating recovery media or backing up to discs, use any of the following types of discs (purchased separately): DVD+R, DVD+R DL, DVD-R, DVD-R DL, or DVD±RW. The discs you use will depend on the type of optical drive you are using.
- Be sure that the computer is connected to AC power before you start the recovery media creation process or the backup process.

### Creating recovery media with HP Recovery Disc Creator

HP Recovery Disc Creator is a software program that offers an alternative way to create recovery media. After you successfully set up the computer, you can create recovery media using HP Recovery Disc Creator. This recovery media allows you to reinstall your original operating system as well as select drivers and

applications if the hard drive becomes corrupted. HP Recovery Disc Creator can create two kinds of recovery DVDs:

- Windows 7 operating system DVD—Installs the operating system without additional drivers or applications.
- *Driver Recovery* DVD—Installs specific drivers and applications only, in the same way that the HP Software Setup utility installs drivers and applications.

## Creating recovery media

---

 **NOTE:** The Windows 7 operating system DVD can be created only once. Thereafter, the option to create that media will not be available after you create a Windows DVD.

---

To create the Windows DVD:

1. Select **Start > All Programs > Productivity and Tools > HP Recovery Disc Creator**.
2. Select **Windows disk**.
3. From the drop-down menu, select the drive for burning the recovery media.
4. Click the **Create** button to start the burning process.

After the Windows 7 operating system DVD has been created, create the *Driver Recovery* DVD:

1. Select **Start > All Programs > Productivity and Tools > HP Recovery Disc Creator**.
2. Select **Driver disk**.
3. From the drop-down menu, select the drive for burning the recovery media.
4. Click the **Create** button to start the burning process.

## Backing up your information

You should create system repair media and your initial backup immediately after initial system setup. As you add new software and data files, you should continue to back up your system on a regular basis to maintain a reasonably current backup. You should also create Windows system repair media (select models only) which can be used to start up (boot) the computer and repair the operating system in case of system instability or failure. Your initial and subsequent backups allow you to restore your data and settings if a failure occurs.

You can back up your information to an optional external hard drive, a network drive, or discs.

Note the following when backing up:

- Store personal files in the Documents library, and back it up regularly.
- Back up templates that are stored in their associated directories.
- Save customized settings that appear in a window, toolbar, or menu bar by taking a screen shot of your settings. The screen shot can be a time-saver if you have to reset your preferences.
- When backing up to discs, number each disc after removing it from the drive.

---

 **NOTE:** For detailed instructions on various backup and restore options, perform a search for these topics in Help and Support. To access Help and Support, select **Start > Help and Support**.

 **NOTE:** Windows includes the User Account Control feature to improve the security of your computer. You may be prompted for your permission or password for tasks such as installing software, running utilities, or changing Windows settings. Refer to Help and Support. To access Help and Support, select **Start > Help and Support**.

---

To create a backup using Windows Backup and Restore:

---

 **NOTE:** The backup process may take over an hour, depending on file size and the speed of the computer.

---

1. Select **Start > All Programs > Maintenance > Backup and Restore**.
2. Follow the on-screen instructions to set up your backup, create a system image (select models only), or create system repair media (select models only).

## Performing a system recovery

In case of system failure or instability, the computer provides the following tools to recover your files:

- Windows recovery tools: You can use Windows Backup and Restore to recover information you have previously backed up. You can also use Windows Startup Repair to fix problems that might prevent Windows from starting correctly.
- f11 recovery tools (select models only): You can use the f11 recovery tools to recover your original hard drive image. The image includes the Windows operating system and software programs installed at the factory.

---

 **NOTE:** If you are unable to boot (start up) your computer and you cannot use the system repair media you previously created (select models only), you must purchase Windows 7 operating system media to reboot the computer and repair the operating system. For additional information, see [Using Windows 7 operating system media on page 99](#).

---

## Using the Windows recovery tools

Using the Windows recovery tools, you can:

- Recover individual files
- Restore the computer to a previous system restore point
- Recover information using recovery tools

---

 **NOTE:** For detailed instructions on various recovery and restore options, perform a search for these topics in Help and Support. To access Help and Support, select **Start > Help and Support**.

 **NOTE:** Windows includes the User Account Control feature to improve the security of your computer. You may be prompted for your permission or password for tasks such as installing software, running utilities, or changing Windows settings. Refer to Help and Support. To access Help and Support, select **Start > Help and Support**.

---

To recover information you previously backed up:

1. Select **Start > All Programs > Maintenance > Backup and Restore**.
2. Follow the on-screen instructions to recover your system settings, your computer (select models only), or your files.

To recover your information using Startup Repair, follow these steps:

---

 **CAUTION:** Some Startup Repair options will completely erase and reformat the hard drive. All files you have created and any software installed on the computer are permanently removed. When reformatting is complete, the recovery process restores the operating system, as well as the drivers, software, and utilities from the backup used for recovery.

---

1. If possible, back up all personal files.
2. If possible, check for the presence of the Windows partition.

To check for the Windows partition, select **Start > Computer**.



**NOTE:** If the Windows partition is not listed, you must recover your operating system and programs using the Windows 7 operating system DVD and the *Driver Recovery* media. For additional information, see [Using Windows 7 operating system media on page 99](#).

3. If the Windows partition is listed, restart the computer, and then press **f8** before the Windows operating system loads.
4. Select **Startup Repair**.
5. Follow the on-screen instructions.



**NOTE:** For additional information on recovering information using the Windows tools, select **Start > Help and Support**.

## Using f11 recovery tools (select models only)

**CAUTION:** Using **f11** completely erases hard drive contents and reformats the hard drive. All files that you have created and any software that you have installed on the computer are permanently removed. The **f11** recovery tool reinstalls the operating system and HP programs and drivers that were installed at the factory. Software not installed at the factory must be reinstalled.

To recover the original hard drive image using **f11**:

1. If possible, back up all personal files.
2. If possible, check for the presence of the HP Recovery partition: click **Start**, right-click **Computer**, click **Manage**, and then click **Disk Management**.



**NOTE:** If the HP Recovery partition is not listed, you must recover your operating system and programs using the Windows 7 operating system media and the *Driver Recovery* media. For additional information, see [Using Windows 7 operating system media on page 99](#).

3. If the HP Recovery partition is listed, restart the computer, and then press **esc** while the “Press the ESC key for Startup Menu” message is displayed at the bottom of the screen.
4. Press **f11** while the “Press <F11> for recovery” message is displayed on the screen.
5. Follow the on-screen instructions.

## Using Windows 7 operating system media

If you cannot use the recovery media you previously created using the HP Recovery Disc Creator (select models only), you must purchase a Windows 7 operating system DVD to reboot the computer and repair the operating system.

To order a Windows 7 operating system DVD, go to the HP website. For U.S. support, go to <http://www.hp.com/support>. For worldwide support, go to [http://welcome.hp.com/country/us/en/wwcontact\\_us.html](http://welcome.hp.com/country/us/en/wwcontact_us.html). You can also order the DVD by calling support. For contact information, see the *Worldwide Telephone Numbers* booklet included with the computer.

**CAUTION:** Using a Windows 7 operating system DVD completely erases hard drive contents and reformats the hard drive. All files that you have created and any software that you have installed on the computer are permanently removed. When reformatting is complete, the recovery process helps you restore the operating system, as well as drivers, software, and utilities.

To initiate recovery using a Windows 7 operating system DVD:



---

**NOTE:** This process takes several minutes.

---

1. If possible, back up all personal files.
2. Restart the computer, and then insert the Windows 7 operating system DVD into the optical drive before the Windows operating system loads.
3. When prompted, press any keyboard key.
4. Follow the on-screen instructions.
5. Click **Next**.
6. Select **Repair your computer**.
7. Follow the on-screen instructions.

After the repair is completed:

1. Eject the Windows 7 operating system DVD and then insert the *Driver Recovery* DVD.
2. Install the Hardware Enabling Drivers first, and then install Recommended Applications.



---

# 13 Backup and recovery in Windows 8.1

To protect your information, use Windows backup and restore utilities to back up individual files and folders, back up your entire hard drive, create system repair media (select models only) by using the installed optical drive (select models only) or an optional external optical drive, or create system restore points. In case of system failure, you can use the backup files to restore the contents of your computer.

From the Start screen, type `restore`, and then select from the list of displayed options.

---

 **NOTE:** For detailed instructions on various backup and restore options, perform a search for these topics in Windows Help and Support.

In case of system instability, HP recommends that you print the recovery procedures and save them for later use.

 **NOTE:** Windows includes the User Account Control feature to improve the security of your computer. You may be prompted for your permission or password for tasks such as installing software, running utilities, or changing Windows settings. For more information, see Windows Help and Support.

---

## Backing up your information

Recovery after a system failure is as good as your most recent backup. You should create system repair media and your initial backup immediately after initial system setup. As you add new software and data files, you should continue to back up your system on a regular basis to maintain a reasonably current backup.

For more information on the Windows backup features, see Windows Help and Support.

## Performing a system recovery

In case of system failure or instability, the computer provides the following tools to recover your files:

- **Windows recovery tools:** You can use Windows Backup and Restore to recover information you have previously backed up. You can also use Windows Automatic Repair to fix problems that might prevent Windows from starting correctly.
- **f11 recovery tools:** You can use the [f11](#) recovery tools to recover your original hard drive image. The image includes the Windows operating system and software programs installed at the factory.

---

 **NOTE:** If you are unable to boot (start up) your computer and you cannot use the system repair media you previously created (select models only), you must purchase Windows operating system media to reboot the computer and repair the operating system. For additional information, see [Using Windows operating system media \(purchased separately\) on page 103](#).

---

## Using the Windows recovery tools

To recover information you previously backed up, see Windows Help and Support for steps on restoring files and folders.

To recover your information using Automatic Repair, follow these steps:

---

 **CAUTION:** Some Startup Repair options will completely erase and reformat the hard drive. All files you have created and any software installed on the computer are permanently removed. When reformatting is complete, the recovery process restores the operating system, as well as the drivers, software, and utilities from the backup used for recovery.

---

1. If possible, back up all personal files.
2. If possible, check for the presence of the Recovery Image partition and the Windows partition.

From the Start screen, type `file`, and then click **File Explorer**.

– or –

From the Start screen, type `pc`, and then select **This PC**.

---

 **NOTE:** If the Windows partition and the Recovery Image partition are not listed, you must recover your operating system and programs using the Windows operating system DVD and the *Driver Recovery* media (both purchased separately). For additional information, see [Using Windows operating system media \(purchased separately\) on page 103](#).

---

3. If the Windows partition and the Recovery Image partition are listed, restart the computer by pressing and holding the `shift` key while clicking **Restart**.
4. Select **Troubleshoot**, then select **Advanced Options**, and then select **Startup Repair**.
5. Follow the on-screen instructions.

---

 **NOTE:** For additional information on recovering information using the Windows tools, perform a search for these topics in Windows Help and Support.

---

## Using f11 recovery tools

---

 **CAUTION:** Using `f11` completely erases hard drive contents and reformats the hard drive. All files that you have created and any software that you have installed on the computer are permanently removed. The `f11` recovery tool reinstalls the operating system and HP programs and drivers that were installed at the factory. Software not installed at the factory must be reinstalled.

---

To recover the original hard drive image using `f11`:

1. If possible, back up all personal files.
2. If possible, check for the presence of the Recovery Image partition: From the Start screen, type `pc`, and then select **This PC**.

---

 **NOTE:** If the Recovery Image partition is not listed, you must recover your operating system and programs using the Windows operating system media and the *Driver Recovery* media (both purchased separately). For additional information, see [Using Windows operating system media \(purchased separately\) on page 103](#).

---

3. If the Recovery Image partition is listed, restart the computer, and then press `esc` while the “Press the ESC key for Startup Menu” message is displayed at the bottom of the screen.
4. Press `f11` while the “Press <F11> for recovery” message is displayed on the screen.
5. Follow the on-screen instructions.

## Using Windows operating system media (purchased separately)

To order a Windows operating system DVD, contact support. See the *Worldwide Telephone Numbers* booklet included with the computer. You can also find contact information from the HP website. Go to <http://www.hp.com/support>, select your country or region, and follow the on-screen instructions.

 **CAUTION:** Using a Windows operating system media completely erases hard drive contents and reformats the hard drive. All files that you have created and any software that you have installed on the computer are permanently removed. When reformatting is complete, the recovery process helps you restore the operating system, as well as drivers, software, and utilities.

To initiate a full install of the operating system using a Windows operating system DVD:

 **NOTE:** This process takes several minutes.

1. If possible, back up all personal files.
2. Insert the Windows operating system DVD into the optical drive, and then restart the computer.
3. When prompted, press any keyboard key.
4. Follow the on-screen instructions.

After the installation is completed:

1. Eject the Windows operating system media and then insert the *Driver Recovery* media.
2. Install the Hardware Enabling Drivers first, and then install Recommended Applications.

## Using Windows Refresh or Windows Reset

When your computer is not working properly and you need to regain system stability, the Windows Refresh option allows you to start fresh and keep what is important to you.

The Windows Reset option allows you to perform detailed reformatting of your computer, or remove personal information before you give away or recycle your computer. For more information on these features, see Windows Help and Support.

## Using HP Software Setup

HP Software Setup can be used to reinstall drivers or select software that has been corrupted or deleted from the system.

1. From the Start screen, type `HP Software Setup`.
2. Open HP Software Setup.
3. Follow the on-screen directions to reinstall drivers or select software.

---

# 14 Backup and recovery in Windows 10

This chapter provides information about the following processes. The information in the chapter is standard procedure for most products.

- Creating recovery media and backups
- Restoring and recovering your system

For additional information, refer to the HP support assistant app.

▲ Type `support` in the taskbar search box, and then select the **HP Support Assistant** app.

– or –

Click the question mark icon in the taskbar.

---

 **IMPORTANT:** If you will be performing recovery procedures on a tablet, the tablet battery must be at least 70% charged before you start the recovery process.

**IMPORTANT:** For a tablet with a detachable keyboard, connect the keyboard to the keyboard dock before beginning any recovery process.

---

## Creating recovery media and backups

The following methods of creating recovery media and backups are available on select products only. Choose the available method according to your computer model.

- Use HP Recovery Manager to create HP Recovery media after you successfully set up the computer. This step creates a backup of the HP Recovery partition on the computer. The backup can be used to reinstall the original operating system in cases where the hard drive is corrupted or has been replaced. For information on creating recovery media, see [Creating HP Recovery media \(select products only\) on page 104](#). For information on the recovery options that are available using the recovery media, see [Using Windows tools on page 105](#).
- Use Windows tools to create system restore points and create backups of personal information.

For more information, see [Recovering using HP Recovery Manager on page 106](#).

---

 **NOTE:** If storage is 32 GB or less, Microsoft System Restore is disabled by default.

---

## Creating HP Recovery media (select products only)

If possible, check for the presence of the Recovery partition and the Windows partition. From the **Start** menu, select **File Explorer**, and then select **This PC**.

- If your computer does not list the Windows partition and the Recovery partition, you can obtain recovery media for your system from support. See the *Worldwide Telephone Numbers* booklet included with the computer. You can also find contact information on the HP website. Go to <http://www.hp.com/support>, select your country or region, and follow the on-screen instructions.

You can use Windows tools to create system restore points and create backups of personal information, see [Using Windows tools on page 105](#).

- If your computer does list the Recovery partition and the Windows partition, you can use HP Recovery Manager to create recovery media after you successfully set up the computer. HP Recovery media can be used to perform system recovery if the hard drive becomes corrupted. System recovery reinstalls the original operating system and software programs that were installed at the factory and then configures the settings for the programs. HP Recovery media can also be used to customize the system or restore the factory image if you replace the hard drive.
  - Only one set of recovery media can be created. Handle these recovery tools carefully, and keep them in a safe place.
  - HP Recovery Manager examines the computer and determines the required storage capacity for the media that will be required.
  - To create recovery discs, your computer must have an optical drive with DVD writer capability, and you must use only high-quality blank DVD-R, DVD+R, DVD-R DL, or DVD+R DL discs. Do not use rewritable discs such as CD±RW, DVD±RW, double-layer DVD±RW, or BD-RE (rewritable Blu-ray) discs; they are not compatible with HP Recovery Manager software. Or, instead, you can use a high-quality blank USB flash drive.
  - If your computer does not include an integrated optical drive with DVD writer capability, but you would like to create DVD recovery media, you can use an external optical drive (purchased separately) to create recovery discs. If you use an external optical drive, it must be connected directly to a USB port on the computer; the drive cannot be connected to a USB port on an external device, such as a USB hub. If you cannot create DVD media yourself, you can obtain recovery discs for your computer from HP. See the *Worldwide Telephone Numbers* booklet included with the computer. You can also find contact information on the HP website. Go to <http://www.hp.com/support>, select your country or region, and follow the on-screen instructions.
  - Be sure that the computer is connected to AC power before you begin creating the recovery media.
  - The creation process can take an hour or more. Do not interrupt the creation process.
  - If necessary, you can exit the program before you have finished creating all of the recovery DVDs. HP Recovery Manager will finish burning the current DVD. The next time you start HP Recovery Manager, you will be prompted to continue.

To create HP Recovery media:

---

 **IMPORTANT:** For a tablet with a detachable keyboard, connect the keyboard to the keyboard dock before beginning these steps.

---

1. Type `recovery` in the taskbar search box, and then select **HP Recovery Manager**.
2. Select **Create recovery media**, and then follow the on-screen instructions.

If you ever need to recover the system, see [Recovering using HP Recovery Manager on page 106](#).

## Using Windows tools

You can create recovery media, system restore points, and backups of personal information using Windows tools.

---

 **NOTE:** If storage is 32 GB or less, Microsoft System Restore is disabled by default.

---

For more information and steps, see the Get started app.

- ▲ Select the **Start** button, and then select the **Get started** app.

## Restore and recovery

There are several options for recovering your system. Choose the method that best matches your situation and level of expertise:

---

 **IMPORTANT:** Not all methods are available on all products.

---

- Windows offers several options for restoring from backup, refreshing the computer, and resetting the computer to its original state. For more information see the Get started app.
  - ▲ Select the **Start** button, and then select the **Get started** app.
- If you need to correct a problem with a preinstalled application or driver, use the Reinstall drivers and/or applications option (select products only) of HP Recovery Manager to reinstall the individual application or driver.
  - ▲ Type `recovery` in the taskbar search box, select **HP Recovery Manager**, select **Reinstall drivers and/or applications**, and then follow the on-screen instructions.
- If you want to recover the Windows partition to original factory content, you can choose the System Recovery option from the HP Recovery partition (select products only) or use the HP Recovery media. For more information, see [Recovering using HP Recovery Manager on page 106](#). If you have not already created recovery media, see [Creating HP Recovery media \(select products only\) on page 104](#).
- On select products, if you want to recover the computer's original factory partition and content, or if you have replaced the hard drive, you can use the Factory Reset option of HP Recovery media. For more information, see [Recovering using HP Recovery Manager on page 106](#).
- On select products, if you want to remove the recovery partition to reclaim hard drive space, HP Recovery Manager offers the Remove Recovery Partition option.

For more information, see [Removing the HP Recovery partition \(select products only\) on page 109](#).

## Recovering using HP Recovery Manager

HP Recovery Manager software allows you to recover the computer to its original factory state by using the HP Recovery media that you either created or that you obtained from HP, or by using the HP Recovery partition (select products only). If you have not already created recovery media, see [Creating HP Recovery media \(select products only\) on page 104](#).

## What you need to know before you get started

- HP Recovery Manager recovers only software that was installed at the factory. For software not provided with this computer, you must either download the software from the manufacturer's website or reinstall the software from the media provided by the manufacturer.

---

 **IMPORTANT:** Recovery through HP Recovery Manager should be used as a final attempt to correct computer issues.

---

- HP Recovery media must be used if the computer hard drive fails. If you have not already created recovery media, see [Creating HP Recovery media \(select products only\) on page 104](#).
- To use the Factory Reset option (select products only), you must use HP Recovery media. If you have not already created recovery media, see [Creating HP Recovery media \(select products only\) on page 104](#).
- If your computer does not allow the creation of HP Recovery media or if the HP Recovery media does not work, you can obtain recovery media for your system from support. See the *Worldwide Telephone Numbers* booklet included with the computer. You can also find contact information from the HP

website. Go to <http://www.hp.com/support>, select your country or region, and follow the on-screen instructions.

---

 **IMPORTANT:** HP Recovery Manager does not automatically provide backups of your personal data. Before beginning recovery, back up any personal data you want to retain.

---

Using HP Recovery media, you can choose from one of the following recovery options:

---

 **NOTE:** Only the options available for your computer display when you start the recovery process.

---

- System Recovery—Reinstalls the original operating system, and then configures the settings for the programs that were installed at the factory.
- Factory Reset—Restores the computer to its original factory state by deleting all information from the hard drive and re-creating the partitions. Then it reinstalls the operating system and the software that was installed at the factory.

The HP Recovery partition (select products only) allows System Recovery only.

## Using the HP Recovery partition (select products only)

The HP Recovery partition allows you to perform a system recovery without the need for recovery discs or a recovery USB flash drive. This type of recovery can be used only if the hard drive is still working.

To start HP Recovery Manager from the HP Recovery partition:

---

 **IMPORTANT:** For a tablet with a detachable keyboard, connect the keyboard to the keyboard dock before beginning these steps (select products only).

---

1. Type `recovery` in the taskbar search box, select **Recovery Manager**, and then select **HP Recovery Environment**.

- or -

For computers or tablets with keyboards attached, press **f11** while the computer boots, or press and hold **f11** as you press the power button.

For tablets without keyboards:

Turn on or restart the tablet, and then quickly hold down the volume down button; then select **f11**.

- or -

Turn on or restart the tablet, and then quickly hold down the Windows button; then select **f11**.

2. Select **Troubleshoot** from the boot options menu.
3. Select **Recovery Manager**, and then follow the on-screen instructions.

## Using HP Recovery media to recover

You can use HP Recovery media to recover the original system. This method can be used if your system does not have an HP Recovery partition or if the hard drive is not working properly.

1. If possible, back up all personal files.
2. Insert the HP Recovery media, and then restart the computer.

---

 **NOTE:** If the computer does not automatically restart in HP Recovery Manager, change the computer boot order. See [Changing the computer boot order on page 108](#).

---

3. Follow the on-screen instructions.

## Changing the computer boot order

If your computer does not restart in HP Recovery Manager, you can change the computer boot order, which is the order of devices listed in BIOS where the computer looks for startup information. You can change the selection to an optical drive or a USB flash drive.

To change the boot order:



---

**IMPORTANT:** For a tablet with a detachable keyboard, connect the keyboard to the keyboard dock before beginning these steps.

---

1. Insert the HP Recovery media.
2. Access BIOS:

For computers or tablets with keyboards attached:

- ▲ Turn on or restart the computer or tablet, quickly press **esc**, and then press **f9** for boot options.

For tablets without keyboards:

- ▲ Turn on or restart the tablet, and then quickly hold down the volume down button; then select **f9**.

- or -

Turn on or restart the tablet, and then quickly hold down the Windows button; then select **f9**.

3. Select the optical drive or USB flash drive from which you want to boot.
4. Follow the on-screen instructions.



## Removing the HP Recovery partition (select products only)

HP Recovery Manager software allows you to remove the HP Recovery partition to free up hard drive space.

---

 **IMPORTANT:** After you remove the HP Recovery partition, you will not be able to perform System Recovery or create HP recovery media from the HP Recovery partition. So before you remove the Recovery partition, create HP Recovery media; see [Creating HP Recovery media \(select products only\) on page 104](#).

---

 **NOTE:** The Remove Recovery Partition option is only available on products that support this function.

---

Follow these steps to remove the HP Recovery partition:

1. Type `recovery` in the taskbar search box, and then select **HP Recovery Manager**.
2. Select **Remove Recovery Partition**, and then follow the on-screen instructions.

---

# 15 Backup and Recovery in Ubuntu Linux

Recovery after a system failure is as good as your most recent backup. As you add new software and data files, you should continue to back up your system on a regular basis to maintain a reasonably current backup.

Your computer includes tools provided by HP to help you safeguard your information and retrieve it if ever needed.

## Creating backups

1. Create restore media immediately after you set up the computer. For more information, see [Performing a system recovery on page 111](#).
2. As you add files, routinely create a backup of your system and personal information.

## Backing up your information

You should back up your computer files on a regular schedule to maintain a current backup. You can manually back up your information to an optional external drive, a network drive, or discs. Back up your system at the following times:

- At regularly scheduled times
- Before the computer is repaired or restored
- Before you add or modify hardware or software

To back up your home directory files using **Backup Manager Settings**:

1. Select **Computer > More Applications > Tools > Backup Manager Settings**, and click **Backup my home directory**.
2. Click **Storage Destination Location**, and then select a location to back up your information.
3. Click **Schedule**, and then select a time schedule to perform backups at a regularly scheduled time.

To immediately back up your information, click the **Backup Now** check box.



**NOTE:** Before you back up your information, be sure you have designated a location to save the backup files.

4. Click **Save and Backup** to start the backup and to save the backup settings.

To restore backup files:

1. Select **Computer > More Applications > Tools > Backup Manager Restore**.
2. Click **Backup Source**, and then select the location of the backup files.
3. Click **Restore Destination**, and then select the destination to restore the files.
4. To restore all files from the selected location, click **Restore all files**. To restore select files only, click **Restore selected files**, click **Select Files** and then select the files to be restored.
5. Under **Restore Point**, click the time and date of the backup.

---

 **NOTE:** If multiple backups have been performed, click **Use the latest version** to restore the latest version.

---

6. Click **Restore** to start restoring the files, or click **Cancel** to cancel the operation.

## Performing a system recovery

Recovery allows you to repair or restore the computer to its original factory state. You can create an HP Factory Image, using an installed or an external DVD±RW optical drive.

 **NOTE:** Your computer may not come equipped with an internal optical drive. In order to create the HP Factory Image, you may need to plug in an external optical drive.

 **CAUTION:** Using Recovery completely erases hard drive contents and reformats the hard drive. All files you have created and any software installed on the computer are permanently removed. The recovery tool reinstalls the original operating system and HP programs and drivers that were installed at the factory. Software, drivers, and updates not installed by HP must be manually reinstalled. Personal files must be restored from a backup.

To restore the computer using the HP Factory Image, you must first create the recovery ISO file and then burn it to an optical disc.

 **NOTE:** HP recommends that you create the HP Factory Image in the event of a system failure.

---

1. Select **Computer > More Applications**.
2. In the left pane, click **Tools**, and then click **Create HP Factory Image** in the right pane.
3. Enter the root password when prompted.
4. Right-click on the HP\_Recovery.iso file and select **Open with Brasero**.
5. Insert a blank DVD disc and select **Burn**. This creates the HP Factory Image Restore DVD.

To restore the computer from the recovery disc, follow these steps:

1. If possible, back up all personal files.
2. Insert the HP Factory Image Restore DVD into the optical drive and restart the computer.
3. As the computer is restarting, press **f9** to open the Computer Setup boot option menu.
4. Select **Optical Disk Drive** from the Boot Options menu and press **enter**.
5. Press **enter** to select **Restore System from Media**.
6. At both of the System Recovery prompts, select **Yes**.

## USB Recovery option (select models only)

The USB Recovery Disk On Key (flash drive) option allows you to create a backup image of the Ubuntu operating system installed on select HP Business Notebooks. This Disk On Key may be used to restore the system to the original factory state when the F11 recovery option is not available. This process should be done on first obtaining the computer.

 **CAUTION:** The USB recovery option does not preserve data present on the computer's hard drive or on the Disk On Key used for the recovery process. Back up any data on the Disk on Key or the notebook that will be recovered before starting.

 **NOTE:** HP recommends that you create the USB Recovery Disk in the event of a system failure. The Disk On Key used for this process should be 4 GB or larger.

---

#### Creating a USB Recovery Disk On Key

1. Connect the USB Disk On Key to a USB port on the computer.
2. Select **Computer > More applications > Tools > Create Recovery USB**.
3. Enter the root password when prompted.
4. Select **USB Disk On Key** from the list.
5. Click **OK**.
6. A question dialog will remind you that the data on the USB key will be destroyed. To continue, click **OK**. Otherwise, click **Cancel** and back up the contents of the Disk On Key on another computer.
7. The backup process will display a status dialog box while the backup is in progress.

 **NOTE:** A file browser window with the Disk On Key Contents displayed will pop up when the key is mounted. You may close the file browser window if desired. Once the USB Recovery Key has been created, the status dialog will close. The USB Recovery Key is ready for use.

---

#### Recovering from a USB Recovery Disk On Key

 **CAUTION:** Before starting the Recovery process, make sure any data on the system to be recovered has been backed up. The recovery process destroys all data on the system to be recovered.

---

1. Turn off the computer.
2. Connect the USB Disk On Key to a USB port on the computer.
3. Turn on the computer while holding down the **f9** key.
4. Once the system has booted, the **Boot Options** menu should appear.
5. Using the arrow keys, select **USB Disk On Key** and press **enter**.

 **NOTE:** The description may vary from one USB key to another. Any entry other than Optical Disk Drive, Notebook Hard Drive or Notebook Ethernet should be the USB Recovery Disk On Key.

---

6. Once the USB Recovery Disk On Key has been selected, press **enter**. The USB Recovery Disk On Key will boot.
7. Once the USB Recovery Disk On Key has booted, a dialog box will prompt, “Do you want to start the System-Restore?” If data on the computer has not been backed up, use the **tab** key and select **No**. The system will reboot. Back up the system data and repeat the previous steps. If no data should be saved from the computer, use the **tab** key to select **Yes**. Press **enter** to begin the recovery process.
8. After the files are copied to the system, follow the on-screen instructions.

## Remove everything and reinstall Ubuntu

Sometimes you want to perform detailed reformatting of your computer, or you want to remove personal information before you give away or recycle your computer. The process described in this section provides a speedy, simple way to return the computer to its original state. This option removes all personal data, applications, and settings from your computer, and reinstalls the Linux operating system.

 **IMPORTANT:** This option does not provide backups of your information. Before using this option, back up any personal information you wish to retain.

---

You can initiate this option by using the **f11** key.

To use the **f11** key:

Press **f11** while the computer boots.

– or –

Press and hold **f11** as you press the power button.

The following options are available:

- **Cancel/Reboot**—Reboots the system. No recovery or restore activity is performed.
- **Recover/Repair System**—This option repairs a system that is not working properly and preserves user data.
- **Restore Factory System**—This option restores the system back to the original factory state. User data is not preserved.

Select an option and follow the on-screen instructions.

# 16 Specifications

## Computer specifications

	Metric	U.S.
<b>Dimensions</b>		
Length		
Non-touch	244.0 cm	9.61 in
Touch	244.2 mm	9.61 in
Width		
	339.2 mm	13.35 in
Height (front to rear)		
Non-touch	19.9 to 20.9 mm	0.78 to 0.83 in
Touch	21.5 to 22.5 mm	0.85 to 0.89 in
<b>Weight</b>		
Non-touch screen (equipped with 1 DIMM, M.2 SSD, WLAN module, webcam, 4 cell battery)	1.68 kg	3.69 lbs
Non-touch screen (equipped with 1 DIMM, hard drive, WLAN module, webcam, 4 cell battery)	1.76 kg	3.88 lbs
Touch screen (equipped with 1 DIMM, M.2 SSD, WLAN module, webcam, 4 cell battery)	2.21 kg	4.87 lbs
Touch screen (equipped with 1 DIMM, hard drive, WLAN module, webcam, 4 cell battery)	2.31 kg	5.09 lbs
Non-touch screen (equipped with 1 DIMM, M.2 SSD, WLAN module, webcam, 6 cell battery)	1.80 kg	3.96 lbs
Non-touch screen (equipped with 1 DIMM, hard drive, WLAN module, webcam, 6 cell battery)	1.88 kg	4.13 lbs
Touch screen (equipped with 1 DIMM, M.2 SSD, WLAN module, webcam, 6 cell battery)	2.33 kg	5.12 lbs
Touch screen (equipped with 1 DIMM, hard drive, WLAN module, webcam, 6 cell battery)	2.43 kg	5.34 lbs
<b>Input power</b>		
Operating voltage	19.0 V dc @ 4.74 A – 90 W or 18.5 V dc @ 3.5 A - 65 W	
Operating current	4.74 A or 3.5 A	
<b>Temperature</b>		
Operating (not writing to optical disc)	0°C to 35°C	32°F to 95°F
Operating (writing to optical disc)	5°C to 35°C	41°F to 95°F
Nonoperating	-20°C to 60°C	-4°F to 140°F
<b>Relative humidity</b>		

	<b>Metric</b>	<b>U.S.</b>
Operating	10% to 90%	
Nonoperating	5% to 95%	
<b>Maximum altitude</b> (unpressurized)		
Operating (14.7 to 10.1 psia)	-15 m to 3,048 m	50 ft to 10,000 ft
Nonoperating (14.7 to 4.4 psia)	-15 m to 12,192 m	-50 ft to 40,000 ft
<b>Shock</b>		
Operating	125 g, 2 ms, half-sine	
Nonoperating	200 g, 2 ms, half-sine	
<b>Random vibration</b>		
Operating	0.75 g zero-to-peak, 10 Hz to 500 Hz, 0.25 oct/min sweep rate	
Nonoperating	1.50 g zero-to-peak, 10 Hz to 500 Hz, 0.5 oct/min sweep rate	
<b>NOTE:</b> Applicable product safety standards specify thermal limits for plastic surfaces. The computer operates well within this range of temperatures.		

## 35.6-cm (14.0-in) display specifications

	<b>Metric</b>	<b>U.S.</b>
Active diagonal size	35.6-cm	14.0-in
Resolution	HD: 1366x768 FHD: 1600x900	
Surface treatment	Anti-glare	
Panel Width	HD: 3.6 mm FHD: 3.0 mm	
Brightness	HD: 220 nits (typical) FHD: 220 nits (typical)	
Viewing angle	SVA	
Backlight	WLED	
Viewing angle	45/45/15/35	
Frequency	60 Hz	
Display colors	262K	
Response time	2ms /6 ms(Typ)(Tr/Td)	

## Hard drive specifications

	1-TB*	750-GB*	500-GB*	500-GB* hybrid
<b>Dimensions</b>				
Height	9.5 mm	9.5 mm	9.5 mm or 7.0 mm	7.0 mm
Width	70 mm	70 mm	70 mm	70 mm
Weight	115 g	102 g	101 g or 95 g	95 g
<b>Interface type</b>	SATA	SATA	SATA	SATA
<b>Transfer rate</b>	100 MB/sec	100 MB/sec	100 MB/sec	100 MB/sec
<b>Security</b>	ATA security	ATA security	ATA security	ATA security
<b>Seek times</b> (typical read, including setting)				
Single track	1.4 ms	1.1 ms	3 ms	2 ms
Average	10 ms	12 ms	13 ms	12 ms
Maximum	12 ms	21 ms	24 ms	22 ms
<b>Logical blocks</b>	1,938,921,461	1,465,149,168	1,048,576,000	976,773,168
<b>Disc rotational speed</b>	5400 rpm	7200 or 5400 rpm	7200 rpm or 5400 rpm	5400 rpm
<b>Operating temperature</b>				
*1 GB = 1 billion bytes when referring to hard drive storage capacity. Actual accessible capacity is less. Actual drive specifications may differ slightly.				
<b>NOTE:</b> Certain restrictions and exclusions apply. Contact technical support for details.				



## Solid-state drive specifications

	128-GB*	256-GB*
<b>Height</b>	1.35 mm	1.35 mm
<b>Weight</b>	< 10 g	< 10 g
<b>Form factor</b>	M.2 2280-D2-B-M	M.2 2280-D2-B-M
<b>Transfer rate</b>	up to 540 MB/sec	up to 540 MB/sec
<b>Interface type</b>	SATA-3	SATA-3
Ready time, maximum (to not busy)	1.0 ms	< 1.0 ms
Access times, logical	0.1 ms	0.1 ms
<b>Total logical sectors</b>	234,441,648	468,883,296
<b>Operating temperature</b>	0°C to 70°C (32°F to 158°F)	

\*1 GB = 1 billion bytes when referring to hard drive storage capacity. Actual accessible capacity is less. Actual drive specifications may differ slightly.

**NOTE:** Certain restrictions and exclusions apply. Contact technical support for details.

# 17 Statement of memory volatility

The purpose of this chapter is to provide general information regarding nonvolatile memory in HP Business PCs. This chapter also provides general instructions for restoring nonvolatile memory that can contain personal data after the system has been powered off and the hard drive has been removed.

HP Business PC products that use Intel®-based or AMD®-based system boards contain volatile DDR memory. The amount of nonvolatile memory present in the system depends upon the system configuration. Intel-based and AMD-based system boards contain nonvolatile memory subcomponents as originally shipped from HP, assuming that no subsequent modifications have been made to the system and assuming that no applications, features, or functionality have been added to or installed on the system.

Following system shutdown and removal of all power sources from an HP Business PC system, personal data can remain on volatile system memory (DIMMs) for a finite period of time and will also remain in nonvolatile memory. Use the steps below to remove personal data from the PC, including the nonvolatile memory found in Intel-based and AMD-based system boards.

---

 **NOTE:** If your tablet has a keyboard base, connect to the keyboard base before beginning steps in this chapter.

---

## Current BIOS steps

1. Follow steps (a) through (l) below to restore the nonvolatile memory that can contain personal data. Restoring or reprogramming nonvolatile memory that does not store personal data is neither necessary nor recommended.
  - a. Turn on or restart the computer, and then press **esc** while the “Press the ESC key for Startup Menu” message is displayed at the bottom of the screen.

---

 **IMPORTANT:** If the **Main** menu displays **Restore Defaults** instead of **Apply Factory Defaults and Exit**, go to [Legacy BIOS Steps on page 119](#).

---

 **NOTE:** If the system has a BIOS administrator password, enter the password at the prompt.

---

- b. Select **Main**, select **Apply Factory Defaults and Exit**, and then select **Yes** to load defaults.  
The computer will reboot.
    - c. During the reboot, press **esc** while the “Press the ESC key for Startup Menu” message is displayed at the bottom of the screen.
- d. Select the **Security** menu, select **Restore Security Settings to Factory Defaults**, and then select **Yes** to restore security level defaults.  
The computer will reboot.
      - e. During the reboot, press **esc** while the “Press the ESC key for Startup Menu” message is displayed at the bottom of the screen.

---

 **NOTE:** If the system has a BIOS administrator password, enter the password at the prompt.

---

- f. If an asset or ownership tag is set, select the **Security** menu and scroll down to the **Utilities** menu. Select **System IDs**, and then select **Asset Tracking Number**. Clear the tag, and then make the selection to return to the prior menu.

- g. If a DriveLock password is set, select the **Security** menu, and scroll down to **Hard Drive Utilities** under the **Utilities** menu. Select **Hard Drive Utilities**, select **DriveLock**, then uncheck the checkbox for **DriveLock password on restart**. Select **OK** to proceed.
  - h. Select the **Main** menu, and then select **Reset BIOS Security to factory default**. Click **Yes** at the warning message.  
The computer will reboot.
  - i. During the reboot, press **esc** while the “Press the ESC key for Startup Menu” message is displayed at the bottom of the screen.
- 
-  **NOTE:** If the system has a BIOS administrator password, enter the password at the prompt.
- j. Select the **Main** menu, select **Apply Factory Defaults and Exit**, select **Yes** to save changes and exit, and then select **Shutdown**.
  - k. Reboot the system. If the system has a Trusted Platform Module (TPM) and/or fingerprint reader, one or two prompts will appear—one to clear the TPM and the other to Reset Fingerprint Sensor; press or tap **F1** to accept or **F2** to reject.
  - l. Remove all power and system batteries for at least 24 hours.
2. Complete one of the following:
- Remove and retain the storage drive.
  - or –
  - Clear the drive contents by using a third party utility designed to erase data from an SSD.
  - or –
  - Clear the contents of the drive by using the following BIOS Setup Secure Erase command option steps:

---

 **IMPORTANT:** If you clear data using Secure Erase, it cannot be recovered.

---

- a. Turn on or restart the computer, and then press **esc** while the “Press the ESC key for Startup Menu” message is displayed at the bottom of the screen.
- b. Select the **Security** menu and scroll down to the **Utilities** menu.
- c. Select **Hard Drive Tools**.
- d. Under **Utilities**, select **Secure Erase**, select the hard drive storing the data you want to clear, and then follow the on-screen instructions to continue.

## Legacy BIOS Steps

Use the steps for older versions of BIOS.

---

 **NOTE:** If you already completed the steps in [Current BIOS steps on page 118](#), skip this section.

---

1. Follow steps (a) through (i) below to restore the nonvolatile memory that can contain personal data. Restoring or reprogramming nonvolatile memory that does not store personal data is neither necessary nor recommended.

---

 **NOTE:** If you have not already done so, access the BIOS menu.

- Turn on or restart the computer, and then press **esc** while the “Press the ESC key for Startup Menu” message is displayed at the bottom of the screen.

 **NOTE:** If the system has a BIOS administrator password, enter the password at the prompt.

---

- a. Select **Main**, select **Restore Defaults**, and then select **Yes** to load defaults.
  - b. Select the **Security** menu, select **Restore Security Level Defaults**, and then select **Yes** to restore security level defaults.
  - c. If an asset or ownership tag is set, select the **Security** menu and scroll down to the **Utilities** menu. Select **System IDs**, and then select **Asset Tracking Number**. Clear the tag, and then make the selection to return to the prior menu.
  - d. If a DriveLock password is set, select the **Security** menu, and scroll down to **Hard Drive Tools** under the **Utilities** menu. Select **Hard Drive Tools**, select **DriveLock**, then uncheck the checkbox for **DriveLock password on restart**. Select **OK** to proceed.
  - e. If an Automatic DriveLock password is set, select the **Security** menu, scroll down to **Hard Drive Tools** under the **Utilities** menu. Select **Hard Drive Tools**, scroll down to **Automatic DriveLock**, then select the desired hard drive and disable protection. At the automatic drive lock warning screen, select **Yes** to continue. Repeat this procedure if more than one hard drive has an Automatic DriveLock password.
  - f. Select the **Main** menu, and then select **Reset BIOS Security to factory default**. Click **Yes** at the warning message.
  - g. Select the **Main** menu, select **Save Changes and Exit**, select **Yes** to save changes and exit, and then select **Shutdown**.
  - h. Reboot the system. If the system has a Trusted Platform Module (TPM) and/or fingerprint reader, one or two prompts will appear—one to clear the TPM and the other to Reset Fingerprint Sensor; press or tap **F1** to accept or **F2** to reject.
  - i. Remove all power and system batteries for at least 24 hours.
2. Complete one of the following:
- Remove and retain the storage drive.
  - or –
  - Clear the drive contents by using a third party utility designed to erase data from an SSD.
  - or –
  - Clear the contents of the drive by using the following BIOS Setup Secure Erase command option steps:

 **IMPORTANT:** If you clear data using Secure Erase, it cannot be recovered.

---

- a. Turn on or restart the computer, and then press **esc** while the “Press the ESC key for Startup Menu” message is displayed at the bottom of the screen.
  - b. Select the **Security** menu and scroll down to the **Utilities** menu.
  - c. Select **Hard Drive Tools**.
  - d. Under **Utilities**, select **Secure Erase**, select the hard drive storing the data you want to clear, and then follow the on-screen instructions to continue.
- or –
- Clear the contents of the drive by using the following Disk Sanitizer command steps:

 **IMPORTANT:** If you clear data using Disk Sanitizer, it cannot be recovered.

---

 **NOTE:** The amount of time it takes for Disk Sanitizer to run can take several hours. Plug the computer into an AC outlet before starting.

---

- a. Turn on or restart the computer, and then press **esc** while the “Press the ESC key for Startup Menu” message is displayed at the bottom of the screen.
- b. Select the **Security** menu and scroll down to the **Utilities** menu.
- c. Select **Hard Drive Tools**.
- d. Under **Utilities**, select **Disk Sanitizer**, select the hard drive storing the data you want to clear, and then follow the on-screen instructions to continue.

## Nonvolatile memory usage

Nonvolatile Memory Type	Amount (Size)	Does this memory store customer data?	Does this memory retain data when power is removed?	What is the purpose of this memory?	How is data input into this memory?	How is this memory write-protected?
HP Sure Start flash (select models only)	2 MBytes	No	Yes	Provides protected backup of critical System BIOS code, EC firmware, and critical PC configuration data for select platforms that support HP Sure Start.  For more information, see <a href="#">Using HP Sure Start (select models only)</a> on page 125.	Data cannot be written to this device via the host processor. The content is managed solely by the HP Sure Start Embedded Controller.	This memory is protected by the HP Sure Start Embedded Controller.
Real Time Clock (RTC) battery backed-up CMOS configuration memory	256 Bytes	No	Yes	Stores system date and time and noncritical data.	RTC battery backed-up CMOS is programmed using the Computer Setup (BIOS), or changing the Microsoft Windows date & time.	This memory is not write-protected.
Controller (NIC) EEPROM	64 KBytes (not customer accessible)	No	Yes	Stores NIC configuration and NIC firmware.	NIC EEPROM is programmed using a utility from the NIC vendor that can be run from DOS.	A utility is required to write data to this memory and is available from the NIC vendor. Writing data to this ROM in an inappropriate manner will render the NIC non-functional.
DIMM Serial Presence Detect (SPD) configuration data	256 Bytes per memory module, 128 Bytes programmable (not customer accessible)	No	Yes	Stores memory module information.	DIMM SPD is programmed by the memory vendor.	Data cannot be written to this memory when the module is installed in a PC. The specific write-protection method varies by memory vendor.
System BIOS	4 MBytes to 5 MBytes	Yes	Yes	Stores system BIOS code and PC configuration data.	System BIOS code is programmed at the factory. Code is updated when the system BIOS is updated. Configuration data and settings are input using the Computer Setup (BIOS) or a custom utility.	<b>NOTE:</b> Writing data to this ROM in an inappropriate manner can render the PC non-functional.  A utility is required for writing data to this memory and is available on the HP website; go to <a href="http://www.hp.com/support">http://www.hp.com/support</a> , and select your country. Select <b>Drivers &amp;</b>

Nonvolatile Memory Type	Amount (Size)	Does this memory store customer data?	Does this memory retain data when power is removed?	What is the purpose of this memory?	How is data input into this memory?	How is this memory write-protected?
Intel Management Engine Firmware (present in only specific ZBook and EliteBook models. For more information, go to <a href="http://www.hp.com/support">http://www.hp.com/support</a> , and select your country. Select <b>Drivers &amp; Downloads</b> , and then follow the on-screen instructions.)	1.5 MBytes or 5 MBytes	Yes	Yes	Stores Management Engine Code, Settings, Provisioning Data and iAMT third-party data store.	Management Engine Code is programmed at the factory. Code is updated via Intel secure firmware update utility. Unique Provisioning Data can be entered at the factory or by an administrator using the Management Engine (MEBx) setup utility. The third party data store contents can be populated by a remote management console or local applications that have been registered by an administrator to have access to the space.	<b>Downloads</b> , and then follow the on-screen instructions.  The Intel chipset is configured to enforce hardware protection to block all direct read/write access to this area. An Intel utility is required for updating the firmware. Only firmware updates digitally signed by Intel can be applied using this utility.
Bluetooth flash	2 Mbit	No	Yes	Stores Bluetooth configuration and firmware.	Bluetooth flash is programmed at the factory. Tools for writing data to this memory are not publicly available but can be obtained from the silicon vendor.	A utility is required for writing data to this memory and is made available through newer versions of the driver whenever the flash requires an upgrade.
802.11 WLAN EEPROM	4 Kbit to 8 Kbit	No	Yes	Stores configuration and calibration data.	802.11 WLAN EEPROM is programmed at the factory. Tools for writing data to this memory are not made public.	A utility is required for writing data to this memory and is typically not made available to the public unless a firmware upgrade is necessary to address a unique issue.
Web camera	64 Kbit	No	Yes	Stores webcam configuration and firmware.	Webcam memory is programmed using a utility from the device manufacturer that can be run from Windows.	A utility is required for writing data to this memory and is typically not made available to the public unless a firmware upgrade is necessary to address a unique issue.
Fingerprint reader	512 KByte flash	Yes	Yes	Stores fingerprint templates.	Fingerprint reader memory is programmed by user enrollment in HP ProtectTools Security Manager.	Only a digitally signed application can make the call to write to the flash.

## Questions and answers

### 1. How can the BIOS settings be restored (returned to factory settings)?



**IMPORTANT:** Restore defaults does not securely erase any data on your hard drive. See question and answer 6 for steps to securely erase data.

Restore defaults does not reset the Custom Secure Boot keys. See question and answer 7 for information about resetting the keys.

- a. Turn on or restart the computer, and then press **esc** while the “Press the ESC key for Startup Menu” message is displayed at the bottom of the screen.
- b. Select **Main**, and then select **Restore defaults**.
- c. Follow the on-screen instructions.
- d. Select **Main**, select **Save Changes and Exit**, and then follow the on-screen instructions.

### 2. What is a UEFI BIOS, and how is it different from a legacy BIOS?

The Unified Extensible Firmware Interface (UEFI) BIOS is an industry-standard software interface between the platform firmware and an operating system (OS). It is a replacement for the older BIOS architecture, but supports much of the legacy BIOS functionality.

Like the legacy BIOS, the UEFI BIOS provides an interface to display the system information and configuration settings and to change the configuration of your computer before an OS is loaded. BIOS provides a secure run-time environment that supports a Graphic User Interface (GUI). In this environment, you can use either a pointing device (Touchscreen, TouchPad, pointing stick, or USB mouse) or the keyboard to navigate and make menu and configuration selections. The UEFI BIOS also contains basic system diagnostics.

The UEFI BIOS provides functionality beyond that of the legacy BIOS. In addition, the UEFI BIOS works to initialize the computer’s hardware before loading and executing the OS; the run-time environment allows the loading and execution of software programs from storage devices to provide more functionality, such as advanced hardware diagnostics (with the ability to display more detailed system information) and advanced firmware management and recovery software.

HP has provided options in Computer Setup (BIOS) to allow you to run in legacy BIOS, if required by the operating system. Examples of this requirement would be if you upgrade or downgrade the OS.

### 3. Where does the UEFI BIOS reside?

The UEFI BIOS resides on a flash memory chip. A utility is required to write to the chip.

### 4. What kind of configuration data is stored on the DIMM Serial Presence Detect (SPD) memory module? How would this data be written?

The DIMM SPD memory contains information about the memory module, such as size, serial number, data width, speed/timing, voltage, and thermal information. This information is written by the module manufacturer and stored on an EEPROM. This EEPROM cannot be written to when the memory module is installed in a PC. Third-party tools do exist that can write to the EEPROM when the memory module is not installed in a PC. Various third-party tools are available to read SPD memory.

### 5. What is meant by “Restore the nonvolatile memory found in Intel-based system boards”?

This message relates to clearing the Real Time Clock (RTC) CMOS memory that contains PC configuration data.

### 6. How can the BIOS security be reset to factory defaults and data erased?



---

 **IMPORTANT:** Resetting will result in the loss of information.

These steps will not reset Custom Secure Boot Keys. See question and answer 7 for information about resetting the keys.

---

- a. Turn on or restart the computer, and then press **esc** while the “Press the ESC key for Startup Menu” message is displayed at the bottom of the screen.
- b. Select **Main**, and then select **Reset BIOS Security to Factory Default**.
- c. Follow the on-screen instructions.
- d. Select **Main**, select **Save Changes and Exit**, and then follow the on-screen instructions.

#### 7. How can the Custom Secure Boot Keys be reset?

Secure Boot is a feature to ensure that only authenticated code can start on a platform. If you enabled Secure Boot and created Custom Secure Boot Keys, simply disabling Secure Boot will not clear the keys. You must also select to clear the Custom Secure Boot Keys. Use the same Secure Boot access procedure you used to create the Custom Secure Boot Keys, but make the selection to clear or delete all Secure Boot Keys.

- a. Turn on or restart the computer, and then press **esc** while the “Press the ESC key for Startup Menu” message is displayed at the bottom of the screen.
- b. Select the **Security** menu, select **Secure Boot Configuration**, and then follow the on-screen instructions.
- c. At the **Secure Boot Configuration** window, select **Secure Boot**, select **Clear Secure Boot Keys**, and then follow the on-screen instructions to continue.

## Using HP Sure Start (select models only)

Select computer models are configured with HP Sure Start, a technology that continuously monitors your computer's BIOS for attacks or corruption. If the BIOS becomes corrupted or is attacked, HP Sure Start restores the BIOS to its previously safe state, without user intervention. Those select computer models ship with HP Sure Start configured and enabled. HP Sure Start is configured and already enabled so that most users can use the HP Sure Start default configuration. The default configuration can be customized by advanced users.

To access the latest documentation on HP Sure Start, go to <http://www.hp.com/support>, and select your country. Select **Drivers & Downloads**, and then follow the on-screen instructions.

# 18 Power cord set requirements

The wide-range input feature of the computer permits it to operate from any line voltage from 100 to 120 volts ac, or from 220 to 240 volts ac.

The 3-conductor power cord set included with the computer meets the requirements for use in the country or region where the equipment is purchased.

Power cord sets for use in other countries and regions must meet the requirements of the country or region where the computer is used.

## Requirements for all countries and regions

The following requirements are applicable to all countries and regions:

- The length of the power cord set must be at least **1.5 m** (5.0 ft) and no more than **2.0 m** (6.5 ft).
- All power cord sets must be approved by an acceptable accredited agency responsible for evaluation in the country or region where the power cord set will be used.
- The power cord sets must have a minimum current capacity of 10 A and a nominal voltage rating of 125 or 250 V ac, as required by the power system of each country or region.
- The appliance coupler must meet the mechanical configuration of an EN 60 320/IEC 320 Standard Sheet C13 connector for mating with the appliance inlet on the back of the computer.

## Requirements for specific countries and regions

Country/region	Accredited agency	Applicable note number
Argentina	IRAM	1
Australia	SAA	1
Austria	OVE	1
Belgium	CEBEC	1
Brazil	ABNT	1
Canada	CSA	2
Chile	IMQ	1
Denmark	DEMKO	1
Finland	FIMKO	1
France	UTE	1
Germany	VDE	1
India	ISI	1
Israel	SII	1
Italy	IMQ	1

Country/region	Accredited agency	Applicable note number
Japan	JIS	3
The Netherlands	KEMA	1
New Zealand	SANZ	1
Norway	NEMKO	1
The People's Republic of China	CCC	4
Saudi Arabia	SASO	7
Singapore	PSB	1
South Africa	SABS	1
South Korea	KTL	5
Sweden	SEMKO	1
Switzerland	SEV	1
Taiwan	BSMI	6
Thailand	TISI	1
The United Kingdom	ASTA	1
The United States	UL	2

1. The flexible cord must be Type H05VV-F, 3-conductor, 0.75mm<sup>2</sup> conductor size. Power cord set fittings (appliance coupler and wall plug) must bear the certification mark of the agency responsible for evaluation in the country or region where it will be used.
2. The flexible cord must be Type SVT/SJT or equivalent, No. 18 AWG, 3-conductor. The wall plug must be a two-pole grounding type with a NEMA 5-15P (15 A, 125 V ac) or NEMA 6-15P (15 A, 250 V ac) configuration. CSA or C-UL mark. UL file number must be on each element.
3. The appliance coupler, flexible cord, and wall plug must bear a "T" mark and registration number in accordance with the Japanese Dentori Law. The flexible cord must be Type VCTF, 3-conductor, 0.75mm<sup>2</sup> or 1.25mm<sup>2</sup> conductor size. The wall plug must be a two-pole grounding type with a Japanese Industrial Standard C8303 (7 A, 125 V ac) configuration.
4. The flexible cord must be Type RVV, 3-conductor, 0.75mm<sup>2</sup> conductor size. Power cord set fittings (appliance coupler and wall plug) must bear the CCC certification mark.
5. The flexible cord must be Type H05VV-F 3X0.75mm<sup>2</sup> conductor size. KTL logo and individual approval number must be on each element. Corset approval number and logo must be printed on a flag label.
6. The flexible cord must be Type HVCTF 3X1.25mm<sup>2</sup> conductor size. Power cord set fittings (appliance coupler, cable, and wall plug) must bear the BSMI certification mark.
7. For 127 V ac, the flexible cord must be Type SVT or SJT 3 x 18 AWG, with plug NEMA 5-15P (15 A, 125 V ac), with UL and CSA or C-UL marks. For 240 V ac, the flexible cord must be Type H05VV-F 3X0.75/1.00mm<sup>2</sup> conductor size, with plug BS 1363/A with BSI or ASTA marks.

---

# 19 Recycling

When a non-rechargeable or rechargeable battery has reached the end of its useful life, do not dispose of the battery in general household waste. Follow the local laws and regulations in your area for battery disposal.

HP encourages customers to recycle used electronic hardware, HP original print cartridges, and rechargeable batteries. For more information about recycling programs, see the HP Web site at <http://www.hp.com/recycle>.

# Index

## A

- AC adapter, spare part numbers 25
- antennas
  - disconnecting 39
- audio, product description 2
- audio-out (headphone)/audio-in (microphone) combo jack, identifying 7

## B

- backup 110
- Backup and Restore 98
- backup tools 96
- backups 104
  - creating 97
  - recovering 98
- base enclosure, spare part number 21
- battery
  - spare part number 21, 33
- battery connector cable
  - removal 59
  - spare part number 59
- battery cover, identifying 15
- battery light 7
- battery release latch 15
- BIOS
  - determining version 76, 81, 88, 92
  - downloading an update 77, 82, 88, 93
  - updating 76, 81, 88, 92

- Bluetooth card
  - spare part number 39
- Bluetooth label 17
- boot order
  - changing 108
- bottom 17
- buttons
  - left TouchPad 10
  - power 12
  - right TouchPad 10

## C

- Cable Kit
    - contents 23
    - spare part number 23
  - cables, service considerations 28
  - caps lock light, identifying 11
  - chipset, product description 1
  - components
    - bottom 15
    - display 9
    - left side 7
    - right side 6
    - top 10
  - computer reset 112
  - Computer Setup
    - navigating and selecting 75, 80, 86, 91
    - restoring factory settings 76, 81, 87, 92
  - computer setup
    - navigating and selecting 91
    - restoring factory settings 92
  - computer specifications 114
  - connector, power 7
  - connectors, service considerations 28
- ## D
- diskette drive
    - precautions 28
  - display assembly
    - removal 69
    - spare part numbers 69
  - display bezel
    - removal 70
    - spare part numbers 22
  - display components, spare part numbers 22
  - display hinge
    - removal 72
  - Display Hinge Kit
    - spare part numbers 22
  - display panel
    - product description 1

- display rear cover
  - spare part number 22
- display specifications 115
- Driver Recovery DVD,
  - creating 96
  - using for restore 99
- drives
  - preventing damage 28

## E

- electrostatic discharge 29
- embedded numeric keypad, identifying 14
- esc key, identifying 14
- Ethernet, product description 2
- external media cards, product description 3
- external monitor port 6

## F

- f11 recovery 99, 102
- fan
  - removing 57
  - spare part number 20
- fingerprint reader assembly
  - removal 51
  - spare part number 20, 51
- fingerprint reader, identifying 13
- fn key, identifying 14
- function board
  - removal 54
  - spare part number 20, 54
- function keys, identifying 14

## G

- graphics, product description 1
- grounding equipment and methods 31

## H

- hard drive
  - precautions 28
  - product description 2
  - removing 35

- spare part numbers 21, 24, 35
    - specifications 116
  - hard drive hardware kit
    - spare part number 21
- Hard Drive Hardware Kit, spare part number 24
- hard drive light, identifying 8
- hard drive recovery 99, 102
- hard drive, identifying 15
- HDMI port, identifying 6
- heat sink
  - removal 66
  - spare part number 20, 66
- hinge
  - removal 72
- HP PC Hardware Diagnostics (UEFI)
  - using 94
- HP Recovery Disc Creator, using 96
- HP Recovery Manager
  - correcting boot problems 108
  - starting 107
- HP Recovery media
  - creating 104
  - recovery 107
- HP Recovery partition
  - checking for presence 99
  - recovery 107
  - removing 109
  - using for recovery 99
- HP Sure Start 125

**I**

- integrated webcam light, identifying 9
- internal microphones, identifying 9

**J**

- jacks
  - audio-out (headphone)/audio-in (microphone) combo 7
  - network 6
  - RJ-45 (network) 6

**K**

- keyboard
  - product description 3
  - removal 42
  - spare part numbers 20, 42
- keypad
  - embedded numeric 14

- keys
  - esc 14
  - fn 14
  - function 14
  - Windows application 14
  - Windows key 14

**L**

- labels
  - Bluetooth 17
  - regulatory 17
  - serial number 17
  - service 17
  - wireless certification 17
  - WLAN 17
- latch, battery release 15
- legacy support, USB 75, 80, 86, 91
- lights
  - battery 7
  - caps lock 11
  - hard drive 8
  - microphone mute 11
  - num lock 11
  - power 11
  - RJ-45 (network) 6
  - TouchPad 11
  - webcam 9
  - wireless 11

**M**

- M.2 solid-state drive
  - removal 41
  - spare part number 41
- mass storage devices, spare part numbers 24
- memory
  - nonvolatile 118
  - volatile 118
- memory card reader, identifying 8
- memory module
  - identifying 15
  - product description 1
  - removal 37
  - spare part numbers 21, 37
- microphone (audio-in) jack
  - product description 2
- microphone module
  - spare part number 22
- microphone mute light, identifying 11

- mini card
  - product description 2
- minimized image recovery 107
- minimized image, creating 106
- model name 1

**N**

- network jack, identifying 6
- nonvolatile memory 118
- num lock light 11

**O**

- operating system, product description 4
- optical drive
  - precautions 28
  - product description 2
- original system recovery 106

**P**

- packing guidelines 30
- plastic parts 27
- Plastics Kit
  - contents 23
  - spare part number 23
- pointing device, product description 3
- ports
  - external monitor 6
  - HDMI 6
  - product description 3
  - USB 2.0 charging (powered) 7
- power button board assembly
  - removal 53
  - spare part number 20, 53
- power button, identifying 12
- power cable
  - removal 74
  - spare part number 21, 74
- power connector, identifying 7
- power cord
  - set requirements 126
  - spare part numbers 25
- power lights 11
- power requirements, product description 3
- processor
  - product description 1
- product description
  - audio 2
  - chipset 1

- display panel 1
  - Ethernet 2
  - external media cards 3
  - graphics 1
  - hard drives 2
  - keyboard 3
  - memory module 1
  - microphone 2
  - mini card 2
  - operating system 4
  - optical drive 2
  - pointing devices 3
  - ports 3
  - power requirements 3
  - processors 1
  - product name 1
  - security 4
  - serviceability 5
  - webcam 2
  - wireless 2
  - product name 1
  - product name and number, computer 17
- R**
- recover
    - options 106
  - recovery 103, 110
    - discs 105, 107
    - HP Recovery Manager 106
    - media 107
    - starting 107
    - supported discs 105
    - system 106
    - USB flash drive 107
    - using HP Recovery media 105
  - recovery media
    - creating 104
    - creating using HP Recovery Manager 105
  - recovery media, creating 96
  - recovery media, using for restore 99
  - recovery partition 99, 102
    - removing 109
  - recovery tools 96
  - recovery tools, Windows 98
  - recovery, system 98
  - refresh 103
- R**
- regulatory information
    - regulatory label 17
    - wireless certification labels 17
  - removal/replacement
    - preliminaries 27
    - procedures, Authorized Service Provider 47
    - procedures, Customer Self-Repair 32
  - removing personal data from volatile system memory 118
  - reset 103
    - computer 112
    - steps 112
  - restoring the hard drive 99, 102
  - RJ-45 (network) jack, identifying 6
  - RJ-45 (network) lights, identifying 6
  - RTC battery
    - removal 63
    - spare part number 21, 63
- S**
- Screw Kit, spare part number 26
  - security cable slot, identifying 6
  - security, product description 4
  - serial number 17
  - serial number, computer 17
  - service considerations 27
  - service door
    - spare part number 21, 34
  - service labels, locating 17
  - serviceability, product description 5
  - setup utility
    - navigating and selecting 75, 80, 86
    - restoring factory settings 76, 81, 87
  - slots
    - security cable 6
  - solid-state drive
    - removal 41
    - spare part number 41
    - spare part numbers 21, 24
    - specifications 117
  - speaker assembly
    - removal 64
    - spare part number 21, 64
  - speakers, identifying 13
- S**
- specifications
    - computer 114
    - display 115
    - hard drive 116
    - solid-state drive 117
  - Startup Repair, using 98
  - static-shielding materials 31
  - supported discs, recovery 105
  - Sure Start
    - using 79, 85, 90
  - system board
    - removal 60
    - spare part numbers 20, 60
  - system memory, removing personal data from volatile 118
  - system recovery 106
  - system restore point
    - creating 105
  - system restore point, creating 104
- T**
- thermal material, replacement 67, 68
  - tools required 27
  - top cover
    - removal 47
    - spare part number 20, 47
  - TouchPad
    - buttons 10
  - TouchPad light, identifying 11
  - TouchPad zone
    - identifying 10
  - TPM settings 89
  - transporting guidelines 30
  - traveling with the computer 17
- U**
- Ubuntu
    - remove everything and reinstall option 112
  - USB 2.0 charging (powered) port, identifying 7
  - USB 3.0 port 6
  - USB legacy support 75, 80, 86, 91
  - USB ports, identifying 6
  - USB/audio/card reader board
    - removal 55
    - spare part number 20, 55
- V**
- vents, identifying 7, 15

## W

- webcam 9
  - product description 2
- webcam light, identifying 9
- webcam module
  - removal 71
  - spare part number 22
- webcam, identifying 9
- Windows
  - Refresh 103
  - Reset 103
  - system restore point 104, 105
- Windows 7 operating system DVD
  - creating 96
  - using for restore 99
- Windows 7 operating system media
  - creating 96
  - using for restore 99
- Windows application key,  
identifying 14
- Windows key, identifying 14
- Windows operating system DVD  
103
- Windows Startup Repair, using 98
- Windows tools
  - using 105
- wireless antennas
  - disconnecting 39
- wireless antennas, identifying 9
- wireless certification label 17
- wireless light 11
- wireless, product description 2
- WLAN antennas, identifying 9
- WLAN device 17
- WLAN label 17
- WLAN/Bluetooth combo card
  - removal 39
  - spare part number 21, 39
- workstation guidelines 30
- WWAN antennas, identifying 9