

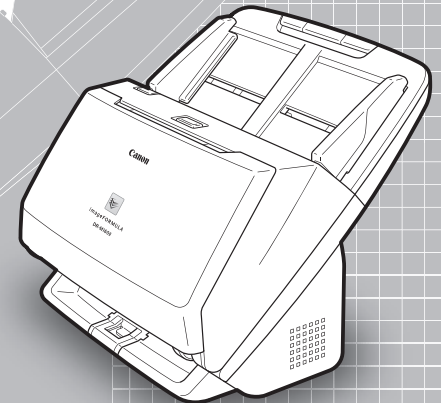

User Manual

- Please read this manual before operating this scanner.
- After you finish reading this manual, store it in a safe place for future reference.



FCC REGULATIONS (For 120 V model)

Document Scanner, Model M111092

This device complies with Part 15 of the FCC Rules. Operation is subject to the following two conditions: (1) This device may not cause harmful interference, and (2) this device must accept any interference received, including interference that may cause undesired operation.

Note: This equipment has been tested and found to comply with the limits for a Class B digital device, pursuant to Part 15 of the FCC Rules. These limits are designed to provide reasonable protection against harmful interference in a residential installation. This equipment generates, uses, and can radiate radio frequency energy and, if not installed and used in accordance with the instructions, may cause harmful interference to radio communications. However, there is no guarantee that interference will not occur in a particular installation. If this equipment does cause harmful interference to radio or television reception, which can be determined by turning the equipment OFF and ON, the user is encouraged to try to correct the interference by one or more of the following measures:

- Reorient or relocate the receiving antenna.
- Increase the separation between the equipment and receiver.
- Connect the equipment into an outlet on a circuit different from that to which the receiver is connected.
- Consult the dealer or an experienced radio/TV technician for help.

Use of shielded cable is required to comply with Class B limits in Subpart B of Part 15 of FCC Rules.

Do not make any changes or modifications to the equipment unless otherwise specified in the manual. If such changes or modifications should be made, you could be required to stop operation of the equipment.

Canon U.S.A. Inc.

ONE CANON PARK, MELVILLE, NY 11747, U.S.A.

Tel. No. (800)652-2666

RADIO INTERFERENCE REGULATIONS (For 120 V models)

This digital apparatus does not exceed the Class B limits for radio noise emissions from digital apparatus as set out in the interference-causing equipment standard entitled "Digital Apparatus", ICES-003 of the Industry Canada.

RÈGLEMENT SUR LE BROUILLAGE RADIOÉLECTRIQUE (For 120 V models)

Cet appareil numérique respecte les limites de bruits radioélectriques applicables aux appareils numériques de Classe B prescrites dans la norme sur le matériel brouilleur: "Appareils Numériques", NMB-003 édictée par l'Industrie Canada.

International ENERGY STAR® Office Equipment Program



As an ENERGY STAR® Partner, CANON ELECTRONICS INC. has determined that this machine meets the ENERGY STAR® Program guidelines for energy efficiency.

The International ENERGY STAR® Office Equipment Program is an international program that promotes energy saving through the use of computers and other office equipment. The program backs the development and dissemination of products with functions that effectively reduce energy consumption. It is an open system in which business proprietors can participate voluntarily. The targeted products are office equipment, such as computers, monitors, printers, fax, machine, copiers, and scanners. The standards and logos are uniform among participating nations. This model doesn't provide setting options for power management.

European Union (and EEA) only.



This symbol indicates that this product is not to be disposed of with your household waste, according to the WEEE Directive (2002/96/EC) and your national law. This product should be handed over to a designated collection point, e.g., on an authorized one-for-one basis when you buy a new similar product or to an authorized collection site for recycling waste electrical and electronic equipment (EEE). Improper handling of this type of waste could have a possible negative impact on the environment and human health due to potentially hazardous substances that are generally associated with EEE. At the same time, your cooperation in the correct disposal of this product will contribute to the effective usage of natural resources. For more information about where you can drop off your waste equipment for recycling, please contact your local city office, waste authority, approved WEEE scheme or your household waste disposal service. For more information regarding return and recycling of WEEE products, please visit www.canon-europe.com/environment. (EEA: Norway, Iceland and Liechtenstein)

Für EMVG

Dieses Produkt ist zum Gebrauch im Wohnbereich, Geschäfts- und Gewerbebereich sowie in Kleinbetrieben vorgesehen.

Model Names

The following name may be provided for the safety regulations in each sales region of the Document Scanner.

DR-M160II: Model M111092

Trademarks

- Canon and the Canon logo are registered trademarks, of Canon Inc. in the United States and may also be trademarks or registered trademarks in other countries.
- imageFORMULA is a trademark of CANON ELECTRONICS INC.
- Microsoft, Windows, Windows Vista, PowerPoint, and SharePoint are registered trademarks or trademarks of Microsoft Corporation in the United States and other countries.
- Microsoft product screen shot(s) reprinted with permission from Microsoft Corporation.
- OS X is a trademark of Apple Inc., registered in the U.S. and other countries.
- ENERGY STAR® is a registered trademark of the United States Environmental Protection Agency.
- ISIS is a registered trademark of Emc Corporation in the United States.
- Copyright © 1995-2011 Nuance Communications, Inc. All rights reserved. eCopy is a trademark and/or registered trademarks of Nuance Communications, Inc. and/or its affiliates in the United States and/or other countries.
- Adobe, the Adobe logo, Acrobat, the Adobe PDF logo, and Adobe Reader are either registered trademarks or trademarks of Adobe Systems Incorporated in the United States and/or other countries.



Powered by
ADOBE® PDF LIBRARY

- Other product and company names herein may be the trademarks of their respective owners. However, the ™ and ® symbols are not used in this document.

Copyright

Copyright 2014 by CANON ELECTRONICS INC. All rights reserved. No part of this publication may be reproduced or transmitted in any form or by any means, electronic or mechanical, including photocopying and recording, or by any information storage or retrieval system without the prior written permission of CANON ELECTRONICS INC.

Disclaimers

The information in this document is subject to change without notice.

CANON ELECTRONICS INC. MAKES NO WARRANTY OF ANY KIND WITH REGARD TO THIS MATERIAL, EITHER EXPRESS OR IMPLIED, EXCEPT AS PROVIDED HEREIN, INCLUDING WITHOUT LIMITATION, THEREOF, WARRANTIES AS TO MARKETABILITY, MERCHANTABILITY, FITNESS FOR A PARTICULAR PURPOSE OF USE OR NON-INFRINGEMENT. CANON ELECTRONICS INC. SHALL NOT BE LIABLE FOR ANY DIRECT, INCIDENTAL, OR CONSEQUENTIAL DAMAGES OF ANY NATURE, OR LOSSES OR EXPENSES RESULTING FROM THE USE OF THIS MATERIAL.

CANON ELECTRONICS INC. IS NOT LIABLE FOR THE STORAGE AND HANDLING OF DOCUMENTS SCANNED WITH THIS PRODUCT, OR THE STORAGE AND HANDLING OF RESULTING SCANNED IMAGE DATA.

IF YOU INTEND TO DISCARD THE ORIGINALS OF SCANNED DOCUMENTS, YOU THE CUSTOMER ARE RESPONSIBLE FOR INSPECTING THE SCANNED IMAGES AND VERIFYING THAT DATA IS INTACT.

THE MAXIMUM LIABILITY OF CANON ELECTRONICS INC. UNDER THIS WARRANTY IS LIMITED TO THE PURCHASE PRICE OF THE PRODUCT COVERED BY THE WARRANTY.

STEP 1

Checking the Accessories

If any of the items listed below are missing or damaged, contact your local authorized Canon dealer or service representative.

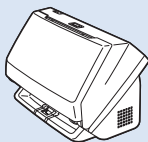

Scanner

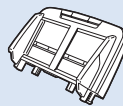

Feed Tray

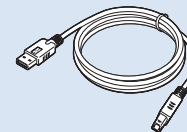

USB Cable
Type A/Type B (Length: 1.8 m)

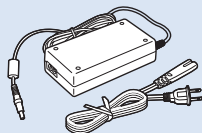

AC Adapter/Power Cord
(Connected length: 2.6 m)



Setup Guide



Setup Disc

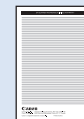

Warranty Card
(U.S.A. and Canada only)

- Items included in this manual are subject to change without notice.
- You must keep the machine's packaging and packing materials for storing or transporting the machine.
- For Europe, a print version of *Reference Guide* is supplied in English.
The content of the *Reference Guide* can be found in other languages in the *User Manual* on the Setup Disc.
- The shape of the power plug varies by country and region.

Setup Disc Contents

Install the following software necessary for using the scanner from the supplied Setup Disc.

- **CaptureOnTouch**

This is a dedicated scanning application for this product.

- **CapturePerfect 3.1**

This is a scanning application for the DR series scanner.

- **Scanner Driver**

This is the scanner driver for this product.

Third-Party Software

The following software applications are also included on the supplied Setup Disc. For details on installing these applications, refer to the Readme.txt file.

- **eCopy PDF Pro Office (Windows only)**

Nuance Communications PDF creation/editing software.

! IMPORTANT

When scanning with third-party software, use the scanner driver of this scanner to configure scanning conditions. For details on how to open the scanner driver, refer to the manuals supplied with each software application.

After taking the scanner out of the box, install the feed tray and remove the protective sheets (▼).

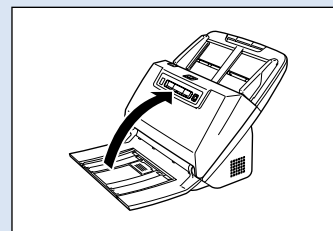
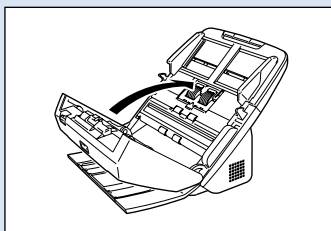
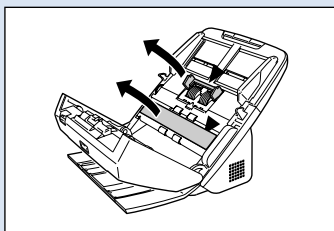
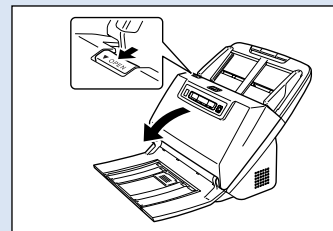
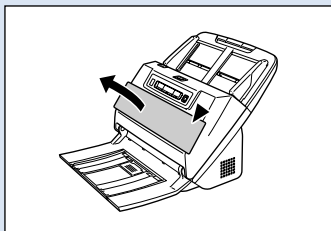
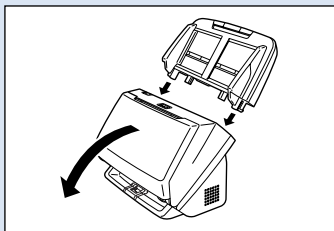

System requirements

To use the scanner, your computer must satisfy the following system requirements.

Computer

CPU:	Intel Core 2 Duo 1.66GHz or faster
Memory:	1 GB or more
Hard disk:	3 GB or more available space required for installation of all software
USB interface:	Hi-Speed USB2.0
Monitor:	Resolution of 1024 x 768 (XGA) or better recommended.
Optical drive:	Drive capable of reading DVDs.

Operating system

- Microsoft Windows XP Service Pack 3 or later
- Microsoft Windows XP x64 Edition Service Pack 2 or later
- Microsoft Windows Vista Service Pack 2 or later (32-bit and 64-bit editions)
- Microsoft Windows 7 Service Pack 1 or later (32-bit and 64-bit editions)
- Microsoft Windows 8 or 8.1 (32/64-bit version)
- Microsoft Windows Server 2008 R2 Service Pack 1 or later
- Microsoft Windows Server 2012 R2
- OS X 10.7.5, 10.8.5, or 10.9.1

Other requirements

- An ISIS-compatible application (Windows only) or a TWAINcompatible application that is compatible with the above operating systems.
- .NET Framework 3.5 or later (Windows only)



IMPORTANT

- Use the USB interface provided as standard with your computer. However, normal operation is not guaranteed with all USB interfaces, even if present as standard equipment on the computer. For details, consult your local authorized Canon dealer.
- Scanning speeds are lower if your computer's standard USB interface is USB Full-Speed (equal to USB 1.1.)

- The USB cable you are using should be the one originally included with the scanner.
- If the CPU, memory, interface card, and other specifications do not satisfy the installation requirements, the scanning speed may be greatly reduced and transmission may take a long time.
- Even if the computer satisfies the system requirements, the scanning speed may vary, depending on the specification of the computer and the environment.
- The scanner drivers provided with the scanner do not necessarily operate on all ISIS (only for Windows) or TWAIN-compatible applications. For details, contact your application software retailer.

Precautions for Use in 64-bit Operating Systems

- The ISIS/TWAIN driver supplied with this product supports scanning with 32bit applications only.
- Even with 32-bit applications, not all ISIS/TWAIN compliant applications are guaranteed to operate.
- Scanning speed may vary depending on the specifications of your computer.

Software Installation

→ Windows

→ Mac

Windows

! IMPORTANT

- Install the software before connecting the scanner to the computer.
- Log on to Windows as an Administrator.
- Close all other applications before installing the software.

1 Insert the Setup Disc into the DVD drive of the computer.

The setup menu automatically starts up when you insert the disc into the drive. (If the menu does not start up, execute setup.exe from the disc.)

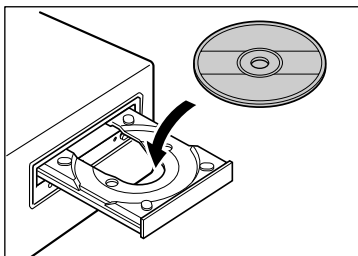

For Windows 8.1/8/7/Vista

If the following screen appears, click [Yes] or [Permissions].

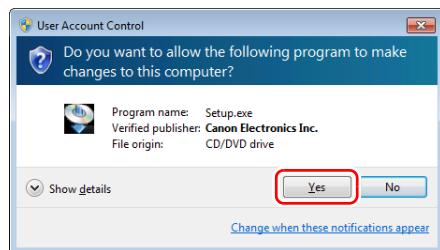

2 Click [Typical Installation].

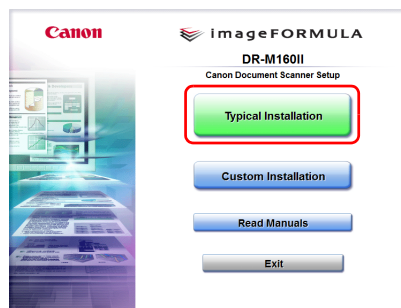

About Installation of the Third-Party Software

When installing the bundled software, you can choose which of the bundled software to install if you select [Custom Installation].

💡 Hint

If you want to reinstall only specific software that you have previously uninstalled, select [Custom Installation] and specify the software.

3 Click [Install].

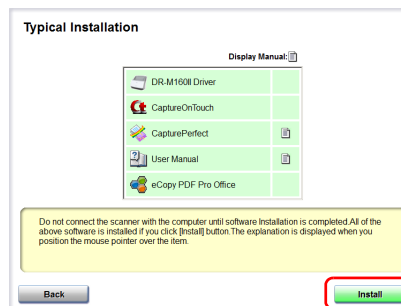

4 Follow the instructions on the screen to complete installation.

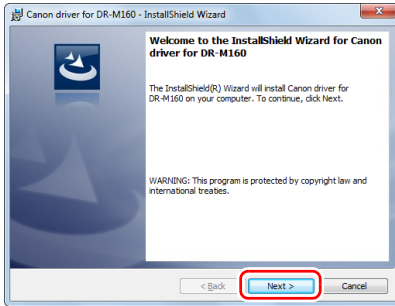

5 Click [Exit] to finish installing the software.



Mac

! IMPORTANT

- Install the software before connecting the scanner to the computer.
- Close all other applications before installing the software.

1 Insert the Setup Disc into the DVD drive of the computer.

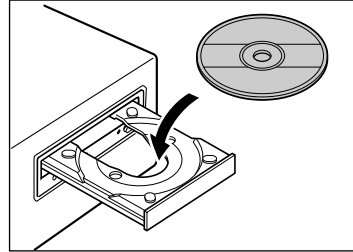

2 Click [DR-M160 Installer].

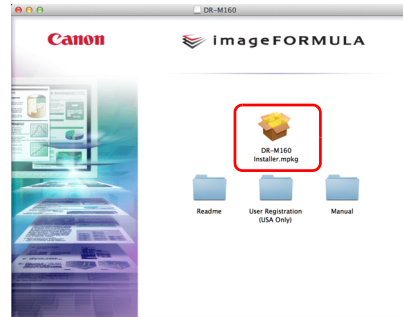

About Installation of Third-Party Software

If you open the folder containing the software instead of selecting [DR-M160 Installer], you can choose third-party software applications for installation.

3 Follow the instructions on the screen to complete installation.

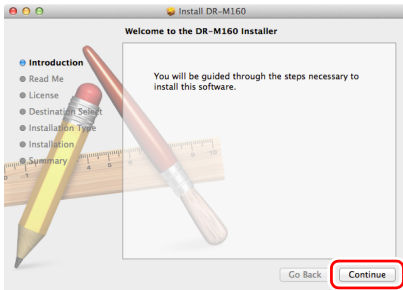

4 When the installation is complete, click [Log out].

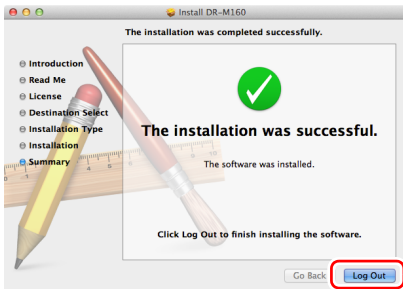

STEP 3

Connecting to a Computer

Connect the scanner to the computer and the power supply.

! IMPORTANT

- Do not connect the scanner to the computer before installing the software.
- Before connecting the scanner to the computer, verify that the power of the scanner is OFF.
If the power is ON, turn it OFF.

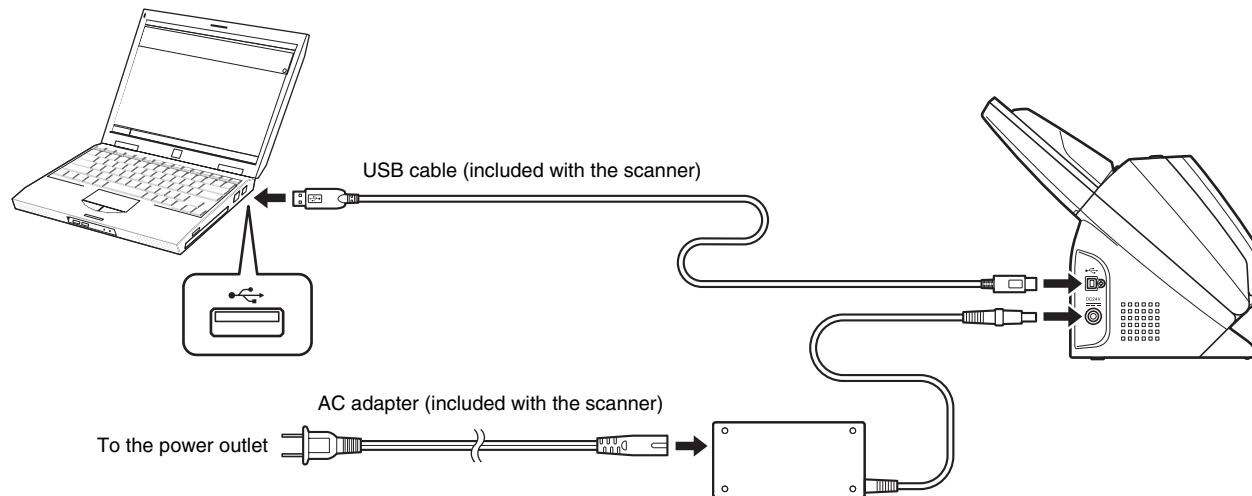

STEP 4

Turning the Power ON

The power of the scanner can be turned ON and OFF with the power button on the front of the scanner.

- 1 Make sure that the scanner and computer are connected properly.
- 2 Press the power button.

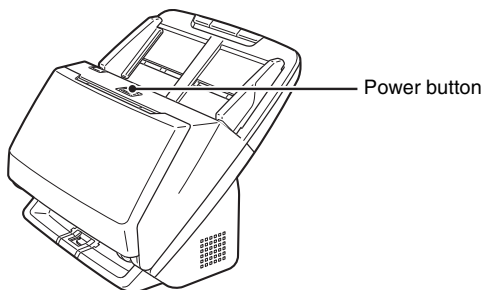



The power button lights blue when the power turns ON.

Windows

Hint

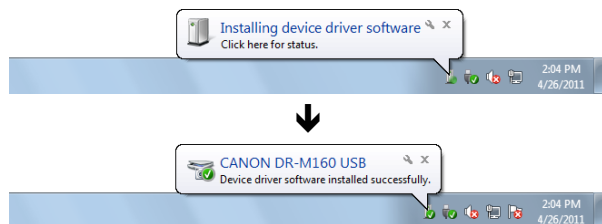
A balloon message such as shown below appears on the task bar. If you wait a while, automatic scanner recognition will end and the scanner will become ready to use.



When the scanner is properly connected to the computer, the  (CaptureOnTouch) icon appears on the taskbar as follows.



If the taskbar icon appears as , the scanner is not properly connected to the computer. Check the status of the power switch and USB cable.

Mac

When the scanner is properly connected to the computer, the  (CaptureOnTouch) icon appears on the taskbar as follows.



If the taskbar icon appears as , the scanner is not properly connected to the computer. Check the status of the power switch and USB cable.

Turning Off the Power

Press and hold the power button until the indicator goes out.

! IMPORTANT

- After turning the scanner off, wait at least 10 seconds before turning it back on.
- If you will not be using the scanner for an extended period, you should disconnect the power cord from the AC outlet for safety.

Hint

The scanner's auto power off setting is enabled by default, and the scanner will turn off automatically if it is not operated for 4 hours. For details on how to disable this setting, see "Auto Power Off Setting" on p. 90.

This completes setup.

Introduction

Thank you for purchasing the Canon imageFORMULA DR-M160II Document Scanner.

Please read the following manuals carefully and familiarize yourself with the functions of the scanner before use to ensure you sufficiently understand the functions and make the most of the scanner's capabilities. After reading the manuals, store them in a safe place for future reference.

Manuals for the Scanner

In DR-M160II driver and application software, the product name appears as DR-M160.

Documentation for this scanner consists of the following manuals.

● Setup Guide

This describes setup procedures for the scanner. Read this manual when you first use the scanner.

● User Manual (this manual)

This manual contains the operating procedures of the scanner. (PDF electronic manual only)

Windows

Hint

- The manual (User Manual) for this scanner is stored on the Setup Disc as an electronic manual in PDF format.
- If you are using Windows, the User Manual (electronic manual) will be registered to the following location when the software is installed.

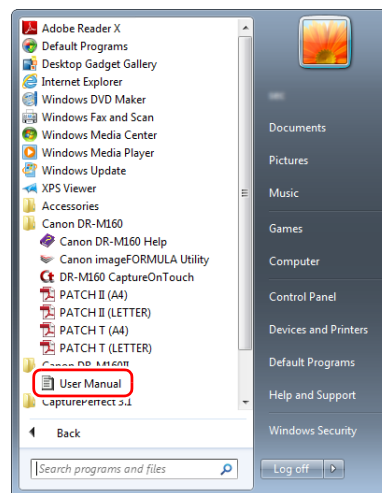

Hint

In Windows 8.1/8, it is registered at the following location.

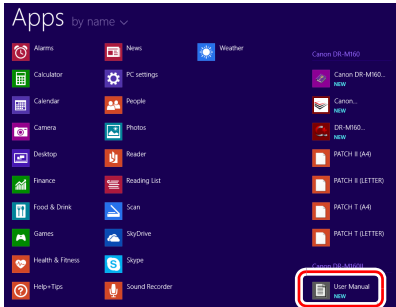

Symbols Used in This Manual

The following symbols are used in this manual to explain procedures, restrictions, handling precautions, and instructions that should be observed for safety.

WARNING

Indicates a warning concerning operations that may lead to death or injury to persons if not performed correctly. To use the scanner safely, always pay attention to these warnings.

CAUTION

Indicates a caution concerning operations that may lead to injury to persons, or damage to property if not performed correctly. To use the scanner safely, always pay attention to these cautions.

IMPORTANT

Indicates operational requirements and restrictions. Be sure to read these items carefully to operate the scanner correctly, and avoid damaging the scanner.

Hint

Indicates a clarification of an operation, or contains additional explanations for a procedure. Reading these notes is highly recommended.

Table of Contents

Setup Guide	4	Setting the Scanner Driver	57
Introduction	12	Configuration and Functions of the Scanner Driver	57
Symbols Used in This Manual	13	Setting Basic Scanning Conditions	60
Before Using the Scanner	15	More Advanced Scanning Methods (Batch Separation)	77
Important Safety Instructions	15	Batch Separation (Insert blank page).....	77
Installation Location	15	Batch Separation	77
AC Adapter.....	15	Maintenance	80
Moving the Scanner	16	Daily Maintenance	80
Handling	16	Cleaning the Scanner.....	80
Disposal	17	Cleaning the Inside of the Scanner	80
When sending the scanner for repairs	17	Cleaning the Sensor Glass and the Rollers	80
Features of the Scanner	18	Adjusting the Reduction Ratio.....	83
Names and Functions of Parts	20	Replacing Consumable Parts.....	85
Basic Operation	23	Auto Power Off Setting.....	90
Documents	23	Removing the Document Feed Tray	91
How to Place Documents	25	Troubleshooting	92
Scanning multiple documents	25	Common Problems and Solutions	92
When scanning a document one page at a time (non separation mode)	26	Software Troubleshooting	95
Placing Thin Paper (Thin Paper Mode).....	28	Useful tips	96
Placing Cards.....	29	Clearing a Paper Jam	98
Placing Folded Documents	30	Uninstalling the Software	100
Setting the Long Document Mode.....	32	Appendix	101
Detecting a document double feed	34	Specifications	101
Double Feed Retry	37	Replacement parts	102
Scanning methods	38	Option.....	102
Scanning with CaptureOnTouch	38	About the Flatbed Scanner Unit 101/Flatbed Scanner Unit 201 102	
What is CaptureOnTouch?.....	38	Dimensions.....	103
Starting and Exiting CaptureOnTouch	38	Index	104
Scan First.....	40		
Select Scan Job	42		
Operating the scanner with the operating panel buttons.....	45		
Scanner Settings.....	45		
Setting the Output Method	49		
Environmental Settings	51		
Scanning with CapturePerfect	55		
Scanning with CapturePerfect.....	55		

Before Using the Scanner

Important Safety Instructions

To ensure the safe operation of this scanner, be sure to read the safety warnings and precautions described below.

Installation Location

The performance of this scanner is affected by the environment in which it is installed. Make sure that the location where the scanner is installed meets the following environmental requirements.

- Provide adequate space around the scanner for operation, maintenance, and ventilation.

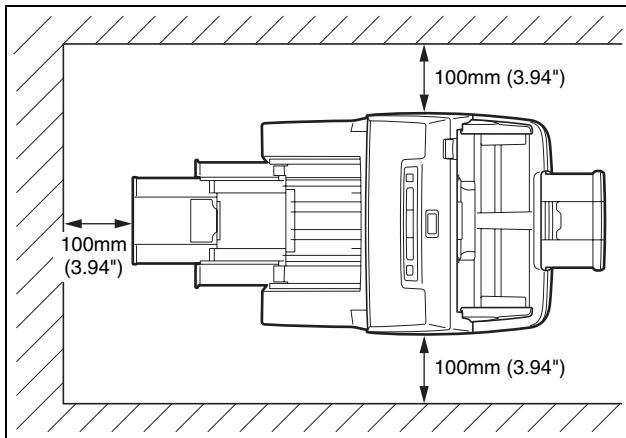

- Provide adequate space in front of the scanner for documents output after being scanned.
- Avoid installing the machine in direct sunlight. If this is unavoidable, use curtains to shade the scanner.
- Avoid locations where a considerable amount of dust accumulates as dust may adversely affect the inside of the scanner.
- Avoid warm or humid locations, such as in the vicinity of a water faucet, water heater, or humidifier. Avoid locations where ammonia gas is emitted. Avoid locations near volatile or flammable materials, such as alcohol or paint thinner.
- Avoid locations that are subject to vibration.

- Avoid exposing the scanner to rapid changes in temperature. If the room in which the scanner is installed is cold but rapidly heated, water droplets (condensation) may form inside the scanner. This may result in a noticeable degradation in scanning quality. The following conditions are recommended for optimal scanning quality:
Room temperature: 10 °C to 32.5 °C (50 °F to 90.5 °F)
Humidity: 20% to 80% RH
- Avoid installing the scanner near equipment that generates a magnetic field (e.g. speakers, televisions, or radios.)

AC Adapter

- Connect only to a power outlet of the rated voltage and power supply frequency (120 V, 60 Hz or 220-240 V, 50/60 Hz depending on your region).
- Do not connect other electrical equipment to the same power outlet to which the scanner is connected. Also, when using an extension cord, make sure that the extension cord is rated for the current requirements of the scanner.
- Never try to take the AC adapter apart or modify it in any way, as this is dangerous.
- The power cord may become damaged if it is often stepped on or if heavy objects are placed on it.
- Do not use the power cord while it is coiled.
- Do not pull directly on the power cord. When disconnecting the power cord, grasp the plug and remove it from the outlet.
- Keep the area around the power cord clear of objects so that the power cord can be disconnected easily in an emergency.
- Do not use an AC adapter other than the one provided with the scanner. Do not use the AC adapter provided with the scanner with other products.
- If you have any questions regarding the power supply, contact your local authorized Canon dealer or service representative for further information.

Moving the Scanner

- When moving the scanner, always hold it with both hands to avoid dropping it.
- Make sure to disconnect the interface cable and AC adapter before moving the scanner. If the scanner is transported with these items connected, the plugs and connectors may be damaged.

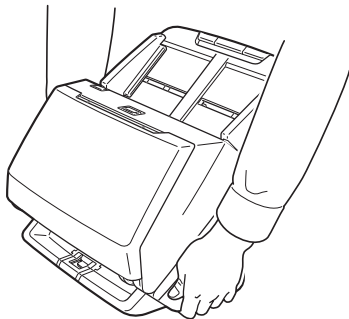

Handling

WARNING

Note the following precautions whenever using the scanner. Failure to do so may result in a fire or electric shock.

- Never use alcohol, benzene, paint thinner, aerosol sprays, or any other highly flammable substance near the scanner.
- Do not cut, damage, or modify the power cord. Do not place heavy objects on the power cord, and do not pull or excessively bend the power cord.
- Never connect the power cord when your hands are wet.
- Do not connect the scanner to a multi plug power strip.
- Do not knot or coil the power cord as this may result in a fire or electric shock. When connecting the power cord, make sure that the power plug is securely and completely inserted into the power outlet.
- Do not use a power cord or AC adapter other than the ones provided with this scanner.
- Do not take the scanner apart or modify it.

- Never try to take the AC adapter apart or modify it in any way, as this is dangerous.
- Do not use flammable spray near the scanner.
- When cleaning the scanner, push the power button to turn it OFF and disconnect the power cord from the power supply.
- Clean the scanner using a slightly dampened cloth which has been well wrung out. Never use alcohol, benzene, paint thinner, or any other flammable substances.
- If the scanner makes strange noises, or gives off smoke, heat, or strange odors, or the scanner does not function or other abnormalities occur when you use the machine, immediately push the power button to turn it off, and disconnect the power plug from the power outlet. Then, contact your local authorized Canon dealer or service representative to have the unit serviced.
- Do not drop the scanner, or subject it to impact or strong shock. Should the scanner ever become damaged, immediately push the power button to turn it OFF, and disconnect the power plug from the power outlet. Then, contact your local authorized Canon dealer or service representative to have the unit serviced.
- Before moving the scanner, be sure to push the power button to turn it OFF, and disconnect the power plug from the power outlet

CAUTION

- Do not install the scanner on a surface that is unstable or tilted, or in an area subject to excessive vibrations, as this may cause the scanner to fall, resulting in personal injury or damage to the scanner.
- Never place small metal objects such as staples, paper clips, or jewelry on the scanner. These items may fall into the scanner, and cause a fire or electric shock. Should such objects ever fall inside the scanner, immediately push the power button to turn it OFF, and disconnect the power plug from the power outlet. Then, contact your local authorized Canon dealer or service representative to have the unit serviced.
- Do not install the scanner in a humid or dusty location. Doing so might cause a fire or electric shock.
- Do not place objects on top of the scanner. Such objects may tip or fall over, resulting in personal injury.
- Connect only to a power outlet of the rated voltage and power supply frequency (120 V, 60 Hz or 220-240 V, 50/60 Hz depending on your region). Doing so might cause a fire or electric shock.

-
- When unplugging the power cord, grasp it firmly by its plug. Do not pull directly on the power cord, as this may damage or expose the cord's internal wiring, resulting in a fire or electric shock.
 - Leave sufficient space around the power plug so that it can be unplugged easily. If objects are placed around the power plug, you will be unable to unplug it in an emergency.
 - Do not allow water or flammable substances (alcohol, paint thinner, benzene, etc.) to spill into the scanner, as this may result in a fire or electric shock. Doing so might cause a fire or electric shock.
 - Push the power button to turn the scanner OFF for safety when not using the scanner for a long period of time, such as overnight. Also, push the power switch to turn it OFF, and disconnect the power cord from the power outlet for safety when the machine will not be used for an extended period of time, such as during consecutive holidays.
 - Do not wear loose clothing or jewelry that may get caught in the scanner while you are using it, as this may result in personal injury. Be extra careful of neckties and long hair. If anything becomes caught in the scanner, immediately disconnect the power cord to stop the scanner.
 - Be careful when loading paper into the scanner and when removing jammed paper, as it is possible to cut your hand on the edge of a sheet of paper.

Disposal

When disposing of this scanner, be sure to follow all local ordinances and laws or consult with the retailer who sold you the scanner.

When sending the scanner for repairs

When a request is made for repairs, the scanner needs to be sent to the specified address. When sending the scanner, use the packing box in which it came. Firmly secure the scanner with packaging material when you place it in the packing box.

Features of the Scanner

The main features of the DR-M160II document scanner are described below.

● **Compact Design**

The scanner has a compact size of 280 mm (11.02")(W) x 250 mm (9.84")(D) x 230 mm (9.06")(H) when the document feed is closed.

● **Fast Document Feeding**

Documents can be scanned at a speed of up to 60 pages per minute (when scanning one-sided or two-sided documents of A4 size at 200 dpi).

● **High Image Quality**

The 600 dpi optical resolution sensor incorporated in the scanner enables documents to be scanned with high image quality.

● **USB 2.0 Interface**

The scanner supports Hi-Speed USB 2.0.

● **Color/Grayscale Support**

Documents can be scanned in 24-bit color or 256-level grayscale.

● **Supports a Variety of Scanning Modes**

The scanner supports the following scanning modes, depending on the document type:

- Single-sided or double-sided scanning (with Skip Blank Page function)
- Continuous or single sheet feed

● **Card Scan**

You can scan business or ID cards.

● **Paper Size Detection**

The scanner automatically detects the size of a scanned document and eliminates any unnecessary space around the edges of the image when storing the image, even when storing a document of irregular size.

● **Auto Color Detection**

The scanner detects whether the scanned document is in color, grayscale, or black and white, and saves the image accordingly.

● **Full Auto Mode**

A Full Auto Mode is provided in CaptureOnTouch to allow scanning under automatically determined conditions. Scanning conditions such as the color mode and page size are set automatically based on the document being scanned.

● **Auto Resolution Detection**

When enabled in the CaptureOnTouch or scanner driver settings, this function detects the content of documents and determines the scanning resolution automatically.

● **Folio Scan**

You can scan folded documents. The scanner will scan both sides and combine the scanned images into a single image.

● **Deskew**

The scanner straightens scanned images when it detects that the document was placed askew.

● **Ultrasonic Double Feed Detection**

Ultrasonic waves are used to detect pages that are fed at the same time as well as the space between pages. Scanning stops if a double feed is detected.

● **Double Feed Detection Ignore**

When a double feed is detected, the DFR button on the operation panel is lit. You can continue scanning by pressing the DFR button.

● **Double Feed Retry**

When a double feed has occurred, this function returns the document to the document feeder and re-feeds the pages.

● **Text Enhancement Modes**

The scanner is equipped with an Advanced Text Enhancement Mode to enhance the text of documents with dark or uneven backgrounds, and an Advanced Text Enhancement II mode to enhance the text when both the text and background are light. These modes may not work, depending on the type of document.

● **Color Drop-out**

The scanner is equipped with a Color Drop-out function that enables you to specify a color for the scanner to omit from the scanned image during black and white or grayscale scanning.

● **Skip Blank Page Function**

The scanner is equipped with a Skip Blank Page function that enables you to scan a document without storing images of blank pages, regardless of whether each page of the document is two-sided or one-sided. Both sides are scanned, but saving the image is skipped for scan images judged to be from a blank page.

- **Prescan Function**

The scanner is equipped with a Prescan function that allows you to adjust the contrast and brightness of a prescanned image and then send the adjusted image to the application software, without needing to scan the document again.

- **Character/Line Emphasis Function**

If characters and lines in scanned images are not clearly visible, you can use this function to adjust their thickness during scanning.

- **Start Scanning from the Operating Panel**

You can start scanning by launching CaptureOnTouch with the operating panel buttons. By default, Job No.1 is assigned to Scan First, which allows you to easily scan a document by just following the instructions on the screen.

- **Auto Start**

The scanner is equipped with an auto start function, which enables scanning to be automatically started when a document placed in the feeder is detected.

- **Sleep Mode**

The scanner is designed to save energy by automatically entering the sleep mode if 10 minutes elapse without scanning or another operation being performed.

**Hint**

Some functions may not be available depending on the software you are using.

Names and Functions of Parts

Front View (With the Eject Tray Closed)

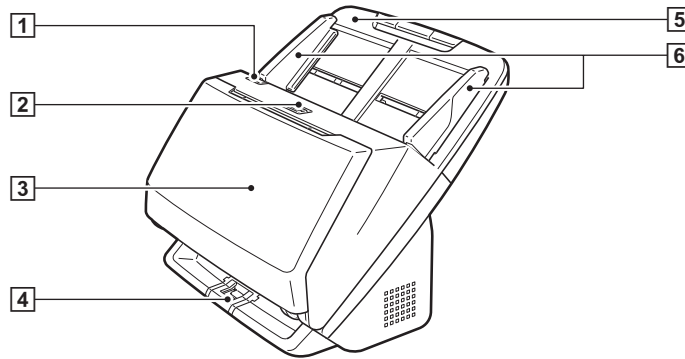

1 OPEN Lever

Pull this toward you to open the front unit.

2 Power button

Press this to turn on the scanner. When pressed, the power indicator is lit.

Press this button again to turn off the power.

The power button lights or flashes as follows depending on the scanner status.

Power Button Indication	Description
Lit	Power is on
Flashing (slowly)	Sleep mode
Flashing (quickly)	An error (paper jam, front unit is open, double feed, etc.) has occurred

3 Document Eject Tray

Open this for scanning. Scanned documents are output here.

4 Eject Tray Support

Open this when scanning multiple documents of varying sizes at one time. Scanned documents are arranged in the tray by supporting and lifting up the document eject tray from the bottom.

5 Document Feed Tray

Place the document.

6 Document Guides

Align the document guides with both edges of the document to ensure that the document feeds straightly.

Front View (With the Eject Tray Open)

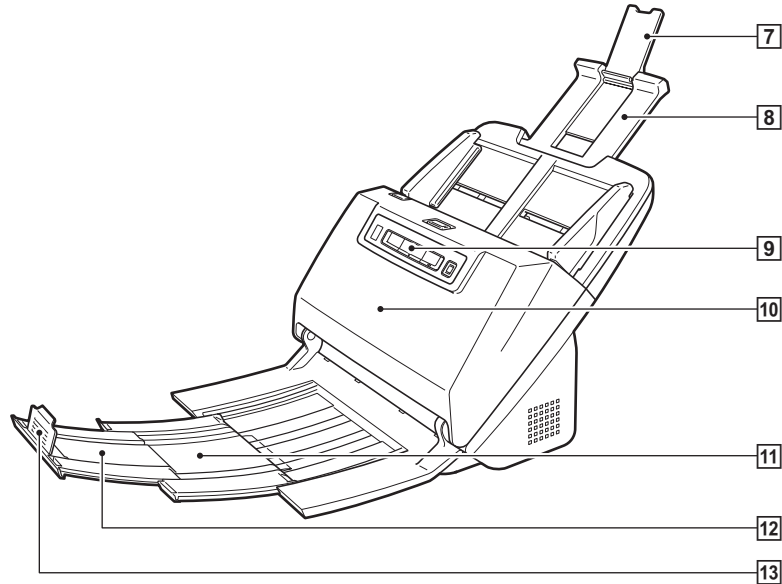

7 Feed Extension Support

Open this when placing long paper in the scanner.

8 Feed Support

Pull this out to support loaded documents.

9 Operating Panel

A range of scanning operations can be performed with this, such as starting and stopping scans, executing registered jobs, and cancelling double feed detection. (See p. 22)

10 Front Unit

Open this when cleaning the inside of the scanner or replacing rollers.

11 Eject Support

Open this when loading long documents.

12 Document Eject Extension Support

If required, pull this out to match the length of loaded documents.

13 Document Eject Stopper

This prevents the document coming out of the document eject tray and aligns the leading edges of the ejected document. It can be moved to any position on the document eject extension support to match the length of the document.

Back View

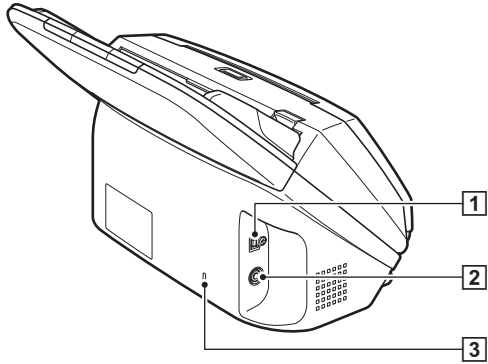

1 USB Connector

Connect the supplied USB cable to this connector.

2 Power Connector

Connect the supplied AC adapter to this connector.

3 Theft Prevention Hole (Security Slot)

Connect an anti-theft key chain or the like.

Operating Panel

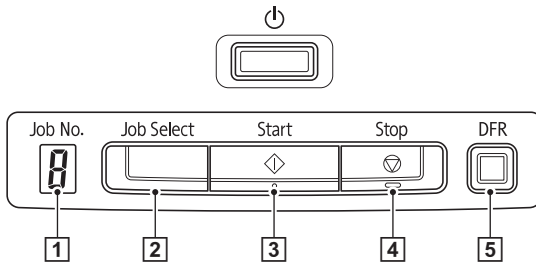

1 Job No. Indicator

Displays the number of the job selected with the operating panel.

2 Job Select Button

This selects registered jobs. Every time the button is pressed, the Job No. displayed in the Job No. Indicator changes.

3 Start Button

This executes the job displayed in the Job No. Indicator.

4 Stop Button

This stops active jobs.

5 DFR Button

This is lit when a document double feed is detected. Pressing this button cancels the double feed detection function, allowing you to continue scanning.

Displayed Error Codes

When a scanning error occurs, the following error codes are displayed in the Job No. Indicator.



: displayed when the front unit is open.



: displayed when a paper jam is detected.



: displayed when a double feed is detected while scanning.



: displayed for other errors.

Documents

The scanner can scan documents ranging in size from business cards to LTR/A4. The document sizes that this scanner can scan are shown below.

Plain Paper

Size

Width: 54 mm to 216 mm (2.12" to 8.5")

Length: 50.8 mm to 356 mm (2" to 14") (You can scan documents up to 3,000 mm (118.1") long by setting the scanner to the Long Document mode.)

Paper thickness

Normal feed: 27 to 209 g/m² (7 to 56 lb bond) 0.04 mm to 0.25 mm (0.00157" to 0.00984")

Non separation feed: 27 to 255 g/m² (7 to 68 lb bond) 0.04 mm to 0.3 mm (0.00157" to 0.0118")

Loading capacity

A4 size or smaller: 60 sheets (80g/m² (21 lb bond))

Larger than A4 size: 40 sheets (80g/m² (21 lb bond))

Make sure stacks do not exceed 10 mm in height (including curls) for either of the above.

! IMPORTANT

The documents to be scanned must satisfy certain criteria. Read the following items carefully.

- When scanning multiple documents of different sizes, place the documents so that they cover the entire span of the feed rollers by aligning the centers and leading edges of the documents.

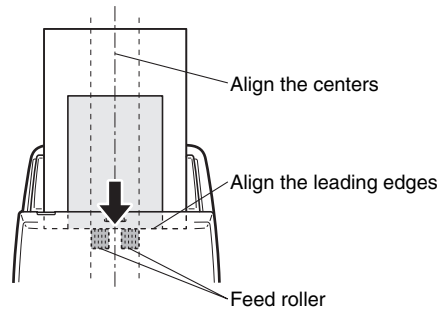

- It is recommended that documents exceeding 356 mm (14") size are fed one sheet at a time.
- Scanning documents before the ink is dry can cause problems with the scanner. Always make sure that the ink on a document is dry before scanning it.
- Scanning documents that are written in pencil or similar material may make the rollers and scanning glass dirty, which can lead to smudges on the scanned image and transfer the dirt to subsequent documents. Always clean the internal parts of the scanner after scanning such documents.
- When scanning a two-sided document that is printed on thin paper, the image on the opposite side of each page may show through. In this case, adjust the scanning intensity in the application software before scanning the document.
- When the paper of the document is thin, switch to thin paper mode and then feed the document. For details, see "Placing Thin Paper (Thin Paper Mode)" on p. 28.
- Laminated documents may not be scanned correctly, depending on the document.

-
- Scanning the following types of documents can cause a paper jam or malfunction. To scan such a document, make a photocopy of the document and then scan the photocopy.



There are creases or fold lines.



Carbon paper



There are curls.



The surface is coated.



There are tears.



Extremely thin document such as semi-transparent thin paper.



There are clips or staples.



Documents with excessive paper dust particles.

Business Card

Size: 50.8 mm x 85 mm (2" x 3.35") or larger
Paper thickness: 380 g/m² (80 lb bond) 0.45 mm (0.177") or larger
Orientation: Vertical feeding only

! IMPORTANT

- We recommend placing business cards horizontally. Vertically placed business cards may not feed properly depending on their size.
- If a stack of business cards cannot be fed properly, reduce the number of cards in the stack.

Card (plastic)

Size: 54 mm x 86 mm (2.12" x 3.37") (ISO standard)
Card thickness: 1.4 mm (0.055") or smaller
Orientation: Horizontal feeding only
Embossed cards can be scanned.
Loading capacity: 3 cards (non-embossed), 1 card (embossed)

! CAUTION

- When scanning cards, place them to be fed horizontally. If you place cards to be fed vertically, they may not be ejected properly, and cards that get jammed may be damaged when you remove them.
- Embossed cards may not be able to be scanned correctly, depending on the type of embossment.

How to Place Documents

Scanning multiple documents

Standard paper feeding should be used when scanning multiple documents of a standard size at one time. Standard paper feeding enables multiple documents to be fed while separating each page.

- 1 Open the document eject tray.

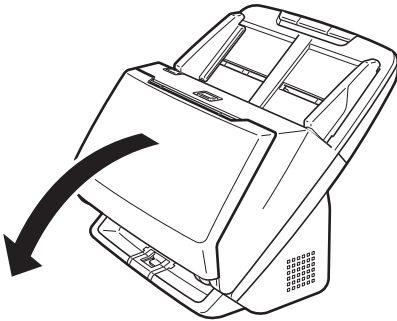

- 2 Pull out the eject support.

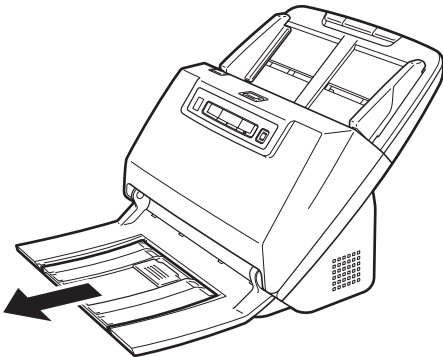

When placing long documents, pull out the document eject extension support to match the length of those documents. Also, stand the eject stopper at the end of the eject support if necessary.

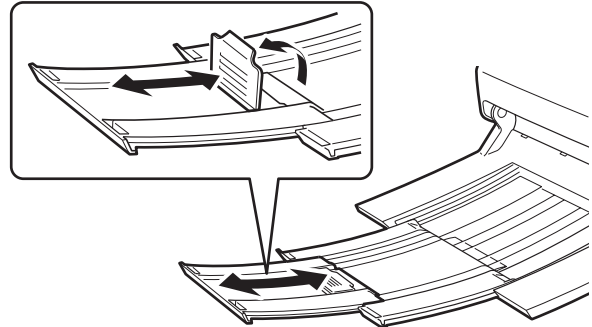

! IMPORTANT

Pull out the eject support and document eject extension support.

- 3 Pull out the feed support.

Open the feed extension support when placing long documents.

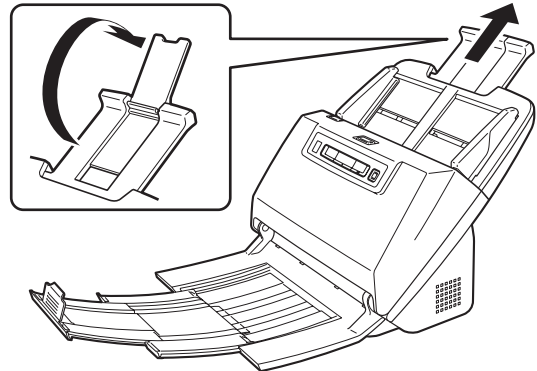

4 Adjust the document guides to fit the width of the document to be scanned.

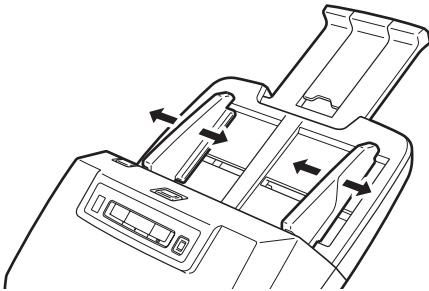

5 Place the document.

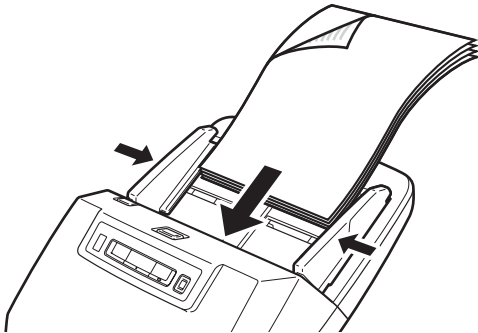

After placing the document, align the document guides with both edges of the document.

! IMPORTANT

- When placing documents into the feed tray, take care not to cut your hand on the edges of the paper.
- Make sure that the document does not exceed the loading limit marks (▼) on the document guides. Up to 60 pages of ordinary plain paper (80 g/m²) can be loaded at the same time.

- Before you place a document, check to make sure it does not contain paper clips, staples, or other small metal objects. These items may cause a fire or electrical shock, damage the document, or cause a paper jam or scanner malfunction.
- Do not wear loose clothing or jewelry that may get caught in the scanner while you are using it, as this may result in personal injury. Be extra careful of neckties and long hair. If anything gets caught in the scanner, immediately turn OFF the power switch, and disconnect the power cord from the power outlet to stop scanning.
- Always smooth out any folds or curls in your documents before placing them into the feeder. If the leading edge of a document is curled, it may cause a paper jam.
- If feeding stops due to a system error or paper jam while the scanner is scanning, resolve the problem, make sure that the scanned image of the last page that was successfully fed has been stored, and then resume scanning the remaining document pages.
- After you finish scanning, close the document eject tray to prevent damage to the scanner while it is not being used.

When scanning a document one page at a time (non separation mode)

When scanning a thick document one page at a time or scanning a document that has multiple pages fastened together, set document feeding to non separation mode. This enables the placed document to be scanned without the pages being separated, regardless of the number of pages.

Non separation mode switching is performed by opening the scanner driver settings screen.

1 Sets the scanning conditions.

→ **Windows**

→ **Mac**

-
- 2 Place the document as described in the “[Scanning multiple documents](#)” procedure on p. 25.

! IMPORTANT

When scanning multiple page documents that are fastened together, such as invoices, place the documents so that the edge that is fastened together is facing down.

Windows

- 1 Opens the scanner driver's Detail Settings screen. (See p. 57)
- 2 Open the [Feeding] Tab.
- 3 Select the [Non Separation Feeding Mode] check box.

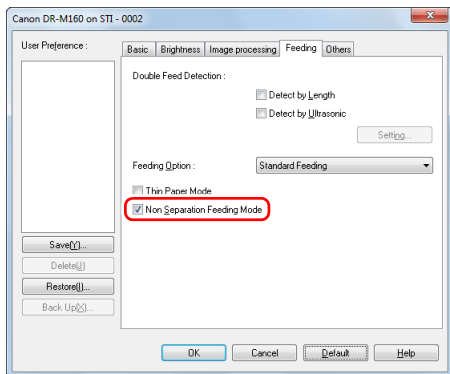

- 4 Click the [OK] button to close the settings screen.

Mac

- 1 Opens the scanner driver's Detail Settings screen. (See p. 47)
- 2 Click the [More] button.
The scanner driver's Detail Settings screen opens.
- 3 Select the [Non Separation Feeding Mode] check box.

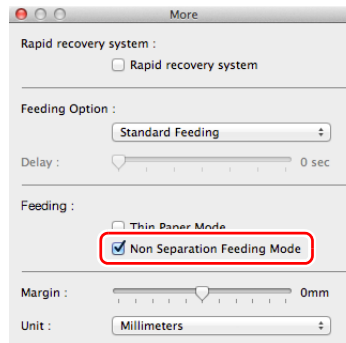

- 4 Click  to close the dialog box.

Placing Thin Paper (Thin Paper Mode)

When placing a document with thin paper, switch the mode of the scanner to thin paper mode. In thin paper mode, the placed document is fed in a manner that prevents it from being damaged. Thin paper mode switching is performed by opening the scanner driver settings screen.

1 Sets the scanning conditions.

→ **Windows**

→ **Mac**

2 Place the document as described in the “Scanning multiple documents” procedure on p. 25.



Hint

- When scanning multiple page documents that are fastened together, such as invoices, select the [Non Separation Feeding Mode] check box in step 4. Also, it is recommended to place the documents in the scanner one at a time with the edge that is fastened together facing down.
- When scanning multiple documents of different sizes, the scanned documents may not be ejected neatly onto the document eject tray. When scanning such documents, open the eject tray support.

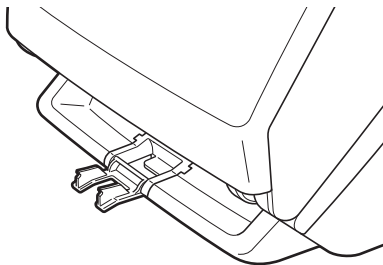

Windows

- 1 Opens the scanner driver's Detail Settings screen. (See p. 57)
- 2 Open the [Feeding] tab.
- 3 Select the [Thin Paper Mode] check box.

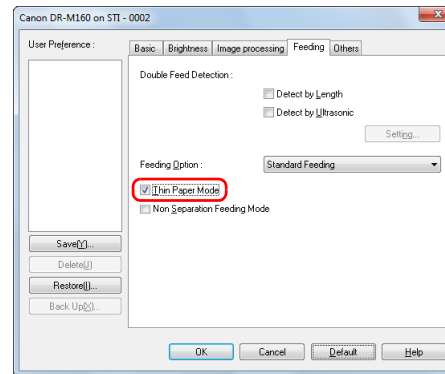

- 4 Click the [OK] button to close the settings screen.

Mac

- 1 Opens the scanner driver's Detail Settings screen. (See p. 47)
- 2 Click the [More] button.
The scanner driver's Detail Settings screen opens.

3 Select the [Thin Paper Mode] check box.

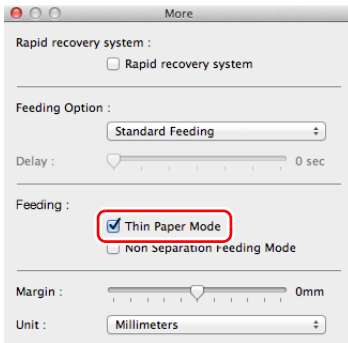

4 Click to close the dialog box.

Placing Cards

When scanning cards, switch the scanner to non separation mode and then place one card at a time horizontally.

1 Switch the scanner to non separation mode.

2 Adjust the document guides to fit the width of the card to be scanned.

3 Place the card horizontally, with the reverse side facing you, and the top of the card facing down.

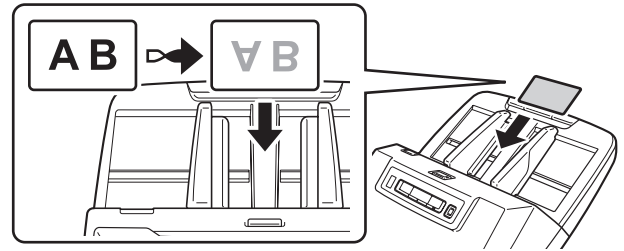

CAUTION

- Place the cards one at a time.
- When scanning cards, place them to be fed horizontally. If you place cards to be fed vertically, they may not be ejected properly, and cards that get jammed may be damaged when you remove them.

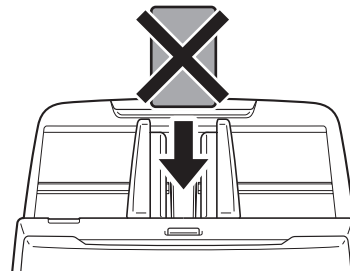

Hint

Up to 3 cards can be placed in the scanner at the same time if they are not embossed. In such a case, turn off non separation mode before scanning.

Placing Folded Documents

Folio Scan enables you to scan documents that are larger than LTR/A4 and therefore do not fit in the feeder. To use the function, fold the document in half lengthwise and place it into the feeder. The DR-M160II will scan both sides and combine the scanned images into a single image.

1 Sets the scanning conditions.

→ **Windows**

→ **Mac**

2 Fold the document in half.

Crease the document firmly down its center to fold the document in half. Fold the document so that its edges are neatly aligned. If the document is not folded properly, paper jams may occur or distortions may appear in the combined scanned image.

! IMPORTANT

A portion of the scanned image will be missing at the fold line.

3 Place the document with the folded edge facing right and the top edge facing downward.

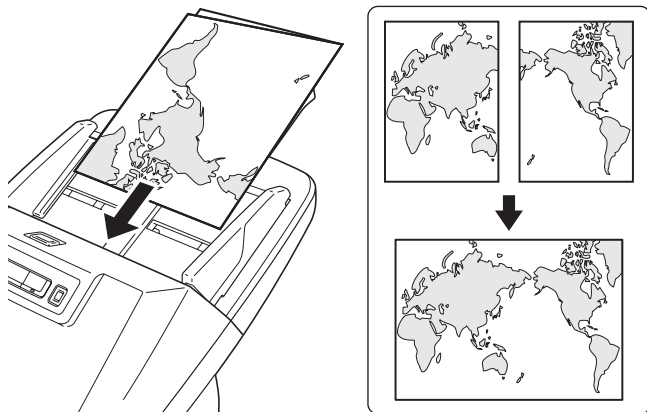

! IMPORTANT

Adjust the document guides to fit the width of the document. Otherwise, the image may scan as skewed or shifted.

💡 Hint

- The side of the folded document facing you will become the right side of the combined image.
- The maximum size for the combined image is A2. Use this method to scan A2-sized documents. When scanning a folded document of a size other than the standard formats, set [Page Size] on the scanner driver settings screen to [Match original size]. (See p. 60)

Windows

1 Opens the scanner driver's Detail Settings screen. (See p. 57)

2 Set [Page Size] on the [Basic] tab to a size that is half that of the paper to be actually scanned, and set [Scanning Side] to [Folio].

For example, when scanning a document of A3 size folded, set [Page Size] to [A4].

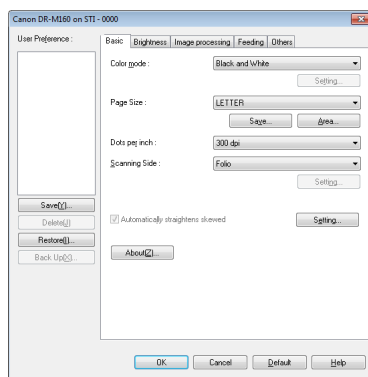

3 Open the [Feeding] tab.

4 Select the [Non Separation Feeding Mode] check box.

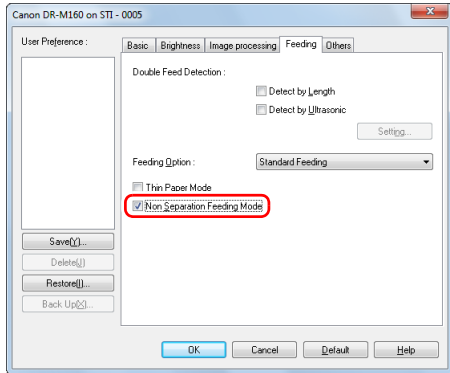

5 Click the [OK] button to close the settings screen.

Mac

1 Opens the scanner driver's Detail Settings screen. (See p. 47)

2 Set the [Paper Size] to half the size of the document (or [Detect automatically] when scanning nonstandard document).

3 Set [Scanning Side] to [Folio].

4 Click the [More] button.
The scanner driver's Detail Settings screen opens.

5 Select the [Non Separation Feeding Mode] check box.

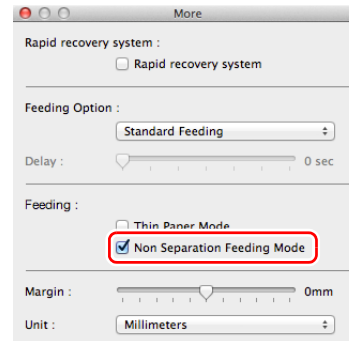

6 Click  to close the dialog box.

Setting the Long Document Mode

The length of documents that can be scanned with the scanner is normally 356 mm (14"), but you can scan documents up to 3,000 mm (118.1") long by setting the scanner to the Long Document mode.

! IMPORTANT

By selecting the Long Document mode and setting the [Paper Size] on the scanner driver settings screen to Auto-detection, documents of up to 3,000 mm (118.1") in length can be scanned. Note the following when using the Long Document mode:

- When scanning in the Long Document mode, if the document is placed on the scanner in a skewed position, it may hit the edges of the feeding area and be damaged. Be careful to place the document so that it is not skewed.
- When scanning with the Long Document mode, paper jam detection may react slowly, resulting in damage to the document. Be careful to avoid paper jams.
- When scanning long documents, make sure to set the scanner to non separation mode, and scan the documents one at a time.
- When scanning large-sized documents with the Long Document mode, scanning may be slower. Errors also occur due to memory shortage, and scanning may be disabled.

! IMPORTANT

Log on to Windows as an Administrator.

Windows

- 1 Click the Start button, and then click [All Programs], [Canon DR-M160], and [Canon imageFORMULA Utility]. imageFORMULA Utility starts.

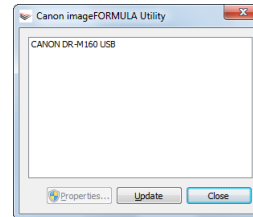

💡 Hint

In Windows 8.1/8, it is registered at the following location.

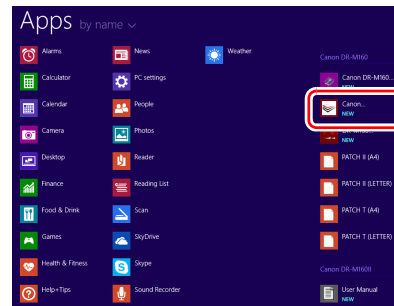

- Click [CANON DR-M160 USB] and click [Properties].
Scanner properties are displayed.

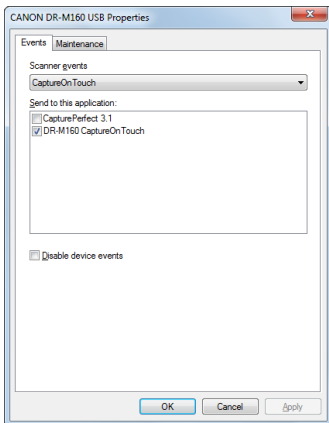

- Click the [Maintenance] tab, and then select a Long Document mode.
Select [Long Document Mode (1000 mm)] or [Long Document Mode (3000 mm)] depending on the length of the document.

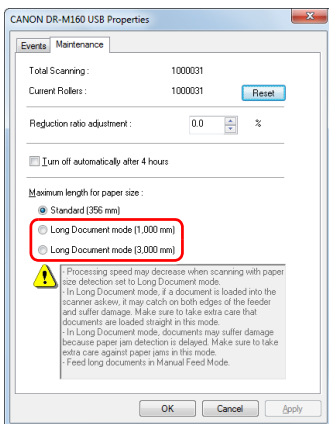

- Click [OK].

Mac

- Opens the scanner driver's Detail Settings screen. (See p. 47)
- Click  to display the [Scanner Information] dialog box. The [Scanner Information] dialog box appears.

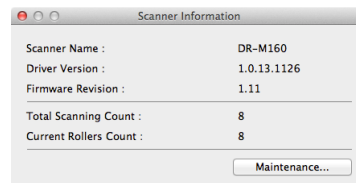

- Click [Maintenance].
The [Maintenance] dialog box appears.

- Select [Long Document mode (1,000 mm)] or [Long Document mode (3,000 mm)] depending on the length of the document.

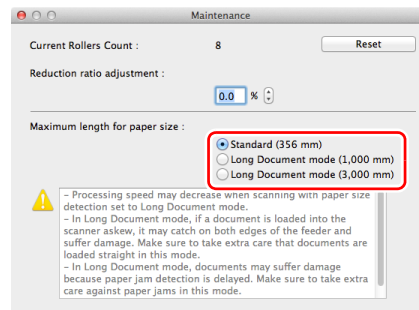

- Click  to close the dialog box.

Detecting a document double feed

This scanner includes a function to detect document double feeds. By using this function, the scanner will automatically stop when it detects that multiple documents have been fed at the same time. You can also specify whether to save the scanned image after scanning has finished and continue scanning the document (double feed detection ignore function).

To use the double feed detection function, you must first open the scanner driver settings screen and enable double feed detection. It is also necessary to set [Rapid recovery system] to use the double feed detection ignore function.

Setting procedure

1 Sets the scanning conditions.

→ **Windows**

→ **Mac**

2 Place the document as described in the “**Scanning multiple documents**” procedure on p. 25.

Windows

1 Opens the scanner driver's Detail Settings screen. (See p. 57)

2 Click the [Feeding] tab.

3 Select either the [Detect by Length] or the [Detect by Ultrasonic] check box (or both).

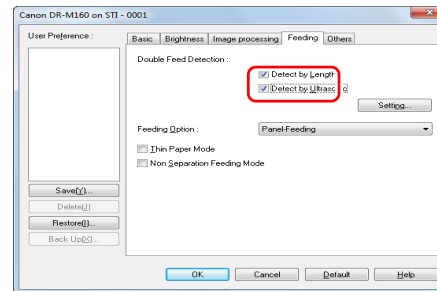

4 To use the double feed detection ignore function, open the [Others] tab and select the [Rapid recovery system] check box.

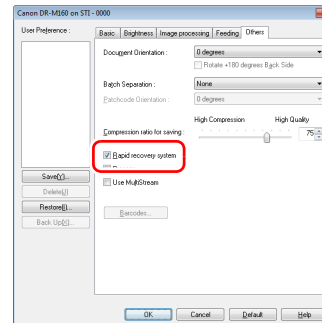

5 Click the [OK] button and close the settings screen.

Mac

- 1 Opens the scanner driver's Detail Settings screen. (See p. 47)
- 2 Select the [Double Feed Detection] check box, and then select any one of [Detect by Ultrasonic], [Detect by Length], and [Detect by Ultrasonic and Length].
- 3 Click the [More] button when the Double Feed Detection Ignore function is also used.
The scanner driver's Detail Settings screen opens.
- 4 Select the [Rapid recovery system] check box.



- 5 Click  to close the dialog box.

What to do when a double feed is detected

When not using the double feed detection ignore function

If a document double feed is detected during scanning, document feeding stops when the double fed documents are ejected. When this happens, the following error code is displayed in the Job No. Indicator of the operating panel.

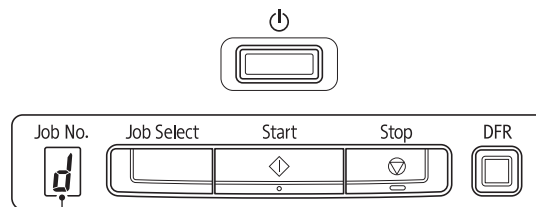

Double feed detection error code

Also, a message screen is displayed to notify you that a double feed has been detected.

Windows

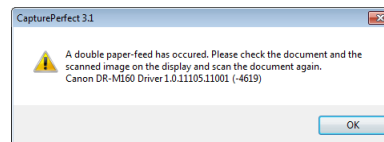

Mac

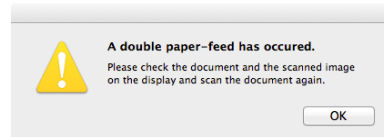

When this happens, stop the scanning in the application and then scan the documents again.

When using the double feed detection ignore function

If a document double feed is detected during scanning, document feeding stops when the double fed documents are ejected. The following error code is displayed in the Job No. Indicator of the operating panel, and the DFR button lights.

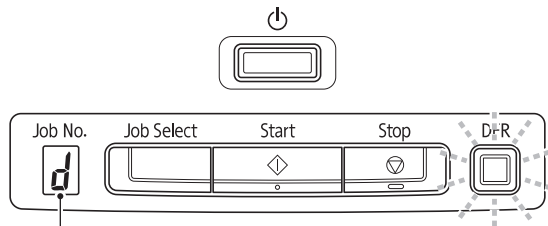

Double feed detection error code

Also, the [Rapid Recovery System] screen appears to enable you to specify whether to continue scanning.

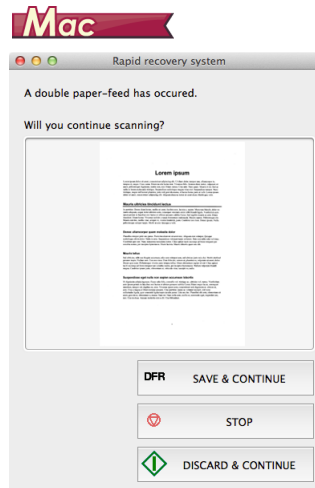

Windows

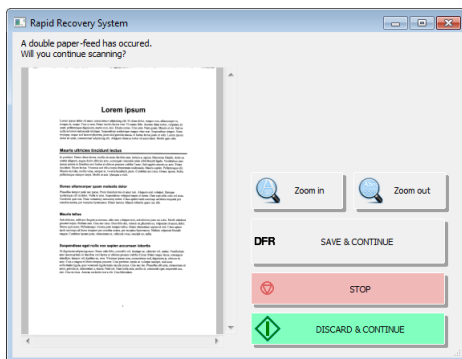

Buttons of [Rapid Recovery System] Screen	Buttons of Operating Panel	Description
[SAVE & CONTINUE]	DFR button	Saves the preview image as a scanned image and scans the rest of the document.
[STOP]	Stop button	Discards the preview image and stops scanning.
[DISCARD & CONTINUE]	Start button	Discards the preview image and continues scanning. Place the double fed document again before clicking this button.

Double Feed Retry

When a double feed has occurred, this function returns the document to the document feeder and re-feeds the pages (double feed retry). It is necessary to first open the scanner driver settings screen, and then enable the ultrasonic double feed detection and the double feed retry functions.

Setting procedure

Windows

- 1 Opens the scanner driver's Detail Settings screen. (See p. 57)
- 2 Click the [Feeding] tab.
- 3 Select the [Detect by Ultrasonic] check box.

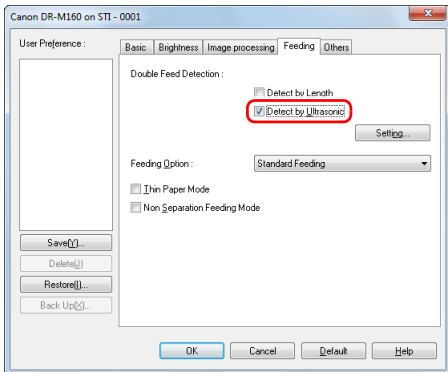

- 4 Click the [Settings] button.

- 5 Select the [Separation Retry] check box.

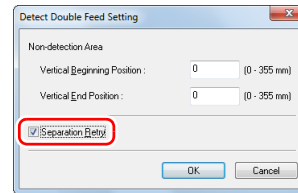

- 6 Click the [OK] button to return to the scanner driver settings screen.
- 7 Click the [OK] button to close the settings screen. From now on, a document will be automatically returned to the document feeder and re-fed when a double feed is detected during scanning.

Mac

- 1 Opens the scanner driver's Detail Settings screen. (See p. 47)
- 2 Select the [Double Feed Detection] check box and then select [Setting]. The Detail Settings screen opens.
- 3 Select the [Separation Retry] check box.

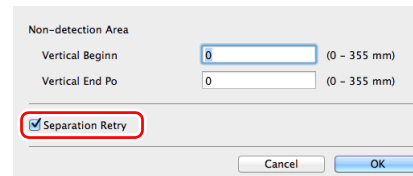

- 4 Click  to close the dialog box.

Scanning with CaptureOnTouch

What is CaptureOnTouch?

CaptureOnTouch is a scanning application that allows you to scan a document with a simple operation by following the instructions on the screen.

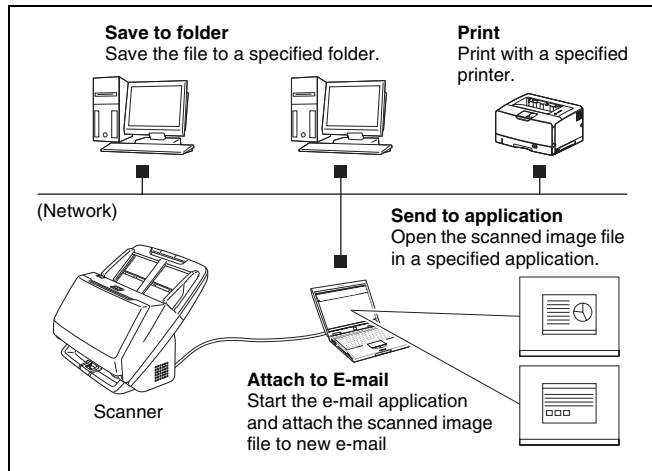

CaptureOnTouch is provided with multiple scanning methods that can be selected according to the purpose and application.

Scan First

Scan a document and then select the output method. This method allows you to easily scan a document by just following the instructions on the screen.

Select Scan Job

Register scanning settings from the scanning conditions to the output method as jobs, and then scan a document by just selecting the job that suits your purpose. This method is convenient when you want to repeat scanning using a set procedure.

Operating the scanner with the operating panel buttons

You can start scanning by selecting a job from the scanner's operating panel.

Format for saving image files

Excluding times when [Print] is selected as the output method, you can specify any of the following file formats for scanned images.

Windows

- PDF format
- TIFF format
- JPEG format
- BMP format
- PPTX format (file format for Microsoft PowerPoint 2007 and later)

Mac

- PDF format
- TIFF format
- JPEG format

Starting and Exiting CaptureOnTouch

By default, CaptureOnTouch becomes resident in the system when you start your computer.

Windows



Double-click  (CaptureOnTouch icon) in the taskbar to start CaptureOnTouch and display the main window.

Hint

- You can also start CaptureOnTouch from the Start menu. Click [Start] – [All Programs] – [Canon DR-M160] – [DR-M160 CaptureOnTouch].
- When [Make CaptureOnTouch resident] is turned on by using the [Basic settings] tab on the [Environmental settings], this shortens the time from pressing the scanner start button to the start of scanning. For details, see [“Environmental Settings” on p. 51](#).

Mac



Click  (CaptureOnTouch icon) in the menu bar and then click [Launch CaptureOnTouch] from the menu which appears to start CaptureOnTouch and display the main window.

Hint

- When [Make CaptureOnTouch resident] is turned on by using the [Basic settings] tab on the [Environmental settings], this shortens the time from pressing the scanner start button to the start of scanning. For details, see [“Environmental Settings” on p. 53](#).

Exiting CaptureOnTouch

Windows

Click  at the top of the window to close the CaptureOnTouch main window. When doing so, the main window closes but CaptureOnTouch is kept as resident in the system.

To stop CaptureOnTouch being resident in the system, click the  (CaptureOnTouch icon) in the taskbar, and select [Exit] from the menu.

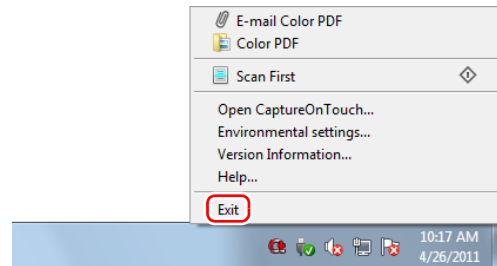

CaptureOnTouch becomes no longer resident in the system and the icon disappears from the taskbar.

Mac

To close the CaptureOnTouch window, click  at the top of the window. This closes the window, but CaptureOnTouch will continue to reside in the system.

click  (CaptureOnTouch icon) in the menu bar, and select [Exit] from the menu.

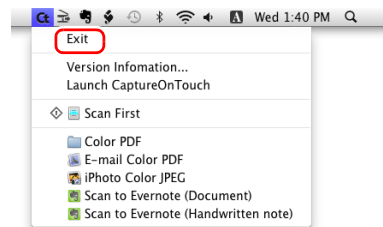

Restarting CaptureOnTouch

To use CaptureOnTouch after it is no longer resident in the system, restart it by following the procedure below. CaptureOnTouch will start and become resident in the system again.

Windows

- Click [Start] – [All Programs] – [Canon DR-M160] – [DR-M160 CaptureOnTouch].

Hint

In Windows 8.1/8, it is registered at the following location.

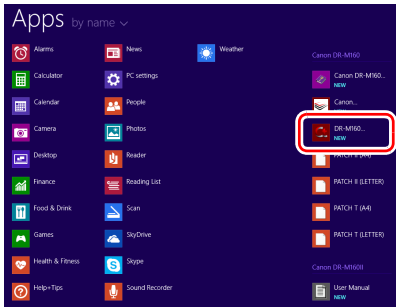

Mac

- Open [GO] - [Applications] folder from the Finder, and double-click [CaptureOnTouch DR-M160].

Scan First

Scan a document and then select the output method. This method allows you to easily scan a document by just following the instructions on the screen.

Operation Flow

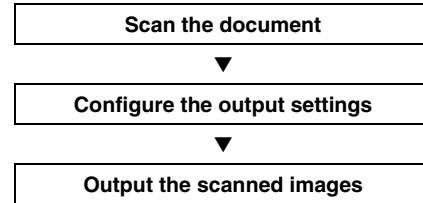

1 Place the document in the scanner.

2 Click [Scan First].



The top screen of Scan First appears.

3 Set the scan method in the top screen.

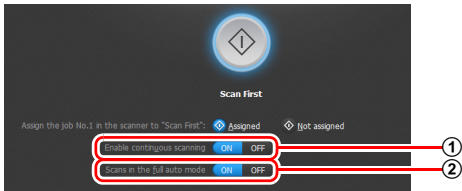

- 1 Specify whether to enable continuous scanning. When scanning multiple documents as one scanned image or splitting up a large document to scan in parts, select [ON] to enable continuous scanning.
- 2 Specify whether to scan the document in full auto mode. When you want to specify arbitrary scanning conditions, select [OFF] and configure the scanner settings. (See p. 45)

4 Click the Start button.



The document is scanned. While scanning is in progress, the number of pages scanned is displayed in addition to the scanner settings.
When scanning is finished, the Output settings screen appears.

! IMPORTANT

If you configure scanning conditions that consume a large amount of the computer's memory, scanning may stop because of insufficient memory. If an error message appears due to insufficient memory while scanning is in progress, exit the application, change the scanning conditions, and then try scanning again.

💡 Hint

If a document is scanned when [Enable continuous scanning] is set to [ON], the Continuous Scanning screen (see p. 48) appears when the scanning of the document is finished.

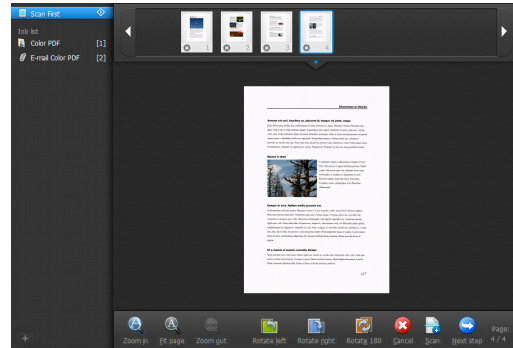

If you place the next document and click [Scan], scanning of the document starts.
When scanning of all the documents is finished, click [Next step].

5 Configure the settings related to output and then output the scanned images.



- ① Configure the settings related to output. (See p. 49)
- ② Click this button to output the scanned images. The button name differs for each output method. For example, it is [Save] when the output method is set to [Save to folder].

When output is finished, the complete screen appears. Scan First is now finished.

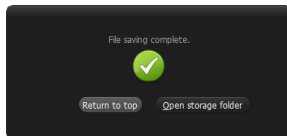

Hint

- Clicking [Return to top] returns to the main screen of Scan First.
- When output methods apart from [Attach to E-mail] or [Print] are specified, you can click [Open storage folder] to open the folder in which the scanned images were saved.

Select Scan Job

Register scanning settings from the scanning conditions to the output method as jobs, and then scan a document by just selecting the job that suits your purpose. This method is convenient when you want to repeat scanning using a set procedure.

Operation Flow

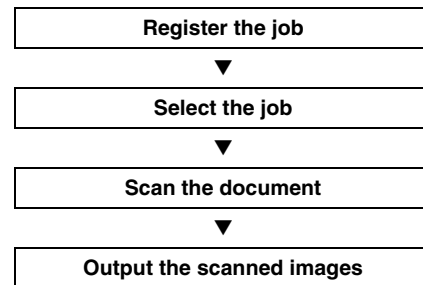

Registering and Editing Jobs

In CaptureOnTouch, up to 9 jobs can be registered for use with Select Scan Job.

1 Click the button.

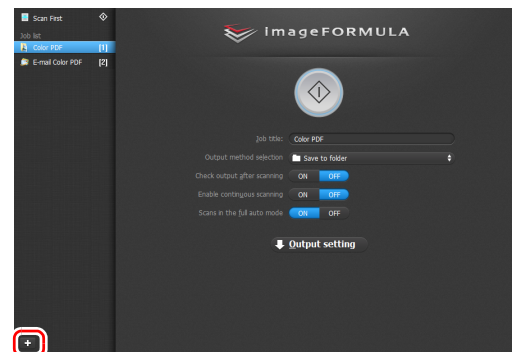

2 Enter the job name, and press the Enter key.

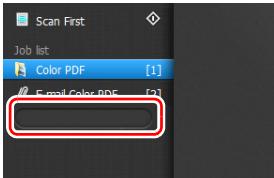

Hint

Job numbers up to 9 are added (in numerical order) to the end of the set job name. By specifying the job number with the operating panel, you can start scanning after pressing the operating panel button. (See p. 45)

3 Specify the output method of the job. (See p. 49)



4 Click [Output settings], and configure the output settings.

The output setting items differ depending on the specified output method. For details on the setting items, see the Help of CaptureOnTouch.



Selecting a Job and Scanning

1 Place the document in the scanner. (See p. 25)

The top screen of Select Scan Job appears.

2 Click a job.





Hint

- If you set [Enable continuous scanning] to [ON], you can continue to scan additional documents after all the pages of the initial document are scanned.
- If you set [Check output after scanning] to [ON], you can check the output settings after scanning.

3 Click the Start button.

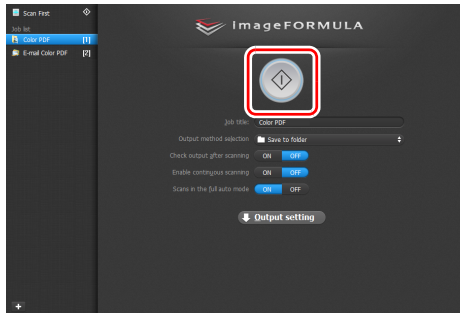

The document is scanned. While scanning is in progress, the number of pages scanned is displayed in addition to the scanner settings.

When all the pages of the document are scanned, the scanned images are output according to the registered job settings and the complete screen appears.

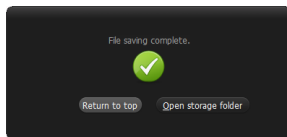

! IMPORTANT

If you configure scanning conditions that consume a large amount of the computer's memory, scanning may stop because of insufficient memory. If an error message appears due to insufficient memory while scanning is in progress, exit the application, change the scanning conditions, and then try scanning again.



Hint

- Clicking [Return to top] returns to the top screen of Select Scan Job.
- When output methods apart from [Attach to E-mail] or [Print] are specified, you can click [Open storage folder] to open the folder in which the scanned images were saved.

When [Enable continuous scanning] is set to [ON]

The Continuous Scanning screen (see p. 48) appears when all the pages of the document are scanned.

If you want to scan another document, place the document in the scanner and then click [Scan].

When scanning of all the documents is finished, click [Next step].

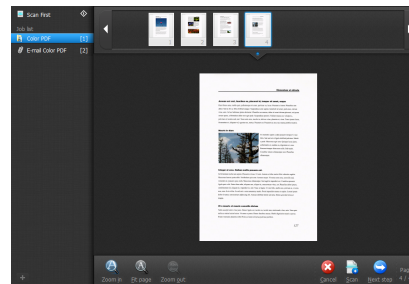

When [Check output after scanning] is set to [ON]

The Output Confirmation screen appears before the scanned images are output.

Change the settings for the output method if necessary and then click the output button. The name of the output button differs for each selected output method.

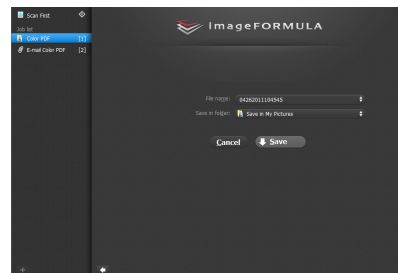

Operating the scanner with the operating panel buttons

You can start scanning by selecting a job from the scanner's operating panel.

- 1 Set a job number every time a job is registered with CaptureOnTouch.**
- 2 Place the document in the scanner.**
- 3 Press the Job Select button in the operating panel to display the required job number in the Job No. Indicator.**
The job numbers of jobs displayed in the operating panel are allocated as follows.

Job No.	Job
1	Scan First (default / modifiable)
2 to 9	Jobs registered with CaptureOnTouch.

- 4 Press the Start button in the operating panel.**
CaptureOnTouch is launched and the scanning of the selected job starts.



Hint

When scanning jobs selected with the operating panel buttons, the CaptureOnTouch main window automatically closes 5 seconds after the output process finishes.

Scanner Settings

By default, CaptureOnTouch scans with scanning conditions that match the document because scanning in full auto mode is enabled. If you want to specify, for example, the scanning mode and document size, you can configure the desired scanning conditions in the scanner settings.

The scanner setting items are common to Scan First and Select Scan Job.

When Scan First:

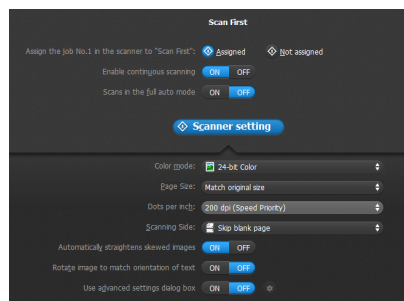

For Scan First, configure the scanner settings before you start scanning.

When Select Scan Job:

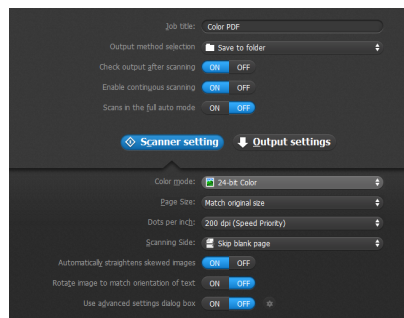

For Select Scan Job, configure the scanner settings for each job.

Setting Basic Items

Scanner settings include the basic items that are configured in [Scanner Setting], and the setting items that are configured in the advanced settings dialog box. The settings in the advanced settings dialog box are applied for settings other than the basic items. The settings in the driver settings dialog box are applied for any other settings.

Color mode

Select from the following modes for scanning documents.

Detect automatically	Automatically determines the color mode based on the document content and scans.
24-bit Color	Scans the document in color.
Grayscale	Scans the document in Grayscale.
Black and White	Scans the document in black and white (binary).

Page Size

Specify the page size of the document.

If you specify [Match original size], the page size of the scanned document is detected and the images are saved at the detected size.

Dots per inch

Specify the scanning resolution.

When [Detect automatically] is specified, the resolution is detected automatically from the content of the scanned document.

Scanning Side

Specify whether to scan only one side or both sides of a document.

When [Skip blank page] is specified, any blank page detected within the document is skipped during scanning.

Automatically straightens skewed

When a document is scanned skewed, the skewed scanned images are detected and then straightened.

Rotate image to match orientation of text

The orientation of text in scanned images is detected, and the images are rotated so that the text is correctly oriented.

Use advanced settings dialog box

Configure scanner settings other than the basic items in the advanced settings dialog box (scanner driver).

Hint

To open the scanner driver, click [OFF] for [Scan in Full Auto mode], and then click the [Scanner Setting] button. Click [ON] for [Use Advanced Settings dialog box] and then click .

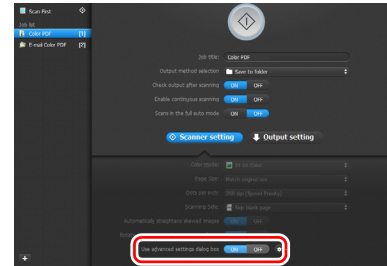

Windows

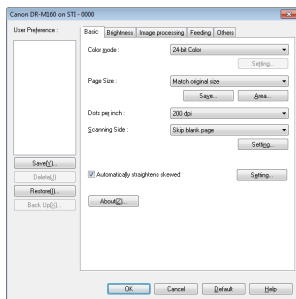

Mac

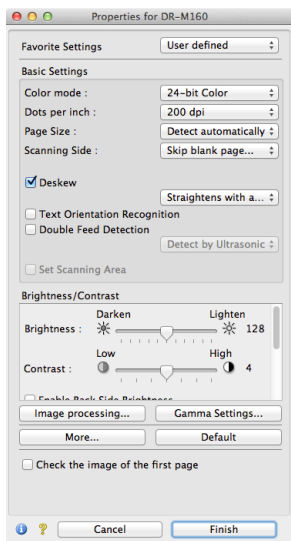

For details on the setting items, see the Help of the driver settings dialog box.

Hint

The driver settings dialog box includes setting items that are the same as the basic items in [Scanner Settings], but the setting for each of the them is stored separately. Which settings are used during scanning differs as follows depending on the setting of the [Use advanced settings dialog box] check box.

Setting of [Use advanced settings dialog box]	Basic items	Other than basic items
OFF	Settings of [Scanner Settings]	Settings of the advanced settings dialog box of the scanner driver
ON	Settings of the advanced settings dialog box of the scanner driver	

Operation in Continuous Scanning Screen

If a document is scanned with either Scan First or Select Scan Job when [Enable continuous scanning] is set to [ON] in the Start screen, the Continuous Scanning screen appears when all of the pages of the placed document have been fed. You can confirm the scanned images and then continue scanning.

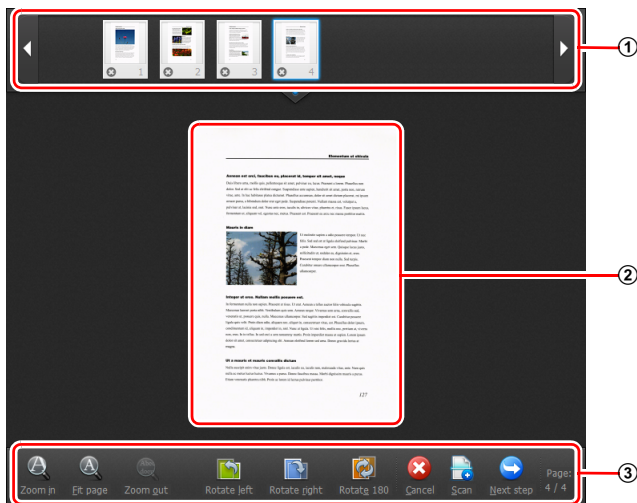

① Thumbnail Display Area

Displays the thumbnail images of the scanned document. The following operations are possible.

Click a thumbnail image to display a preview of that scanned image in the preview area.

Drag thumbnail images to change the positions of pages (Scan First only).











Click  on a thumbnail image to delete the scanned image for that page (Scan First only).

② Preview Area

Displays the preview images of the scanned document.

③ Preview Controls

Control the preview images and cancel or continue scanning with the following buttons.

Tools (Name)	Description
 (Zoom in)	Enlarges the preview image.
 (Fit page)	Enlarges or reduces the preview image to fit the current window size.
 (Zoom out)	Reduces the preview image.
 (Rotate left)	Rotates the image 90 degrees counterclockwise. (Scan First only)
 (Rotate right)	Rotates the image 90 degrees clockwise. (Scan First only)
 (Rotate 180)	Rotates the image 180 degrees. (Scan First only)
 (Cancel)	Cancels the image scanning operation and returns to the top screen.
 (Scan)	Starts scanning of the next document.
 (Next step)	Proceeds to the next step in the scan process.
 (Page Number / Total Number of Pages)	Displays the current page and total number of pages.

Setting the Output Method

CaptureOnTouch is provided with various output methods for processing scanned images.

The output method specification is common to Scan First and Select Scan Job.

Scan First:

For Scan First, select an output method in the output method selection screen which appears after scanning, and then specify each of the output method items.

Select Scan Job:

For Select Scan Job, specify the output method separately for each job.

The setting items related to output differ depending on the output method.

Save to folder

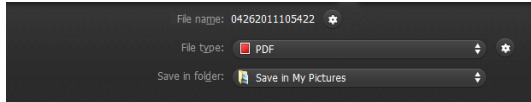

Saves the scanned images to a specified folder. When you specify this output method, configure the settings for the image files to be saved.

Attach to E-mail

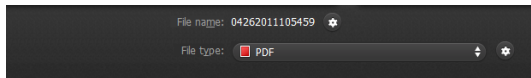

Attaches the scanned images to new e-mail in the e-mail application. When you specify this output method, configure the settings for the image files to be attached to e-mail.

To use this feature, an e-mail application such as Windows Mail or Outlook Express (both of these applications come standard with the operating system) that supports MAPI (Microsoft Messaging Application Programming Interface) needs to be specified as the default program of the operating system.

Standard compatible software is given below.

Windows

- Email applications such as Windows Mail or Outlook Express (both of which are standard applications provided with the operating system) that support MAPI (Messaging Application Programming Interface).

Mac

- Mail (application that comes standard with the operating system)

Print

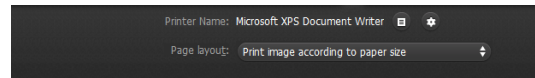

Prints the scanned images with a specified printer. When you specify this output method, specify the printer for printing.

Send to application

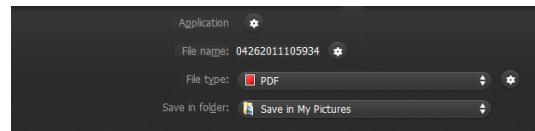

Saves the scanned image file in a specified folder and then opens it with a specified application. When you specify this output method, click  in [Application] and specify the executable file of an application that can open image files. In addition, configure the settings of the image file to be saved.

Other Output Methods

Windows

In an environment in which Microsoft SharePoint Server has been introduced, you can send scanned images to a Microsoft SharePoint site. To do so, select [Save in Microsoft SharePoint] as the output method, and configure the setting for the image files to be sent. You must also open the advanced settings dialog box and configure settings such as the URL of the Microsoft SharePoint site, account information, and the save destination folder. For details on settings, see the help (click the [Help] button in the settings screen).

! IMPORTANT

The Microsoft SharePoint plug-in supports only the Windows authentication format. Scanned images cannot be sent to Microsoft SharePoint sites that use other authentication formats.

About file formats

Select the file format. If you select a file format other than BMP, you can click  to configure advanced settings.

PDF

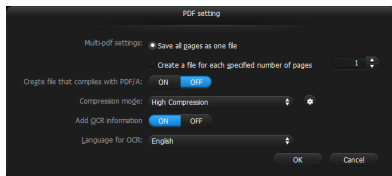

In [Multi-pdf settings], specify whether to save the scanned images as a multi page file ([Save all pages as one file]) or single page files ([Create a file for each specified number of pages]).

Windows For [Create file that complies with PDF/A], select [ON]. For [Compression mode] select either [Standard] or [high compression].

Click , and in the dialog box that appears specify the compression rate that you want.

TIFF

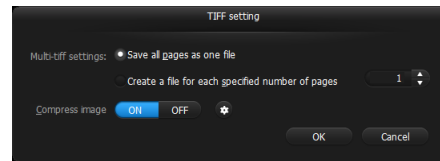

In [Multi-tiff settings], specify whether to save the scanned images as a multi page file ([Save all pages as one file]) or single page files ([Create a file for each specified number of pages]).

Windows After you select ON for [Compress image], click , and in the dialog box that appears specify the compression rate that you want.

JPEG

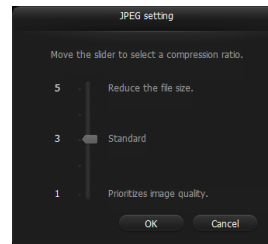

You can specify the compression rate of JPEG images.

Windows

PPTX

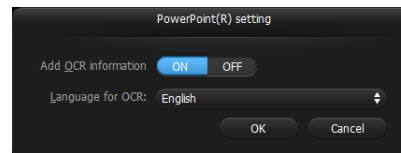

You can specify whether to add OCR information to the scanned images.

Environmental Settings

To configure the environmental settings of CaptureOnTouch, open the [Environmental settings] dialog box.

Windows

Click  (CaptureOnTouch icon) in the taskbar, and select [Environmental settings] from the menu.

The following describes the setting items of each tab displayed in the [Environmental settings] dialog box.

[Basic settings] Tab

On the [Basic settings] tab, configure the following settings.

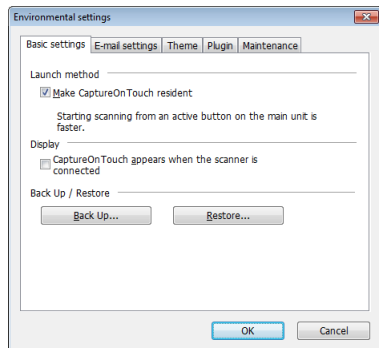

Launch method setting

By default, CaptureOnTouch becomes resident in the system when you start your computer. Clear the [Make CaptureOnTouch resident] check box to not make CaptureOnTouch resident in the system.

Display setting for when scanner connected

Select the [CaptureOnTouch appears when the scanner is connected] checkbox to open the main screen of CaptureOnTouch automatically when the scanner is connected to the computer. This setting is only enabled when CaptureOnTouch is running (or resident in the system).

Back Up / Restore

Use the [Back Up] and [Restore] buttons to back up the configuration file (settings, registered jobs, etc.) of CaptureOnTouch and restore the settings from the backup data.

! IMPORTANT

Please note that when a job with the output method set to [Save in Microsoft SharePoint] is registered, the setting items related to Microsoft SharePoint will not be backed up.

[Back Up] button

Back up the settings of CaptureOnTouch to a backup file (*.cot). You can store the initial settings of CaptureOnTouch by performing a backup before you first use CaptureOnTouch.

[Restore] button

Restore the settings from the backup registry file. When using multiple computers, you can back up the environmental settings of one computer and restore these settings on the other computers so that all of the computers have the same settings.

[E-mail settings] Tab

On the [E-mail settings] tab, set the maximum size for the image files to be attached to e-mail.

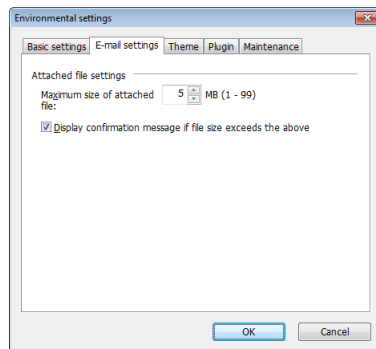

Maximum size of attached file

Select the [Display confirmation message if file size exceeds the above] check box to display a confirmation message when an attached file exceeds the maximum size.

- For Scan First, a confirmation message appears if the file size of scanned images is larger than the file size set here.
- For Select Scan Job, a confirmation message appears if the set file size is exceeded during scanning.

[Theme] Tab

On the [Theme] tab, specify the appearance of the main screen of CaptureOnTouch.

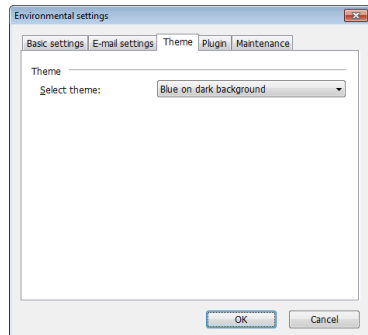

Select theme

Specify the appearance type for the main screen of CaptureOnTouch with [Select theme].

[Plugin] Tab

On the [Plugin] tab, confirm the plugins that have been added to CaptureOnTouch.

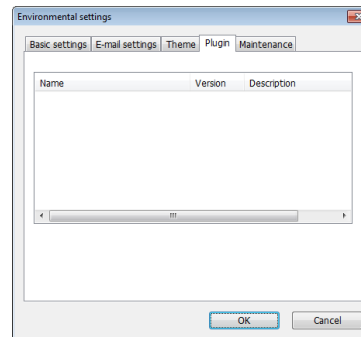

Hint

Initially, the list under the [Plugin] tab is empty.

[Maintenance] tab

With the [Maintenance] tab, you can output log files for CaptureOnTouch maintenance purposes.

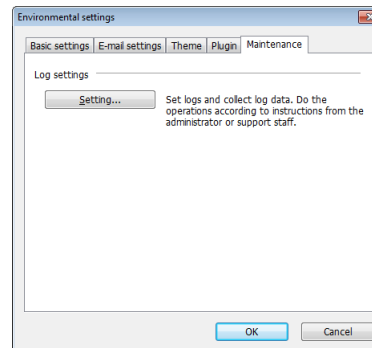

Mac

Click [Preferences] from the [CaptureOnTouch DR-M160] menu while the main screen of CaptureOnTouch is displayed.

The following describes the setting items of each tab displayed in the [Environmental Settings] dialog box.

[Basic settings] Tab

On the [Basic settings] tab, configure the following settings.

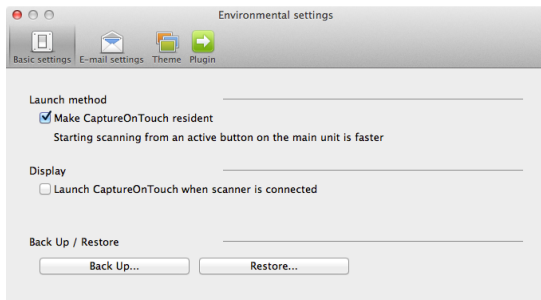

Launch method setting

By default, CaptureOnTouch becomes resident in the system when you start your computer. Clear the [Make CaptureOnTouch resident] check box to not make CaptureOnTouch resident in the system.

Display setting for when scanner connected

Select the [Launch CaptureOnTouch when scanner is connected] checkbox to open the main screen of CaptureOnTouch automatically when the scanner is connected to the computer. This setting is only enabled when CaptureOnTouch is running (or resident in the system).

Back Up / Restore

Use the [Back Up] and [Restore] buttons to back up the configuration file (settings, registered jobs, etc.) of CaptureOnTouch and restore the settings from the backup data.

[Back Up] button

Back up the settings of CaptureOnTouch to a backup file (*.plist). You can store the initial settings of CaptureOnTouch by performing a backup before you first use CaptureOnTouch.

[Restore] button

Restore the settings from the backup file.

When using multiple computers, you can back up the environmental settings of one computer and then perform a restore on the other computers so that all of the computers have the same settings.

[E-mail settings] Tab

On the [E-mail settings] tab, set the maximum size for the image files to be attached to e-mail.

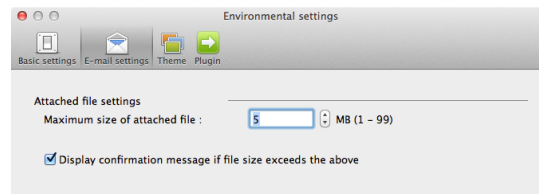

Maximum size of attached file

Select the [Display confirmation message if file size exceeds the above] check box to display a confirmation message when an attached file exceeds the maximum size.

- For Scan First, a confirmation message appears if the file size of scanned images is larger than the file size set here.
- For Select Scan Job, a confirmation message appears if the set file size is exceeded during scanning.

[Theme] Tab

On the [Theme] tab, specify the appearance of the main screen of CaptureOnTouch.

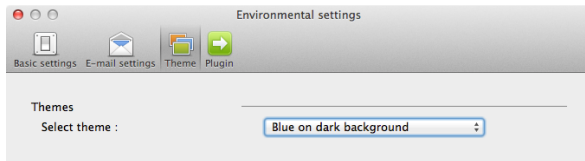

Select theme

Specify the appearance type for the main screen of CaptureOnTouch with [Select theme].

[Plugin] Tab

On the [Plugin] tab, confirm the plugins that have been added to CaptureOnTouch.

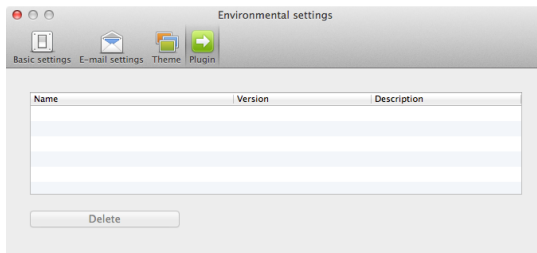

Hint

Initially, the list under the [Plugin] tab is empty.

Deleting plugins

Click the [Delete] button to delete a plugin selected in the list.

Scanning with CapturePerfect

Scanning with CapturePerfect

This section describes procedures from launching CapturePerfect to selecting a scanner, as well as procedures for scanning with the [Scan batch to file] function.

See the “CapturePerfect Operating Guide” or help for details.

1 From the Windows task bar, click [Start] and then select [All Programs].

Then click [CapturePerfect 3.1] followed by [CapturePerfect 3.1].

2 Click [Select Scanner] in the [Scan] menu.

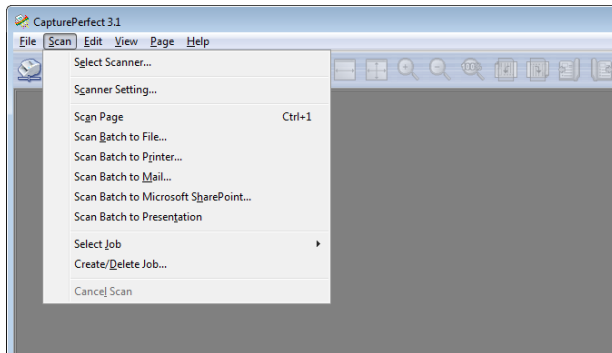

3 Select [Canon DR-M160] and click [OK].

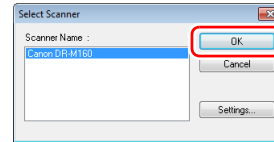

Hint

If [Canon DR-M160] does not appear, reinstall the scanner driver. (See p. 7)

4 Set the default paper size and click [OK].

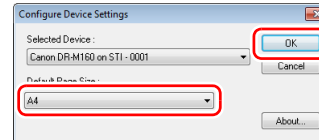

Hint

- The [Configure Device Settings] dialog box appears when selecting [Canon DR-M160] and clicking [OK] for the first time in the [Select Scanner] dialog box, and when [Settings] is clicked in the [Select Scanner] dialog box.
- These settings will apply when [Default] is clicked in the ISIS driver dialog box.
- For the TWAIN driver, the default size will be set to A4 and this cannot be modified.

5 Click [Scanner Setting] in the [Scan] menu.

6 Configure the scanning conditions. (See p. 57)

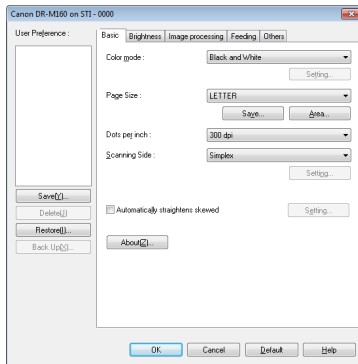

7 Place the document. (See p. 25)

8 Click [Scan Batch to File] in the [Scan] menu.

9 Configure the save destination, the name of the file to be saved and the file format, and then click [Save] to start scanning.

IMPORTANT

If you configure scanning conditions that consume a large amount of the computer's memory, scanning may stop because of insufficient memory. If an error message appears due to insufficient memory while scanning is in progress, exit the application and try scanning again using different scanning condition settings.

10 If the placed document is removed, the scan will be interrupted and the [Continue Scanning] dialog box appears. To continue scanning, add a document and click [Continue Scanning] To stop scanning, click [Stop Scanning].

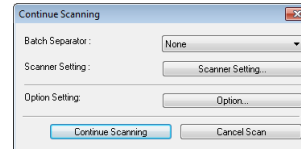

11 When scanning is finished, click [Exit] in the [File] menu.

Setting the Scanner Driver

When you scan a document in an ISIS compatible (CapturePerfect, etc.) or TWAIN compatible application, open the scanner driver and configure the scanning conditions and other settings. This section describes the configuration and functions of the scanner driver.

Configuration and Functions of the Scanner Driver

→ **Windows**

→ **Mac**

Windows

The scanner driver consists of the following tabs.

Hint

For details on the setting screen, see the Help of the scanner driver. Click the [Help] button of the driver to display help related to the corresponding tab or dialog box.

[Basic] tab

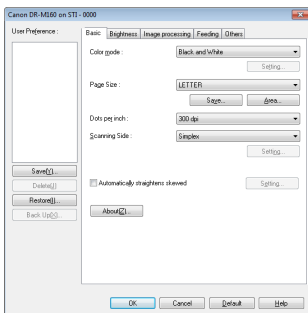

Adjust the brightness and contrast of scanned images.

Configure basic scanning conditions such as the mode, page size, resolution, and scanning side. In addition, you can click the [Area] button and specify the area to be scanned.

Hint

Depending on the ISIS compatible application, the application may have its own screen for setting scanning conditions. If the scanner driver is opened in such an application, setting items related to the functions provided by the scanner driver other than scanning conditions will be displayed on the [Basic] tab.

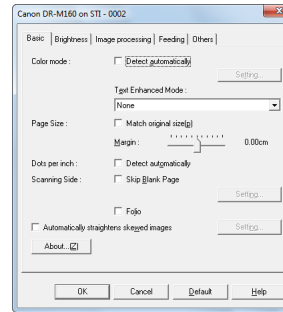

[Brightness] tab

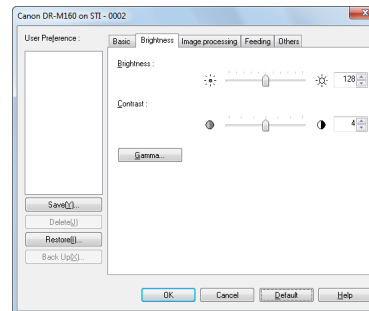

In addition, you can also click [Gamma] and set the gamma correction value for scanned images.

[Image processing] tab

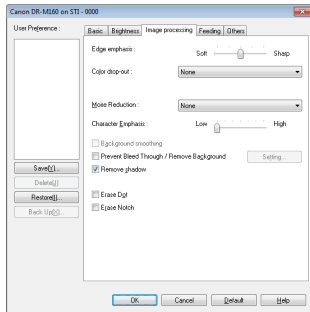

Set the processing method for scanned images.

[Feeding] tab

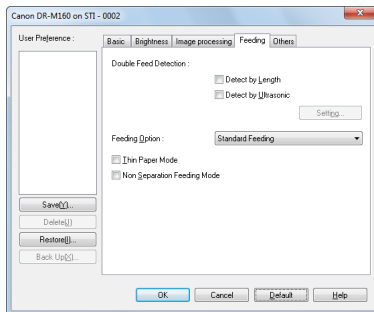

Specify scanner operations related to document feeding.

[Others] tab

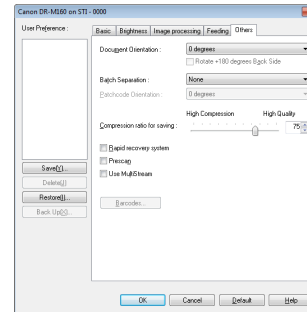

Configure special scan method and image processing settings.



When the scanner driver is opened from CaptureOnTouch, the following settings screen of the scanner driver appears.

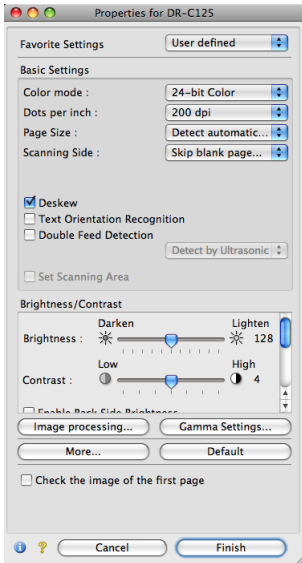

Hint

When the Advanced Settings screen is called from some applications, the Advanced Settings screen may have the Simple mode and Advanced mode.

Simple Mode

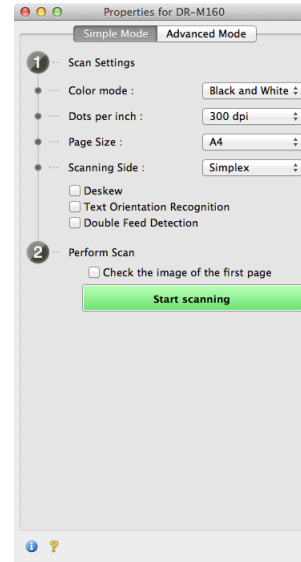

Advanced Mode

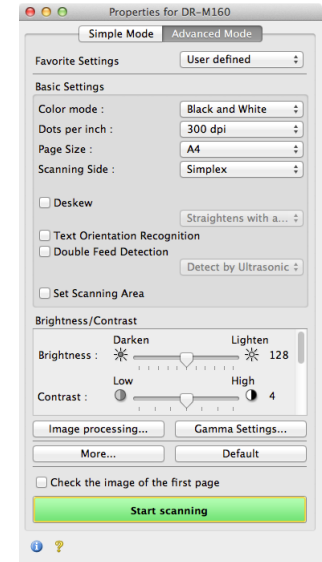

Setting Basic Scanning Conditions

This section provides an overview of the basic setting items that are the minimum requirements when configuring the scanner settings.

→ **Windows**

→ **Mac**

Windows

Confirming Basic Conditions for Scanning

When you scan a document, make sure you confirm the [Color mode], [Page Size], [Dots per inch], and [Scanning Side] basic conditions in the Basic settings dialog box.

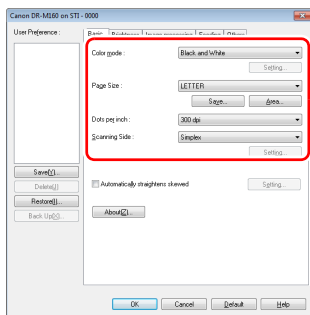

Color mode

Select the scanning mode.

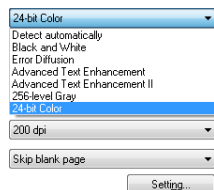

- [Advanced Text Enhancement] and [Advanced Text Enhancement II] remove or process the background color and background surrounding text to enhance the text for easy reading. When [Advanced Text Enhancement II] is selected, you can make the text in scanned images easier to read by adjusting the contrast on the [Brightness] tab.
- [Detect automatically] detects whether the document is in color, grayscale, or black and white. You can configure advanced settings related to the detection method by clicking [Setting]. For details, see the Help.

Page Size

Select the page size that matches the document to be scanned.

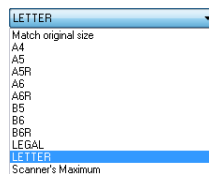

If [Match original size] is selected, the edges of the document are detected and images that match the size of the document are saved.

Dots per inch

Select the scanning resolution.

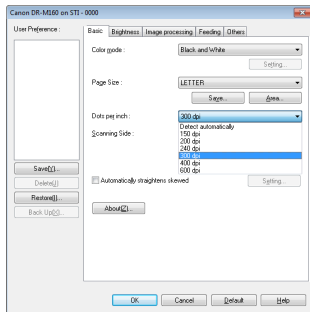

- Higher resolutions provide clearer images but result in larger file sizes and slower scanning.
- When [Detect automatically] is specified, the resolution is detected automatically from the content printed in the document.

Scanning Side

Select which of the sides of the document to scan.

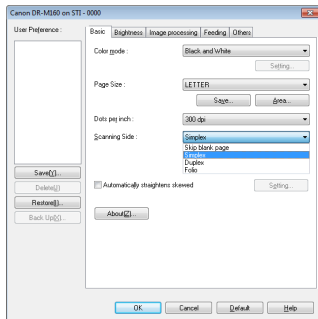

If the scanning side is set to [Skip blank page], the images of blank pages are deleted when images are saved.



Confirming Basic Conditions for Scanning

When you scan a document, make sure you confirm the [Color mode], [Dots per inch], [Page Size], and [Scanning Side] basic conditions in the settings screen of the scanner driver.

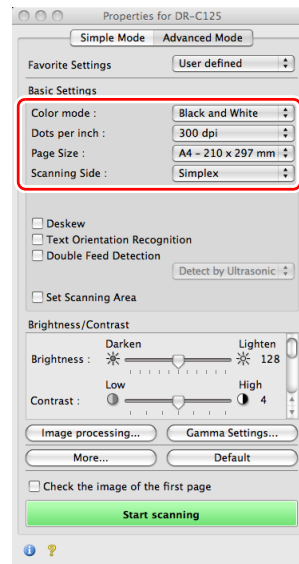

Color mode

Select the scanning mode.

Detect automatically...
 Black and White
Error Diffusion
Advanced Text Enhancement II
256-level Gray
24-bit Color

- [Advanced Text Enhancement II] removes or processes the background color and background surrounding text to enhance the text for easy reading.
- [Detect automatically] detects whether a document is color, grayscale, or black and white based on its content. When this is selected, you can configure detailed settings for the detection method. Refer to the Help for details.

Dots per inch

Select the scanning resolution.

Detect automatically
150 dpi
200 dpi
240 dpi
 300 dpi
400 dpi
600 dpi

- Higher resolutions provide clearer images but result in larger file sizes and slower scanning.
- When [Detect automatically] is specified, the resolution is detected automatically from the content printed in the document.

Page Size

Select the page size that matches the document to be scanned.

Detect automatically
 A4
A5
A5R
A6
A6R
B5
B6
B6R
LEGAL
LETTER
Scanner's Maximum
Add/Delete...

If [Detect automatically] is selected, the edges of the document are detected and images that match the size of the document are saved.

Scanning Side

Select which of the sides of the document to scan.

Simplex
Duplex
Skip blank page...
Folio

If the scanning side is set to [Skip blank page], the images of blank pages are deleted when images are saved.

Scanning Documents of Unregistered Page Sizes

Windows

You can register a non-standard page size that has not been registered as a page size by naming and registering it as a custom page size in the Custom Paper Size dialog box, which is opened from the [Save] button on the [Basic] tab.

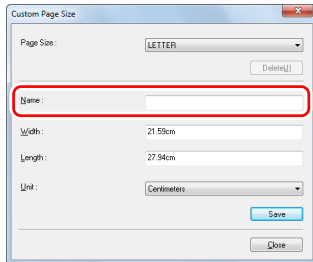

Mac

Configuring the following settings allows you to scan a document of an unregistered page size. When scanning a document of a non-standard page size, select [Add/Delete] for [Page Size] to display the [Add/Delete Page Size] dialog box. Name and register the unregistered page size in [Page Size].

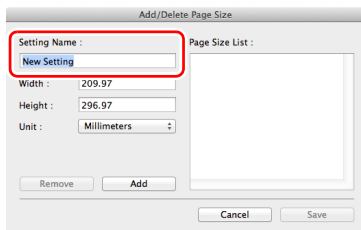

Specifying the Scan Area

Configure the following settings when you want to specify the area of the document to be scanned.

Specifying an area

Windows

Specify the area of the document to be scanned in the Scan Area dialog box, which is opened from the [Area] button on the [Basic] tab.

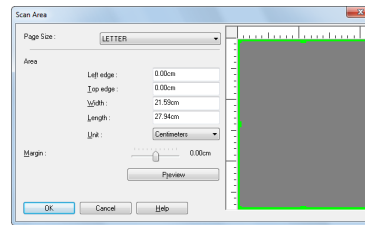

Mac

Select the [Set Scanning Area] check box and then specify the area of the document to be scanned.

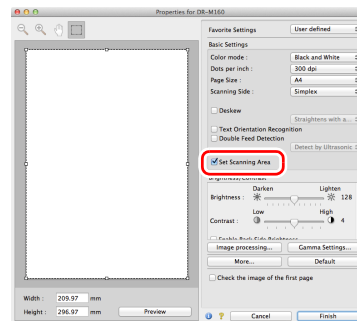

Also, if you scan the document when [Check the image of the first page] is selected, only one page of the document is scanned and the corresponding scanned image is displayed in the preview window.

Configuring Scanner Settings According to Purpose

Set the scanning conditions according to the scanning purpose.

When you want to delete the images of the blank pages in two-sided documents

Windows

Set the scanning side setting to [Skip Blank Page] on the [Basic] tab to delete the images of the blank pages in the document.

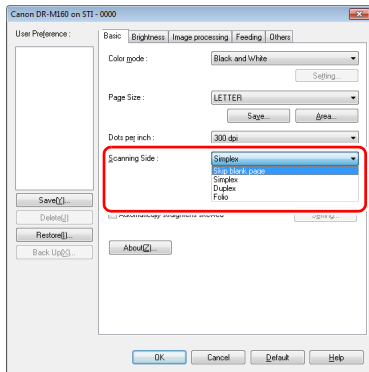

If [Skip Blank Page] is selected, the [Setting] button is enabled, and you can adjust the level for judging whether pages are blank.

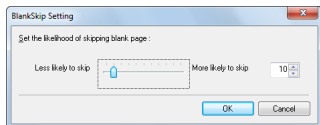

Mac

Set the scanning side setting to [Skip blank page] to delete the images of the blank pages in the document.

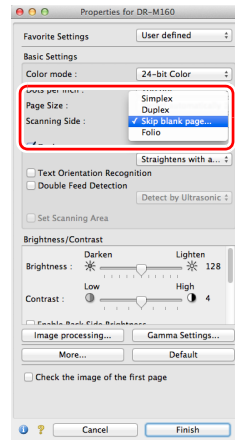

If [Skip blank page] is selected, you can adjust the level for judging whether pages are blank.

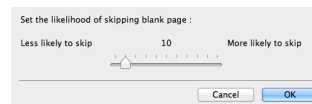

When you do not want to scan colored lines and text

Windows

Specify the color (red, green, blue, all colors) to be ignored (dropped out) in the color drop-out settings on the [Image processing] tab, and that color will be removed from the scanned image.

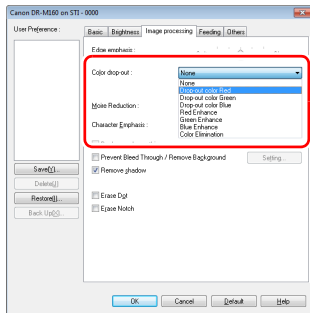

When you want to enhance a particular color

Windows

Specify the color (red, green, blue) to be enhanced in the color drop-out settings on the [Image processing] tab, and that color will be enhanced in the scanned image.

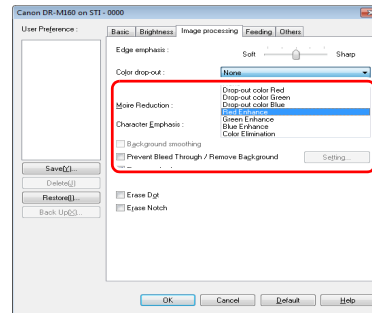

Mac

Click [Image processing], and when a dialog box opens, specify the color (red, blue, or green) to be ignored (dropped out) in [Color dropout], and that color will not be scanned.

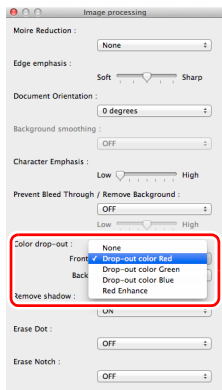

Mac

Click [Image processing] and specify the color (red, blue, or green) in [Color dropout] in the dialog box that appears to enhance that color in the document.

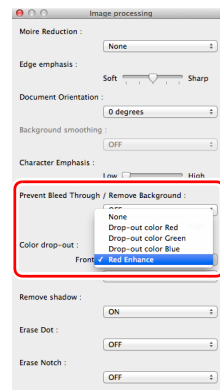

When you want to enhance contours in images



Adjust the edge emphasis setting on the [Image processing] tab.

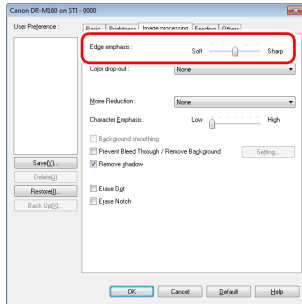

When you want to make lines and text in scanned images thicker or thinner



Drag the [Character Emphasis] slider in the [Image processing] tab to make lines and text in the scanned images thicker or thinner.

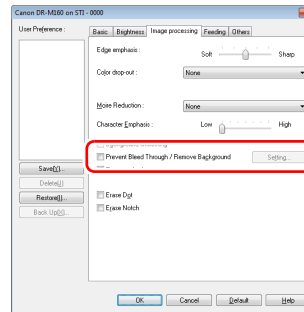

Click [Image processing] and adjust the edge emphasis settings in the dialog box which appears.

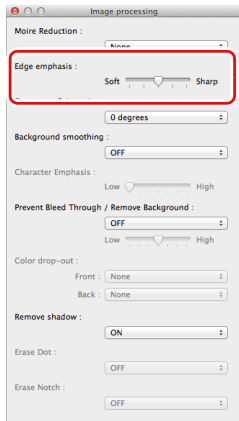

Click [Image processing], and in the dialog box that appears adjust letter and line thickness settings.

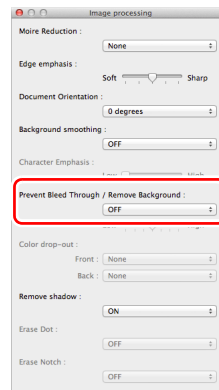

When you want to enhance text that is difficult to read because of factors such as the background of the scanned document

Windows

Select [Advanced Text Enhancement] or [Advanced Text Enhancement II] in the mode setting on the [Basic] tab. The background behind the text is removed or processed so that the text is emphasized for better readability.

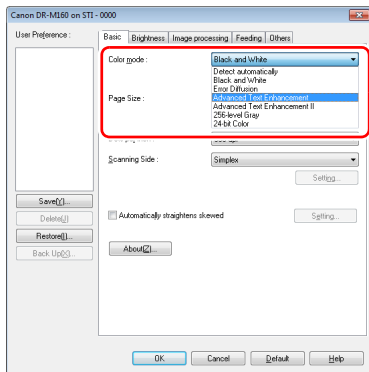

- Advanced Text Enhancement is suitable for a document with a light background color or a document with a non-uniform background (such as a pattern). If the background is uniform, it is removed where it surrounds the text, and if the background is non-uniform, it is processed to enhance text readability.
- Advanced Text Enhancement II is suitable for scanning a document with a uniform background color and light text and background. If the background is non-uniform, such as a pattern, the background may not be able to be completely removed and the text may become difficult to read. If necessary, you can make the text in scanned images easier to read by adjusting the contrast on the [Brightness] tab.

Mac

Select [Advanced Text Enhancement II] in the [Color mode] setting. The background behind the text is removed or processed so that the text is emphasized for better readability.

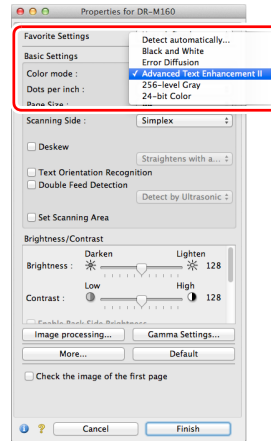

When you want to detect multiple pages fed at the same time

Windows

Select the [Double Feed Detection] check box on the [Feeding] tab. You can enable either one or both of [Detect by Ultrasonic] and [Detect by Length].

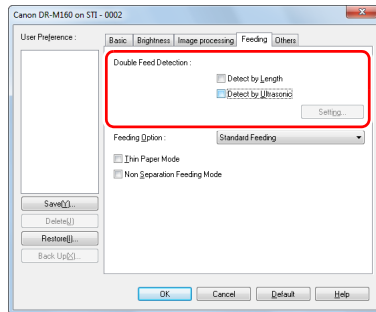

Mac

Select the [Double Feed Detection] check box.

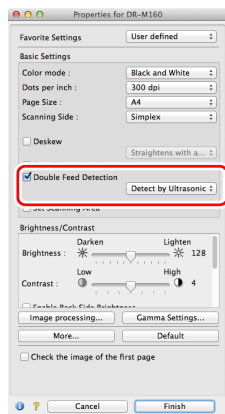

When you want to match the orientation of images to the text when scanning a mixture of pages with different text orientations

Windows

Select [Text orientation recognition] in [Document Orientation] on the [Others] tab. The text orientation on each page is detected, and the scanned image is rotated in 90-degree increments to correct the orientation.

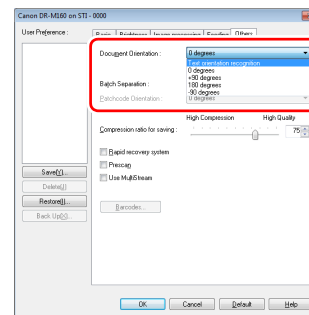

Mac

Select the [Text Orientation Recognition] check box. The text orientation on each page is detected, and the scanned image is rotated in 90-degree increments to correct the orientation.

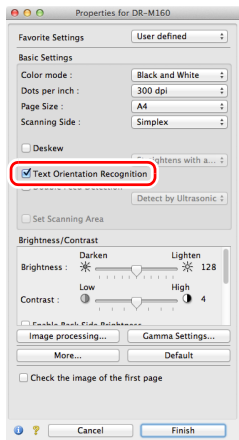

Hint

When the [Text Orientation Recognition] check box is selected, [Document Orientation] is unavailable.

When you want to rotate the images of a document placed horizontally to correct the orientation

Windows

Specify the rotation angle in [Document Orientation] on the [Others] tab.

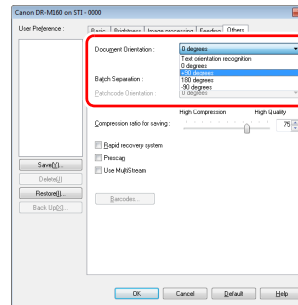

Mac

Click [Image processing] and specify the rotation angle in [Document Orientation] in the dialog box that appears.

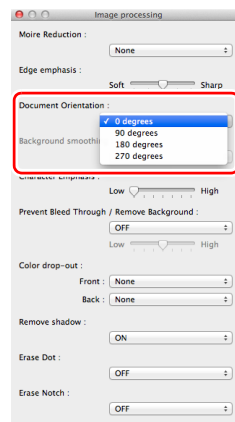

When you want to use batch separation for scanning

Windows

When you want to divide and scan a document, you can separate a batch at the timing with which each next document is placed and scanned. (Only enabled for applications that support batch separation.) In this case, set the scanner driver as follows.

- Set [Feeding Option] on the [Feeding] tab to [Panel-Feeding] or [Automatic Feeding].

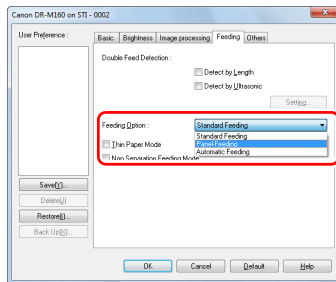

- Set [Batch Separation] on the [Others] tab to [Auto].

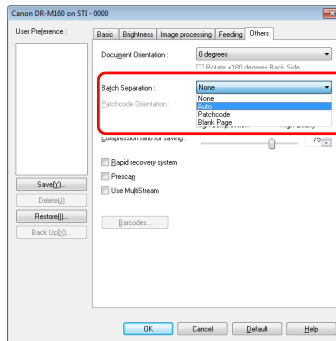

When [Batch Separation] is set to [Auto], the batch is separated after the next document is placed and scanning is continued.

For more details about [Blank Page] and [Patchcode], see [“Batch Separation” on p. 77](#)

When you want to use multistream settings for scanning

Windows

Multi-stream allows you to output multiple different scanned images with a single scan operation, and output scanned images with different scanning conditions for each of the front and back pages (multistream settings).

When you want to use the multistream settings for scanning, select the [Use MultiStream] checkbox on the [Others] tab to display the setting items related to multistream, and then configure the setting items in the following order.

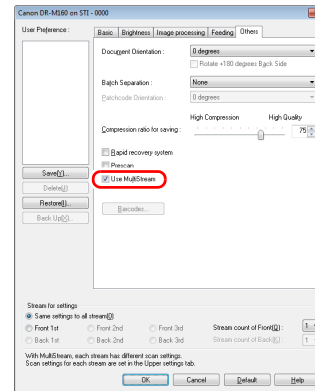

- ① When you want to specify different scanning conditions for the front and back pages of a document, select [Skip Blank Page] or [Both] for [Scanning Side] on the [Basic] tab in advance.
- ② Specify the number of scanning conditions to apply in [Stream count of Front]. Up to three can be specified.
- ③ Select [Front 1st], and then open the other tabs and set the scanning conditions. Depending on the value specified for [Stream count of Front], configure the remaining [Front 2nd] and [Front 3rd] in the same way.
- ④ When specifying the scanning conditions of the back, configure the settings in the same way as described in ② to ③. In this case, specify [Stream count of Back], and then set the scanning conditions for each of [Back 1st] to [Back 3rd].



Hint

The following shows the setting conditions that can be set in the multistream settings.

Tab	Items that can be set
[Basic] tab	[Color mode] and [Dots per inch] (excluding [Auto-detection] for both)
[Brightness] tab	[Brightness] and [Contrast]
[Image processing] tab	[Edge emphasis], [Color dropout], and [Character Emphasis]
[Feeding] Tab	None (all disabled)
[Others] Tab	None (only [Use MultiStream] is enabled)

To scan barcodes

Windows

Installing a barcode module (optional) allows you to scan barcodes in the document. Click the [Barcode] button on the [Others] tab to configure barcode scanning conditions. See Help for details about settings.

When you want to remove dots and notches that appear in documents

Windows

You can remove dots and notches protruding from object outlines that appear in documents from scanned images.

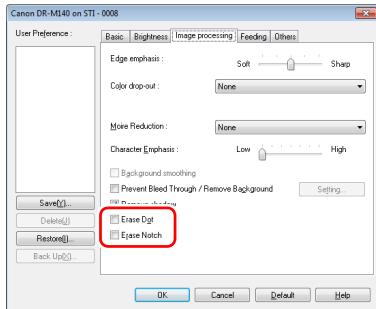

- Select the [Erase Dot] check box to automatically remove isolated black dots (3 x 3 dot size) from white backgrounds (or white dots from black backgrounds).
- Select the [Erase Notch] check box to remove notches that protrude from object outlines in scanned images.

Mac

Click [Image processing] and select [ON] for [Erase Dot] or [Erase Notch] in the dialog box that appears.

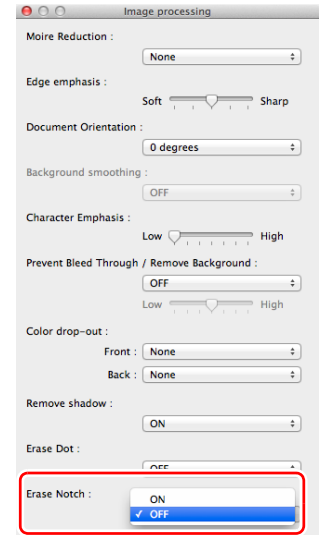
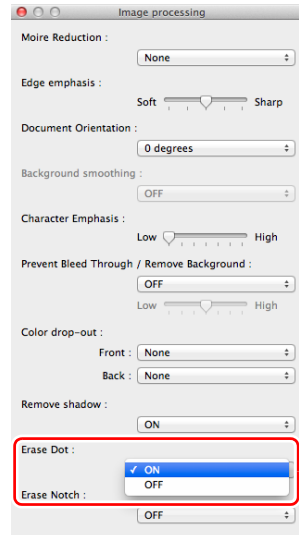

- When [ON] is selected for [Erase Dot], the isolated 3x3 black dots on white backgrounds (or isolated 3x3 white dots on black backgrounds) are erased automatically.
- When [ON] is selected for [Erase Notch], the portions (notches) protruding outside the contours are erased from the scanned images.

When you want to save a scanner driver setting



When you finish configuring a setting, click the [Save] button of [User Preference] to save the setting.

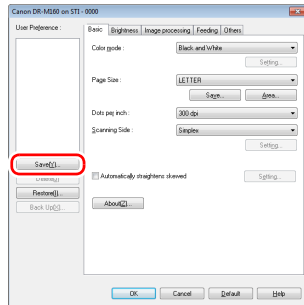

The saved setting is registered to the list. You can delete a setting from the list with the [Delete] button, and save or load a configuration file with the [Back Up] or [Restore] button.



When you finish configuring a setting, select [Add/Delete] of [Favorite Settings] to save the setting.

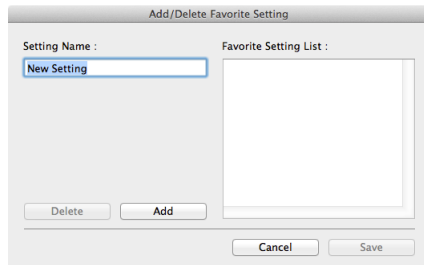

Clicking the [Add] button registers the current setting to [Favorite Setting List]. Use the [Delete] button to delete a setting from the list.

Function Restrictions Depending on Color Mode Setting

→ Windows

→ Mac

Windows

Some of the setting items in each of the driver tabs are disabled as follows depending on the setting for [Color Mode] on the [Basic] tab.

[Brightness] tab

Setting value	Contrast
Detect Automatically	O
Black and White	O
Error Diffusion	O
Advanced Text Enhancement	X
Advanced Text Enhancement II	O
256-level Gray	O
24-bit Color	O

(O: Available for setting, X: Not available for setting)

[Others] Tab

Setting value	Prescan
Detect Automatically	X
Black and White	O
Error Diffusion	O
Advanced Text Enhancement	O
Advanced Text Enhancement II	O
256-level Gray	O
24-bit Color	O

(O: Available for setting, X: Not available for setting)

[Image processing] tab

Setting value	Edge emphasis	Color drop-out	Background smoothing	Prevent Bleed Through / Remove Background	Erase Dot	Erase Notch	Character Emphasis
Detect Automatically	O	X	O	O ¹⁾	O ²⁾	O ³⁾	O ³⁾
Black and White	O	O	X	O	O	O	O
Error Diffusion	O	O	X	O	X	O	O
Advanced Text Enhancement	O	O	X	X	O	O	O
Advanced Text Enhancement II	X	O	X	X	O	O	O
256-level Gray	O	O	O	O	X	X	X
24-bit Color	O	X	O	O	X	X	X

(O: Available for setting, X: Not available for setting)

¹⁾Not available for setting if all of the following conditions in the [Auto Image Type Detection Settings] dialog box are met.

- [Detection mode] is not set to [Color or Gray]
- [Mode in case of binary] in the [Settings for in case of binary] tab is set to [Advanced Text Enhancement] or [Advanced Text Enhancement II]

²⁾Not available for setting if either one of the following two conditions are met.

- [Detection mode] in the [Auto Image Type Detection Settings] dialog box is set to [Color or Gray]
- [Mode in case of binary] in the [Settings for in case of binary] tab is set to [Error Diffusion]

³⁾Not available for setting if [Detection mode] is set to [Color or Gray] in the [Auto Image Type Detection Settings] dialog box.



Some of the setting items are disabled as follows depending on the setting for [Color Mode] in the settings screen of the scanner driver.

Simple Mode

Setting value	Check the image of the first page
Detect automatically	X
Black and White	O
Error Diffusion	O
Advanced Text Enhancement II	O
256-level Gray	O
24-bit Color	O

O: Available for setting X: Not available for setting

Advanced Mode

Setting value	Enable Back Side Brightness	Enable Back Side Contrast	Check the image of the first page
Detect automatically	O	O	X
Black and White	O	O	O
Error Diffusion	O	O	O
Advanced Text Enhancement II	X	X	O
256-level Gray	O	O	O
24-bit Color	O	O	O

O: Available for setting X: Not available for setting

Advanced mode (Image processing dialog)

Setting value	Edge emphasis	Background smoothing	Character Emphasis	Prevent Bleed Through / Remove Background	Color drop-out	Erase Dot	Erase Notch
Detect automatically	O	O ¹⁾	X	X	X	X	X
Black and White	O	X	O	O	O	O	O
Error Diffusion	O	X	O	O	O	O	O
Advanced Text Enhancement II	X	X	O	X	O	O	O
256-level Gray	O	O	X	O	O	X	X
24-bit Color	O	O	-	O	O	X	X

O: Available for setting X: Not available for setting

1) Cannot be set if the [Detect automatically] setting matches the conditions below

- [Detection Mode] is not set to [Color or Gray]

More Advanced Scanning Methods (Batch Separation)

Batch Separation (Insert blank page)

Recognizes blank pages as batch separators and performs batch separation (automatic file separation) when documents containing blank pages are scanned.

On the [Others] tab of the ISIS driver properties, select [Blank Page] from the Batch Separation dropdown list.

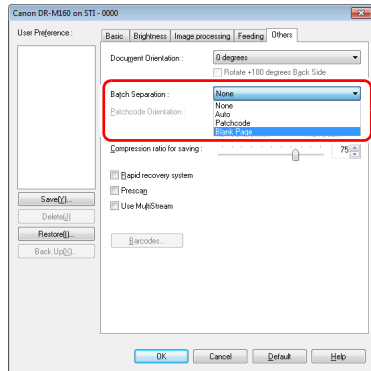

! IMPORTANT

- When [Simplex] is selected in [Scanning Side], blank pages on the scanned side will be recognized as separators. When [Duplex], [Skip blank page], or [Folio] is selected in [Scanning Side], document pages will be recognized as separators when both sides of a page are blank.
- Images of pages recognized as separators will not be saved.

Batch Separation

By tucking patchcode sheets supplied with this scanner into a document and scanning it, the scanner can automatically separate files by images of documents containing patchcode sheets (or documents after the patchcode sheet).

💡 Hint

- This function can be used with the supplied CapturePerfect software. Other applications that support this function include ISIS-compatible applications. It is not supported by TWAIN-compatible applications.
- Patchcodes are included with this product in PDF format. Applications that can read PDF files such as the supplied CapturePerfect are required to use this function.

The following patchcodes are installed together with the scanner driver as PDF files.

Type of Patchcode	Pattern	Description
PATCH (FILE A)		Files are separated from the page after the page printed with this patchcode. You specify in the application whether to include the page printed with the patchcode in the scanned image.
PATCH II (FILE B)		Files are separated from the page printed with this patchcode. The page with the printed patchcode is always included in the scanned image.

The following operations are performed when using patchcodes for scanning.

1 Print patchcode with a printer.

Click [Start] – [All Programs] – [Canon DR-M160] and then select [Patchcode] from the menu.

Patchcodes can be printed in A4 and letter (LTR) sizes. Open the application and print a patchcode that is the same size as the document to be scanned.

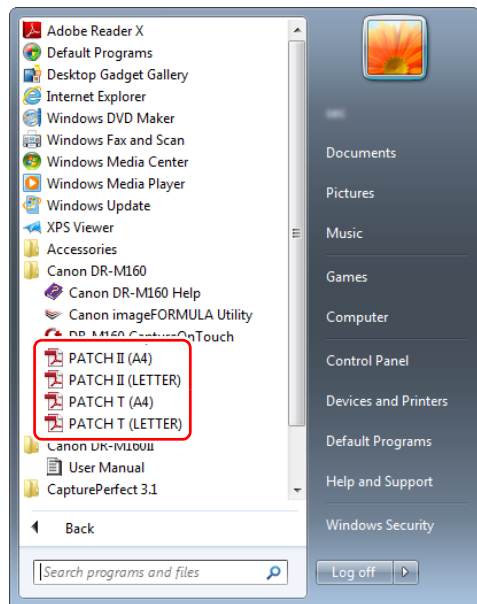

Hint

In Windows 8.1/8, it is registered at the following location.

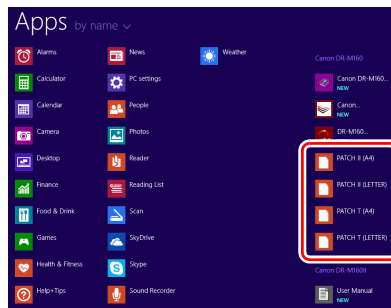

! IMPORTANT

- Patchcodes must be printed in their normal size. If patchcodes are enlarged or reduced, they may not be recognized correctly.
- When copying provided patchcodes to create different sized patchcodes, ensure that the patchcode fits inside the effective range shown in the following diagram. Also, when copying patchcodes, ensure that they are the same size and shade as the original.

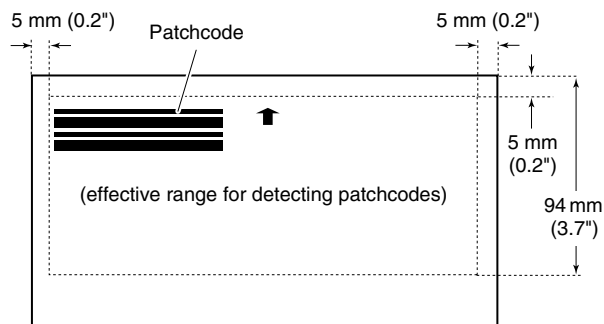

- Keep the patchcode sheet clean. Take particular care to keep the patchcode detection range area clean. Also, do not bend, fold or crease the sheet.

- 2** Place the documents in the scanner after inserting the patchcode sheet in front of the page that separates the files.

Insert the patchcode sheets at the beginning of documents to change file separation.

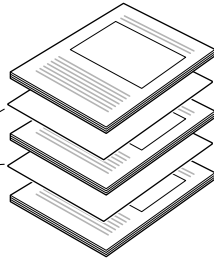

- 3** In an application, specify a patchcode as a type of batch separation.

When using CapturePerfect, select [Patchcode] in the [Batch Separator] settings.

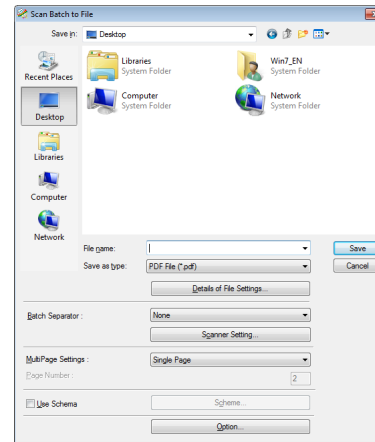

When using other ISIS-compatible applications, open the scanner driver settings screen and select [Patchcode] in [Batch Separation] on the [Others] tab.

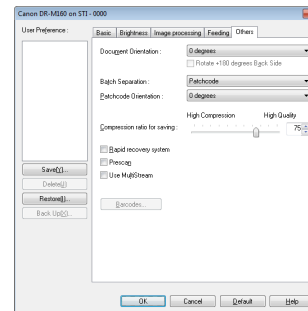

Daily Maintenance

Clean the scanner on a regular basis, as described below, to maintain peak scanning quality.

CAUTION

- When cleaning the scanner and the inside of the scanner, turn OFF the power switch and disconnect the power cord from the power outlet.
- Do not use spray cleaners to clean the scanner. Precision mechanisms, such as the light source, may get wet, and cause a malfunction.
- Never use paint thinner, alcohol, or other organic solvents to clean the scanner. The exterior of the scanner may become deformed, discolored, or melted. It may also cause a fire or electric shock.

Cleaning the Scanner

To clean the outside of the scanner, wipe off any dirt with a cloth that has been dampened with water and thoroughly wrung out, and then wipe the scanner dry with a clean dry cloth.

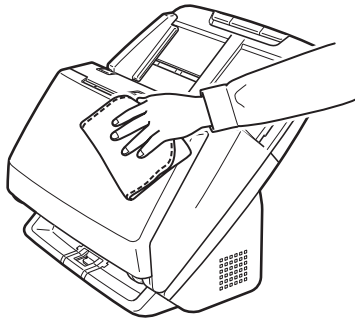

Cleaning the Inside of the Scanner

Dust or paper particles inside the scanner may cause lines or smudges to appear on scanned images. Use compressed air to periodically clean dust and paper particles from the document feed opening and the inside of the scanner. After finishing a large scanning job, turn OFF the scanner and then clean out any paper particles remaining inside the scanner.

Cleaning the Sensor Glass and the Rollers

If scanned images contain streaks, or if the scanned documents become dirty, the sensor glass or rollers inside the scanner may be dirty. Clean them periodically.

- 1 Open the document eject tray.

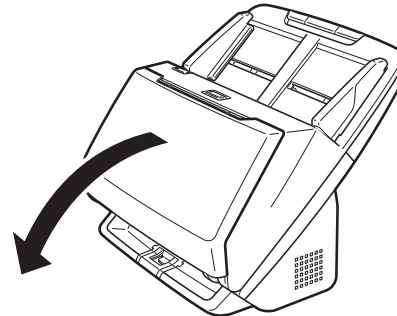

-
- 2** Pull the OPEN lever and pull open the front unit toward you.

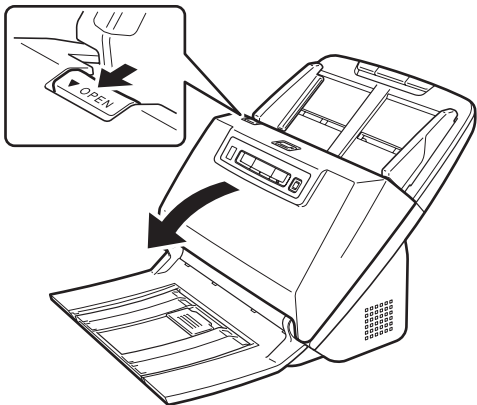

-
- 3** Use compressed air to remove dust and paper particles from the inside of the scanner.

-
- 4** Wipe any dirt off the scanning glass.

Wipe any dirt off the scanning glass with a cloth that has been dampened with water and thoroughly wrung out, and then wipe the glass dry with a clean, dry and soft cloth.

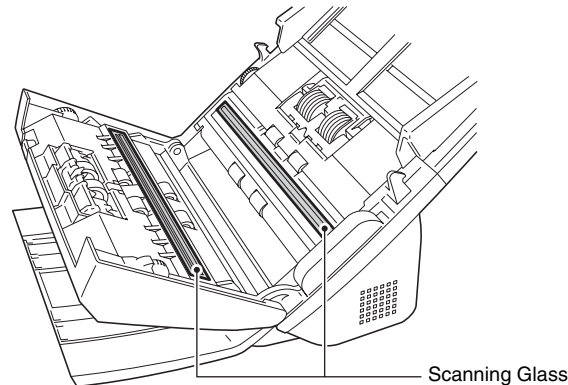

⚠ CAUTION

Do not spray water or neutral detergent directly on the scanner. Precision mechanisms, such as the light source, may get wet, and cause a malfunction.

! IMPORTANT

- Scratches on the sensor glass may cause marks on the images, as well as feeding errors. If there are scratches on the sensor glass, contact your local authorized Canon dealer or service representative.
- Take care to ensure the anti-static brush in the front unit does not become deformed.

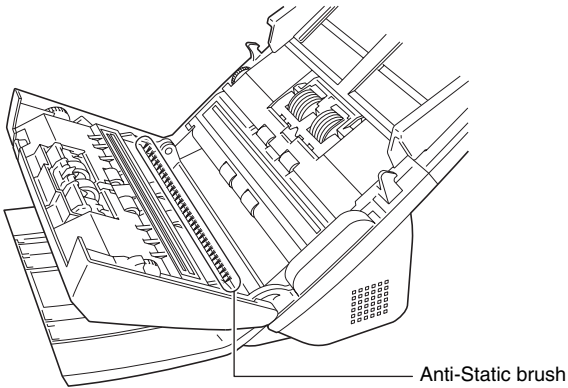

5 Clean the rollers.

Clean the rollers while turning them.

Wipe the rollers with a cloth that has been dampened with water and thoroughly wrung out, and then use a clean, dry and soft cloth to wipe away any moisture.

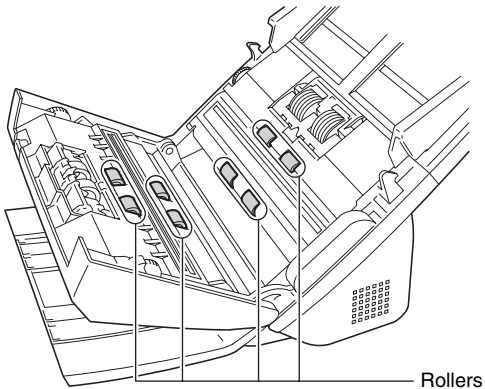

6 Remove the retard roller and feed roller. (See p. 86, p. 87)

! IMPORTANT

Remove the retard roller and feed roller from the scanner to clean them, and be sure to reattach them to the scanner when cleaning is finished.

7 Wipe the removed rollers with a cloth that has been dampened with water and thoroughly wrung out.

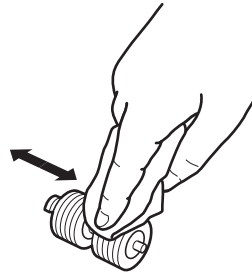

8 Reattach the retard roller and feeding roller. (See p. 86, p. 87)

- 9** Close the front unit by gently pushing it up on both sides until it clicks into place. Make sure that the front unit is completely closed by pushing until you hear a click.

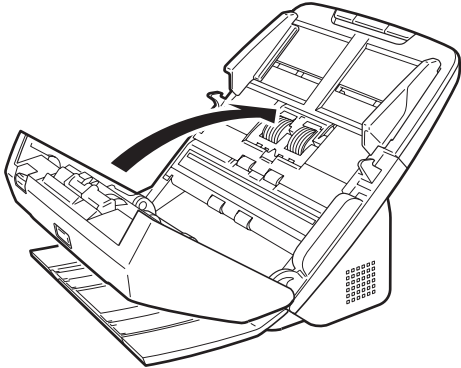

- 10** Close the document eject tray.

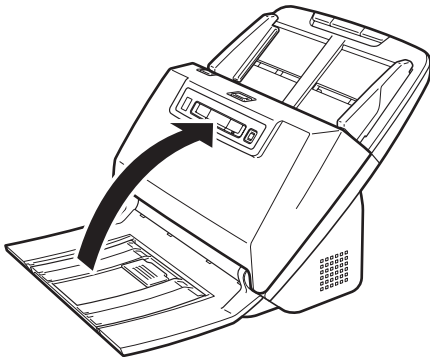

Adjusting the Reduction Ratio

As the rollers installed in the scanner wear out, scanned images may become stretched in the vertical direction. If this happens, you can reduce the amount of stretching of the image by adjusting the reduction ratio.

! IMPORTANT

Log on to Windows as an Administrator.

Windows

- 1** Click the Start button, and then click [All Programs], [Canon DR-M160], and [Canon imageFORMULA Utility]. imageFORMULA Utility starts.

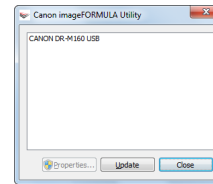

💡 Hint

In Windows 8.1/8, it is registered at the following location.

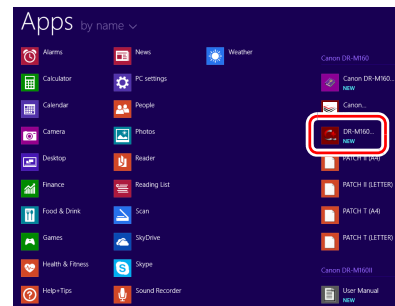

2 Click [Canon DR-M160 USB] and click [Properties].

Scanner properties are displayed.

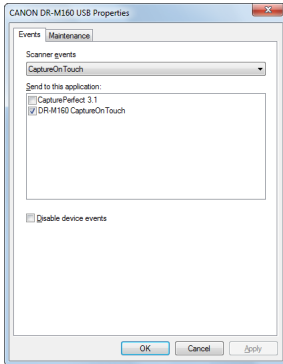

3 Click the [Maintenance] tab and then change the value of [Reduction ratio adjustment].

The adjustment value can be set within the range from -3.0% to 3.0%.

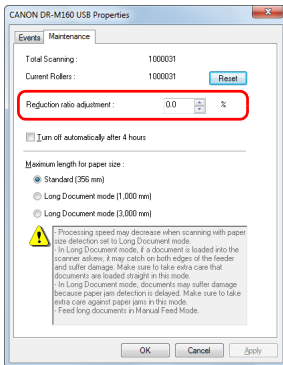

4 Click [OK] to close the scanner properties.

Mac

1 Opens the scanner driver's Detail Settings screen. (See p. 47)

2 Click ⓘ to display the [Scanner Information] dialog box.

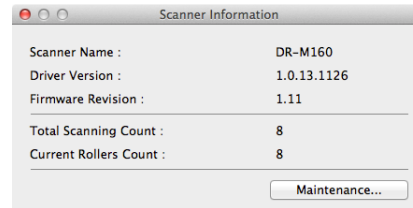

3 Click [Maintenance] to display the [Maintenance] dialog box.

4 Change the value of [Reduction ratio adjustment].

The adjustment value can be set within the range from -3.0% to 3.0%.

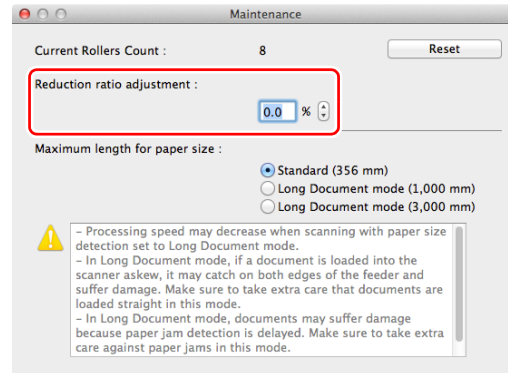

5 Click ⓧ to close the dialog box.

Replacing Consumable Parts

The two rollers (feed roller and retard roller) installed in the scanner are consumable parts. The feed roller and retard roller wear with scanning. If the feed roller and retard roller are worn, documents may not feed correctly and paper jams and double feeds may occur. When more than 200,000 pages have been fed (total number of pages fed by the scanner), a message prompting you to replace the rollers is displayed when the computer is started.

Windows

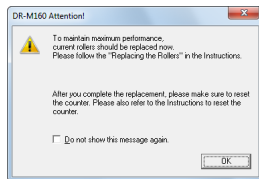

Mac



If this message begins to be displayed at startup, purchase an exchange roller kit and replace the worn parts with the consumable parts included in the kit (feed roller and retard roller). [See p. 102](#) for details about the exchange roller kit.

Furthermore, the counter in the scanner that records the number of pages fed also needs to be reset when you replace the rollers. ([See p. 88](#))

Hint

Even before it becomes time to replace the rollers, scanned images may become stretched in the vertical direction due to wear of the rollers. If this happens, adjust the reduction ratio. ([See p. 83](#))

Opening and Closing the Front Unit

- 1 Open the document eject tray.

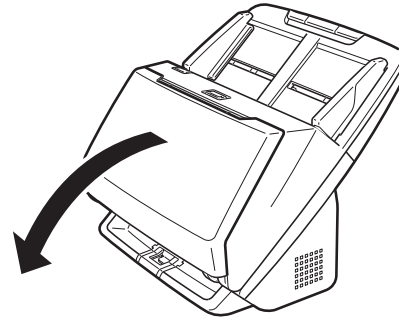

- 2 Pull the OPEN lever and pull open the front unit toward you.

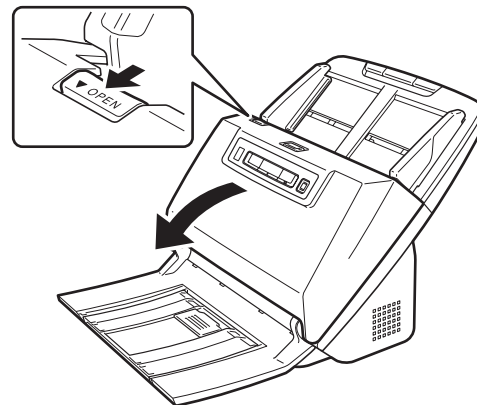



Hint

The location of each of the consumable parts is shown below.

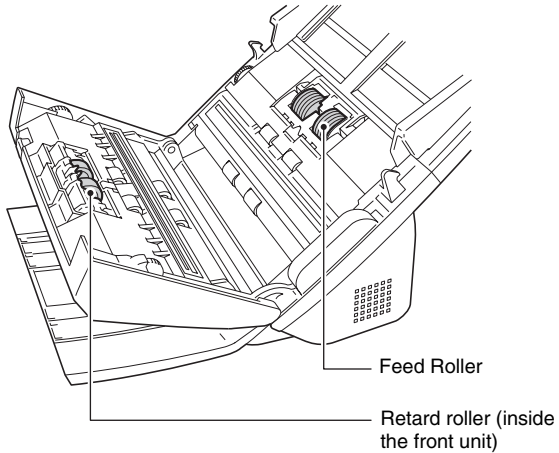

- 3** When closing the front unit, make sure that it is completely closed by gently pressing the left and right until you hear a click.

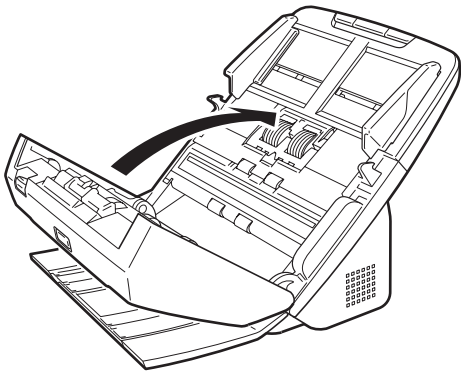

- 4** Close the document eject tray.

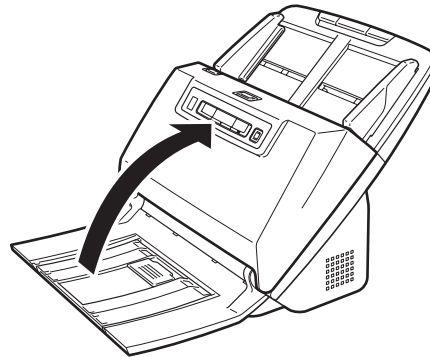

Replacing the Feed Roller

- 1** Open the roller cover.

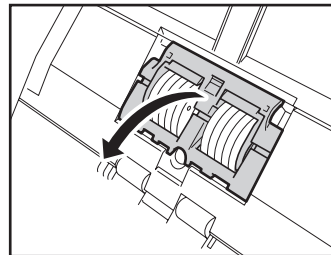

2 Remove the feed roller.

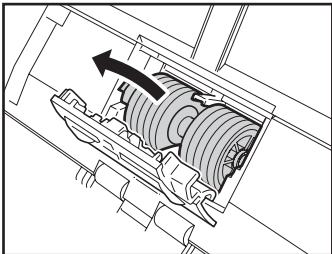

3 Install the new feed roller.

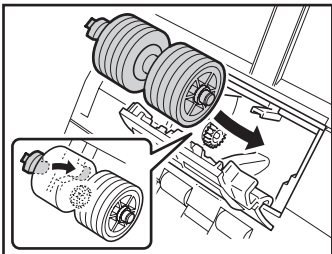

4 Close the roller cover.

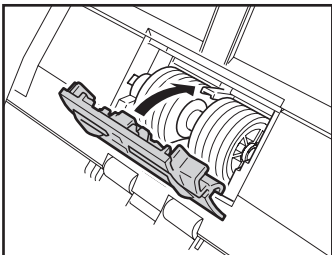

Replacing the Retard Roller

1 Open the roller cover.

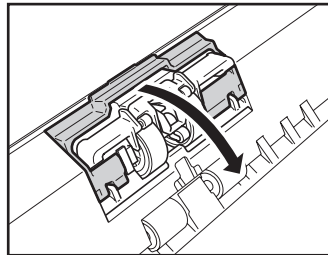

2 Pull the left lever that secures the retard roller to the scanner, and remove the roller.

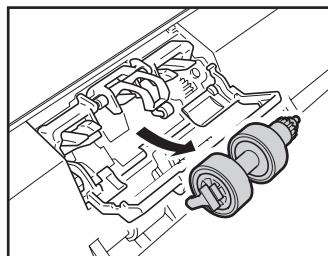
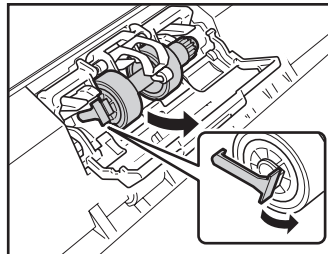

- 3** Install the new retard roller by inserting the right side first.

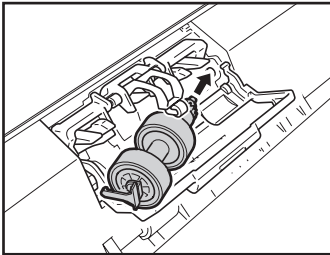

- 4** Push the left side of the retard roller to secure it to the scanner.

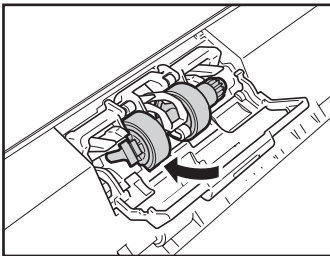

- 5** Close the roller cover.

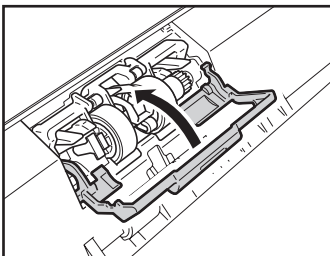

Resetting the counter

! IMPORTANT

Log on to Windows as an Administrator.

Windows

- 1** Click the Start button, and then click [All Programs], [Canon DR-M160], and [Canon imageFORMULA Utility]. imageFORMULA Utility starts.

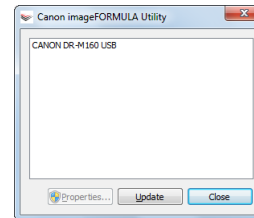

💡 Hint

In Windows 8.1/8, it is registered at the following location.

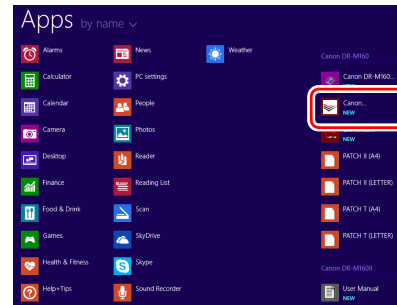

- Click [Canon DR-M160 USB] and click [Properties].
Scanner properties are displayed.

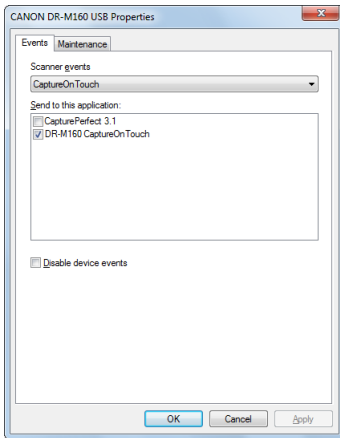

- Click the [Maintenance] tab and then select [Reset].

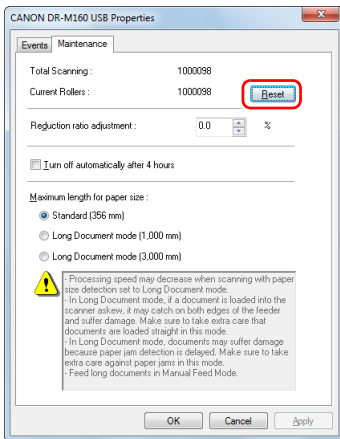

The counter for [Current Rollers] resets.

- Click [OK] to close the scanner properties.

Mac

- Opens the scanner driver's Detail Settings screen. (See p. 47)

- Click to display the [Scanner Information] dialog box.

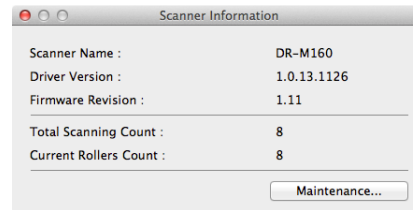

- Click [Maintenance] to display the [Maintenance] dialog box.

- Click [Reset].

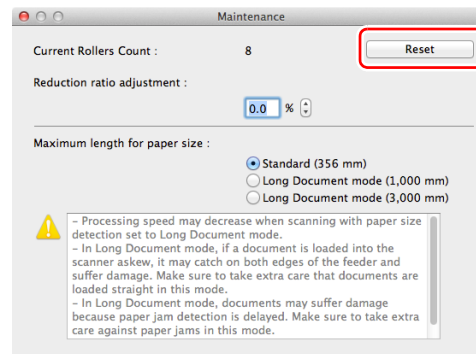

- Click to close the dialog box.

Auto Power Off Setting

The scanner automatically turns off if 4 hours elapse without scanning or another operation being performed.

To disable this setting, follow the procedure below.

Windows

! IMPORTANT

Log on to Windows as an Administrator.

- 1 Click the Start button, and then click [All Programs], [Canon DR-M160], and [Canon imageFORMULA Utility]. imageFORMULA Utility starts.

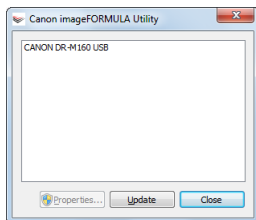

Hint

In Windows 8.1/8, it is registered at the following location.

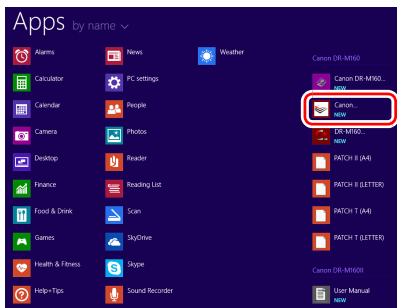

- 2 Click [Canon DR-M160 USB] and click [Properties]. Scanner properties are displayed.

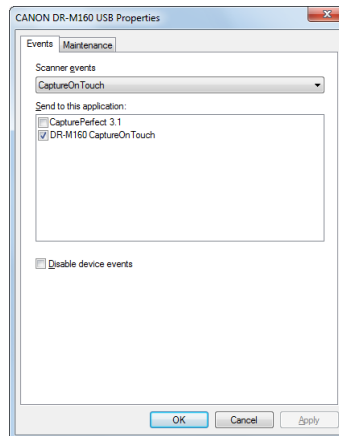

- 3 Click the [Maintenance] tab and then clear the [Turn off automatically after 4 hours] check box.

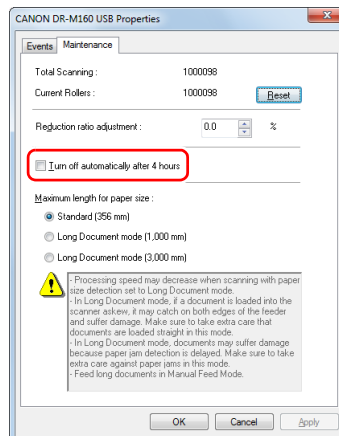

4 Click [OK] to close the scanner properties.

Removing the Document Feed Tray

When you will store or otherwise not use the scanner for a long period of time, remove the document feed tray.

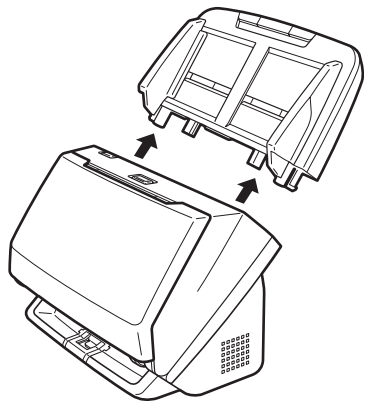

Common Problems and Solutions

This section provides recommended solutions to common problems. If you have a problem that is not solved by the following, contact your local authorized Canon dealer.

Problem 1 The scanner will not turn on.

Solutions Confirm that the AC adapter is plugged firmly into a power outlet.

Problem 2 The scanner is not recognized.

Solutions

- (1) Confirm that the scanner is properly connected to the computer with a USB cable.
- (2) Confirm that the scanner is turned on. See the previous problem (1) if the scanner does not turn on.
- (3) The computer's USB interface may not support the scanner. The scanner cannot be guaranteed to work with all USB interfaces.
- (4) Confirm that the supplied USB cable is used to connect the scanner to the computer. The scanner cannot be guaranteed to work with all available USB cables.
- (5) If the scanner is connected to the computer via a USB hub, try removing the hub and connecting directly to the computer.

Problem 3 Documents feed askew (scanned images are slanted).

Solutions

- (1) Align the document guides to fit the documents as closely as possible, and load the documents so that they feed straightly.
- (2) Open the document feed extension support and place the document.
- (3) Enable [Automatically straightens skewed] (or [Deskew]) in the scanner driver settings.
- (4) If many pages have been scanned since roller cleaning, clean the rollers. If documents still feed askew, roller replacement or other maintenance may be needed. See ["Maintenance" on p. 80](#) for roller replacement procedures.

Problem 4 Both sides are not scanned even when the Duplex scanner driver setting is enabled.

Solutions When you scan using a job registered with CaptureOnTouch, the registered job settings have priority over the scanner driver settings. Edit existing job settings, or create a new job using the desired scanning conditions.

Problem 5 If white lines or streaks appear in scanned images.

Solutions Clean both sides of the scanner glass, and the rollers. If a sticky substance such as glue or correction fluid is found, carefully wipe with just enough pressure to clean the area where the lines appear. If the problem cannot be solved by cleaning, the internal glass may be scratched. Contact your local authorized Canon dealer.

Problem 6 Pages are missing.

Solutions When the scanner driver's [Scanning Side] setting is [Skip Blank Page], documents with very little black may be unintentionally skipped. Decrease the Set the likelihood of skipping blank page value ("When you want to delete the images of the blank pages in two-sided documents" on P. 59) or set the [Scanning Side] to another mode, such as simplex or duplex. If pages are skipped due to the document double feeding, see "Problem 7 Documents jam (or double-feed)."

Problem 7 Documents jam (or double-feed).

Solutions (1) If the roller has been installed correctly, clean it if necessary.
 (2) Proper scanning may not be possible when document pages stick together due to static electricity. Fan the documents before you load them.
 (3) Set the scanner to non separation mode, and manually feed the scanner one page at a time.

Problem 8 Scanned images are saved in TIFF instead of JPEG format.

Solutions When documents are scanned with CapturePerfect while [Color Mode] is set to [Detect automatically] in the scanner driver, documents detected as black and white are automatically saved in TIFF format, even if the file type is specified as JPEG format. This occurs because JPEG format does not support black and white binary format images. If you want to save all images in JPEG format, change the scanning [Color Mode] to either [24-bit Color] or [256-level Gray].

Problem 9 Multiple pages of scanned images cannot be saved to a single file.

Solutions • Depending on the file format, multiple scanned image pages cannot be saved as a single file with CaptureOnTouch.

File type	Processing for multiple pages
BMP (Windows only), JPEG	Scanned images are always saved one page per file.
PPTX (Windows only)	Multi-page images are always saved to a single file.
TIFF, PDF	You can save multiple pages to a single file by clicking  and selecting [Save all pages as one file] in the displayed dialog box.

• When you select [Scan Batch to File] from the [Scan] menu in CapturePerfect, a dialog box appears with a [Multi Page Settings] pull-down that allows you to select [Single Page]. If you select [Single Page] here, each page of a multi-page document is saved as a separate image file. To save multiple pages to a single image file, select [Multi Page (All Pages)].

Problem 10 All of the placed documents have been scanned, but the scanned image does not appear on the application.

Solutions When [Panel-Feeding] or [Automatic Feeding] is selected as the feeding method on the scanner driver's Detail Settings screen, a scanning operation will not continue after all of the documents are fed, as the scanner awaits additional documents to be fed. You can finish the operation and send the scanned images to the application by pressing the Stop button on the operating panel.

Problem 11 Memory becomes insufficient and scanning stops.

Solutions If you configure scanning conditions that use a large amount of the computer's memory, scanning may stop because of insufficient memory. Although this depends on the computer's memory size, the possibility of insufficient memory increases if any of the following scanning conditions overlap.

- [Color Mode] is set to [24-bit Color]
- A large page size (e.g. Legal) is specified as the [Page Size]. Alternatively, the page size is set to [Scanner's Maximum].
- A high resolution (600dpi etc.) is specified for [Dots per inch].

If an error message appears due to insufficient memory while scanning is in progress, exit the application, change the scanning conditions (e.g. reduce the resolution or page size) and then try scanning again. In addition, the amount of memory used can be contained by turning off [Moire Reduction] and [Prevent Bleed Through/Remove Background] if they are set to on.

Software Troubleshooting

This section describes troubleshooting problems and solutions for operating the supplied software (CaptureOnTouch and CapturePerfect).

If scanning is too slow

- (1) Close other running programs, if any.
- (2) Scanning can be slowed down by memory shortage caused by memory-resident applications such as anti-virus programs. Close such memory-resident programs if necessary to free up memory space.
- (3) When insufficient hard disk space is available, the scanner may be unable to create the necessary temporary files for scanned data. Delete unneeded data on the hard disk to free up more space.
- (4) Scanning is slow if the computer's USB port is not Hi-Speed USB 2.0 compliant.
- (5) If using a common USB cable that is not Hi-Speed USB 2.0 compliant, replace the cable with the supplied compliant cable.
- (6) When the scanner is connected to the computer via a USB hub that is not Hi-Speed USB 2.0 compliant, remove the hub and connect the scanner directly to the computer.

If scanned image files cannot be opened in an application

- (1) Scanned images saved as multi-page TIFF files can be opened only by programs that support this file format.
- (2) Images saved as compressed TIFF files (single- as well as multi-page) can only be opened by programs that support the compressed format. This can occur with programs that are not compatible with CaptureOnTouch or CapturePerfect. In this case, select "None" as the image file compression format before scanning.

Useful tips

Here are some useful tips for scanning documents.

Where are scanned images saved? Can the save destination be changed?

Images are saved to the following locations, according to program settings.

For example, save locations such as the following can be set in CaptureOnTouch.

CaptureOnTouch

- For Scan First scanning, files are saved in the folder specified on the Output Settings screen.
- For selected job scanning, files are saved in the folder specified on the [Output setting] during job registration.

CapturePerfect

- During normal scanning operations such as single-page scanning, the image file save destination can be specified each time scanning is performed.
- When scanning using a registered job, files are saved to the folder specified by the job settings.

How are the scan settings configured?

CaptureOnTouch

- For Scan First scanning, click [Scanner setting] on the first (top) screen to display available scan settings.
- For selected job scanning, click [Scanner setting] during job registration to display available scan settings.

CapturePerfect

- For normal scanning, click [Scanner Setting] from the [Scan] menu to open the scanner driver setting screen, and make settings there.
- Scan job settings are made for each job.

How do I save multiple pages in one file, or save one file per page?

When scanned images are saved in BMP (PICT) or JPEG format, each image is always saved in a separate file.

When scanned images are saved in PDF or TIFF format, you can specify multi- or single-page files. See also “Problem 9” in “Common Problems and Solutions”.

Can I copy or back up scanner setting configurations?

CaptureOnTouch

Scanner settings are backed up from the Environment settings. See also the following question, “Can I copy or back up CaptureOnTouch settings?”.

CapturePerfect

Scanner setting configurations cannot be copied or backed up in CapturePerfect.

Can I copy or back up CaptureOnTouch settings?

The setting configurations can be backed up and restored using [Back Up/Restore] on the [Basic settings] tab on the [Environmental settings] dialog box.

What rules apply to scanned image file names?

In CaptureOnTouch, scanned image file names are constructed according to the settings in the [File name settings] dialog box. This dialog box appears when you click  on the [File name] on the Scan First output settings screen, and on the [Output setting] tab on the Register new job screen.

Scanned image file names are constructed partly or wholly according to the following three settings in the dialog box.

Setting	Description
Start file name with character string	Any specified text string to be included in the file name.
Add date and time	Appends the date and time to file names. Select the date format from the list box. YYYY = year, MM = month, and DD = day of month. The time is appended after the date.
Add counter to file name	Append serial numbers in the order of scanned image saving. Specify the number of digits and starting number.

A sample file name is displayed as the [File name] in the [File name settings] dialog box.

CapturePerfect

The rules for the file names of scanned images and the folder in which scanned images are saved can be set and then applied during scanning. For details, see the “Operating Guide” or help of CapturePerfect.

How do I scan half-folded documents (folio scanning)?

Fold the document in half, and set it in the scanner with the fold at the right. Specify half-size document (the size after folding) and select [Folio] for the [Scanning side], select [Non Separation Feeding Mode] in the [Feeding] tab, then scan. For details, [see p. 30](#).

How can I skip blank pages, and scan only non-blank pages?

Specify [Skip Blank Page] on the scanner driver setting screen, then scan.

How do I scan cards?

Set a card in landscape orientation in the scanner. Specify the same size as the card (or [Match original size]), then scan. For details, [see p. 29](#).

Is it possible to add or insert images in a scanned image file?

CapturePerfect includes a function to add or insert pages in scanned image files. Refer to the CapturePerfect Operation Guide for details.

How do I paste OCR results from CapturePerfect into Excel or Word?

After scanning with OCR recognition enabled in CapturePerfect, click [Modify Barcode/OCR] in the [Edit] menu to open the [Modify Barcode/OCR] dialog box, where you can copy the text in the [OCR Characters] box. Alternatively, PDF files that were scanned with OCR enabled can be opened with an application, where the desired text can be copied.

How do I load and scan documents with mixed sizes?

Set [Page Size] to [Match original size] (or [Detect automatically]) on the scanner driver setting screen, then scan. For details, [see p. 60](#) ([see p. 62](#)).

What is the best way to scan business cards or photos?

Set [Page Size] to [Match original size] (or [Detect automatically]) on the scanner driver setting screen, then scan. Alternatively, register the size of the cards or photos to be scanned. For details, [see p. 29](#).

How do I print scanned data?

CaptureOnTouch

- For Scan First scanning, select [Print] on the Output Method selection screen.
- For selected job scanning, select [Print] as the [Output method selection] when registering the job.

CapturePerfect

Scan using the [Scan Batch to Printer] function. Alternatively, register a job with a printer selected as the output destination.

How do I save scanned data in a shared folder?

CaptureOnTouch

- For Scan First scanning, select [Save to folder] on the output method selection screen, and specify the shared folder as the save destination on the Output Setting screen.
- For selected job scanning, select [Save to folder] in [Output method selection] during job registration, and specify the shared folder as the save destination on the Output Setting screen.

CapturePerfect

Scan using the [Scan Batch to File] (or [Scan Page]) function. Alternatively, register a job with the output destination as a file, and set the save destination to the shared folder.

How can I attach scanned data to an e-mail (or send it as e-mail)?

CaptureOnTouch

- For Scan First scanning, select [Attach to E-mail] on the output method selection screen.
- For selected job scanning, select [Attach to E-mail] as the [Output method selection] when registering the job.

CapturePerfect

Scan using the [Scan Batch to Mail] function. Alternatively, register a job with the output destination as e-mail.

Clearing a Paper Jam

When paper jams are detected during scanning, the following error codes are displayed in the scanner's display panel and scanning is interrupted.

 Paper jam error code

When a paper jam or double feed occurs during scanning, use the following procedures to clear them.

CAUTION

Be careful when removing jammed paper. Take care not to cut your hand on the edges of the paper.

- 1 Remove any documents that have been left in the eject tray.**

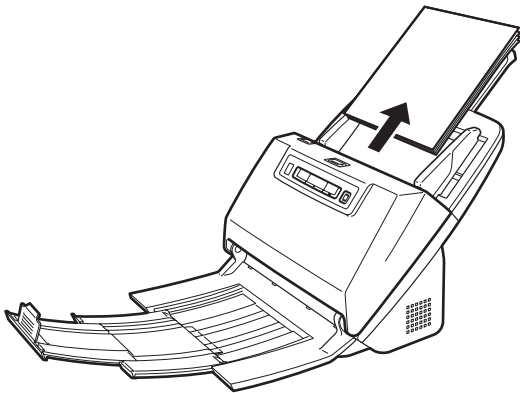

- 2 Pull the OPEN lever and pull open the front unit toward you.**

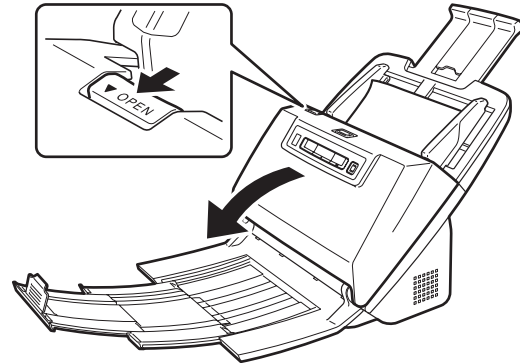

Hint

The "C" error code appears in the operating panel when the front unit is open.

- 3 Remove the jammed document.**

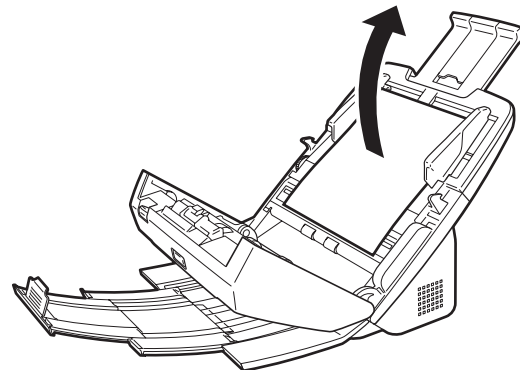

! **IMPORTANT**

Make sure to pull the document out carefully, without applying too much force. If the jammed paper tears while you are pulling it out, make sure to remove any remaining pieces from inside the scanner.

- 4** **Close the front unit by gently pushing it up on both sides until it clicks into place. Make sure that the front unit is completely closed by pushing until you hear a click.**

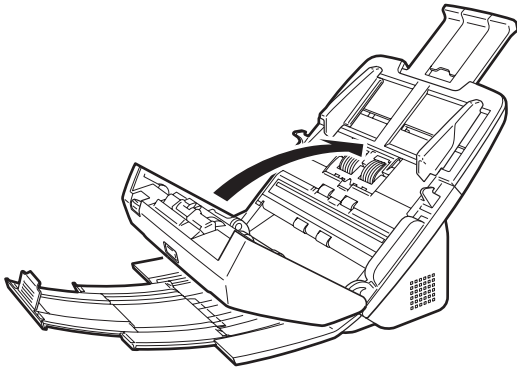

After removing the jammed paper, check to see if the last page was scanned correctly, and then continue scanning.

💡 Hint

When the [Rapid recovery system] check box is enabled in the scanner driver settings screen, you can resume a scanning operation even if it is interrupted by a paper jam by removing the document and resuming from the document that was being fed when the interruption occurred.

As the image of the document that was being fed at the time of the interruption may not be saved in such cases, be sure to verify the last scanned image before resuming the operation.

Uninstalling the Software

If the ISIS/TWAIN driver, CaptureOnTouch or CapturePerfect is not operating normally, follow the procedure below to uninstall them. Then, re-install the software from the Setup disc. (See p. 7)

IMPORTANT

Log on to Windows as an Administrator.

Windows

- 1 From the Windows task bar, click the [Start] button and then [Control Panel].**
- 2 Click [Uninstall a program] ([Add or Remove Programs] in Windows XP).**
The [Uninstall or change a program] dialog box appears.
- 3 From the Programs list, select the software you want to remove and then click [Remove].**
The delete confirmation screen appears.
- 4 Click [Yes].**
Uninstallation of the software is now complete.

Mac

No uninstaller is provided for OS X drivers. To uninstall, use Finder to delete the following files.

/Library/Image Capture/TWAIN Data Sources/DRM160
/Applications/CaptureOnTouch DR-M160

Specifications

Main Unit

Type	Desktop sheetfed scanner	Scanning resolution (Primary Scan Lines x Secondary Scan Lines)	150 x 150dpi/200 x 200dpi/240x240dpi/300 x 300dpi/400 x 400dpi/600 x 600dpi
Scanning Document Size	Plain Paper	Scanning Speed (Conditions: Core i7 2.8GHz CPU, 4 GB memory, A4 document size)	
Size:	Width: 54mm to 216 mm (2.12" to 8.5") Length: 50.8 mm to 356 mm (2" to 14") (You can scan documents up to 3,000 mm (118.1") long by setting the scanner to the Long Document mode.)	Grayscale	Simplex 200dpi 60 pages/min. 300dpi 60 pages/min. Duplex 200dpi 120 images/min. 300dpi 120 images/min.
Paper weight:	Page separation: 27 to 209 g/m ² (7 to 56 lb bond) 0.04 mm to 0.25 mm (0.00157" to 0.00984") Non separation: 27 to 255 g/m ² (7 to 68 lb bond) 0.04 mm to 0.3 mm (0.00157" to 0.0118")	24-bit Color	Simplex 200dpi 60 pages/min. 300dpi 40 pages/min. Duplex 200dpi 120 images/min. 300dpi 100 images/min.
Loading capacity:	A4 size or smaller: 60 sheets (80g/m ² (21 lb bond)) Larger than A4 size: 40 sheets (80g/m ² (21 lb bond)) Make sure stacks do not exceed 10 mm in height (including curls) for either of the above.	Interface	Hi-Speed USB 2.0
Business Card	Size: 50.8 mm x 85 mm (2" x 3.35") or larger Paper thickness: 380 g/m ² (80 lb bond) 0.15 mm (0.0059") or smaller	Other functions	Folio scanning, double feed detection ignore, double feed retry
Orientation:	Vertical feeding only	External Dimensions	280 mm (11.02")(W) x 250 mm (9.84")(D) x 230 mm (9.06")(H) (With the feed tray attached and the document eject tray closed) 280 mm (11.02")(W) x 606 mm (23.86")(D) x 366.4 mm (14.43")(H) (With the feed tray attached and the document eject tray open)
Card	Size: 54 mm x 86 mm (2.12" x 3.37") (ISO standard) Card thickness: 1.4 mm (0.55") or smaller Orientation: Horizontal feeding only Embossed cards can be scanned.	Weight (without AC adapter)	Approximately 3.2 kg (7.05 lb)
Loading capacity:	3 cards (non-embossed), 1 card (embossed)	Power Supply (using AC adapter)	DC24V 1.0A
Scanning Sensor	Contact image sensor	Power Consumption	Scanning: Maximum 27 W In the Sleep mode: Maximum 1.8 W With power switch OFF: Maximum 0.5 W
Light source	LED	Noise	Not more than 63.5 dB
Scanning Side	Simplex/duplex	Operating Environment	Temperature: 10°C to 32.5°C (50°F to 90.5°F) Humidity: 20% to 80% RH
Scanning modes	Black and White, Error Diffusion, 256-level Grayscale, Advanced Text Enhancement, Advanced Text Enhancement II, 24-bit Color		

AC Adapter (100 to 240 V type)

Model Number	MG1-4558
Input	AC100 to 240V, 50/60 Hz, 0.3 to 0.53 A
Output	DC24V 2.0A
Weight	Approximately 0.2kg (0.44 lb) (including power cord)

Specifications are subject to change without notice due to product improvements.

Replacement parts

Exchange roller kit (product code: 9764B001)

Kit to replace the rollers (feed roller, retard roller).

- For the replacement procedure, see [“Replacing Consumable Parts” on p. 85](#).
- Contact your local authorized Canon dealer or service representative for detailed information about the replacement parts.

Option

Barcode module (product code: 1922B001)

2D code module (product code: 1922B003)

Add-on module to recognize barcodes printed on documents during scanning.

Windows Flatbed scanner unit101 (product code: 4101B001)

Flatbed scanner unit that can be connected to and used with a DR scanner. Connecting the unit to this scanner enables you to use this scanner as a flatbed scanner with an automatic document feeder.

Windows Flatbed scanner unit201 (product code: 6240B001)

A flatbed scanner unit that can be used by connecting to a DR scanner and supports A3 size paper.

About the Flatbed Scanner Unit 101/ Flatbed Scanner Unit 201

The optional Flatbed Scanner Unit 101/201 can be connected to and used with this scanner.

System requirements

The computer must comply with the necessary system requirements of Flatbed Scanner Unit 101/201.

The scanner driver of Flatbed Scanner Unit 101/201 needs to be installed to use the unit.

About Use with CaptureOnTouch



Only the Flatbed scanner unit101 can be used with CaptureOnTouch.

About Assigning Function to Start Button

When you connect Flatbed Scanner Unit 101, you can assign Scan First of CaptureOnTouch or any job to the start button of Flatbed Scanner Unit 101.

Limitation of Full Auto Mode

When a document is scanned with Flatbed Scanner Unit 101, Full Auto mode of CaptureOnTouch may not function effectively.

Limitation of Restarting with Start Button

When CaptureOnTouch is set not to be resident in memory, CaptureOnTouch cannot be restarted by pressing the start button on Flatbed Scanner Unit 101 after you end CaptureOnTouch.

About Setting up the Scanner Driver

When functions of this scanner cannot be selected with the Flatbed Scanner Unit 101 settings dialog box, click [Option] in the dialog box to open the scanner driver and make the required settings.

Dimensions

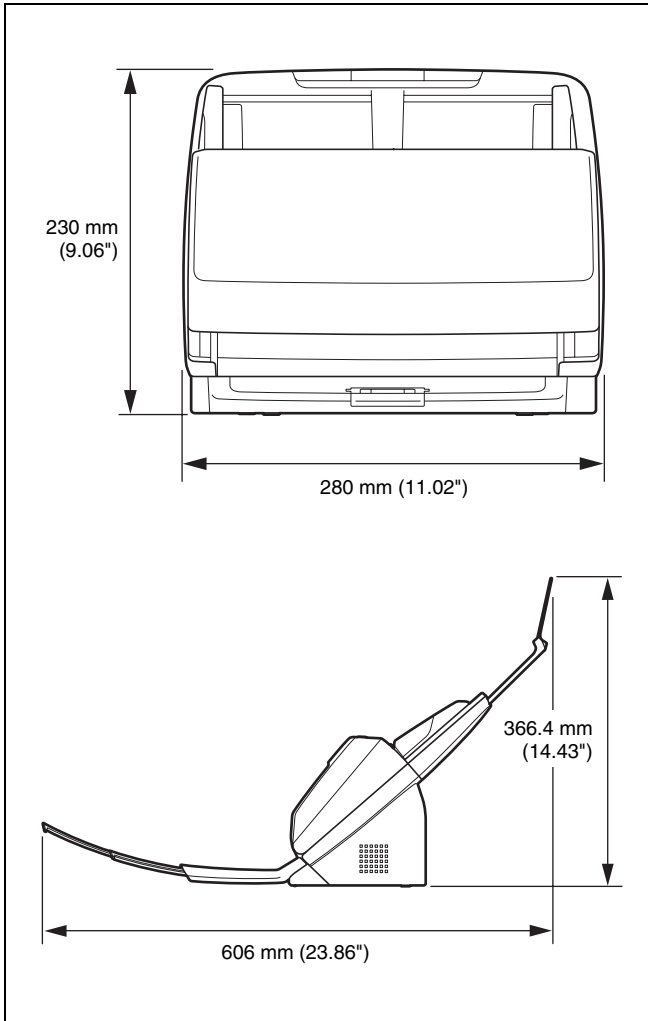

Index

A		
Adjusting the Reduction Ratio	83	
Setting procedure(Windows)	83	
Setting procedure(Mac)	84	
Advanced Mode(Mac)	59	
Auto Power Off Setting(Windows)	90	
B		
Batch Separation(Windows)	70, 77	
C		
CaptureOnTouch		
Environmental Settings	51	
Restarting	40	
Scan First	40	
Select Scan Job	42	
Starting	38	
CapturePerfect(Windows)	55	
Card	29	
Connecting	10	
D		
Detecting	34	
DFR button	22, 36	
Documents		
Card	29	
Folded documents, placing	30	
Loading Documents	25	
Double Feed Detection	34	
Setting procedure(Windows)	34	
Setting procedure(Mac)	35	
F		
Feed Retry	37	
Flatbed scanner unit101	102	
Flatbed scanner unit201	102	
I		
Installing	7	
Third-Party Software	7	
J		
Job		
Editing	42	
Registering	42	
Select and scan	43	
Job No. Indicator	22	
Job Select Button	22	
L		
Long Document Mode	32	
Setting procedure(Windows)	32	
Setting procedure(Mac)	31	
N		
Non separation mode	26	
Setting procedure(Windows)	27	
Setting procedure(Mac)	27	
O		
Operating Panel	22	
P		
Patchcode	77	
Power	11	
R		
Reset		
Counter	88	
Resetting the counter	88	
Setting procedure(Windows)	88	
Setting procedure(Mac)	89	
Rollers		
Cleaning	80	
Replacing	85	

S

Scanner Driver	
Basic Settings	60
Configuring Settings According to Purpose	64
Scanning Glass	
Cleaning	80
Separation Retry	37
Setting procedure(Windows)	37
Setting procedure(Mac)	37
Setup	4
Simple Mode(Mac)	59
Start Button	22
Stop Button	22
System Requirements	6

T

Thin Paper Mode	28
Setting procedure(Windows)	28
Setting procedure(Mac)	28
Third-Party Software	5



CANON ELECTRONICS INC.

3-5-10 SHIBAKOEN, MINATO-KU, TOKYO 105-0011, JAPAN

CANON U.S.A. INC.

ONE CANON PARK, MELVILLE, NY 11747, U.S.A.

CANON CANADA INC.

6390 DIXIE ROAD, MISSISSAUGA, ONTARIO L5T 1P7, CANADA

CANON EUROPA N.V.

BOVENKERKERWEG 59, 1185 XB AMSTELVEEN, THE NETHERLANDS

CANON LATIN AMERICA, INC.

ONE CANON PARK, MELVILLE, NY 11747, U.S.A.

CANON AUSTRALIA PTY. LTD.

1 THOMAS HOLT DRIVE, NORTH RYDE, SYDNEY. N.S.W, 2113. AUSTRALIA

CANON SINGAPORE PTE. LTD.

1 HARBOUR FRONT AVENUE #04-01, KEPPEL BAY TOWER, SINGAPORE 098632

CANON HONGKONG COMPANY LTD.

19TH FLOOR, THE METROPOLIS TOWER, 10 METROPOLIS DRIVE, HUNGHOM, KOWLOON, HONG KONG.

CANON KOREA BUSINESS SOLUTIONS INC.

BS TOWER, 607 TEHERAN-RO, GANGNAM-GU, SEOUL, KOREA

CANON INDIA PVT. LTD

7TH FLOOR, TOWER B DLF CYBER TERRACES DLF PHASE III GURGAON - 122002 HARYANA, INDIA