



# My Cloud™ EX2 Ultra

Private Cloud Storage

User Manual



# WD Service and Support

Should you encounter any problem, please give us an opportunity to address it before returning this product. Most technical support questions can be answered through our knowledge base or email support service at <http://support.wd.com>. If the answer is not available or if you prefer, please contact WD at the best telephone number shown below.

Your product includes 30 days of free telephone support during the warranty period. This 30-day period starts on the date of your first telephone contact with WD Technical Support. Email support is free for the entire warranty period and our extensive knowledge base is available 24/7. To help us keep you informed of new features and services, remember to register your product online at <http://register.wd.com>.

## Accessing Online Support

Visit our product support website at <http://support.wd.com> and choose from these topics:

- **Downloads**—Download drivers, software, and updates for your WD product.
- **Registration**—Register your WD product to get the latest updates and special offers.
- **Warranty & RMA Services**—Get warranty, product replacement (RMA), RMA status, and data recovery information.
- **Knowledge Base**—Search by keyword, phrase, or answer ID.
- **Installation**—Get online installation help for your WD product or software.
- **WD Community**—Share your thoughts and connect with other WD users.
- **Learning Center** — Start here to get the most out of your Private Cloud Storage device (<http://www.wd.com/setup>).

## Contacting WD Technical Support

When contacting WD for support have your WD product serial number, system hardware, and system software versions available.

North America		Asia Pacific	
US & Canada	800 275-4932	Australia	1 800 42 9861
English			
US-Spanish	949 672-7199	China	800 820 6682 / 400 627 6682
Mexico	800.832.4778	Hong Kong	+852-3057 9031
		India	1 800-200 5789 / 1 800-419 5591
<b>Europe (toll free)*</b>	00800 ASK4 WDEU (00800 27549338)	Indonesia	001-803-852 3993
<b>Europe</b>	+31 880062100	Japan	0800-805 7293 / 0120-934 453
<b>Middle East</b>	+31 880062100	Malaysia	1 800-817 477
<b>Africa</b>	+31 880062100	Philippines	1 800-1855 0277 / +63-2-395 2319
<b>Russia</b>	8-10-8002-3355011	Singapore	1 800 608 6008
		Taiwan	0800-225 593 / +886-2-8723 1298
		Thailand	00 1800 852 5913

\* Toll free number is available in the following countries: Austria, Belgium, Denmark, France, Germany, Ireland, Italy, Netherlands, Norway, Spain, Sweden, Switzerland, United Kingdom.

## Registering Your WD Product

Register your WD product to get the latest updates and special offers. You can easily register your drive online at <http://register.wd.com> or by using My Cloud EX2 Ultra Private Cloud Storage software.

# Table of Contents

WD Service and Support . . . . .	ii
Registering Your WD Product . . . . .	ii
<b>1 Important User Information . . . . .</b>	<b>1</b>
Important Safety Instructions . . . . .	1
Recording Your WD Product Information . . . . .	2
<b>2 Product Overview . . . . .</b>	<b>3</b>
About the System . . . . .	3
About the Online Learning Center . . . . .	4
Package Contents . . . . .	5
Pre-installation Instructions . . . . .	6
Handling Precautions . . . . .	6
Product Components . . . . .	7
<b>3 Getting Started . . . . .</b>	<b>9</b>
Installing Drives in the Driveless Model . . . . .	9
Physically Connecting the Device . . . . .	11
Getting Started Using Online Setup Software . . . . .	13
Getting Started Without Online Setup Software . . . . .	19
Accessing Content . . . . .	19
<b>4 Accessing Your Cloud Remotely . . . . .</b>	<b>21</b>
Enabling Cloud Access for the My Cloud EX2 Ultra Device . . . . .	21
Configuring Cloud Access for a User . . . . .	21
Mobilizing Your Files with iOS and Android Mobile Apps . . . . .	23
<b>5 Managing Users, Groups, and Shares . . . . .</b>	<b>34</b>
About Users . . . . .	34
About Groups . . . . .	41
About Shares . . . . .	44
<b>6 The Dashboard at a Glance . . . . .</b>	<b>50</b>
Launching the Dashboard . . . . .	50
The Dashboard Home Page . . . . .	53
Obtaining Customer Support . . . . .	63
Common Tasks . . . . .	65
<b>7 Backing Up and Retrieving Files . . . . .</b>	<b>66</b>
About Backups . . . . .	66
Managing a USB Device and USB Backups . . . . .	66
Remote Backups . . . . .	69
Internal Backups . . . . .	73
Cloud Backups . . . . .	75

<b>8</b>	<b>Managing Storage on My Cloud EX2 Ultra</b> . . . . .	<b>81</b>
	Storage Types . . . . .	81
	RAID Storage . . . . .	82
	Disk Status . . . . .	86
	iSCSI Storage . . . . .	88
	Volume Virtualization . . . . .	92
<b>9</b>	<b>Managing Apps on My Cloud EX2 Ultra</b> . . . . .	<b>97</b>
	About Apps . . . . .	97
	Managing Apps . . . . .	97
<b>10</b>	<b>Playing/Streaming Videos, Photos, &amp; Music</b> . . . . .	<b>101</b>
	Media Servers . . . . .	101
	Media Storage . . . . .	103
	Enabling DLNA and iTunes . . . . .	103
	Accessing Your Private Cloud Using Media Players . . . . .	107
	Accessing Your Private Cloud Using iTunes . . . . .	108
<b>11</b>	<b>Configuring Settings</b> . . . . .	<b>109</b>
	General . . . . .	109
	Network . . . . .	118
	Media . . . . .	125
	Utilities . . . . .	125
	Notifications . . . . .	128
	Firmware Update . . . . .	131
<b>12</b>	<b>Replacing a Drive</b> . . . . .	<b>133</b>
	Identifying a Faulty Hard Drive . . . . .	133
	Replacing a Drive . . . . .	134
	Returning a WD Drive . . . . .	136
<b>13</b>	<b>Regulatory and Warranty Information</b> . . . . .	<b>137</b>
	Regulatory Compliance . . . . .	137
	Warranty Information (All Regions Except Australia/New Zealand) . . . . .	138
	Warranty Information (Australia/New Zealand only) . . . . .	139

<b>Appendices</b> .....	<b>141</b>
Appendix A: My Cloud EX2 Ultra Quick User Guide.....	141
Appendix B: Joomla!® Setup Guide .....	146
Appendix C: phpBB Setup Guide .....	149
Appendix D: Supported RAID Modes .....	154
Appendix E: RAID Migrations .....	154
Appendix F: Safe Mode Firmware Update Procedures .....	154
Appendix G: Technical Specifications.....	156
<b>Index</b> .....	<b>158</b>

## 1

# Important User Information

[Important Safety Instructions](#)  
[Recording Your WD Product Information](#)

## Important Safety Instructions

This device is designed and manufactured to assure personal safety. Improper use can result in electric shock or fire hazard. The safeguards incorporated into this unit will protect you if you observe the following procedures for installation, use, and servicing.

- Follow all warnings and instructions marked on the product.
- Unplug this product from the wall outlet before cleaning. Do not use liquid cleaners or aerosol cleaners. Use a damp cloth for cleaning.
- Do not use this product near any liquids.
- Do not place this product on an unstable surface. The product may fall, causing serious damage to the product.
- Do not drop the product.
- Do not block the slots and openings on the top and bottom of the chassis; to ensure proper ventilation and reliable operation of the product and to protect it from overheating, these openings must not be blocked or covered. Making sure the drive is standing upright also helps prevent overheating.
- Operate this product only from the type of power indicated on the marking label. If you are not sure of the type of power available, consult your dealer or local power company.
- Do not allow anything to rest on the power cord. Do not locate this product where persons will walk on the cord.
- If an extension cord is used with this product, make sure that the total ampere rating of the equipment plugged into the extension cord does not exceed the extension cord ampere rating. Also, make sure that the total rating of all products plugged into the wall outlet does not exceed the fuse rating.
- Never push objects of any kind into this product through the chassis slots as they may touch dangerous voltage points or short out parts that could result in a fire or electric shock.
- Unplug this product from the wall outlet and refer servicing to qualified service personnel under the following conditions:
  - When the power cord or plug is damaged or frayed.
  - If liquid has been spilled on the product.
  - If the product has been exposed to rain or water.
  - If the product does not operate normally when the operating instructions are followed. Adjust only those controls that are covered by the operating instructions since improper adjustment may result in damage and require extensive work by a qualified technician to the product to normal condition.
  - If the product has been dropped or the chassis has been damaged.
  - If the product exhibits a distinct change in performance, contact WD Customer Support at <http://support.wd.com>.

**WARNING!** This device uses a lithium battery, type CR2032. There is danger of an explosion if the battery is incorrectly replaced. Replace only with the same or equivalent battery type recommended by the manufacturer. Dispose of used batteries according to the manufacturer's instructions.

## Recording Your WD Product Information

Remember to write down the following WD product information, which is used for setup and technical support. Your WD product information is found on the label on the back of the device.

- Serial Number
- Model Number
- Purchase Date
- System and Software Notes

## 2

# Product Overview

[About the System](#)  
[Features](#)  
[About the Online Learning Center](#)  
[Package Contents](#)  
[Pre-installation Instructions](#)  
[Handling Precautions](#)  
[Product Components](#)

## About the System

Designed from the ground up with the quality and reliability you've come to expect from WD®, My Cloud EX2 Ultra is a high-performance, two-bay Network Attached Storage (NAS) device for your home or small office. Save all your content in one place and protect your data with RAID 1, cloud, or LAN backup options. Stream large files to any screen and expand your NAS features with a full suite of apps. The My Cloud EX2 Ultra private cloud storage system is a high-performance system providing secure wireless access to your media and files from any computer, tablet, or smartphone when connected to a wireless router.

This user manual provides step-by-step installation instructions and other important information about your WD product. Translated versions and updates to this user manual can be downloaded from <http://products.wd.com/updates>. For more information and news about this product, visit our website at <http://www.wd.com/>.

## Features

**Numerous options** – Choose the diskless enclosure to build your NAS with the drives of your choice. Or, choose a populated system that works right out of the box, featuring WD Red™ hard drives for ultimate reliability in the unique 24x7 NAS operating environment.

**Drive management** – Control your data with multiple drive management options including RAID 0, 1; JBOD, and spanning modes.

**Data protection at its best** – You're armed with multiple options to secure your data from loss. Choose from RAID 1, USB, cloud or LAN/WAN backup depending upon your data security needs.

**Easy to manage** – A powerful dashboard means your system is always under your control. Monitor your drives, manage users and utilize energy-saving features. Email and mobile alerts keep you informed of My Cloud EX2 Ultra status.

**Powerful apps to customize your NAS** – Including aMule, Icecast, Joomla!®, phpBB®, phpMyAdmin, Transmission, SqueezeCenter, and more. For the most recent apps available, visit [www.mycloud.com/learn](http://www.mycloud.com/learn).

**Advanced serving options** – Integrated file server, FTP server, backup server, and P2P torrent download server.

**Stream media to your connected devices** – Stream videos and photos to connected TVs, media players, gaming consoles and other DLNA®/UPnP® devices. Features a Twonky and a DLNA-certified media server. And with a built-in iTunes® server, you can easily stream your music collection.



**Back up, your way** – Protect your data via remote backup to another My Cloud device, integrated cloud backup or local LAN/WAN backup. PC users, WD SmartWare™ Pro offers options for how, when and where you back up your files for up to ten computers. Mac® users, utilize all the features of Apple® Time Machine® backup software to protect your data.

**Expand your capacity** – Simply attach a compatible USB hard drive directly to My Cloud EX2 Ultra to expand your storage capacity. Two USB 3.0 expansion ports are provided. Integrated energy-saving features – Save energy with disk spin-down and scheduled power on/off.

**Your own Private Cloud** – Unlike public clouds, My Cloud EX2 Ultra allows you to keep all your content in one safe place on your home or office network instead of a remote server. No mysterious location of your data. No monthly fees. No limits.

**Advanced features** – iSCSI target, full-featured FTP services, jumbo frame support, IPv6 ready, UPS support (USB and network), real time resource monitor, volume encryption with boot-up password, SNMP and virtual volumes.

## About the Online Learning Center

WD's online Learning Center provides the latest information, instructions, and software to help users get the most out of their Private Cloud Storage. This web-based guide offers step-by-step help with setting up remote access, backing up data, monitoring device status and more. It's an interactive resource to walk users through installing and using their My Cloud EX2 Ultra device. The online Learning Center allows you to:

- Learn about your new Private Cloud Storage product.
- Download the latest software for your product.
- Find in-depth, interactive information on how to explore each of your product's features.
- Update your product whenever new features become available.
- Access an always-available resource online, without a manual or CD.

## Package Contents

- My Cloud EX2 Ultra Private Cloud Storage device
- Ethernet cable
- AC power adapter
- Quick Install Guide
- Assembly kit (for driveless model only)



My Cloud EX2 Ultra Private Cloud Storage Device



AC adapter\*

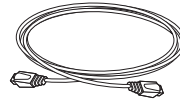

Ethernet cable



Quick Install Guide

For information on additional accessories for this product, visit:

US	<a href="http://www.shopwd.com">www.shopwd.com</a> or <a href="http://www.wdstore.com">www.wdstore.com</a>
Canada	<a href="http://www.shopwd.ca">www.shopwd.ca</a> or <a href="http://www.wdstore.ca">www.wdstore.ca</a>
Europe	<a href="http://www.shopwd.eu">www.shopwd.eu</a> or <a href="http://www.wdstore.eu">www.wdstore.eu</a>
All others	Contact WD Technical Support in your region. For a list of Technical Support contacts, visit <a href="http://support.wd.com">http://support.wd.com</a> and see Knowledge Base Answer ID 1048.

## Operating System

### Windows®

- Windows 10
- Windows 8 or 8.1
- Windows 7
- Windows Vista®

### Mac OS X®

- El Capitan (Mac OS 10.11)
- Yosemite (Mac OS 10.10)
- Maverick (Mac OS 10.9)
- Mountain Lion\* (Mac OS 10.8)
- Lion\* (Mac OS 10.7)

*Note:* Compatibility may vary depending on your computer's hardware configuration and operating system.

## Web Browsers

- Internet Explorer IE10 and above
- Safari 6.0 and later on supported Mac computers
- Firefox 30 and later on supported Windows and Mac computers
- Google Chrome 31 and later on supported Windows and Mac computers

## Local Network

- Router/switch (Gigabit recommended to maximize performance.)

## Internet

- Broadband Internet connection is required for initial setup and software downloads, as well as for remote access and mobile apps.

## Pre-installation Instructions

Before beginning installation, select a suitable location for your device to obtain maximum efficiency. Place it in a location that is:

- Near a grounded power outlet
- Clean and dust free
- On a stable surface free from vibration
- Well ventilated, with nothing blocking or covering the slots and openings on the top and bottom of the device, and away from sources of heat
- Secluded from electromagnetic fields from electrical devices such as air conditioners, radio and television receivers.

## Handling Precautions

WD products are precision instruments and must be handled with care during unpacking and installation. Rough handling, shock, or vibration can damage the device drives. Observe the following precautions when unpacking and installing your external storage product:

- Do not drop or jolt the device.
- Do not move the device while it is powered on.
- Do not use this product as a portable device.
- Do not remove both data drives at the same time. This will cause your device to become unresponsive.



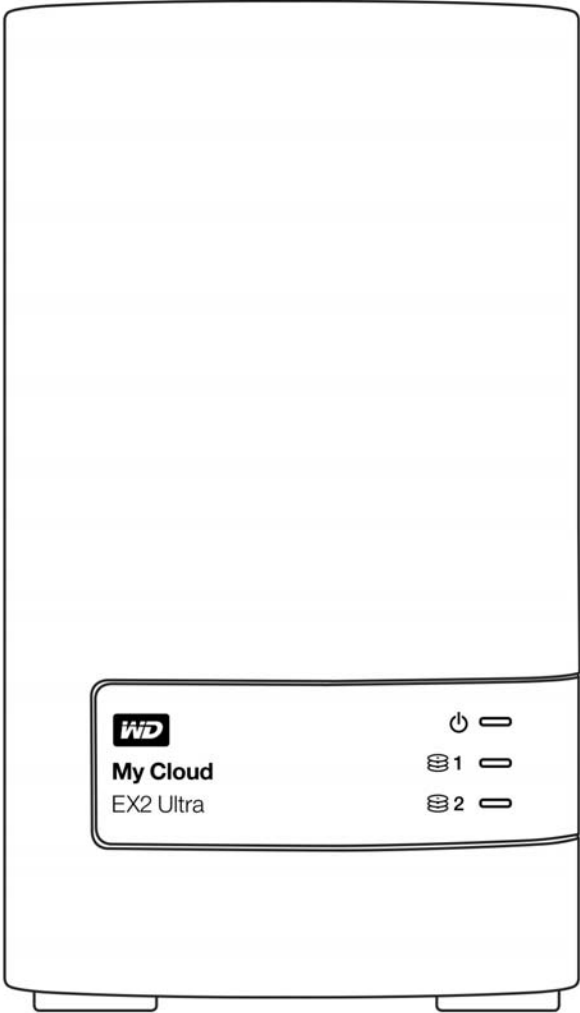

# Product Components

## Front View

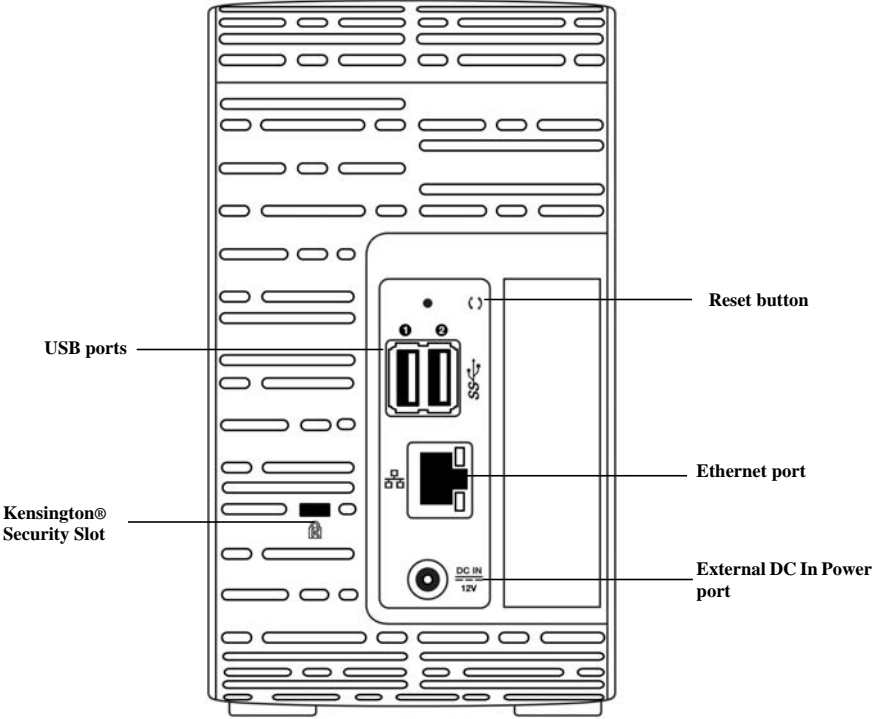

# Back View



Component	Icon	Description
Ethernet port		Connects the device to a local network.
USB 3.0 port		Connects to a USB hard drive for additional storage.
Reset button		Restores settings such as the administrator user name and password for the device.
Power port		Connects the device to an AC adapter and the power outlet.
Kensington security slot		For device security, the device is equipped with a security slot that supports a standard Kensington security cable. Visit <a href="http://www.kensington.com/">http://www.kensington.com/</a> for more information.

## LEDs

### Front Panel Power LED

The following table describes the front panel power LED behavior.

State	Color	Appearance	State Description
Power Down	Black (off)	-----	Drive in standby/sleep mode.
Powering Up	Blue	Flashing	Device is powering on or in the process of updating the firmware.
Power Up	Blue	Solid	Device is in a power up (on) state.
Power Up (degraded)	Red	Flashing	Device is powered up but the volume is degraded.
Action required	Yellow	Flashing	A condition, such as a network cable has become unplugged, which requires you to act.

**Note:** For non-compatible drives, the power LED blinks yellow during power up.

### Front Panel Hard Drive (HDD) LEDs

The following table describes the front panel hard drive LED behavior.

Function	Color	Appearance	Function Description
No drive	Black (off)	-----	Drive is not present.
Drive present, no activity	Blue	Solid	Drive is present but there is no activity.
Active drive	Blue	Flashing	Drive is present and showing drive activity.
Hard drive fault	Red	Flashing	Drive is present but has a hard drive fault or failure.

**Note:** For incompatible drives, the hard drive LEDs blink red rapidly as the unit powers up.

## Back Panel Ethernet (Network) LEDs

The following table describes the network and activity LEDs:

**Note:** Looking at the port, the LED on the top left is the Activity LED, and the one on the top right is the Link LED.

State	LED	Appearance	State Description
Link down	Link	Off	Cable or device is not plugged in, or other end of link is not operational.
Link up – 10/100 connection	Link	Yellow	Cable is plugged in, and both ends of the link have successfully established communications. 10/100 network connection.
Link up – 10/100/1000 connection	Link	Green	Cable is plugged in, and both ends of the link have successfully established communications. 10/100/1000 network connection.
Link idle	Activity	Solid	Active communication is not in progress.
Link busy	Activity	Green - Blinks	Active communication is in progress.

## 3

## Getting Started

[Installing Drives in the Driveless Model](#)

[Physically Connecting the Device](#)

[Getting Started Using Online Setup Software](#)

[Getting Started Without Online Setup Software](#)

[Accessing Content](#)

It's easy to set up the My Cloud EX2 Ultra Private Cloud Storage device -- all you have to do is unpack your device, connect it, and wait for the Power LED on the front of your device to turn a solid blue. Then, download and run the quick setup software, available at <http://www.wd.com/setup>.

**Note:** For information about safely shutting down and disconnecting the device, see "Utilities" on page 92

---

**Important:** To avoid electrostatic discharge (ESD) problems, ground yourself by touching metal before handling the device.

---

### Installing Drives in the Driveless Model

**Important:** Following are instructions for installing drives in My Cloud EX2 Ultra models that come without drives. You may use a drive made by WD or one made by another company. For a list of compatible drives, go to <http://products.wdc.com/>.

---

**Important:** Make sure the device is not connected to power or to the network. To avoid electrostatic discharge (ESD) problems, ground yourself by touching metal before handling the device.

---

**Note:** For further instructions on how to remove and replace a faulty drive, or to prepare and insert a non-WD drive see "[Replacing a Drive](#)" on page 100.



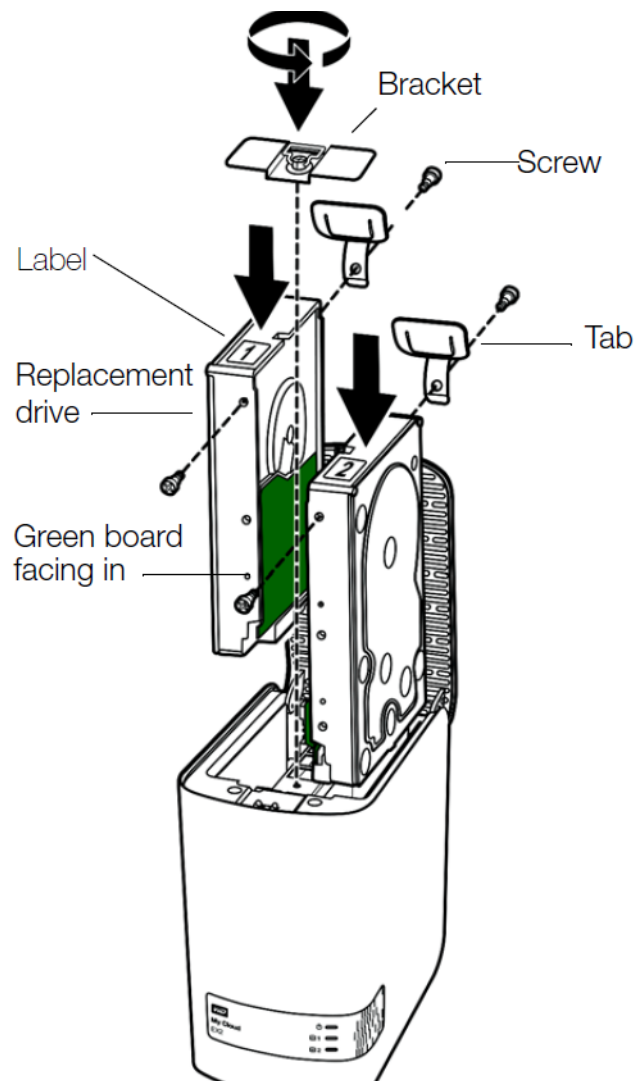

*Note:* You'll need a phillips-head screwdriver for this procedure. Also, the power and network cables are not connected when you do this.

1. Press the indented button on the door (top) of the device and open the top.
2. Remove the bracket that will hold the drives in place.
3. Using a screw from the bag, attach a plastic tab to the top hole in the drive's side (on the right if the green board is facing you).
4. Insert a screw in the corresponding hole on the other side of the drive.
5. Attach labels 1 or 2 to the top of the drive. Label 1 is on the left and label 2 is on the right, when looking down on the top of the unit. There are corresponding numbers on the cross brace label.
6. When looking down on the top of the unit with the front panel towards you, and with the connectors at the bottom of the drive facing in, gently slip the drive into a slot.
7. Make sure the tab is sticking up at the back of the unit.

8. Repeat steps 3-7 for the other drive.
9. Screw the bracket in over the drives.
10. Close the door and firmly push down until it locks into place.
11. Continue to “Physically Connecting the Device” on page 13.

## Physically Connecting the Device

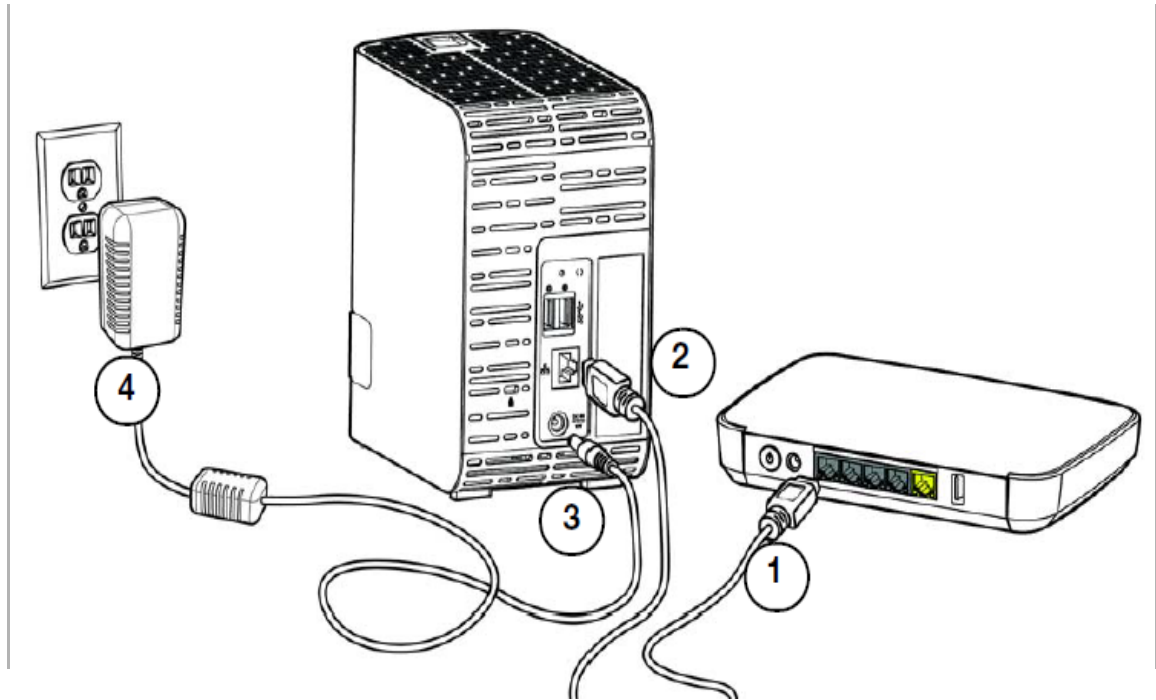

Follow the steps below to connect the My Cloud EX2 Ultra Private Cloud Storage device to a home or small office network.

---

**Important:** To avoid overheating, make sure the device is upright as shown in the illustration above and nothing is blocking or covering the slots and openings on the top and bottom of the device. In the event of overheating, the device will perform a safe shutdown, interrupting all processes currently being performed. If this occurs, data may be lost.

---



---

**Important:** We recommend that you use the enclosed Ethernet cable for best performance.

---

1. Using the provided Ethernet cable, connect one end of the Ethernet cable to the Ethernet port located on the back of the device.
2. Connect the other end of the Ethernet cable directly into a router or network switch port.
3. Connect one end of the power adapter into the power supply socket on the back of the device.

4. Plug the other end of the power adapter into a power outlet. The unit powers up automatically.

---

**Important:** Wait for the My Cloud EX2 Ultra device to finish powering up (approximately three minutes) before configuring it. You will know it is ready when the power LED stops flashing and turns blue.

---

5. When the power LED on your device turns a solid blue, continue to “Getting Started Using Online Setup Software” on page 14.

## Getting Started Using Online Setup Software

The online setup software walks you through the steps necessary to easily connect your device to your home or small office network. Use the following steps to download and run the online setup software, discover the device, and get started using your device. The online setup software is available from WD's Online Learning Center at <http://products.wdc.com/>.

## Downloading and Installing the Online Setup Software

After connecting your device:

1. Open a web browser and type <http://mycloud.com/setup> to display the welcome page.

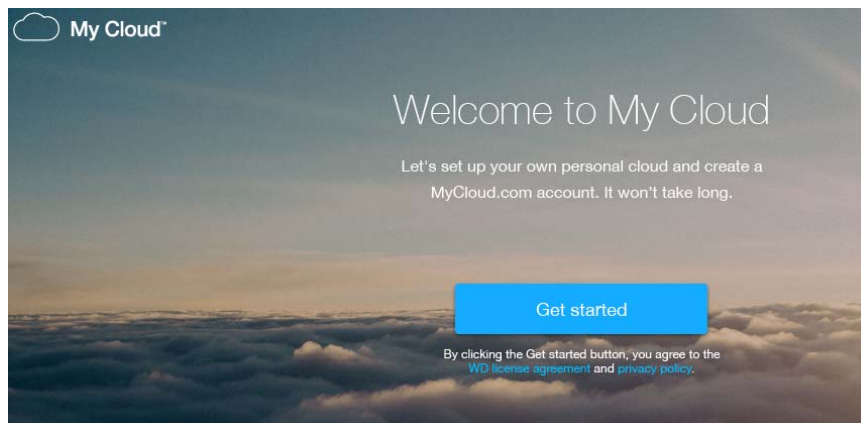

2. On the Welcome page, click **Get Started**.  
The setup software begins searching for your My Cloud device. When your device is found, a screen displays showing your device and IP and MAC addresses.
3. Follow the on screen instructions to complete the setup process and install WD Sync.
4. After setup is complete and WD Sync has been installed, a window displays the most common folders on your computer. Select the folders on your computer that you want to sync with your My Cloud device and click **Next**.
5. WD Sync setup is complete. Click **Close** to exit WD Sync setup.

**Note:** The WD Sync shortcut might be under Show Hidden Icons in your taskbar.

## Getting Started Without Online Setup Software

If you do not use the online setup software to get started, you can still:

- Use your My Cloud EX2 Ultra Private Cloud Storage device as an external hard drive, dragging and dropping files to and from it.
- Configure the device using the My Cloud EX2 Ultra device's dashboard. (See "The Dashboard Home Page" on page 33.)
- Back up files using USB, Remote, Internal, and Cloud backup (see "Backing Up and Retrieving Files" on page 45).

## Accessing Content

The My Cloud EX2 Ultra device's Public folder contains Shared Music, Shared Pictures, and Shared Videos subfolders. The existing content of the subfolders are files that you dragged and dropped or files that have been backed up from your computer or an attached USB drive:

**Note:** This manual uses the term *shares* and *folders* interchangeably.

Once you've physically connected your My Cloud EX2 Ultra device (see "Physically Connecting the Device" on page 13), use the following steps to access the contents of your device.

If your operating systems is...	Then...
Windows 10/ Windows 8 or 8.1	<ol style="list-style-type: none"> <li>1. On the Windows 8 Start page, type <b>Computer</b></li> <li>2. Click <b>Computer</b>.</li> <li>3. In the left pane, click <b>Network</b>.</li> <li>4. Double-click <b>MyCloudEX2Ultra</b> and locate the device's Public folder.</li> <li>5. Double-click the Public folder to display the Shared Music, Shared Pictures, and Shared Videos subfolders. You can now drag and drop files into (and from) the shared media folders using Windows Explorer.</li> </ol>
Windows XP/Vista/Windows 7	<ol style="list-style-type: none"> <li>1. Click  or <b>Start &gt; Computer &gt; Network &gt; MyCloudEX2Ultra</b> and, if required, enter your network (router) credentials. The device's Public and private folders (shares) display.</li> <li>2. Double-click the Public folder to display the Shared Music, Shared Pictures, and Shared Videos subfolders. You can now drag and drop files into (and from) the shared media folders using Windows Explorer.</li> </ol>

If your operating systems is...	Then...
Mac OS X (Snow Leopard, Lion, Mountain Lion, Mavericks)	<ol style="list-style-type: none"> <li>1. In a Finder window, click <b>MyCloudEX2Ultra</b> under the shared items in the side bar.</li> <li>2. If presented with an authorization page, select <b>Guest</b>, and then click <b>Connect</b> to display the Public share:</li> <li>3. Double-click the Public folder to display the subfolders: Shared Music, Shared Pictures, Shared Videos, and Software. You can now drag and drop files into the shared folders using Finder:</li> <li>4. If you want to create a shared drive icon permanently on your desktop, create an alias. Following are two ways to do this: <ul style="list-style-type: none"> <li><b>Note:</b> Before creating an alias, click <b>Finder &gt; Preferences &gt; General</b> and make sure <b>Connected Servers</b> is checked.</li> <li>- Click the item you wish to alias (e.g., Shared Music), hold down the mouse button, hold down the <b>Cmd</b> and <b>Option</b> keys simultaneously, and drag the item to where you want the alias to appear. Instead of moving the original item, this creates an alias at the new location.</li> <li style="text-align: center;">-OR -</li> <li>- Right-click the item you want to alias (e.g., Shared Music), and then click <b>File &gt; Make Alias</b>.</li> </ul> </li> </ol>

## Mapping the Public Folder (Windows)

To map the My Cloud EX2 Ultra Public folder for quick access in the future:

1. In Windows Explorer, under Network, click **MyCloudEX2Ultra**.
2. Right-click the Public folder and select **Map Network Drive** from the menu.
3. Select the desired letter from the **Drive** drop-down list.
4. Select the **Reconnect at login** check box.
5. Click **Finish**. Your Public drive is now mapped.

## 4

# Accessing Your Cloud Remotely

- Enabling Cloud Access for the My Cloud EX2 Ultra Device
- Configuring Cloud Access for a User
- Mobilizing Your Files with iOS and Android Mobile Apps

A private cloud is your content, at home, secure and under your control. Unlike public clouds, a private cloud allows you to keep all of your content in one safe place on your home network. Share files, stream media, and access your content anywhere, from your PC or Mac computer and from mobile devices. No monthly fees. No mysterious location for your data. Keep your videos, music, photos, and files safe at home and always with you.

This chapter explains how to set up the My Cloud EX2 Ultra device for remote access and describes some of the ways you can take advantage of its many capabilities.

## Enabling Cloud Access for the My Cloud EX2 Ultra Device

Before you can use your My Cloud EX2 Ultra device remotely, you have to enable it for cloud access. To enable the My Cloud device for remote access and to check the status of its remote connection(s), see “Cloud Access” on page 81.

## Configuring Cloud Access for a User

Once you’ve enabled cloud access on the My Cloud EX2 Ultra device, use the following steps to give remote access capability to your device users.

1. On the navigation bar, click the **Cloud Access** icon .

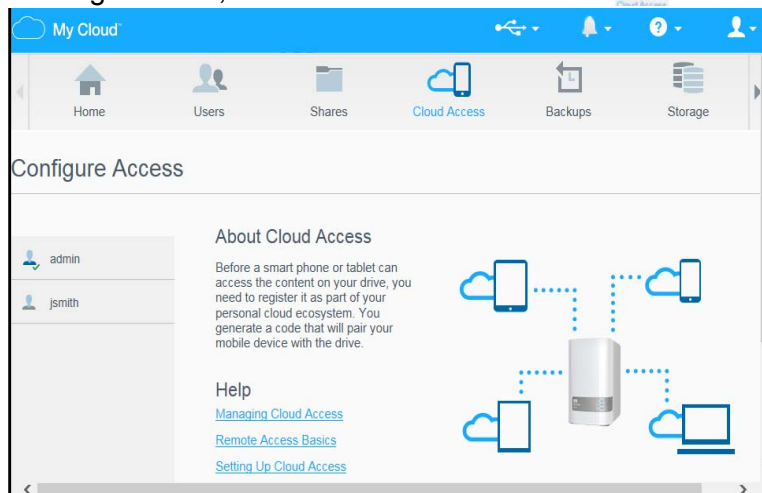

2. In the left pane, select the user you’d like to configure for cloud access.
3. In the MyCloud.com Login for <user name> area, click the **Add/ Change Email Address** icon . Click this icon if you have not previously added an email address to the user account or if you need to update/change the user’s email address.
4. Enter the user’s email address. This email address is used to send the user confirmation information and instructions on setting up and activating a password for cloud access.
5. Click **Save**.

6. If you have entered an email address, this icon is greyed out. Add an email address, and then return to this link to send cloud access information.

### **To generate an activation code for a user's mobile device(s):**

---

**Important:** Codes are valid for 48 hours from the time of the request and can be used only once.

---

1. On the bottom of the screen, click **Get Code**. You'll need to generate one code for each device you want to activate. A dialog box displays the user's activation code and its expiration date and time.  
  
*Note:* Make sure to write down the access codes you generate.
2. Click **OK**. Once you use the code(s), the Configure Access page displays the cloud devices to which the user now has access, along with the activation code used.

## Mobilizing Your Files with iOS and Android Mobile Apps

The My Cloud mobile app and My Cloud desktop app allow you to access all the content on your Private Cloud from any device.

### My Cloud Mobile App

You are always connected to your private cloud. Save valuable space on your mobile devices with easy photo and video uploads directly to your private cloud, then securely access and share your memories.

The My Cloud mobile app also allows you to easily transfer files between your private cloud, Dropbox™ and other public cloud accounts.

With My Cloud mobile app, you can:

- Open and view the important files stored on your My Cloud EX2 Ultra device from anywhere without copying them to your mobile device.
- Show off the photos stored on your My Cloud EX2 Ultra device.
- Connect to other cloud sites such as Dropbox from your tablet or smartphone.
- Stream and enjoy music and video files stored on your My Cloud EX2 Ultra device.

*Note:* Video streaming performance is best over your LAN and when your mobile device is connected using Wi-Fi wireless connections. WAN streaming performance may be limited by upload speeds on your home Internet connection.

- Share your presentations on your Apple or Android tablets. Your My Cloud app supports most major file types, such as Microsoft Word documents, Microsoft Excel spreadsheets, and PowerPoint presentations.

For more features and instructions, see the Help, Guide Me page, and Quick Tips within the WD Photos app, or go to <http://mycloud.wd.com>.

*Note:* My Cloud app brings your data from the My Cloud EX2 Ultra device to your tablet, handset, or other portable devices using Google Android or Apple iOS. My Cloud provides a convenient file list of the My Cloud EX2 Ultra device contents and then launches your favorite player or viewer for any files you wish to open. For file types your mobile device supports, see the device's manual.

### Requirements

- My Cloud EX2 Ultra cloud storage with the most recent firmware, connected to the Internet.
- Access to cloud services requires the My Cloud Mobile app and an active Dropbox, Google Drive, or OneDrive™ account.
- iOS iPhone or iPad running versions 7.0 or later software.
- Android smartphone or tablet running versions 4.0 or later software.

### Installing the My Cloud Mobile App

Download the My Cloud mobile app from the Apple App or Google Play store and install it on your mobile device.



## 5

# Managing Users, Groups, and Shares

[About Users](#)  
[About Groups](#)  
[About Shares](#)

## About Users

The Administrator, normally the device owner, is the person in charge of setting up the device. As the My Cloud EX2 Ultra device owner, you have a special user account (admin) that provides you with administrator privileges. With these privileges, you can set up and configure the device to your specific needs and add other users to your private cloud. You also have the power to determine exactly what users can access on the device.

As a default, the administrator (admin) user name does not have a password. You can create one at anytime (see “Updating a User Password” on page 24).

*Note:* Only one individual at a time can use the Administrator logon ID to log into the web browser app. Because of this, ensure that you log out of the My Cloud EX2 Ultra device web browser app when you’re not using it. This allows other users authorized to use the Administrator logon ID to access the web browser app.

See Energy Saver - Web Access Timeout on “Energy Saver” on page 83 to automatically log out of the app after a set amount of time.

The Users screen displays a list of the current users and allows the Administrator to view user details, create new users, create groups, and grant a user access to existing shares and groups.



## Viewing Users

1. On the navigation bar, click **Users** to display the Set Up Users screen.
2. To view user details, click a user name on the left pane. The user’s profile and share access information display. A user can have read only, read/write, or no access to a share.

*Note:* The shares in the Share Access section are not editable because they are public shares. Once you make a share private, the share displays in the list and you can edit it. (See “Making a Share Private” on page 30.)

## Adding a Single User

The Administrator adds user accounts and sets the parameters of the shares that a user can access. Use the following steps to add a single user account.

1. To add a user, click  in the lower left side of the screen.
2. Enter the User Name, First Name, Last Name and Email address (optional) of the user you’d like to add in the applicable fields, and then click **Next**.
3. To assign a password, click the toggle button  to ON, enter a password, and then confirm the user’s password. Click **Next**.
4. To assign a group to the new user, click the check box next to a group, and then click **Next**.

5. Enter the Quota Amount, or leave the values blank for unlimited space, and then click **Apply**. (See “Quota Rules” on page 24 for information on quotas.) Your new user account displays on the left pane of the Set Up Users screen.

## Adding Multiple Users

Use the following steps to add multiple user accounts.

1. To add multiple users, click **Add Multiple Users** in the lower left side of the screen.

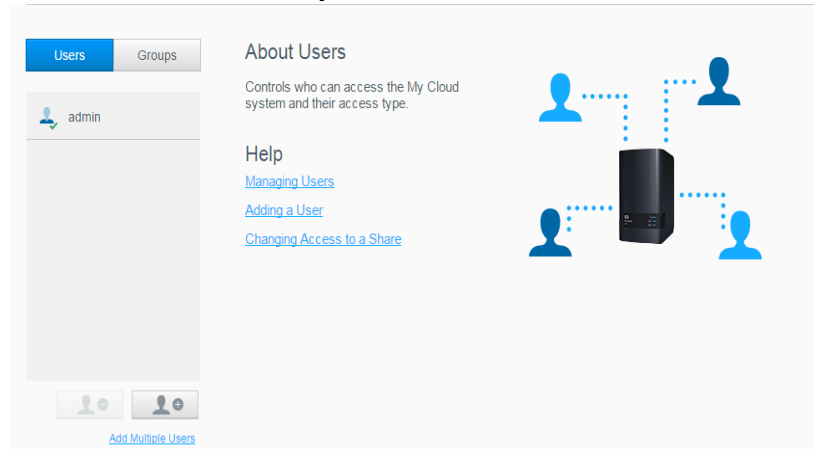

2. Select how you'd like to enter your users into the device, and then click **Next**.
  - **Create Multiple Users:** Allows you to enter users manually. See “**Create Multiple Users**” on page 22
  - **Import Users:** Allows you to import a list of users into the device. Continue to “**Import Multiple Users**” on page 23.

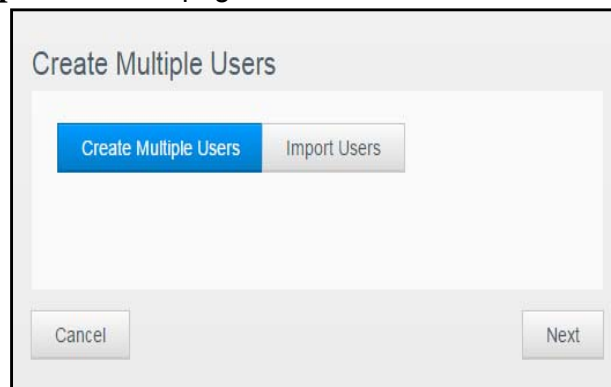

### Create Multiple Users

1. Enter the following information on the Create Multiple Users screen, and then click **Next**:
  - **Username Prefix:** Enter a prefix for your user name. This will be added to the Account Prefix to create the User Name. (Example: HR)
  - **Account Prefix:** Enter a numeric account prefix. This will be added to the Username Prefix to create the User Name (Example: 143)
  - **Number of Users:** Enter the number of User accounts you'd like to create. The maximum number you can add displays to the right.
  - **Password:** Enter a password for the user accounts.
  - **Confirm Password:** Confirm the password for the user accounts.

- **Overwrite Duplicate Accounts** (optional): Select this check box to overwrite any existing duplicate accounts on your device.

2. To assign a group to the new users, click the check box next to a group, and then click **Next**.

3. Enter the Quota Amount, or leave the values blank for unlimited space, and then click **Next**. (See “Quota Rules” on page 24 for information about quotas.)
4. Your new user accounts display on screen. Click **Apply** to save them to your device.

### Import Multiple Users

1. Click **Download** to download a.txt file identifying the format you’ll need to set up your user import file.
2. Create and save your import file. Your import file should be formatted as follows:
  - **User import file format:** #user name/user password/user groups/ shared folder(rw)/ shared folder(ro)/ shared folder(deny)/user quota
  - **Example:** #user/pw/g1:g2/folder1:folder2/folder3:folder4/folder5:folder6/0:0:0:0
3. Click **Import User List** and select the import file you created.
4. Click **Next**.
5. Select the apps you’d like the new user accounts to have access to and click **Next**.
6. Click **Apply**. Your new user accounts save to your device.

### Editing User Settings

1. On the Set Up Users screen, select the user whose information you’d like to edit. The User Profile and Share Access panels display.
2. Modify the required and optional settings as desired.
3. If a private share has been created on the Share screen, it displays in the Share Access panel of the Set Up Users screen. You can assign an access level to it for

each user. (See “Making a Share Private” on page 30 for information on creating a private share.)

## Updating a User Password

When viewing details about a user, the Administrator can add or change the user’s password (no password is the default setting). Use the following steps to update a user password.

1. On the Set Up Users screen, select a user from the list on the left.
2. Click the toggle button  if no password has been previously created.
3. Click **Configure** to the right of the toggle button  to display the Edit Password screen:
4. Enter the new password in both the Password and Confirm Password fields.
5. Click **Apply**.

## Assigning a User to a Group

Use the following steps to assign a user account to a user group.

1. On the Set Up Users screen, select the user from the left pane.
2. In the **Group Membership** field, click **Configure**.
3. Select the check box next to the Group you’d like the user to join, and then click **Apply**.

## Quota Rules

Assigning user quotas allows you to better control the disk space allocated to a user or a group. There are various rules dictating which quota takes precedent over another.

- User quota must be  $\leq$  the group quota (e.g., if your group has a 20GB quota and you try to set the user quota to 30GB quota, you will be prompted to reduce your user quota to be equal to or less then the group quota).
- If the user quota is not set, the group quota is assigned to the user.
- When a user quota is set prior to joining a group and a group is assigned:
  - If the user quota  $>$  group quota, the individual user ‘s quota is automatically reduced to the group quota amount.
  - If the user quota is  $\leq$  group quota, the individual user quota remains unchanged.

## Assigning Quotas to a User

Use the following steps to assign a quota to a user account. A quota determines the amount of disk space allocated to the user on the My Cloud EX2 Ultra device.

1. On the Set Up Users screen, select the user from the left pane.

2. In the Quotas field, click **Configure**.

3. Enter the amount of space to assign to the user on the My Cloud EX2 Ultra device.
  - To assign unlimited space, leave the Quota Amount field(s) blank.
4. Click **Apply**.

## Removing a User

Use the following steps to delete users from the My Cloud EX2 Ultra device.

*Note:* The Administrator account cannot be deleted.

1. On the Set Up Users screen, in the left pane, select the user you'd like to delete.
2. Click the **Remove User** icon .
3. In response to the confirmation message, click **OK**. The user account is removed from the device and no longer displays in the user account list.

## About Groups

A group allows easier management of multiple users. The permissions and privileges you assign to group accounts determine the actions that can be taken by that group.

## Viewing Groups

1. On the navigation bar, click **Users** to display the Set up User screen.
2. Click the **Group** tab below Set Up Users.
3. To view group details, click a group name on the left pane. The group profile information displays.

## Adding a Group

1. To add a group, click  in the lower left side of the Set Up Groups screen.
2. Enter a Group Name.
3. Click the check box next to the users you'd like to add to your new Group and click **Next**.
4. Enter the Quota Amount, or leave the values blank for unlimited space, and then click **Apply**. Your new group account displays on the left pane of the Set Up Groups screen.

## Editing Group Settings

1. On the Set Up Groups screen, select the Group whose information you'd like to edit. The Group Profile and Share Access panel displays.
2. Modify the required and optional settings as desired. To update the group's access to shares, see "Assigning Share Access to Groups" on page 26

## Assigning Share Access to Groups

Once a group account is created, you can assign access to the various shares on your My Cloud EX2 Ultra device using the following steps.

1. On the Set Up Groups screen, select the group for which you'd like to assign a share.
2. In the Share Access area, select the type of access you'd like to assign to the selected user:
  - **Read/Write Access:** Select this option to provide the group account with read/write access to the selected share. The group members can view and update the share.
  - **Read Only Access:** Select this option to provide the group account with read only access to the selected share. The group member can view the share but can't update it.
  - **Deny Access:** The group has no access to this share.

The group is updated with your share access selection.

## Assigning Quotas to a Group

Use the following steps to assign a quota to a Group. A quota determines the amount of space assigned to the user on the My Cloud EX2 Ultra device. (See “Quota Rules” on page 24 for information on quotas.)

1. On the Set Up Groups screen, select the group from the left pane.
2. In the Quotas field, click **Configure**.
3. Enter the amount of space you'd like to assign to the group on the My Cloud EX2 Ultra device. To assign unlimited space, leave the Quota Amount field(s) blank.
4. Click **Apply**.

## Removing a Group

Use the following steps to delete users from the My Cloud EX2 Ultra device.

1. On the Set Up Group screen, select the user you'd like to delete in the left pane.
2. Click the **Remove Group** icon .
3. In response to the confirmation message, click **OK**. The Group account is removed from the device and no longer displays in the Group account list.

## About Shares



A share is an area on the My Cloud EX2 Ultra device for storing files (similar to a folder or directory).

**Note:** In this manual, we use the terms share and folder interchangeably.

A share can be public so that all users can access the contents, or private to limit access to selected users. The **Shares** icon on the navigation bar displays a list of shares on the My Cloud EX2 Ultra device and enables the Administrator to manage shares and user access.

**Note:** USB flash drives can be mounted as a share, however, they are not editable.

## Viewing a List of Shares

Click the **Shares** icon on the navigation bar to display a list of shares on the My Cloud EX2 Ultra device. For each share name, the description, media serving, and public access status display.





Use the following steps to view a list of shares.

1. On the navigation bar, click **Shares** to display the About Shares page.



2. Click a share to display its profile and share access information.



### Share Profile

Volume	Volume_1
Share Name	<input type="text" value="new"/>
Share Description	<input type="text"/>
Public	<input checked="" type="checkbox"/> ON <input type="checkbox"/>     
Recycle Bin	<input type="checkbox"/>     <input type="checkbox"/> OFF 
Media Serving	<input type="checkbox"/>     <input type="checkbox"/> OFF 
Oplocks	<input checked="" type="checkbox"/> ON <input type="checkbox"/>     
Usage	4.0K

**Note:** Only private shares can be edited. Public shares always have read/write access and are therefore grayed out.

## Creating a New Share

You can create a share and designate it as public or private. For example, if the share contains financial information, you may want to make the share private. Or, if there are photos you would like a friend to see, you can make the share public to that friend.

1. Click the **Shares** icon  on the navigation bar to display the About Shares screen.
2. Click the **Add a Share** icon .
3. Complete the following settings:

Volume	Select the volume from the drop-down menu.
Share Name	Assign a name to the share. (Names must be case sensitive, and contain 1-32 alphanumeric characters but no spaces.)
Share Description (optional)	Enter a brief description of the share to remind yourself of what it contains. Note that share descriptions must begin with an alphanumeric value and can contain up to 256 characters.
Enable Recycle Bin (optional)	The Recycle Bin contains any files deleted from the My Cloud EX2 Ultra device. If you'd like to use the Recycle Bin, click the toggle button  to ON. (Default is OFF.)

*Note:* The Recycle Bin is only available for Windows SMB files.

4. Click **Next**.
5. Complete the following settings:

Enable Media Serving (optional)	This option allows you to stream media stored in this share to other devices. If you'd like to Enable Media Serving, click the toggle button  . The default is OFF.
---------------------------------	--

*Note:* The media server must be enabled for the device before you can provide media serving for a share.

See "Enabling DLNA" on page 72 for instructions on enabling media serving for the device.

FTP Access (optional)	This option allows FTP access on this share. If you'd like to use FTP Access, click the toggle button  .
-----------------------	---

*Note:* FTP access must be enabled before you can provide FTP access for a share. See "Network Services" on page 86 for instructions on how to enable FTP access.

WebDAV Access (Optional)	This option allows WebDAV access on this share. If you'd like to use WebDAV Access, click the toggle button  .
--------------------------	---



*Note:* WebDAV access must be enabled before you can provide FTP access for a share. See "Network Services" on page 86 for instructions on how to enable WebDAV access.

## Editing Share Settings

1. On the Set Up Shares screen, select the share you'd like to edit. The Share Profile panel displays.
2. Modify the required and optional settings as desired.

## Making a Share Private

If you decide there is a reason to limit access to a public share, convert it to a private share.

1. On the Set Up Shares screen, select the share:
2. Switch the **Public Access** button to OFF.
3. For each user listed in the **User Access** section, select the level of access by clicking the appropriate icon for the share (read/write , read only , or no access ).

## Deleting a Share

**WARNING!** Deleting a share erases all files and folders on the share.



1. Select the share in the list of shares on the About Shares page.
2. Click the **Delete Share** icon .
3. In response to the confirmation message, click **OK**.

## Accessing the Contents of a Share Locally

**Note:** For information on accessing the contents of a share remotely, see “Accessing Your Cloud Remotely” on page 17.

Several options are available for opening a My Cloud EX2 Ultra share. For a private share, the user must have:

- A user name and password assigned to the share name
- Read-only or full access to the share

IF you want to open a share using . . .	THEN . . .
Windows 10/ Windows 8 or 8.1	<ol style="list-style-type: none"> <li>1. In the task bar, click the <b>File Explorer</b> icon .</li> <li>2. In the left panel, select <b>Network</b>, and double-click <b>MyCloudEX2Ultra</b>.</li> <li>3. Double-click a Public or private share on your device.</li> </ol>
Windows Vista/Windows 7/ Windows XP	<ol style="list-style-type: none"> <li>1. Click  or <b>Start &gt; Computer</b>.</li> <li>2. In the left panel, select <b>Network</b></li> <li>3. Click <b>MyCloudEX2Ultra</b>.</li> <li>4. Double-click the Public or private shares on your device.</li> </ol>
Mac OS X	<ol style="list-style-type: none"> <li>1. Open a Finder window and locate your My Cloud device under the Shared heading in the side bar. If presented with an authorization page, select Guest and then click <b>Connect</b>.</li> <li>2. Click the device to display the Public share and any private shares to which you have access.</li> </ol>

## 6



# The Dashboard at a Glance



[Launching the Dashboard](#)  
[The Dashboard Home Page](#)  
[Obtaining Customer Support](#)  
[Common Tasks](#)

Use the My Cloud EX2 Ultra dashboard to configure settings and to manage the device as you prefer. For example, you can set up user accounts and restrict access to the files on your My Cloud EX2 Ultra device, set up folders for storing files, enable remote access, and customize the device to suit your needs.

## Launching the Dashboard

Use one of the following methods to launch the dashboard:

IF you want to launch from . . .	THEN . . .
Desktop Icon	 Double-click the dashboard icon to launch the My Cloud EX2 Ultra dashboard.
A browser or Windows Explorer	<p><b>Using Device Name:</b></p> <ol style="list-style-type: none"> <li>Enter the name of your My Cloud EX2 Ultra device (default name: MycloudEX2Ultra) in the browser's address field:             <ul style="list-style-type: none"> <li>- <b>http://&lt;device name&gt;</b> (Windows) (Example: http://MyCloudEX2Ultra)</li> <li>- <b>https://&lt;device name&gt;.local</b> (Mac) (Example: https://MyCloudEX2Ultra.local)</li> </ul> </li> <li>Click <b>Go</b>.</li> </ol> <p><b>Using IP Address:</b></p> <ol style="list-style-type: none"> <li>Enter the IP address of your My Cloud EX2 Ultra device in the browser's address field: <b>http://&lt;IP Address&gt;</b> You can find the IP address from your router's UI. (Example: http://192.168.1.22)</li> <li>Click <b>Go</b>.</li> </ol>
Windows 10/ Windows 8 or 8.1	<ol style="list-style-type: none"> <li>On the Start page, type <b>Computer</b>.</li> <li>Click <b>Computer</b>.</li> <li>In the left pane, click <b>Network</b>.</li> <li>In the right panel, locate your My Cloud EX2 Ultra device under Storage.</li> <li>Double-click the device, or right-click and select <b>View device webpage</b> from the resulting menu.</li> </ol>
Windows 7/Vista	<ol style="list-style-type: none"> <li>Click  &gt; <b>Computer</b>.</li> <li>In the left panel, select <b>Network</b></li> <li>In the right panel, locate your My Cloud EX2 Ultra device under Storage.</li> <li>Double-click the device, or right-click and select <b>View device webpage</b> from the resulting menu.</li> </ol>
Windows XP	<ol style="list-style-type: none"> <li>Click <b>Start &gt; My Network Places</b>.</li> <li>Locate your My Cloud device.</li> <li>Double-click the device or right-click and select <b>Invoke</b>.</li> </ol>

IF you want to launch from . . .	THEN . . .
Mac OS X	<ol style="list-style-type: none"> <li>1. Click the Safari icon  &gt; <b>bookmark icon</b>  &gt; <b>Bonjour</b>.</li> <li>2. Double-click the My Cloud EX2 Ultra device on the network.</li> </ol>
Mobile Devices	<p><b>iOS Devices:</b></p> <ol style="list-style-type: none"> <li>1. Open a browser.</li> <li>2. In the Address bar, enter https://&lt;device name&gt;.local.</li> </ol> <p><b>Android Devices:</b></p> <ol style="list-style-type: none"> <li>1. Open a browser.</li> <li>2. In the Address bar, enter http://&lt;device name&gt;.</li> </ol>

## Accessing the Dashboard for the First Time

Use the following steps when you initially access the My Cloud EX2 Ultra dashboard.

1. When you initially log into My Cloud EX2 Ultra, leave the Password field blank.
2. Click **Login**. Select a language from the drop-down menu.

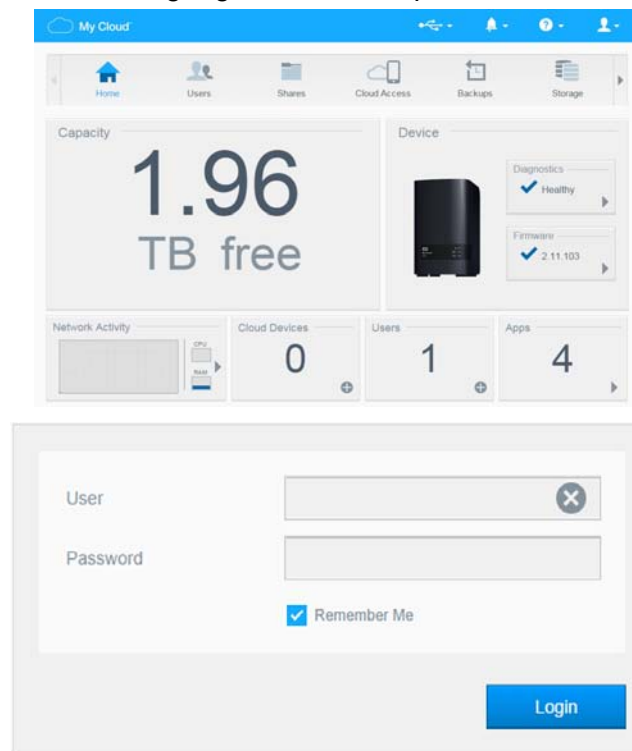

3. Click the **WD End User License Agreement** link, review the agreement, and then click **the I agree to the WD End User License Agreement** check box.
4. Click **Continue**.
5. Enter your First Name, Last Name, and Email address (optional) to create an admin login for your My Cloud EX2 Ultra device, and then click **Save**.
6. If you'd like to add additional users, enter the User Name, First Name, Last Name, and Email address (optional) of the additional users, and then click **Save** for all additional users. To create a remote access account, you must enter the user's email address.
7. Click **Next**.



8. Review the information on the screen.  
If desired:
  - Click the **Automatically update device firmware when available** check box.
  - Click the **Register the My Cloud EX2 Ultra device to receive continuous product support** check box.
9. Click **Finish**. The My Cloud EX2 Ultra dashboard displays.

## The Dashboard Home Page

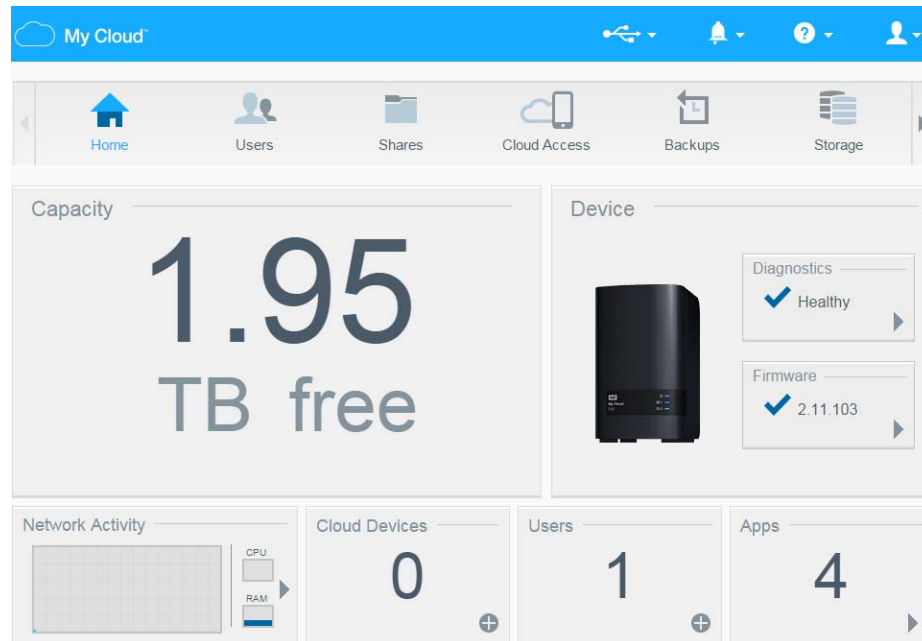





The My Cloud EX2 Ultra Home page has an information bar at the top right, an navigation icon bar across the page, and an instant overview of the status of the device's main functions with links for updating settings.



## Information Icons

Icon	Name	Actions
	USB device on the My Cloud	Click to display the number of USB devices connected (a hub with multiple devices can be connected to the USB port). Icon is dim if no USB is attached.
	Alerts	Click to display recent alerts about new firmware and network issues.
	Critical alerts	Click to display a severe warning: over temperature, under temperature, drive SMART failure, failure of the data volume to mount.

## Navigation Icons

Icon	Name	Actions
	Home	The dashboard displays an instant overview of the status of the device's main functions and links for updating settings.
	Users	Create, change, and delete users and grant them full or limited access to particular shares.
	Shares	Create, change, and delete shares (folders) and grant specific users full, limited, or no access to particular shares.
	Cloud Access	Set up, change, and remove remote cloud access to particular shares. Monitor remote access status.
	Backups	Create backups to: <ul style="list-style-type: none"> <li>• A USB drive</li> <li>• Another My Cloud EX2 Ultra on your local network or on a remote network</li> <li>• Another location on your My Cloud EX2 Ultra device</li> <li>• A Cloud backup site</li> </ul>
	Storage	Select the way your My Cloud EX2 Ultra device stores your data.
	Apps	Add or remove various apps that allow you to use your device more productively.

Icon	Name	Actions
	Settings	Configure advanced settings for your My Cloud EX2 Ultra device, including: <ul style="list-style-type: none"> <li>• General device settings,</li> <li>• Network configurations</li> <li>• ISO mount options</li> <li>• Media options,</li> <li>• Device utility tasks</li> <li>• Notification settings</li> <li>• Firmware update setting</li> </ul>

## Viewing Device Status and Making Updates on the Home Page

The main body of the Home page shows the status of the device and its functions and provides shortcuts to the most necessary tasks.

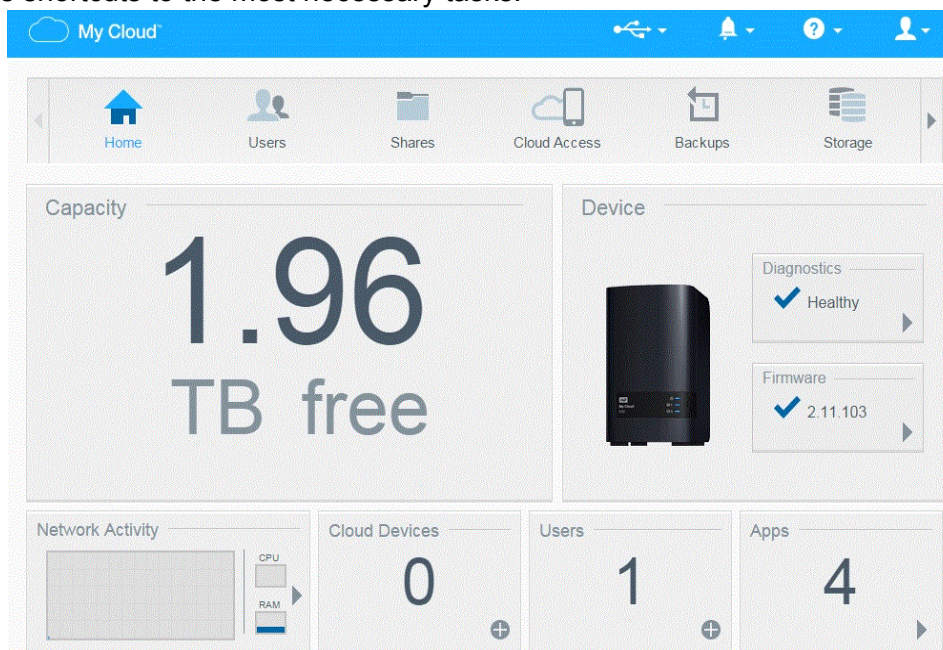

### Capacity

The Capacity panel displays the amount of free storage left on your My Cloud EX2 Ultra device.





1. To see detailed information, click the arrow in the lower right to display the current usage of the drive's capacity:

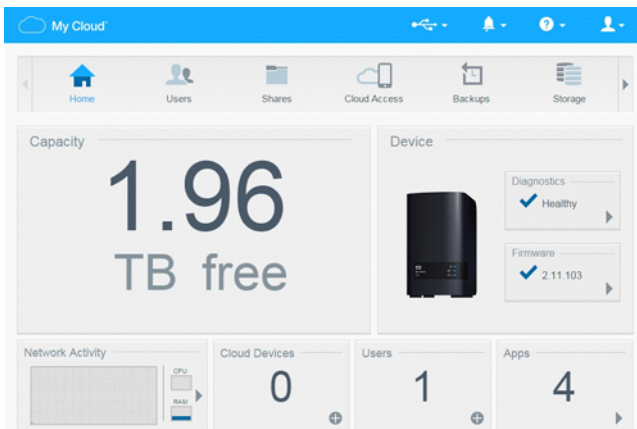

2. To return to the Home page, click **Close**.

### Device

The Device section identifies the overall health of the system, indicates the current version of your firmware, and informs you if firmware updates are available.

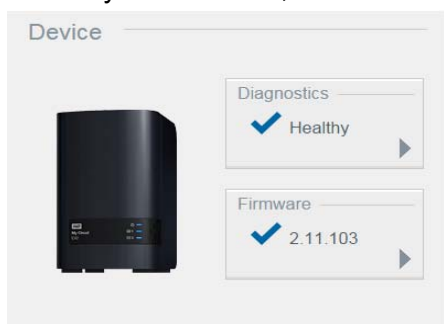

### Diagnostics

The Diagnostics section displays a snapshot of the system's components and identifies the overall health of the My Cloud EX2 Ultra device.

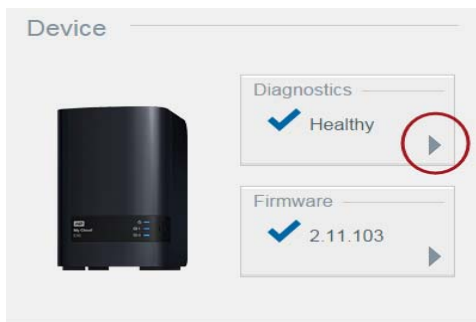

1. To see details about the status of system components, click the arrow on the right side of the panel.



2. To return to the Home page, click **Close**.

### Firmware

The Firmware section displays the current version of firmware loaded on your My Cloud EX2 Ultra device. A blue check mark indicates that your firmware is up-to-date.

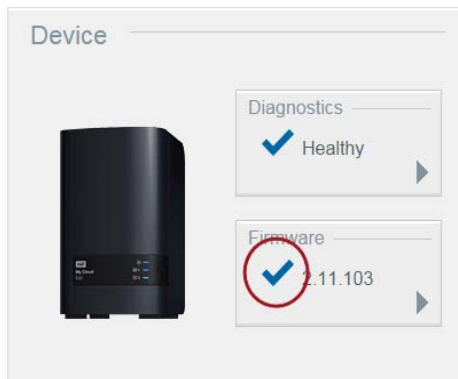

1. To view whether an updated version of the firmware is available, click the arrow to the right of Firmware to display firmware availability:

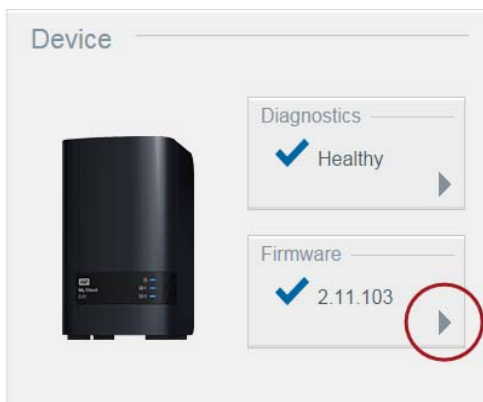

- If an update is available, click **Install and Reboot** to update your device.
2. To return to the Home page, click **OK** or **Cancel**.

*Note:* If new firmware is available, see “Firmware Update” on page 98 for information on updating your My Cloud EX2 Ultra device.

## Network Activity

The Network Activity panel displays the system activities and processes that are running on your My Cloud EX2 Ultra device. At a glance, you can see the network, CPU, and RAM activity.

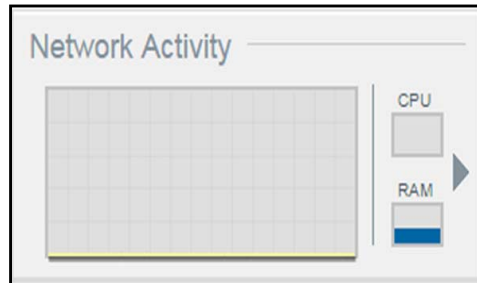

- To view a list of all the system activities and processes that are running on your My Cloud EX2 Ultra device, click the arrow on the right of the panel to display:
  - CPU:** Click the right arrow to view the CPU activity. Click **Back** to return to the Device Activity pane. Click **Close** to return to the Home page.

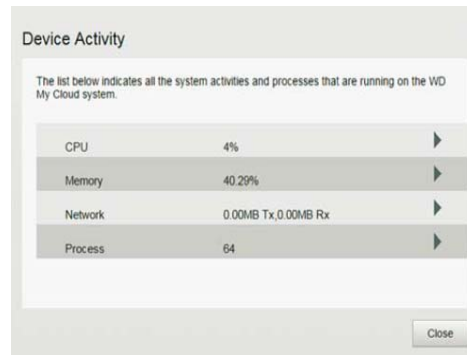

- Memory:** Click the right arrow to view the Memory activity. Click **Back** to return to the Device Activity pane. Click **Close** to return to the Home page.

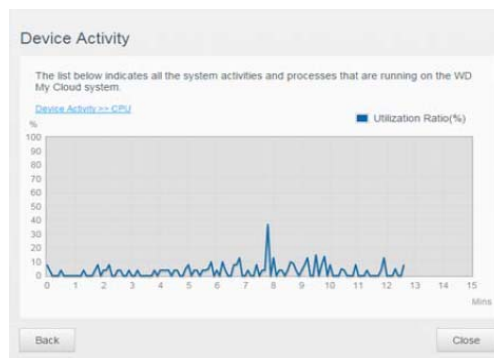

- **Network:** Click the right arrow to view the network activity. Click **Back** to return to the Device Activity pane. Click **Close** to return to the Home page.

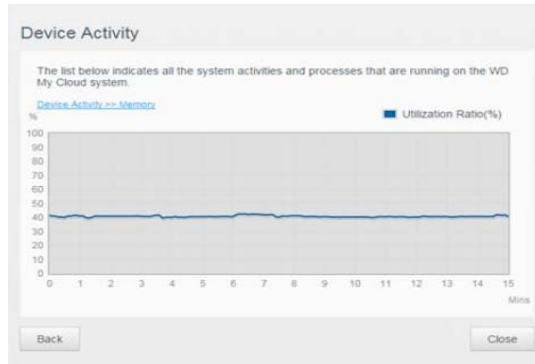

- **Process:** Click the right arrow to view the process information, including the list of active processes and the amount of CPU and Memory usage for each process. Click **Back** to return to the Device Activity pane. Click **Close** to return to the Home page.

pro



## Cloud Devices

The Cloud Devices panel displays the number of cloud devices currently accessing the My Cloud EX2 Ultra device remotely. In this example, one cloud device is accessing it

Process	CPU%	Memory Usage
elephantdrive	0.0	23.3
usrip_nas_device	0.0	13.8
htpd	0.0	8.9
htpd	0.0	8.9
htpd	0.0	8.9
htpd	0.0	8.9

The screenshot shows a 'Device Activity' window with a sub-panel for 'Process'. It displays a table with three columns: 'Process', 'CPU%', and 'Memory Usage'. The table lists several processes, including 'elephantdrive', 'usrip\_nas\_device', and multiple instances of 'htpd'. There are 'Back' and 'Close' buttons at the bottom.

remotely.

1. To add cloud access for a user, click the plus sign (+) in the lower right of the panel to display:
2. To generate an activation code, click the **Get Code** button.
3. Follow the page instructions to connect your tablet or mobile device to the My Cloud EX2 Ultra device.

## Users

The Users panel displays the number of users currently set up to use the My Cloud EX2 Ultra device.

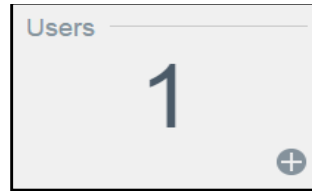

1. To add a user, click the plus icon the lower right of the panel:

*Note:* When you enter the email address on the Add User screen, a new account is created for cloud access. The user receives an email with instructions on how to activate and set up a password for cloud access.

2. Enter the required information and click **Next** to display a user password screen.
3. To assign a password, click the toggle button , enter a password, and then confirm your password. Click **Next** to display the user group screen.

 A screenshot of the 'Add User' form. It has a title 'Add User' at the top. Below the title are several input fields: 'User Name \*', 'First Name', 'Last Name', 'Email', 'Password', and 'Confirm Password'. The 'Email' field has a small information icon to its right. At the bottom right of the form, there is a note '\* Required'. At the very bottom, there are two buttons: 'Cancel' on the left and 'Apply' on the right.

4. To assign a group to the new user, click the check box next to a group, and then click **Next** to display the Add User screen.

 A screenshot of the 'Modify Quota' form. It has a title 'Modify Quota' at the top. Below the title is a form with a label 'Volume\_1 Quota Amount' and a text input field. To the right of the input field is a dropdown menu currently showing 'GB'. Below the input field, there is a note: 'Leave fields blank if you do not wish to set any user quotas.' At the bottom, there are two buttons: 'Cancel' on the left and 'Apply' on the right.

5. Enter the Quota Amount, or leave the values blank for unlimited space, and then click **Save**. You've added a new user.

## Apps

The Apps panel displays the apps currently installed on your My Cloud EX2 Ultra device.



1. To view the installed apps, click the arrow in the lower right of the panel to display:

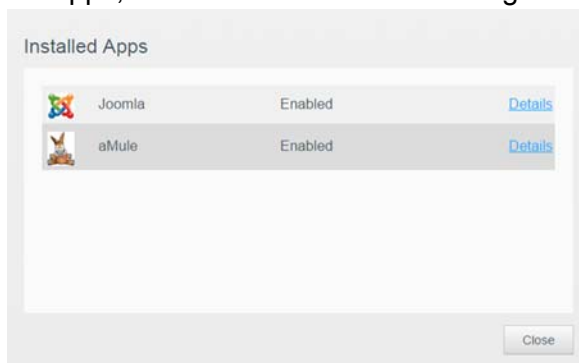



*Note:* To install an app, see “Managing Apps on My Cloud EX2 Ultra” on page 66.

2. To return to the Home page, click **Close**.

## Managing Alerts

Alerts display system messages containing pertinent information about the status of your My Cloud EX2 Ultra device. There are three types of alerts that appear on the upper right of the dashboard.

Alert Icon	Type of Alert	Description
	Informational	Informational alerts keep you updated on non-vital system information. Example: Reboot Required
	Warning	Warnings present a condition that might cause a problem in the future. Example: Network Disconnected.
	Critical	This alert presents an error or problem that has occurred, usually a system failure. Example: Fan Not Working

## Viewing Alert Details

1. On the dashboard, click the Alert icon  in the upper right corner.

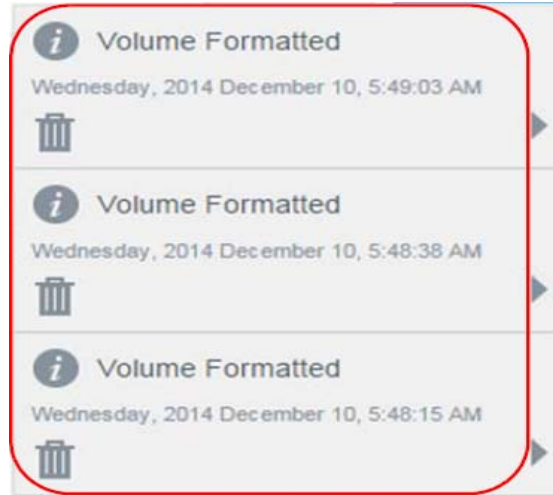

2. Select the arrow  next to the alert you'd like to view from the Alert list, or click **View All** to review details for all of your alerts.

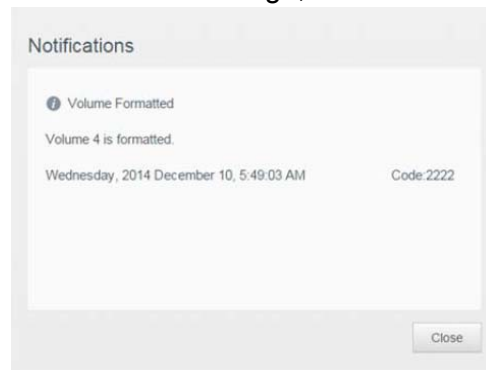

When an alert occurs, the alert message displays the Alert icon  and window within the dashboard. To close the alerts message, click **Close**.



### Dismissing an Alert

1. On the dashboard, click the Alert icon  in the upper right corner.
2. Select the delete icon  next to the alert you'd like to dismiss.  
To dismiss all alerts, click **View All**, and then **Dismiss All**.

## Obtaining Customer Support

To open the Support page:

1. Click the **Help** icon  on any page to display the Help menu.

2. Click **Support** to display the following page:

If a problem occurs with the My Cloud EX2 Ultra device, WD Technical Support will need information about your device to troubleshoot and determine the best solution. There are two ways to get your device info and request support:

- Run a system report and send it to WD automatically,
- Create a system report manually and send it to WD.

## Requesting Automatic Support

In the Request Automated Customer Support section:

1. Click the **Privacy Policy** link to review WD's privacy policy.
2. Click the **Attach my device's diagnostic report and request support** check box.
3. Click the **Request Support** button.

## Creating and Saving a System Report

In the Create and Save System Report section:

1. Click **Create and Save**. This saves the file to your computer.
2. If desired, email the report to WD Technical Support.

## Obtaining Other Support

In the Support Resources section are links to additional resources:

- To obtain the most recently updated user manual, click the **Product Documentation** link.
- To see answers to frequently asked questions and instructions, click the **FAQs** link.
- To discuss your My Cloud EX2 Ultra device with other users, click the **Forum** link.
- To see WD phone numbers and other contact information, click the **Contacts** link.



## Common Tasks

The next few chapters step you through the procedures for configuring and using the My Cloud EX2 Ultra device. The following table provides shortcuts to instructions for some common tasks.

How do I ...	See ...
Set up the device on my network	page 11
Use media servers	page 70
Enable DLNA and iTunes	page 72
Reboot or hibernate the My Cloud EX2 Ultra device	page 94
Update firmware	page 98
Access content from the device (public and private shares)	page 15
Add users	page 20
Create shares	page 27
Upload and back up content to the device	page 45
Back up the device	page 45
Enable or disable remote access for you and people you want to share with)	page 17
Download WD mobile apps	page 19

## 6

# Backing Up and Retrieving Files

- About Backups
- Managing a USB Device and USB Backups
- Remote Backups
- Internal Backups
- Cloud Backups

## About Backups

There are various ways to back up your data on the My Cloud EX2 Ultra device. These include:

- **USB Backup**—Allows you to back up My Cloud EX2 Ultra device data to and from your a USB device.
- **Remote Backup**—Allows you to back up My Cloud EX2 Ultra device data to and from another My Cloud device.
- **Internal Backup**—Allows you to back up data from one storage location to another on your My Cloud EX2 Ultra device.
- **Cloud Backup**—Allows you to backup My Cloud EX2 Ultra device data to an external cloud backup service.

## Managing a USB Device and USB Backups

When you attach a USB drive to the My Cloud EX2 Ultra device, you turn it into a network drive. Once connected, the USB drive has the following capabilities:

- When you connect an external USB drive such as a WD Passport, a memory stick, or a camera to the My Cloud EX2 Ultra device, you can access it with Windows Explorer or Mac Finder.
- The USB drive can serve as a target for backups.
- You now have the option of mapping the drive as a user share drive.
- If a WD external drive has been locked, when it is attached to the My Cloud EX2 Ultra device, it maintains that security. Using the Dashboard, you can unlock or re-lock it as desired.

## Connecting A USB Drive

Connect a USB hard drive to the USB port on the rear of your My Cloud EX2 Ultra device for additional storage and backup capabilities. The USB drive appears as a share on the My Cloud EX2 Ultra dashboard. (See “About Shares” on page 27.)

The My Cloud EX2 Ultra device supports the following formats for externally attached USB drives:

- FAT/FAT32
- NTFS (read and write capability)
- HFS+J
- Linux Ext2, Ext3/Ext4

---

**WARNING!** Mounting or ejecting a USB drive while performing an NFS or AFP file transfer will interrupt the file transfer process.

---

## Creating a USB Backup

Use the following steps to back up your data on your My Cloud EX2 Ultra to or from a USB device.

1. On the navigation bar, click **Backups** to display the Backups screen.

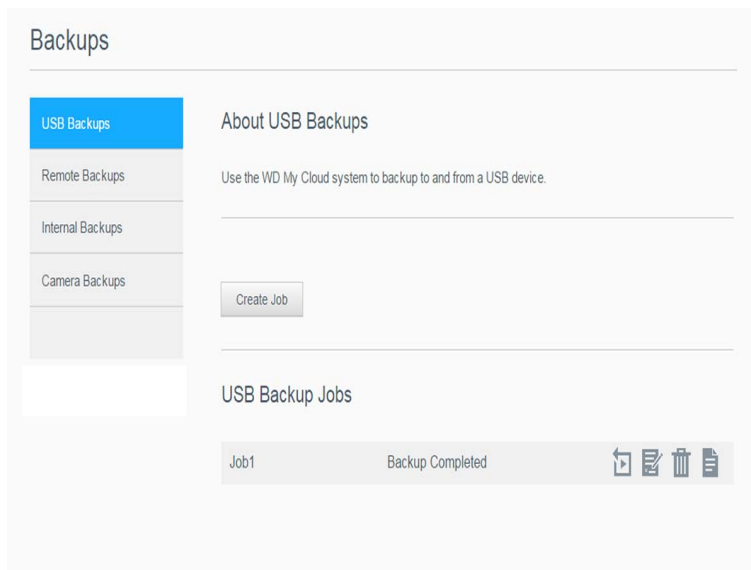

2. Click **USB Backups**, if not already selected.
3. Complete the following fields to create a USB backup job:

Job Name	Enter a Job Name for your backup.
Direction	Indicate the direction of your backup from the drop-down menu. Options include: <ul style="list-style-type: none"> <li>• USB to NAS: Backs up the data on your USB device to the My Cloud EX2 Ultra device.</li> <li>• NAS to USB: Backs up the data on your My Cloud EX2 Ultra device to a USB device.</li> </ul>
Source Folder	Click <b>Browse</b> and select the folder you'd like to back up.
Destination Folder	Click <b>Browse</b> and select the destination folder for your backup.

4. Click **Create**. This creates the backup job for the requested backup.

5. In the USB Backup Jobs area, click the arrow to begin your backup.

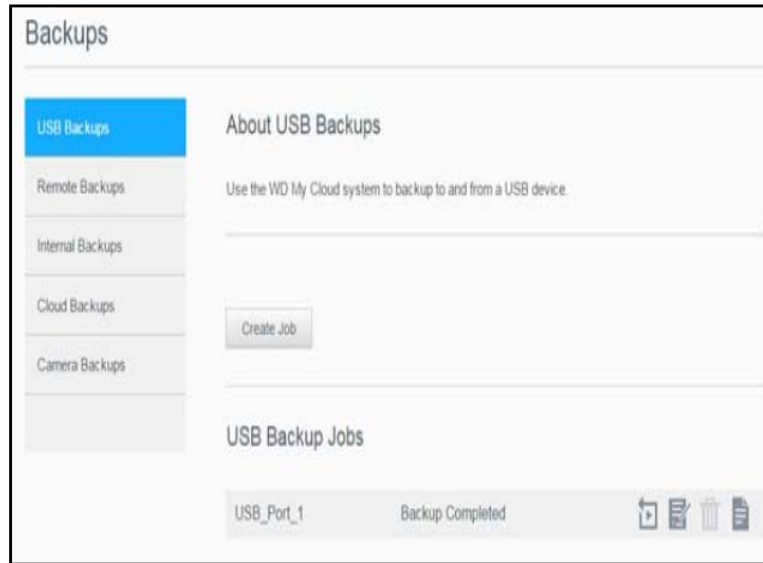

The progress of the backup displays in the USB Backup Jobs area.

## Viewing the Details of a USB Backup Job

1. On the USB Backups screen, under USB Backup Jobs, select the job you'd like to modify, and then click the **Edit Job** button .
2. Review the USB Details screen, and then click **Close** to close the screen.

## Editing a USB Backup Job

1. On the USB Backups screen, under USB Backup Jobs, select the job you'd like to modify, and then click the **Edit Job** button.
2. In the USB Backup area, make the necessary changes to your job, and then click **Save**.

## Deleting a USB Backup Job

1. On the USB Backups screen, under USB Backup Jobs, click the **Delete Job** button next to the job you'd like to delete.
2. In response to the confirmation message, click **OK**. The selected USB Backup job is now deleted and removed from the USB Backup Jobs list.

## Remote Backups

Back up your My Cloud EX2 Ultra device to another My Cloud EX2 Ultra or a My Cloud EX4 device.

Before you proceed with a remote backup, ensure the following:

- You have a remote My Cloud EX2 Ultra or My Cloud EX4 device to back up this device to. Existing shares and data from this device will be copied to the target device in addition to previously existing data.
- The remote Server setting is turned ON in the remote My Cloud EX2 Ultra or My Cloud EX4 device.

- The backup password for the remote My Cloud EX2 Ultra or WD M Cloud EX4 device is enabled.
- You have enabled port forwarding to see the remote My Cloud EX2 Ultra or My Cloud EX4 device over the Internet.

For additional information on remote backups, see Knowledge Base Answer ID 10637.

## Creating a Remote Backup

Use the following steps to back up your My Cloud EX2 Ultra to a remote device.

1. On the navigation bar, click **Backups** to display the Backups screen.
2. Click **Remote Backup**.

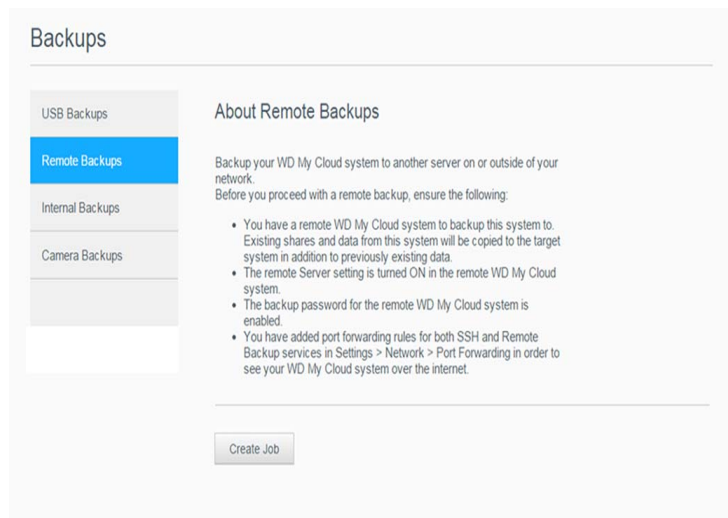

3. Click the **Create Job** button.
4. Place a check mark in the box next to the share you'd like to back up, and then click **Next**.
5. In the **Remote IP** field, enter the IP address of the remote backup server. (Example 192.168.1.16)
6. In the Password field, enter the password for the remote backup server, and then click **Next**.

7. Select the check box next to the share where you'd like to back up your data, and then click **Create**.

8. Complete the following fields to create a Remote backup job, and then click **Next**:

Job Name	Enter a Job Name for your backup.
Auto Update	Click the toggle button <input type="checkbox"/> to enable the Autoupdate feature.
Backup Now	Click <b>Yes</b> to begin your remote backup now. Click <b>No</b> to create a remote backup job for future backup.

9. Review the details of your Remote Backup job, and then click **Finish**.

### Viewing the Details of a Remote Backup Job

1. On the Remote Backup screen, under Remote Backup Jobs, click the **Details** button next to the job you'd like to view.
2. Review the Details screen, and then click **Close** to close the screen.

### Recovering a Remote Backup

Use the following steps to recover the data you saved on your remote server. This process recovers the data you saved on the remote server to your local server.

1. On the Remote Backup screen, under Remote Backup Jobs, click the **Recover** button next to the job you'd like to view.
2. On the Recover screen, click **OK**. Your data recovery begins.

### Deleting a Remote Backup

1. On the Remote Backup screen, under Remote Backup Jobs, click the **Delete** button next to the job you'd like to delete.
2. In response to the confirmation message, click **OK**. The selected Remote Backup job is now deleted and removed from the Remote Backup Jobs list.

## Internal Backups

Internal backups allow you to make backups of the existing content from one storage location to another on your My Cloud EX2 Ultra device.

### Creating an Internal Backup

Use the following steps to back up your My Cloud EX2 Ultra internally.

1. On the navigation bar, click **Backups** to display the Backups screen.
2. Click **Internal Backups**, if not already selected.
3. Enter the following information to create a USB backup job:

Job Name	Enter a Job Name for your internal backup.
Source Folder	Click <b>Browse</b> and select the folder you'd like to back up.
Destination Folder	Click <b>Browse</b> and select the destination folder for your backup.
Recurring Backup	<p>If you'd like to use the Recurring Backup feature:</p> <ol style="list-style-type: none"> <li>1. Click the toggle button <input type="checkbox"/> to enable the Recurring Backup feature.</li> <li>2. Select the frequency of the backup: Daily, Weekly, Monthly.</li> <li>3. Select a time (hour and minutes) from the drop-down menu.</li> <li>4. If you did not enable the Recurring backup field: <ul style="list-style-type: none"> <li>• Click the Date field and select the date you'd like the backup to occur.</li> <li>• Select a time of day (hour and minutes) from the drop-down menu.</li> </ul> </li> </ol>
Incremental Backup	Click the check box if you'd like this job to be an incremental backup.

5. Click **Create**. Your job displays in the Internal Backup Queue area and will begin backing up at the indicated time.

### Initiating an Immediate Internal Backup

- On the Internal Backups screen, under Internal Backup Queue, select the job you'd like to modify, and then click the **Begin Now** button.

The internal backup begins.

### Modifying an Internal Backup Job

1. On the Internal Backups screen, under Internal Backup Queue, select the job you'd like to modify, and then click the **Edit** button.
2. In the Internal Backup area, make the necessary changes to your job, and then click **Save**.

### Viewing Internal Backup Details

1. On the Internal Backups screen, under Internal Backup Queue, select the job you'd like to modify, and then click the **Details** button.
2. Review the details of your Internal Backup job, and then click **Close**.

## Deleting an Internal Backup Job

1. On the Internal Backups screen, under Internal Backup Queue, click the **Delete** button.
2. In response to the confirmation message, click **OK**. The selected Internal Backup job is now deleted and removed from the Internal Backup Jobs list.

## Cloud Backups

A cloud backup allows you to create remote backups that are accessible over the Internet and through various mobile devices. My Cloud EX2 Ultra device uses the following cloud services to create remote backups:

- **ElephantDrive:** ElephantDrive is a cloud backup service that provides secure and automatic backups to your files remotely.
- **Amazon S3:** Amazon Simple Storage Service (S3) is an online file storage web service that can be used to store and retrieve any amount of data, at any time, from anywhere on the web.

## Enabling ElephantDrive Cloud Backup

ElephantDrive is a cloud backup service that provides secure and automatic backups to your files remotely. Once enabled, ElephantDrive automatically syncs with your device. For additional information about ElephantDrive Cloud Backups, see <http://home.elephantdrive.com/welcome/wdc/>.

Use the following steps to enable a cloud backup using ElephantDrive.

1. On the navigation bar, click **Backups** to display the Backups screen.
2. Click **Cloud Backups**, if not already selected.

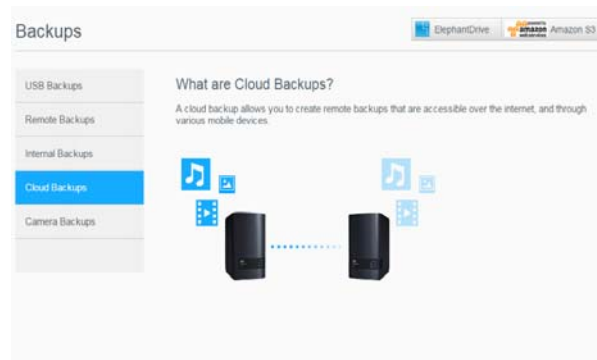

3. Click **ElephantDrive** at the top of the screen.



4. In the ElephantDrive field, click the toggle button  to turn on your ElephantDrive cloud backup.
5. Click **Register**. The Register screen displays.



6. Enter the following information, and then click **Register**:
  - **Email address:** Enter the email address you'll use to receive information from ElephantDrive.
  - **Password:** Enter a password for your new account
  - **Verify Password:** Reenter your password.
7. You've now enabled your ElephantDrive cloud backup.

## Backing Up with ElephantDrive

Once you've enabled ElephantDrive, use the following steps to create a cloud backup.

1. On the navigation bar, click **Backups** to display the Backups screen.
2. Click **Cloud Backups**, if not already selected.
3. Click **Elephant Drive** at the top of the screen.

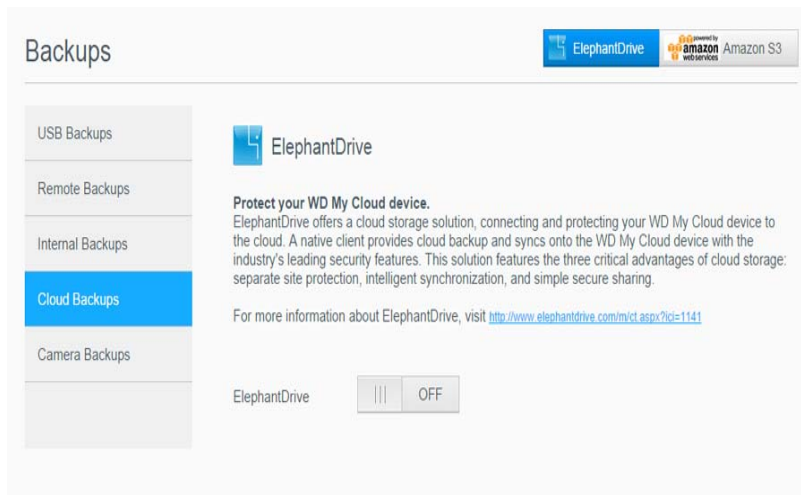

4. In the Access Backups field, click **Login**.
5. Enter the email and password you used when you registered with ElephantDrive in Step 6 on page 52. Click **Login**.
6. In the Elephant Drive field, click the **New device backup wizard link**.
7. Follow the steps outlined in the ElephantDrive backup wizard to create your cloud backup.

## Enabling an Amazon S3 Cloud Backup

*Note:* Before creating your Cloud backup, sign up for the Amazon S3 service at <http://aws.amazon.com/s3>.

Once your Amazon S3 account is set up, use the following steps to create a cloud backup.

1. On the navigation bar, click **Backups** to display the Backups screen.
2. Click **Cloud Backups**, if not already selected.

3. Click the **Amazon S3** button at the top of the screen.

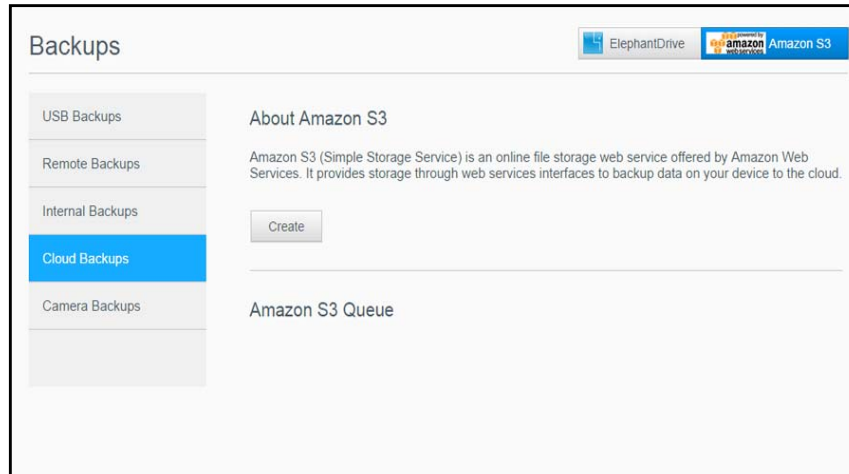

4. Click **Create**.

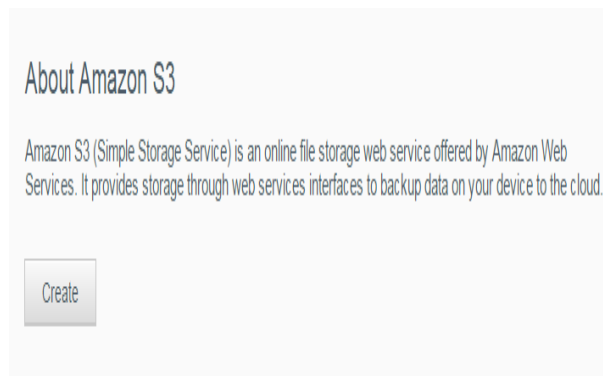

5. Enter a Job Name for your cloud backup, and then click **Next**.



6. Enter the following information supplied by Amazon S3:
  - **Region:** Select the region used for your cloud from the drop-down menu.
  - **Access Key:** Enter the access key supplied to you by Amazon S3.
  - **Private Key:** Enter the private key supplied to you by Amazon S3.
  - **Remote Path:** Enter the remote path for your cloud. This is normally your bucket name.

7. Click **Next**.



8. Enter the following information, and then click **Next**:

Type	<p>Select one of the following options:</p> <ul style="list-style-type: none"> <li>• <b>Upload:</b> Backs up your My Cloud EX2 Ultra data to your Amazon S3 bucket.</li> <li>• <b>Download:</b> Backs up your Amazon S3 bucket to your My Cloud EX2 Ultra device.</li> </ul>
Backup Type	<p>From the drop-down menu, select the type of backup you'd like to perform. Options include:</p> <ul style="list-style-type: none"> <li>• <b>Overwriting existing file(s):</b> Overwrites files in the target folder that have the identical name as your source file.</li> <li>• <b>Full Backup:</b> Creates a separate folder containing all of the backup data each time the backup is performed.</li> <li>• <b>Incremental Backup:</b> Overwrites files with source files that are newer than the target files.</li> </ul>

9. In the Local Path field, enter a path for your backup on your My Cloud EX2 Ultra server.
  - Click **Browse** to browse to a location for your backup on the device. (Example Volume\_1/backup)
10. Click the toggle button  to activate the Autoupdate feature. This automatically updates your backup based on a schedule you create.
  - If you activate the Autoupdate feature:
    - Select the Autoupdate schedule: Daily, Weekly, or Monthly
    - Select the Autoupdate Time from the drop-down menu (Daily option).
  - Select Autoupdate Date and Time from the drop-down menus (Weekly or Monthly option).
11. If you don't select Autoupdate, in the Backup Now field, indicate whether you want to begin the backup now.
  - Select **Yes** to begin your backup now.
12. Click **Next**.
13. Review your settings, and then click **Finish**. Your Amazon S3 Cloud backup is created. The new job displays in the Amazon S3 Queue section of the Amazon S3 Backup page.
14. Access your Amazon S3 Cloud backup bucket to view your device backups.

## 7

# Managing Storage on My Cloud EX2 Ultra

[Storage Types](#)  
[RAID Storage](#)  
[iSCSI Storage](#)  
[Volume Virtualization](#)

## Storage Types

There are several ways to manage your storage on the My Cloud EX2 Ultra device:

- RAID Storage
- iSCSI
- Volume Virtualization

The Storage page allows you to configure the storage within your device and view the status and capacity of the disks within your device. This chapter provides details on managing the storage on your My Cloud EX2 Ultra device.

### Storage

---

RAID

Disk Status

iSCSI

Volume Virtualization

#### RAID Profile

RAID Health      Healthy

All RAID Volumes are active and healthy.

---

#### RAID Volume

Volume_1	JBOD	1.96 TB	Good
----------	------	---------	------

[Change RAID Mode](#)

## RAID Storage

RAID (Redundant Array of Independent Disks) allows you to store the same data in different places on multiple hard drives, providing necessary redundancy, greater performance, and data integrity. There are several different levels of RAID, each one providing a different method of sharing or distributing data among the drives. Your My Cloud EX2 Ultra device allows you to select from the following storage modes:

RAID Mode	Description
JBOD	The use of one or more drives not in a RAID configuration but managed as separate logical volumes.
Spanning	Combination of drives in a linear fashion to create one large logical volume.
RAID 0	RAID 0 mode provides disk striping across all drives in the RAID drive group. RAID 0 does not provide data redundancy but does provide the best performance of any RAID levels. RAID 0 breaks up data into smaller segments and stripes the data segments across each drive in the drive group.
RAID 1	In RAID 1 mode, the RAID controller duplicates all data from one drive to a second drive in the drive group. RAID 1 provides complete data redundancy but cuts the required storage capacity in half.

### Viewing the Current RAID Mode

Use the following steps to view the RAID mode currently being used on your device.

1. On the navigation bar, click **Storage** to display the Storage screen.
2. Click **RAID**, if not already selected.

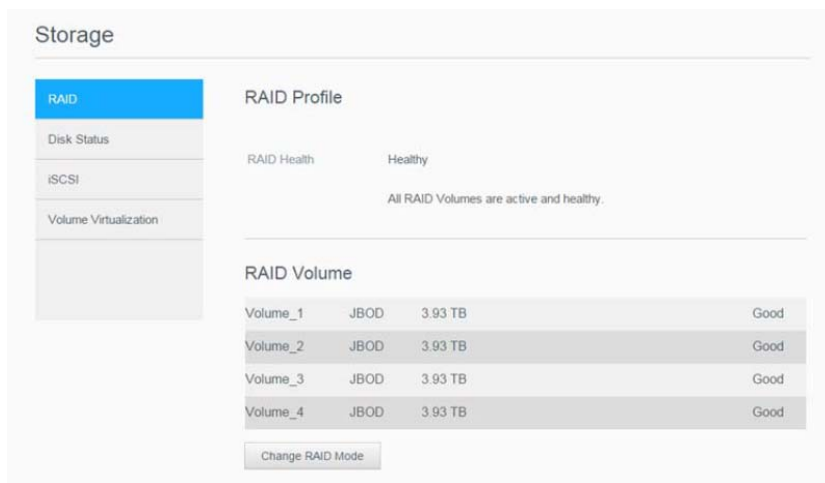

3. In the RAID Profile, the following information displays:
  - RAID Health
  - Auto-Rebuild status
  - RAID Volume

## Changing the RAID Mode

Use the following steps to change the current RAID mode on your My Cloud EX2 Ultra device.

---

**WARNING!** Changes made to your RAID Mode will delete all of your data and your user settings. See “Saving a Configuration File” on page 94 for information on saving your user settings.

---

1. On the navigation bar, click **Storage** to display the Storage screen.
2. Click **RAID**, if not already selected.

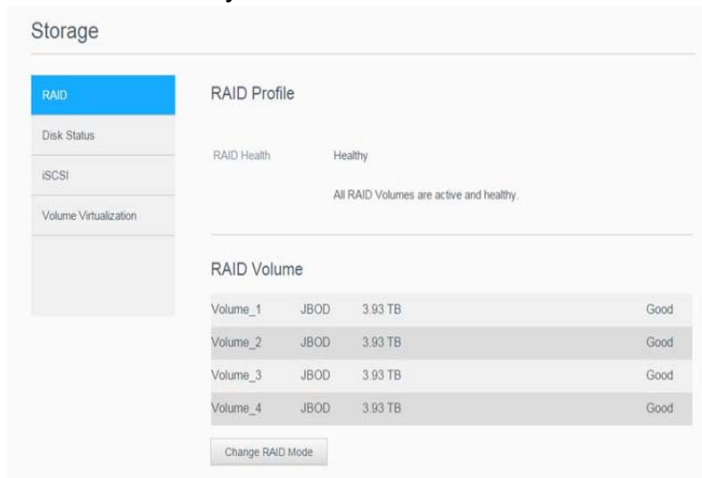

3. Click **Change RAID Mode** at the bottom of the screen.
4. Review the Warning message, and then click **OK**.
5. Select the RAID mode you'd like to use for your My Cloud EX2 Ultra device. Options include:

JBOD	The use of one or more drives not in a RAID configuration but managed as separate logical volumes.
Spanning	Combination of drives in a linear fashion to create one large logical volume.
RAID 0	Data is striped across multiple hard drives, enabling accelerated reading and recording of data by combining the work of two or more drives to increase performance.
RAID 1	Two instantaneous copies of the data are recorded on separate hard drives so if one of them fails, other(s) continue to read/write data until the faulty hard drive is replaced.

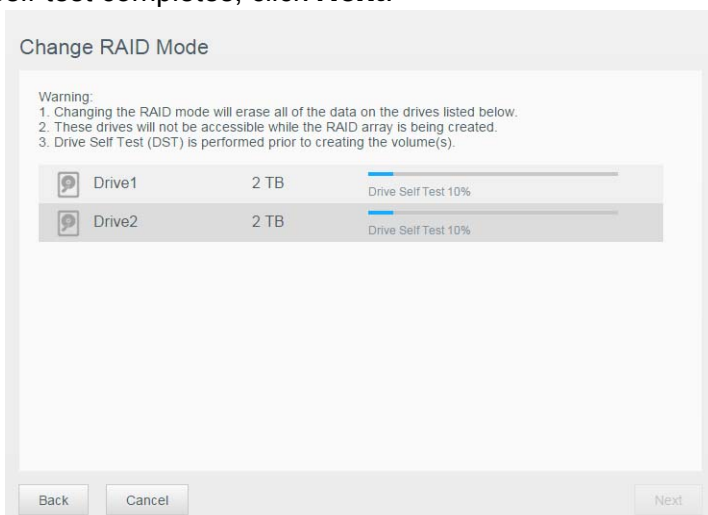

6. Select the **Switch to <RAID Mode>** check box, and then click **Next**. Review the status of your hard drives, and then click **Next**.

7. After the self-test completes, click **Next**.



8. Select the type of encryption you'd like on the volume.

**Note:** Encryption is not available for certain regions.

- Click  to encrypt the selected volume.
- Click  to keep the volume unencrypted.

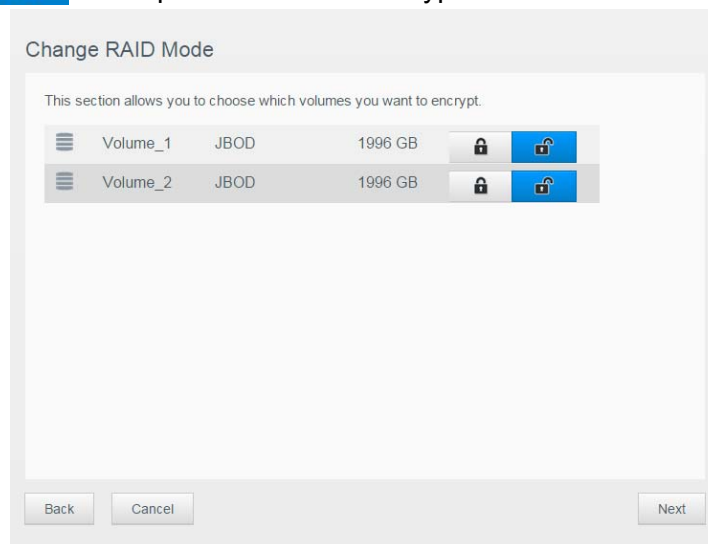



- Review the summary of your selections, and then click **Next**.

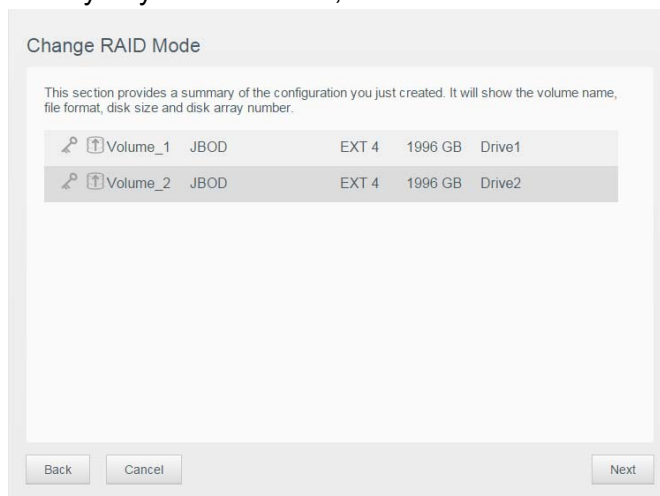

- Review the warning screen, and then click **Finish**.
- The requested hard drive changes begin. Do not turn off your My Cloud EX2 Ultra device while these changes are in progress.
- When the process is complete, click **Finish** again.

## Auto-Rebuilding your RAID

The Auto-Rebuilding option allows you to automatically rebuild the RAID for your My Cloud EX2 Ultra device in case of drive corruption. Use the following steps to enable the auto-rebuild option.

- On the navigation bar, click **Storage** to display the Storage screen.
- Click **RAID**, if not already selected.
- Review the **Auto-Rebuild** field to determine whether your My Cloud EX2 Ultra device is currently set up for auto-rebuild.
  - If Auto-Rebuild is off, click the toggle button  to enable Auto-Rebuild.

## Disk Status

The Disk Status screen identifies the health of the disk drives as well as the status and information on each drive used in your My Cloud EX2 Ultra device. The Disk Status screen consists of the following areas:

- Disks Profile:** This area displays the general status of all of the disk drives on your device.
- System Disks:** This area identifies the drives on your device, the status of each drive, and the amount of space on that drive.

*Note:* If a drive is unsuitable, the status is **not compatible**.

## Viewing Hard Drive Information

Use the following steps to view status of the disks on your My Cloud EX2 Ultra device.

1. On the Storage page, click **Disk Status**, if not already selected.
2. Select **Drive <drive #>** next to the disk for which you'd like to view information.
3. Review the hard drive information, and then click **Close**.

The Hard Drive Information screen displays the following data:

Vendor	The vendor from whom the hard drive was obtained.
Model	The model number of the hard drive selected.
Serial Number	The serial number of the hard drive selected.
Capacity	The capacity of the hard drive selected.
Firmware Version	The current firmware version used on the drive selected.

## iSCSI Storage

Internet SCSI (iSCSI) is an industry standard developed to enable transmission of iSCSI block storage commands and data over an existing IP network by using the TCP/IP protocol. The encapsulated iSCSI commands and data can be transmitted over a local area network (LAN) or a wide area network (WAN). As with traditional SCSI, an iSCSI storage solution requires at least one "initiator" residing on the client computer and at least one "target" residing on the storage server.

Once the connection is established between the iSCSI initiator and the iSCSI target, the operating system on the iSCSI initiator sees the storage as a local storage device that can be formatted, read, and written in the usual manner.

My Cloud EX2 Ultra allows you to create and manage iSCSI targets. The iSCSI target provides storage, similar to a local hard disk drive, but is accessed over a network rather than locally. The iSCSI target is protected by the underlying RAID structure of the My Cloud EX2 Ultra server.

### iSCSI Roles

- **Initiator:** A client computer that accesses storage devices using iSCSI commands over an IP network.
- **Target:** A network-attached storage device that provides access to logical disks (which can be created on the My Cloud EX2 Ultra server).

## Creating an iSCSI Target

Use the following steps to create an iSCSI target

1. On the navigation bar, click **Storage** to display the Storage screen.
2. Click **iSCSI**, if not already selected.
3. Click the toggle button  to enable iSCSI.
4. Click **Create iSCSI Target** at the bottom of the screen.
5. On the Create iSCSI Target screen, enter the following information:

- **Alias:** Descriptive name for your target.
- **Created On:** The Volume where you'd like the iSCSI target to reside.
- **Size:** The size of your target and the unit of information storage for that size (e.g. GB, TB).

6. Click **Next**. The Create iSCSI Target screen displays:

7. If you'd like to assign security for your target:
- a. Click **CHAP**.
  - b. Enter an existing User Name and Password, and then confirm the Password.
8. Click **Apply**. Your new iSCSI target is created and displays in the iSCSI Target List.

## Enabling / Disabling an iSCSI Target

Use the following steps to enable or disable an iSCSI target.

### Enabling an iSCSI Target

1. On the Storage page, click **iSCSI**.
2. Under iSCSI Target list, click **Details** next to the target you'd like to enable.
3. Click **Enable**. The selected target is now enabled.

### Disabling an iSCSI Target

1. On the Storage page, click **iSCSI**.
2. Under iSCSI Target list, click **Details** next to the target you'd like to disable.
3. Click **Disable**. The selected target is now disabled.

## Modifying an iSCSI Target

Use the following steps to modify an iSCSI target.

1. On the Storage page, click **iSCSI**.
2. Under iSCSI Target list, click **Details** next to the target you'd like to modify.
3. Make all of your necessary changes, and then click **Save**.

## Deleting an iSCSI Target

Use the following steps to delete an iSCSI target.

1. On the Storage page, click **iSCSI**.
2. Under iSCSI Target list, click **Details** next to the target you'd like to delete.
3. Ensure that this is the target you want to delete, and then click **Delete**. The selected target is deleted and removed from the iSCSI Target list.

## Enabling iSCSI iSNS Client

The Internet Storage Name Service (iSNS) protocol is used for interaction between iSNS servers and iSNS clients. iSNS clients are computers, also known as initiators, that are attempting to discover storage devices, also known as targets, on an Ethernet network. Use the following steps to configure the iSCSI iSNS client.

1. On the navigation bar, click **Storage** to display the Storage screen.
2. If not already selected, click **iSCSI**.

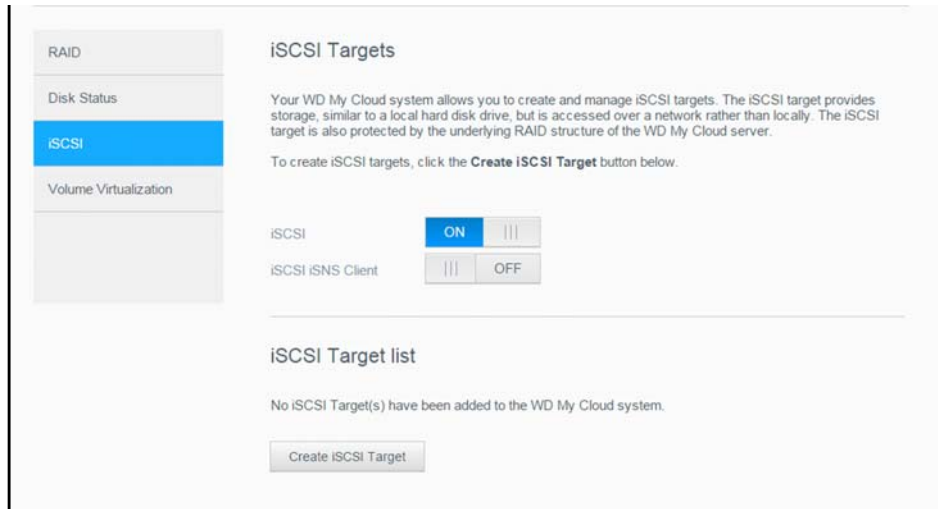

3. Click the toggle button  to ON to enable iSCSI.
4. In the iSCSI iSNS Client field, click the toggle button .
5. Click **Configure**.
6. Enter the iSNS client server address, and then click **Apply**.

## Volume Virtualization

Volume Virtualization simplifies scalability by allowing you to map iSCSI targets on other network storage devices and present them as volumes on your My Cloud EX2 Ultra device.

## Creating a Virtualized Volume

Use the following steps to create a virtualized volume on your device.

1. On the Storage page, click **Volume Virtualization**, if not already selected.
2. Click **Create** to display the Create Volume Virtualization screen:

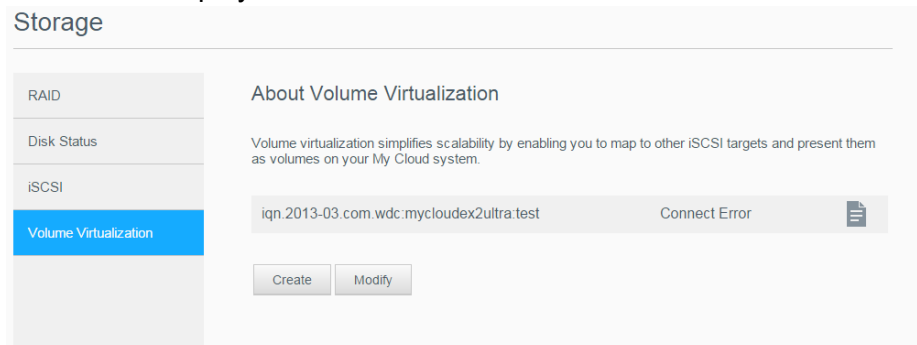

3. In the Device IP field, enter the IP address of the device where the iSCSI target resides, and then click **Next**.

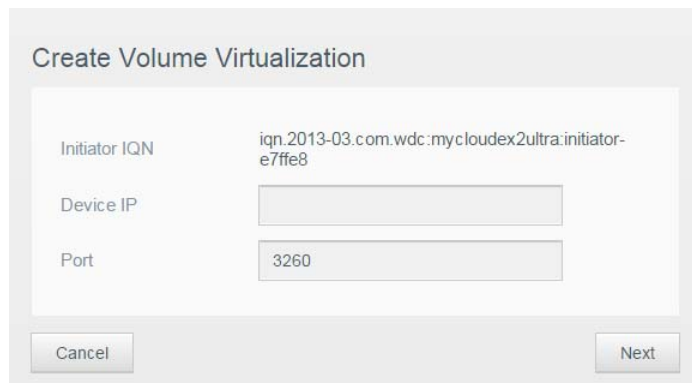

4. Select an iSCSI target from the retrieved list, and then click **Next**.
5. To add authentication to the target, click the toggle button  to ON, enter a User Name and Password, and then click **Next**.
  - Disabled authentication is the default. To keep the default, ensure that the Authentication field is OFF, and then click **Next**.
6. Select a LUN (Local Unit Number) from the list, and then click **Next**.
7. Enter a name for the share folder, and then click **Next**.
8. Review the Volume Virtualization summary to ensure that your settings are correct, and then click **Save**. A virtual volume is created.

## Connecting a Virtualized Volume to a Target

Use the following steps to connect a virtualized volume to a target on your device.

1. On the Storage page, click **Volume Virtualization**, if not already selected.
2. Click **Details** next to the virtual volume you'd like to connect.
3. Click **Connect**. Once connected to the target, the system automatically formats the LUN, if it hasn't been done before.
4. Once your virtual volume is formatted, click **Close**. The state of the volume is changed to Connect.

Your new virtual volume is now available on your My Cloud EX2 Ultra device.

## Modifying a Virtualized Volume

Use the following steps to modify a virtualized volume on your device.

1. On the Storage page, click **Volume Virtualization**, if not already selected.
2. Select the virtual volume you'd like to modify, and then click **Modify**.
3. Make the necessary changes to the volume, and then click **Save**. When the modified settings are saved, the virtual volume is connected again.

## 8

# Managing Apps on My Cloud EX2 Ultra

[About Apps](#)  
[Managing Apps](#)

## About Apps

Apps is short for Applications. Apps are little self-contained programs used to enhance the existing functions of your device or service. The My Cloud EX2 Ultra device provides various apps that allow you to use your device more productively.

**Note:** WD recommends that you fully understand the nature of any app before you install it on your device.

**Note:** Support for each app should be obtained through the individual vendor.

My Cloud EX2 Ultra comes with various apps installed. There is also a list of available apps for you to choose from on the Add an App screen.

## Managing Apps

The Apps screen displays a list of the currently installed apps. From this screen, you can use your installed apps, add new apps, or remove apps you no longer want to use.

## Viewing Apps

1. On the navigation bar, click **Apps** to display the Apps screen:

The screenshot shows the 'Apps' management interface. On the left, there is a vertical list of app categories: 'HTTP Downloads' (highlighted in blue), 'FTP Downloads', 'P2P Downloads', and 'Web File Viewer'. Below this list are two small icons representing a folder and a file. On the right, the configuration details for the selected 'HTTP Downloads' app are shown. It includes a 'Login Method' section with 'Account' and 'Anonymous' buttons, where 'Anonymous' is selected. Below that are input fields for 'URL', 'Save To', and 'Rename', each with a corresponding button ('Test', 'Browse', and an information icon). There is a 'Recurrence' section with a calendar icon and an 'OFF' button. The 'When' section includes a 'Date' field set to '2015-11-02' and a 'Time' field set to '9AM : 22'. At the bottom of the right pane is a 'Create' button.

2. To select an app, click the name of the app in the left pane. The app displays in the right pane.

## Adding an App

Use the following steps to add an app to your My Cloud EX2 Ultra device.

1. On the navigation bar, click **Apps** to display the Apps screen.
2. Click the **Add an App** icon  in the lower left side of the screen. The first time you add an app, the Terms of Service screen displays. Read and accept the agreement.
3. On the Add an App screen, place a check next to the app you'd like to add to the device.
4. For details about the app, click **Details**. Close the Details screen.
5. Place a check next to the app(s) you'd like to add to your device, and then click **Install**. The selected apps are added to your device.



## Manually Adding an App

If you have an app you'd like to add that is not listed on the Add an App screen, use the following steps to manually add that app to your My Cloud EX2 Ultra device.

*Note:* WD recommends that you fully understand the nature of any app before you install it on your device.

1. On the navigation bar, click **Apps** to display the Apps screen.
2. Click the Add an App icon  in the lower left side of the screen.
3. Scroll to the bottom of the Add an App screen, and then click the **To install manually, click here** link.
4. Navigate to the app you'd like to install on your device.
5. Select the app, and then click **Open**.
6. The selected app is added to your device.

## Deleting an App

Use the following steps to delete an app from your My Cloud EX2 Ultra device.

1. On the navigation bar, click **Apps** to display the Apps screen.
2. From the Apps list in the left pane, select the app that you'd like to delete from the device.
3. Click the **Remove an App** icon  in the lower left side of the screen.
4. In response to the confirmation message, click **OK**. The app is removed from the device and no longer displays in the user account list.

## Updating an App

Use the following steps to update an app that you've added to your My Cloud EX2 Ultra device.

1. On the navigation bar, click **Apps** to display the Apps screen.
2. If there is an update for one of the apps you've added to your device, an Updates available link displays at the top right of the screen.
3. Click the **Updates Available** link.
4. Select the app you'd like to update from the list, and then click **Update**.
  - If you'd like to view the details of the update, click **Details**.
  - Click **Back** to return to the Update screen.

# Playing/Streaming Videos, Photos, & Music

Media Servers

Media Storage

Enabling DLNA and iTunes

Accessing Your Private Cloud Using Media Players

Accessing Your Private Cloud Using iTunes

## Media Servers

My Cloud EX2 Ultra is designed to serve as your home's media server. It enables you to stream photos, music, and videos to your DLNA-compatible devices and music to your iTunes-compatible devices.

Both DLNA-compatible and iTunes-compatible devices search for media stored in any Public share that has media serving enabled. By default, DLNA Media is disabled. Once you enable it on the Settings > Media Server page, the media serving for the Public share is also automatically enabled. For all other shares, the media serving remains off.

If you do not want DLNA to display specific media files, place them in a private share that is set to disable media sharing. (See “Making a Share Private” on page 30.)

## Media Server Overview

The My Cloud EX2 Ultra device uses TwonkyMedia as its DLNA media server. It streams your music, photos and videos to compatible devices in your home. Playing media on a compatible device is easy.



The media server searches for all the media stored in the Public share on the My Cloud EX2 Ultra device connected to your home network. After enabling media serving for the device (see “Enabling DLNA and iTunes” on page 72), you can just transfer your multimedia content to the Public share on your My Cloud EX2 Ultra device, and you are ready to stream and view content on your home entertainment center, game consoles (for example, Xbox 360® or PlayStation® 3), WD TV Live® media player, or DLNA® 1.5 digital media adapters), and other PC computers on your home or office network. Visit <http://www.dlna.org> for further information on DLNA.

## iTunes Overview

You or anyone connected to the My Cloud EX2 Ultra device can use iTunes to play stored music files. iTunes creates a virtual music library on the device and treats it as an iTunes repository, making it possible to stream music files from the My Cloud EX2 Ultra device to Windows or Mac computers running iTunes.

iTunes scans any shares that have the Media Serving setting enabled, including the Public share by default.

## Media Types Supported

 Audio files	 Video files	 Image Files
3GP	3GP	BMP
AAC	ASF	JPEG
AC3	AVI	PNG
AIF	DivX	TIF
ASF	DV	
FLAC	DVR-MS	
LPCM	FLV	
M4A	M1V	
M4B	M2TS	
MP1	M4P	
MP2	M4V	
MP3	MKV	
MP4	MOV	
MPA	MP1	
OGG	MP4	
WAV	MPE	
WMA	MPEG1	
	MPEG2	
	MPEG4	
	MPG	
	MTS	
	QT	
	QTI	
	QTIF	
	RM	
	SPTS	
	TS	
	VDR	
	VOB	
	WMV	
	Xvid	

*Note:* Some devices may not support playback of all these files. Please refer to your device's user manual to see which formats are supported.

## Media Types Supported by iTunes

*Note:* iTunes 10.4 or later only supports music files. See Knowledge Base Answer ID 8412 for additional information on iTunes-supported versions.

The iTunes Media Server supports the following file extensions: FLAC, M4A, MP3, MP4A and WAV.

*Note:* Some devices may not support playback of all these files. Please refer to your device's user manual to see which formats are supported.

## Media Storage

You can access and store media content on the My Cloud EX2 Ultra device by means of network shares. Shares, similar to folders or directories, are areas set up to organize media and access them from your network. Shares can be shared with everyone (public) or with selected users on your network (private).

The device comes pre-configured with the Public network share, which contains the following folders for media storage:

- **Shared Music**—Stores music files you want to share with other users.
- **Shared Pictures**—Stores image files you want to share with other users.
- **Shared Videos**—Stores video files you want to share with other users.

*Note:* You will notice that the Public share's Shared Music and Shared Pictures shares contain mirrored and uploaded subfolders. These folders are needed by Twonky 7.2. You can now upload all media types to the uploaded subfolder from a DLNA client with "upload" capability.

Go to the Twonky configuration site (NAS\_IP:9000) to aggregate content from all NAS devices with DLNA capability on your network to the mirrored folder. Uploading and mirroring are best left to expert users, as these features are not supported by WD customer support.

## Enabling DLNA and iTunes

The Media page of the Settings Screen allows you to enable or disable the DLNA and iTunes media servers. Media server utilities for re-scanning the NAS or fully rebuilding the DLNA database are also on the Media page.

### Enabling DLNA

1. On the Navigation bar, click **Settings** and then click **Media** in the left panel.

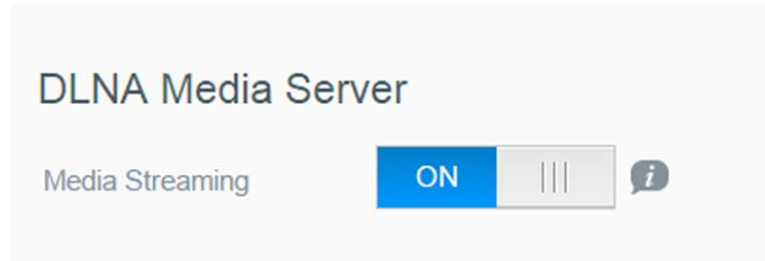

1. In the DLNA area Media Streaming field, click the toggle button  to enable DLNA.

*Note:* Media Streaming is OFF by default. To enable DLNA, click the toggle  button to ON. The media server must be enabled before you can provide media serving for a share. (See “Creating a New Share” on page 29 for instructions on how to enable media serving on a share.)

2. Click **View Media Players**. This displays a list of the media players/receivers on your home network.

*Note:* If Media Streaming is OFF, this field will not display on your screen.

3. On the Media Streaming Options screen, select the media device you'd like to receive streaming music, video, or photos.

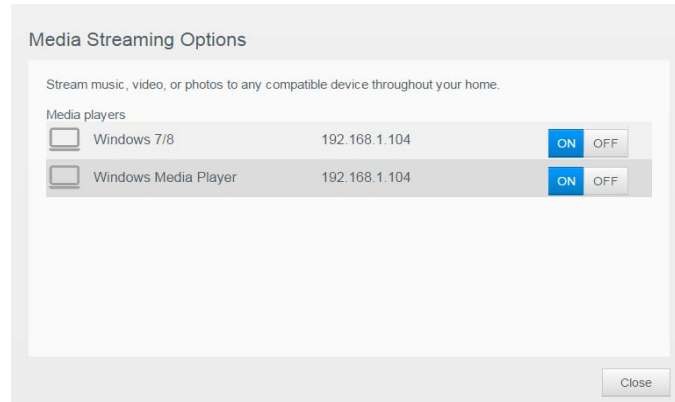

- **On:** Select this option to allow DLNA media streaming to the device.
  - **Off:** Select this option to disable DLNA media streaming to the device.
4. Once your selections are made, click **Close**.

### Viewing DLNA Media Server Information

The DLNA area displays the current version, the number of music, video, and pictures available on your device, and when the last update occurred.

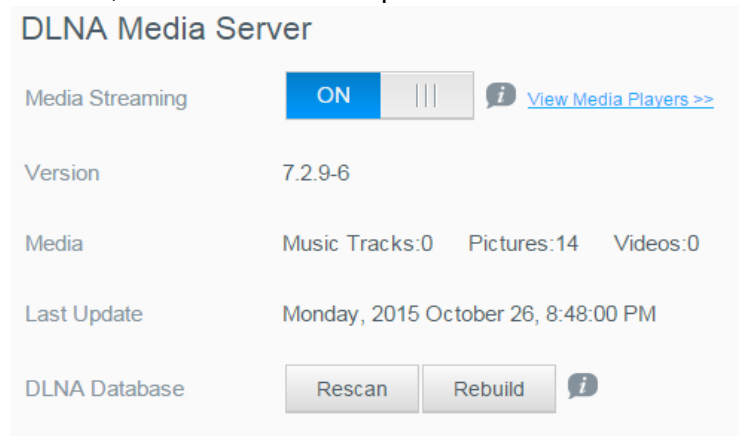

- To view DLNA media server information, on the Settings screen, click **Media** in the left panel.

## Rescanning/Rebuilding the DLNA Database

The My Cloud EX2 Ultra device automatically rescans and rebuilds the DLNA database; however, if you suspect that your database is corrupted, use the following steps to either rescan or rebuild your DLNA database:

---

**Important:** Use caution when completing this procedure. Rebuilding the DLNA server database could take a considerable amount of time, depending on the number and size of the files involved.

---

1. On the Navigation bar, click **Settings** and then click **Media** in the left panel.
2. In the DLNA Database field, click one of the following.
  - **Rescan:** The My Cloud EX2 Ultra device searches for changes made to your media libraries. Try this option first.
  - **Rebuild:** The My Cloud EX2 Ultra device rebuilds the DLNA database from scratch.

## Enabling iTunes

1. On the Navigation bar, click **Settings** and then click **Media** in the left panel.

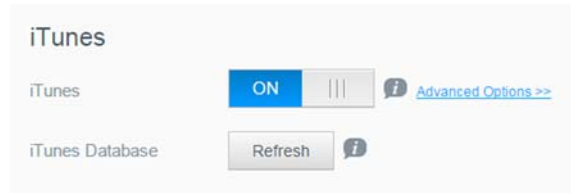

1. In the iTunes area iTunes field, click the toggle button  to enable iTunes (if not already enabled).

*Note:* iTunes is ON by default. To disable it, click the toggle button  to OFF.

2. In the Folder field, select **Root**, if not previously selected. This field points iTunes to the root directory on your My Cloud EX2 Ultra device.
  - If you want to specify a directory on your device where iTunes can access your media:
    - Deselect the Root check box.
    - Click **Browse**, and then navigate to the folder where iTunes can access your media.
    - Click **Apply** at the bottom of the iTunes area.
3. In the Password field, enter a password to be used when accessing your My Cloud EX2 Ultra device on iTunes.

*Note:* Leave the Password field blank if you don't want to use a password to access your device media in iTunes.

4. If you'd like to change the default MP3 Tag Code page, select the page from the drop-down menu.
5. For Auto Refresh, select the frequency of the media refresh for iTunes from the drop-down menu.
6. Click **Apply** to save your settings.

## Refreshing iTunes

Use the following steps to refresh the iTunes directory. This allows iTunes to pick up any new media.

1. On the Navigation bar, click **Settings** and then click **Media** in the left panel.
2. In the iTunes database field, click **Refresh**.

## Adding Media Content to the Folders

1. Open **Windows Explorer** or **Mac Finder**.

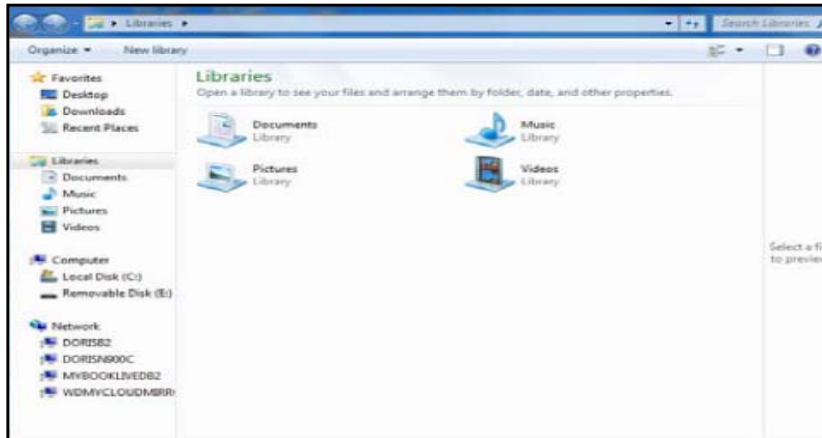

**Windows Explorer**

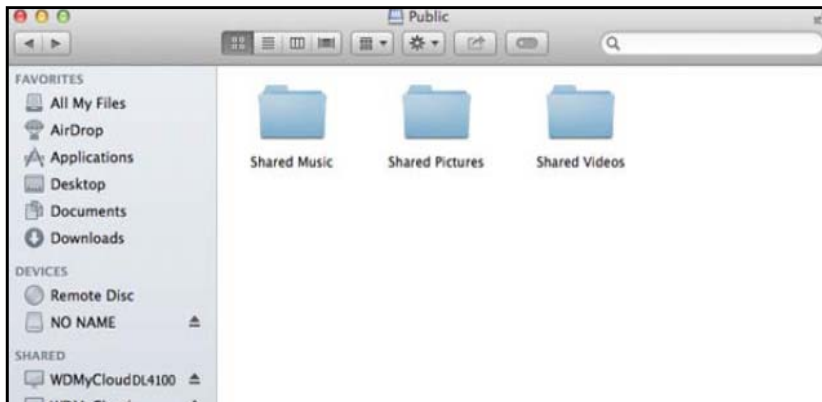

**Mac Finder**

2. Copy your music files to the Shared Music folder.
3. Follow the same process to place your videos and pictures into their respective Pictures and Video folders.

*Note:* You can also access your media files using My Cloud Desktop app (see “My Cloud for Desktop App” on page 26).



## Accessing Your Private Cloud Using Media Players

Now that you have copied your files to one of the Shared folders, you can use a variety of media players to stream media. The following types are supported:

- WD TV Live Media Players
- Windows Media Player 11 (comes with Windows Vista)
- Windows Media Player 12 (comes with Windows 7 and Windows 8)
- Xbox 360
- PlayStation 3
- Other media players:
  - BluRay Players
  - Network Connected TVs
  - Digital Picture Frames
  - Network Music Player
- DLNA Devices

*Note:* For specific information on using and updating the media player, go to the appropriate support site.

### WD Media Players

You can connect the various WD TV and WD Media Players to your home network for access to media content stored in a network drive such as the My Cloud EX2 Ultra device. For details on using a WD Media Player to access files on your device, see Knowledge Base Answer ID 2676 or refer to your WD Media Player User Guide.

### Other Media Players

Following are general steps for setting up devices such as digital picture frames, Blu Ray players, network-connected TVs, and digital media adapters:

1. Make sure that your My Cloud EX2 Ultra device is connected to your home's local network and is powered on.
2. Follow the user instructions provided with your media player to proceed through any initial setup or installation of drivers.
3. Using the navigation feature on your player, scan and detect your My Cloud EX2 Ultra device on your network.
4. Depending on the player you have, you may need to access a Settings/Network Setup page in the user interface to establish connection so that your player can link to your My Cloud EX2 Ultra device. Please refer to your player's user guide for specific instructions.

## DLNA Devices

See specific DLNA media device user manuals for instructions on connecting a DLNA device to your local area network so you can access content on the My Cloud EX2 Ultra device. Go to <http://www.dlna.org> for a list of DLNA-certified devices and for further information.

## Accessing Your Private Cloud Using iTunes

You or anyone connected to the My Cloud EX2 Ultra device can use iTunes to play stored music files. This service creates a virtual music library on the device and treats it as an iTunes repository, making it possible to stream music files from the My Cloud EX2 Ultra device to Windows or Mac computers running iTunes. For a list of supported media types, see “Media Types Supported” on page 71.

*Note:* iTunes 10.4 or later only supports music files. See Knowledge Base Answer ID 8412 for additional information on iTunes supported versions.

*Note:* iTunes scans any shares that have the Media Serving setting enabled, including the Public share by default.

You can drag and drop media files into the corresponding folders in the Public share (e.g., music files into the MycloudEX2Ultra/Public/Shared Music default share).

## Streaming Media in iTunes

iTunes is enabled by default in the dashboard. See “Enabling iTunes” on page 74. for more information on configuring iTunes.

1. Launch iTunes on your computer.
2. Click **MyCloudEX2Ultra** under the Shared section of the left pane. If you have copied music to the /Public/Shared Music folder or a video to /Public/Shared Videos, and it is in a format supported by iTunes, it is listed in the right pane.
3. Double-click a media file you’d like to play.

## 11

# Configuring Settings

[General](#)  
[Network](#)  
[Media](#)  
[Utilities](#)  
[Notifications](#)  
[Firmware Update](#)

The Settings option on the navigation bar allows the Administrator to view and customize the My Cloud EX2 Ultra device's system, network, media, utilities, notifications, and firmware settings. This chapter explains how to configure the various settings for your My Cloud EX2 Ultra device.

## General

On the General page you can:

- View and modify the device name and description
- Select the language in which the web pages should display
- Set the date, time, and time zone for the device
- Enable cloud access for your device
- Set energy saving options
- Enable and configure Time Machine backups for your Mac
- Enable various services for your device

---

**WARNING!** Renaming the My Cloud EX2 Ultra device forces all the network computers to remap their shared network resources. Change the device name only when necessary.

---

## Accessing the General Screen

On the Navigation bar, click **Settings**. The General page displays.

The screenshot shows the 'Settings' page with the 'General' tab selected. The 'Device Profile' section includes fields for Device Name (WDMCloudL4100), Description (WDMCloudL4100), and Serial Number. Below this are sections for Language & Clock (Language: English, Time Zone: GMT-08:00 Pacific Time (US & Canada), NTP Service: ON, Primary Server: time.windows.com, Date & Time: Monday, 2015 February 09, 9:21:59 AM, Time Format: 12, Date Format: YYYY-MM-DD), Cloud Access (Cloud Service: ON, Connection Status: Connected, Port forwarding connection established, Dashboard Cloud Access: OFF), Energy Saver (Drive Sleep: ON, LED: ON, LCD: ON, Power Recovery: ON, Power Schedule: OFF, Web Access Timeout: 5 minutes), Mac Backups (Time Machine: OFF), and Services (Recycle Bin: Clear).

## Device Profile

The screenshot shows the 'Device Profile' section with the following values: Device Name: MyCloudEX2Ultra, Description: 2-Bay NAS, and Serial Number: WUBM36130026.

1. In the Device Profile section of the General page, view or modify the following settings:

Device Name	Enter a unique name for your device to identify it on the network. The device name can be up to 15 characters long and can not include special characters (e.g., @, #, \$ etc.).
Device Description	The default description is MyCloudEX2Ultra. If desired, enter a different description for your device. The device description can be up to 32 characters long and can not include special characters (e.g., @, #, \$ etc.).
Serial Number	Displays the WD-assigned number that identifies the specific unit. This field can not be updated.

- If you made any changes, click **Save** (appears next to the updated field once a change is made).

**Note:** Throughout the My Cloud EX2 Ultra dashboard, the **Apply** and **Cancel** buttons display only if you make changes.

## Language and Clock

In this section of the General screen, you can change the language that displays in the My Cloud EX2 Ultra device's interface and set the date and time. The date and time are synchronized to the NTP (Network Time Protocol) server by default. You have the option of setting the date and time manually or allowing the NTP to access the Internet and automatically set the time. If you are not connected to the Internet, you must enter the date and time manually.

- In the Language & Clock section, view or modify the following settings:

Language	From the drop-down list, select the language you'd like to display on your My Cloud EX2 Ultra Private Cloud Storage web pages. The default language is English.
Time Zone	From the drop-down list, select the time zone where your device is located.
NTP Service	Enable or disable NTP service, which automatically synchronizes your device to update the time and date. A dialog box displays current NTP servers. You can add another NTP server if you choose.
Primary Server	Change the primary server used for your NTP service. <ul style="list-style-type: none"> <li>To change the primary server used for your NTP service, click <b>Configure</b>,</li> <li>Click <b>Add User NTP</b>, and then enter the URL address of the new primary server.</li> <li>Click <b>Save</b>.</li> </ul>
Date & Time	Displays the device date and time. This information is synchronized to the NTP (network time protocol) server by default.
Time Format	From the drop-down list, select <b>12</b> (12-hour clock) or <b>24</b> (24-hour clock).

- Click **Save** for each change you make.

## Cloud Access

Use the following steps to turn cloud access on or off for all users (i.e., control whether computers and mobile devices can access the content on the My Cloud EX2 Ultra device).

**Note:** This turns on cloud access for the entire device. To turn on access for an individual user, see “Configuring Cloud Access for a User” on page 17

1. Scroll down to the Cloud Access area of the General screen.
2. In the Cloud Service field, click the toggle button  to turn on Cloud Services. The Connection Status changes to Connected (Relay connection established).
3. Click **Configure** to change the type of connection you use for your cloud access.

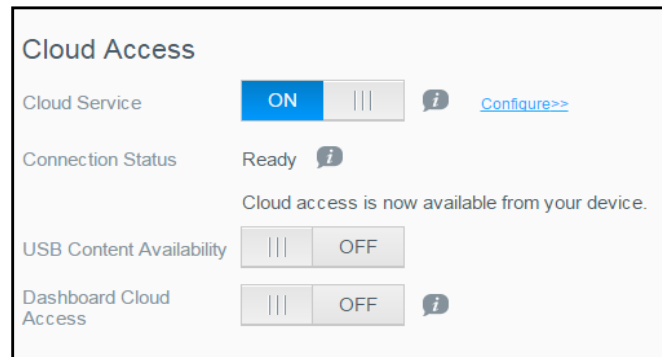

On the Cloud Access Connection Options screen, there are three access options:

- **Auto:** Auto uses uPnP to attempt to open ports on your router. If successful, a direct connection is established between your device and your apps.
- **Manual:** Establishes a connection through the two selected ports. If either port is unavailable, a relay connection is established. A manual router configuration is required for this option. See Knowledge Base Answer ID 8526 for information on how to set up your router for manual setup.
- **Win XP:** Establishes a connection through ports 80 and 443. If these ports are unavailable, a relay connection is established. This option is required if you're using Windows XP.

**Note:** By default, the My Cloud EX2 Ultra device automatically establishes a direct connection between your mobile devices and router.

4. Select a connection type:
  - **Auto:** Click **Auto**.
  - **Manual:** Click **Manual**, and then enter the External Port 1 (HTTP) and External Port 2 (HTTPS) numbers.
  - **Win XP:** Click **Win XP**.
5. Click **Apply**.
6. In the Dashboard Cloud Access field, click the toggle button  to turn on access to the dashboard from the cloud remotely.

**Note:** Selecting this option allows you to perform administrator functions remotely.

7. Review the information on the screen, and then enter and reenter a password for your administrator account. Click **Apply**.

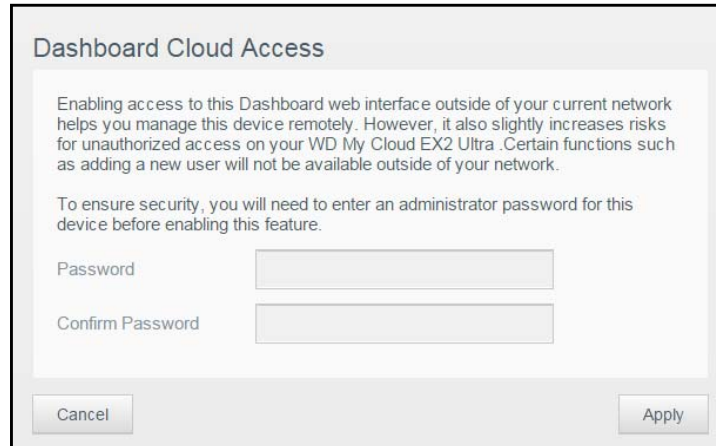

The screenshot shows a dialog box titled "Dashboard Cloud Access". The text inside reads: "Enabling access to this Dashboard web interface outside of your current network helps you manage this device remotely. However, it also slightly increases risks for unauthorized access on your WD My Cloud EX2 Ultra. Certain functions such as adding a new user will not be available outside of your network." Below this, it says: "To ensure security, you will need to enter an administrator password for this device before enabling this feature." There are two input fields: "Password" and "Confirm Password". At the bottom, there are "Cancel" and "Apply" buttons.

- If your administrator account already has a password associated with it, review the Dashboard Cloud Access screen, and then click **Apply**.

**Note:** If you set your Cloud Setting to Manual, you will have to access your device remotely using the ports you selected during the manual cloud setup.



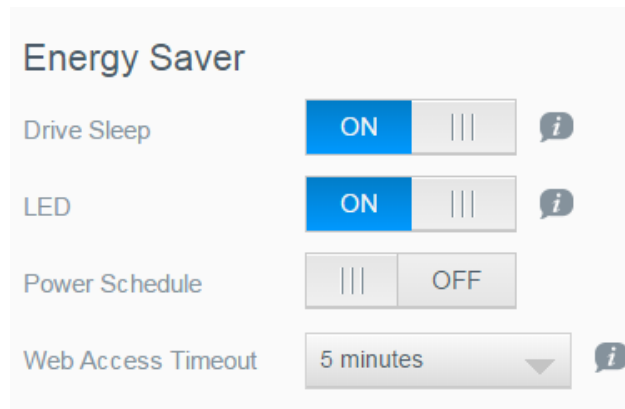

Example: If you set up your manual HTTP port as 5040, you'd use the following address to access your device: `http://<Device IP Address>:5040`.

## Energy Saver

The Energy Saver fields allow you to reduce the energy required to run your My Cloud EX2 Ultra device. Use the following information to configure the energy saving options on your My Cloud EX2 Ultra device.



View or change the following settings:

Drive Sleep	<p>Enabling this function allows the hard drives to go into standby mode to save power after a designated period of inactivity. Drive Sleep is enabled to sleep after approximately 10 minutes by default.</p> <ul style="list-style-type: none"> <li>To enable/disable Drive Sleep, click the toggle button .</li> </ul>
LED	<p>Enabling this function allows the device LEDs to go into standby mode to save power. LED is enabled by default.</p> <ul style="list-style-type: none"> <li>To enable/disable LED, click the toggle button .</li> </ul>
Power Recovery	<p>Automatically restarts your device from a previously unexpected shutdown due to power failure. Power Recovery is enabled by default.</p> <p><i>Note:</i> If you disable this feature, your device will not automatically power on after an unexpected shutdown.</p> <ul style="list-style-type: none"> <li>To enable/disable Power Recovery, click the toggle button .</li> </ul>
Power Schedule	<p>The Power Schedule allows you to schedule shutdowns for your My Cloud EX2 Ultra device.</p> <ol style="list-style-type: none"> <li>To enable Power Schedule, click the toggle button .</li> <li>Click <b>Configure</b>.</li> <li>Use the slider bar to configure the start and stop times for your device.</li> <li>Click  to send the device into hibernate.</li> <li>Click <b>Save</b>.</li> </ol>



Web Access Timeout	<p>Automatically logs you out of the system after a designated amount of time.</p> <ul style="list-style-type: none"> <li>From the Web Access Timeout drop-down menu, select an amount of time you'd like to use for your system timeout. The system updates automatically.</li> </ul>
--------------------	--

## Mac Backups

This section of the General screen enables or disables Time Machine backups of Mac computers.



**Important:** You must set a password for your Administrator account in order to restore your Time Machine backups.

### To configure backup settings:

1. In the Mac Backups area, click the toggle button  to enable Time Machine backups if not previously enabled.
2. Click the **Configure** link to display the Time Machine Settings dialog.
3. From the **Select a Share** drop-down list, select a share you'd like to use to back up your Mac data.

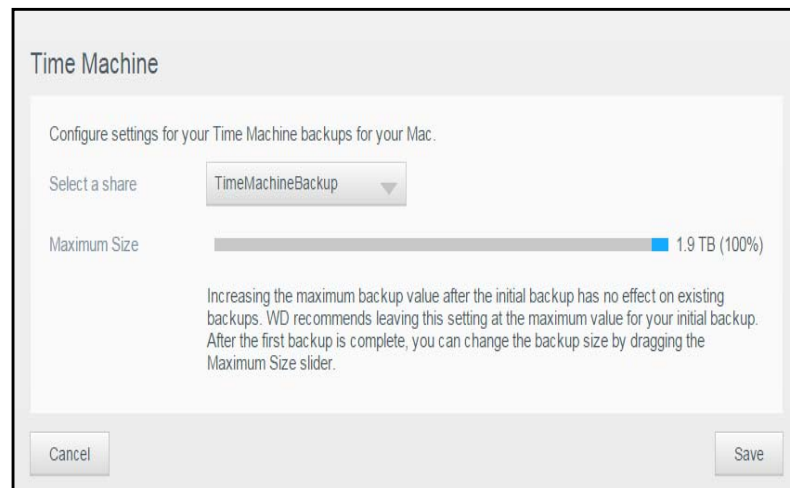

4. Click **Save**.

**Important:** Once Time Machine begins to back up your files to a selected share, we recommend that you continue to back up to that share. Switching shares generates a new backup file which will not contain your previously saved information.

## Services

This section of the General screen enables or disables various services available on your My Cloud EX2 Ultra device.

### Recycle Bin

The Recycle Bin contains any files deleted from the My Cloud EX2 Ultra device. To clear the recycle bin for your device, click **Clear**.

**Note:** Recycle Bin is only available for SMB protocols.

## Network

The **Network** screen displays the device's MAC and IP addresses and allows you to set network options such as FTP access, remote servers, and workgroups.

### Network Profile

The Network Profile section of the Network screen displays network information for the My Cloud EX2 Ultra device.



The Network Profile section displays the following information:

MAC Address	The Media Access Control (MAC) address for this device.
IPv4 IP Address	The IP version 4 address for this device.
IPv6 IP Address	The IP version 6 address for this device.

## Network Services

The Network Services section of the Network screen allows you to enable or disable the services available on your My Cloud EX2 Ultra device.

Setting	Current Value	Info Icon
IPv4 Network Mode	Static   <b>DHCP</b>	Yes
IPv6 Network Mode	Auto   DHCP   Static   <b>Off</b>	Yes
Link Aggregation	Active Backup	Yes
Link Speed	Auto	Yes
Jumbo Frame	OFF(1500)	Yes
FTP Access	OFF	Yes
AFP Service	<b>ON</b>	Yes
NFS Service	OFF	Yes
WebDAV Service	OFF	Yes
SNMP	OFF	Yes
SSH	OFF	Yes
Dynamic DNS	OFF	Yes

### 1. Review or update the following:

---

**IPv4 Network Mode** By default, the network mode is set to DHCP, which means the My Cloud EX2 Ultra device automatically gets the IP address and other settings from your network.

Select the method of assigning the device's unique IPv4 address:



- **Static:** Static IP lets you set an IP address manually. You will be prompted for IP Address, Subnet mask, Gateway IP address, and DNS Server. (If you don't know this information, please check your router settings.)
- **DHCP:** DHCP Client causes the My Cloud EX2 Ultra device to obtain an IP address and associated settings automatically from the local DHCP server.

**Note:** When configuring Static or DHCP, record your Subnet mask, Gateway IP address, and DNS Server in a safe location for future reference. This information will not be displayed once it is entered into the My Cloud EX2 Ultra server.

---

IPv6 Network Mode	<p>The IPv6 format is a new IP standard that specifies the formats of packets and the addressing scheme across multiple IP networks. By default, this option is set to OFF.</p> <p>Select the method of assigning the device's IPv6 address:</p> <ul style="list-style-type: none"> <li>• Auto</li> <li>• DHCP</li> <li>• Static</li> <li>• Off</li> </ul> <p>Once selected, complete the following fields on the associated screen, and then click <b>Save</b>:</p> <ul style="list-style-type: none"> <li>• IP Address</li> <li>• Prefix Length</li> <li>• Default Gateway</li> <li>• DNS Server</li> </ul> <p><i>Note:</i> When configuring the Static or DHCP, record your Subnet mask, Gateway IP address, and DNS Server in a safe location for future reference. This information will not be displayed once it is entered into the My Cloud EX2 Ultra server.</p>
Link Speed	<p>Select the link speed for your network from the drop-down menu, and then click <b>Save</b>. Options Include:</p> <ul style="list-style-type: none"> <li>• Auto</li> <li>• 100</li> <li>• 1000</li> </ul>
Jumbo Frames	<p>Jumbo frames are large IP frames used to increase performance over supported networks. Select the Jumbo Frame for your network from the drop-down menu, and then click <b>Save</b>.</p> <p><i>Note:</i> All devices on your network (e.g., router, computer) must support and be configured for this option in order to maximize performance.</p>
SMB2	<p>Server Message Block, version 2. Select this option to support Windows File History in Windows 8.</p> <ul style="list-style-type: none"> <li>• To enable/disable SMB2, click the toggle button .</li> </ul> <p><i>Note:</i> If you enable SMB2, read/write performance will be impacted.</p>

FTP Access	<p>File Transfer Protocol enables the transfer of data from one computer to another through a network. FTP is disabled by default.</p> <ol style="list-style-type: none"> <li>To enable FTP Access, click the toggle button to on.</li> <li>Click <b>Configure</b>.</li> <li>On the FTP Settings screen, enter the following information: <ul style="list-style-type: none"> <li><b>Maximum Users:</b> From the drop-down menu, select the maximum number of users you'd like to have FTP access.</li> <li><b>Idle Time:</b> Enter the amount of time, in minutes, you'd like the FTP to be idle before it times out.</li> <li><b>Port:</b> Enter the port to be used for FTP access.</li> <li><b>Flow Control:</b> Select either <b>Unlimited</b> or <b>Customize</b>. If you select Customize, enter a Flow Control value.</li> </ul> </li> <li>Click <b>Next</b>.</li> <li>In the <b>Passive Mode</b> field, select either <b>Default</b> or <b>Customize</b>. If you select Customize, enter Passive Mode values.</li> <li>Select the check box if you'd like to report external IP in PASV mode, and then click <b>Next</b>.</li> <li>Enter the following information: <ul style="list-style-type: none"> <li><b>Client Language:</b> Select the client language from the drop-down menu.</li> <li><b>SSL/TLS:</b> Select this check box if you'd like to allow only SSL/TLS connections.</li> <li><b>FXP:</b> To enable FXP, click the toggle button <input type="checkbox"/> to ON.</li> </ul> </li> <li>Click <b>Next</b>.</li> <li>Enter all IP addresses that you'd like to block from FTP access, and then select either <b>Permanent</b> or <b>Temporary</b> from the drop-down menu. Click <b>Save</b> to save your entries.</li> <li>Click <b>Finish</b>.</li> </ol>
AFP Service	<p>Apple File Protocol. AFP Service is automatically enabled if you are set up for Time Machine backups.</p> <ul style="list-style-type: none"> <li>To enable/disable AFP Service, click the toggle button <input type="checkbox"/>.</li> </ul> <p><b>WARNING! Mounting or ejecting a USB drive while performing an NFS or AFP file transfer will interrupt the file transfer process.</b></p>
NFS Service	<p>Network File System. Select this option to enable NFS Service for your network.</p> <ul style="list-style-type: none"> <li>To enable/disable NFS Service, click the toggle button <input type="checkbox"/>.</li> </ul> <p><b>WARNING! Mounting or ejecting a USB drive while performing an NFS or AFP file transfer will interrupt the file transfer process.</b></p>
WebDAV Service	<p>Web Distributed Authoring and Versioning (WebDAV). Select this option to enable WebDAV service for your network.</p> <ul style="list-style-type: none"> <li>To enable/disable WebDAV Service, click the toggle button <input type="checkbox"/>.</li> </ul> <p><i>Note:</i> In order to connect to the WebDAV service, use the following IP address: <code>http://&lt;server ip address&gt;:8080/Public</code></p>
LLTD	<p>Link Layer Topology Discovery protocol. Select this option to enable LLTD on your network for enhanced network discovery and diagnostics on Microsoft Windows machines.</p> <ul style="list-style-type: none"> <li>To enable/disable LLTD, click the toggle button <input type="checkbox"/>.</li> </ul>

SNMP	<p>Simple Network Management Protocol. Select this option to manage devices over IP networks.</p> <ul style="list-style-type: none"> <li>To enable/disable SNMP, click the toggle button .</li> </ul> <p><i>Note:</i> See the WD Tech Support Downloads page at <a href="http://support.wd.com">http://support.wd.com</a> to download the MiB configuration file.</p>
SSH	<p>Secured Shell protocol. Select this option to securely access your Private Cloud and perform command-line operations via the Secured Shell (SSH) protocol. SSH is disabled by default.</p> <ul style="list-style-type: none"> <li>To enable/disable SSH, click the toggle button .</li> </ul> <p><b>WARNING!</b> Please note that modifying or attempting to modify this device outside the normal operation of the product voids your WD warranty.</p> <p><i>Note:</i> The SSH login User Name is <b>sshd</b>.</p>
Dynamic DNS	<p>Select this option to host a server (Web, FTP, Game server, etc.) using a domain name.</p> <ol style="list-style-type: none"> <li>To enable/disable Dynamic DNS, click the toggle button .</li> <li>Click <b>Configure</b>.</li> <li>On the DDNS Settings screen, enter the following information: <ul style="list-style-type: none"> <li><b>Server Address:</b> Select a server address from the drop-down menu.</li> <li><b>Host Name:</b> Enter a Host Name for the server.</li> <li><b>User Name or Key:</b> Enter a User Name or Key for the server.</li> <li><b>Password or Key:</b> Enter a password or key for the server.</li> <li><b>Verify Password or Key:</b> Re-enter the password or key for the server.</li> </ul> </li> <li>Click <b>Save</b>.</li> </ol>

## Network UPS

An Uninterruptible Power Supply (UPS) is a device that works off of a battery and keeps devices that are connected to the UPS port running for at least a short time if the main power source goes out.

## Network Workgroup (Windows)

The Network Workgroup section of the Network screen allows you to enable or disable the workgroup options available on your My Cloud EX2 Ultra device.

## Workgroup

The Workgroup feature allows devices in the same workgroup to access one another. This option is only available for Windows operating systems. Each time you add a device to your network, assign it the same workgroup name to enable access.

1. In the Workgroup file, enter the name of the workgroup for your network.
2. Click **Save**.

## Local Master Browser

The Local Master Browser feature allows you to collect and record resource and/or service information across multiple locations.

- To enable/disable the Local Master Browser, click the toggle button .

## Remote Server

The Remote Server section of the Network screen allows you to enable your My Cloud EX2 Ultra device to act as a remote server, allowing you to back up shares from another My Cloud EX2 Ultra on the local LAN or WAN.



**Note:** To see your My Cloud EX2 Ultra device over the Internet, ensure that you've added port forwarding rules for both SSH and Remote Backup services ("Port Forwarding" on page 91). To enable Remote server, click the toggle button  to ON.

3. Click **Configure**.
4. In the **Password** field, enter a password to be used to access remote backups for this device to a remote server.
5. Click **Save**.
6. Review the SSH information, and then click the I accept check box.
7. Create a password for SSH login, and then click **OK**.

## Port Forwarding

The Port Forwarding section of the Network screen allows you to manage your connections to particular services by assigning default or custom port numbers.

For additional information on Port Forwarding, see *Knowledge Base Answer ID 10649*.

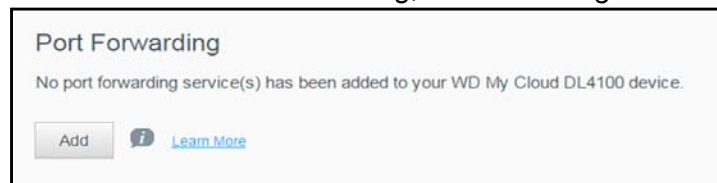

### Adding Port Forwarding Services

1. Click **Add** to add port forwarding service(s) to your My Cloud EX2 Ultra device.
2. On the Port Forwarding Settings screen, click either **Select the default service scan** or the **Customize a port forwarding service**, and then click **Next**.
  - If you selected **Select the default service scan**: Select the default service scan you'd like to use for port forwarding, and then click **Apply**.
  - If you selected **Customize a port forwarding service**, complete the following fields:
    - **Service**: Enter a service for your port forwarding.
    - **Protocol**: Select a protocol from the drop-down menu.
    - **External Port**: Enter an external port number for your port forwarding.
    - **Internal Port**: Enter the internal port number for your port forwarding
    - Click **Finish**.

### Modifying Port Forwarding Services

1. Click **Details** next to the port forwarding service you'd like to modify.
2. Make all necessary changes, and then click **Finish**.

### Deleting Port Forwarding Services

1. Click **Details** next to the port forwarding service you'd like to delete.
2. Click **Delete**. Your Port Forwarding service is deleted and removed from the Port Forwarding list.



## Media

On the Media screen, you can enter DLNA (Digital Living Network Alliance) media server and iTunes media player settings so that you can enjoy media in every room in your house.

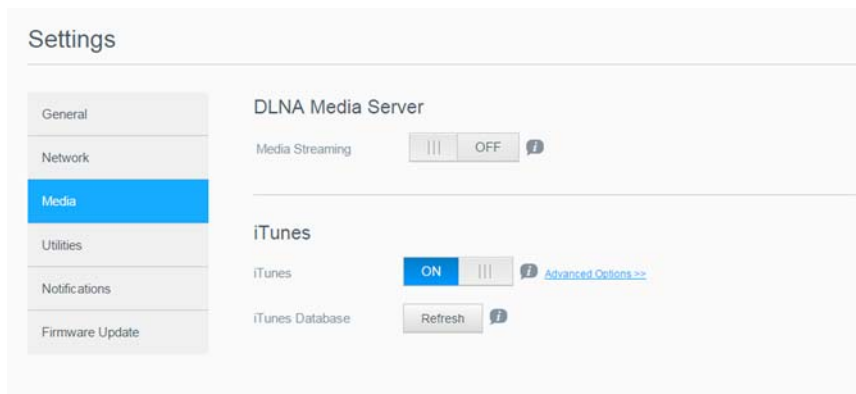

1. On the Navigation bar, click the **Settings** icon, and then click **Media** in the left panel.

*Note:* DLNA and iTunes only work on your local network.

2. For instructions on entering media settings on this page and then displaying or streaming media, see “Playing/Streaming Videos, Photos, & Music” on page 70.

## Utilities

On the Utilities page, you can test the My Cloud EX2 Ultra device and get diagnostic information, restore the device to factory defaults, reboot or hibernate the device, and import or export a configuration file.

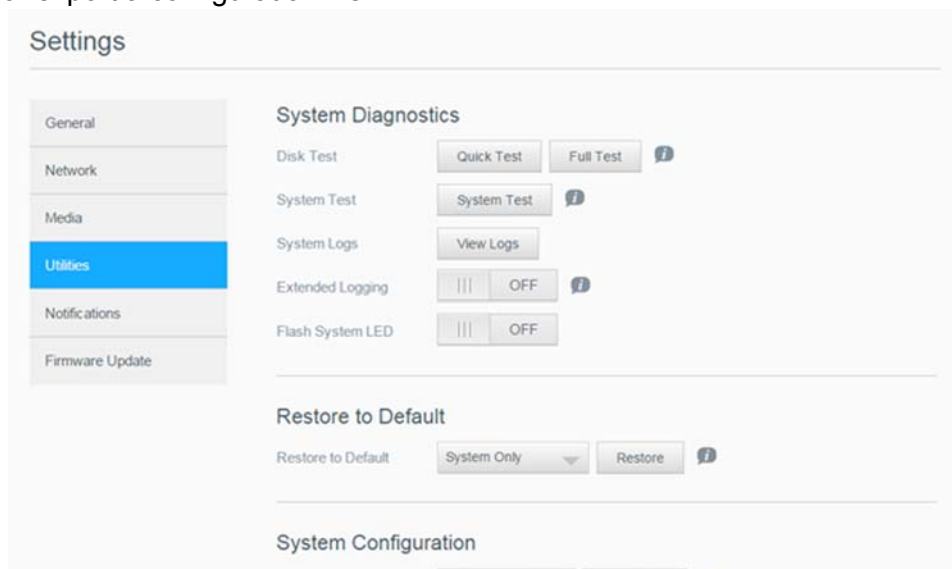

To access the Utilities screen, click the **Settings** icon, and then click **Utilities** in the left pane.

## System Diagnostics

Run diagnostic tests if you are having problems with your device. There are three types of diagnostic tests.

- **Quick Test:** The quick test checks the hard drives for major performance problems. The result of a quick test is a pass or fail evaluation of the hard drive's condition. The quick test can take several minutes to complete.
- **Full Test:** The full test is a more comprehensive drive diagnostic. It methodically tests each and every sector of the hard drives. You will be informed of the condition of the hard drive once the test is performed. The full test may take hours to complete, depending on the size and data configuration of the hard drives.
- **System Test:** The system test reviews the health of your device hardware (hard drives, fan, system clock, and device temperature).

### Running a Diagnostic Test

1. On the Utilities page, click **Quick Test**, **Full Test**, or **System Test**. A progress bar displays, indicating test progress and whether the device passed or failed the test.
2. Review the test results, and then click **Close**.
  - If the device fails the test, click , and then click **Support** to get assistance.

### System Restore

The system restore allows the Administrator to perform a full factory restore on the My Cloud EX2 Ultra device. This option restores your device to factory default settings with no data loss.

---

**Important:** Before doing a factory restore or a system update, you may choose to save your device's current configuration. At a later time, you can import a previously saved configuration. Keep in mind that importing a configuration after restoring factory defaults does not restore shares or users. See "System Configuration," to create or restore a configuration file.

---

*Note:* To erase all of the data on your device, see "Format Disk" on page 95.

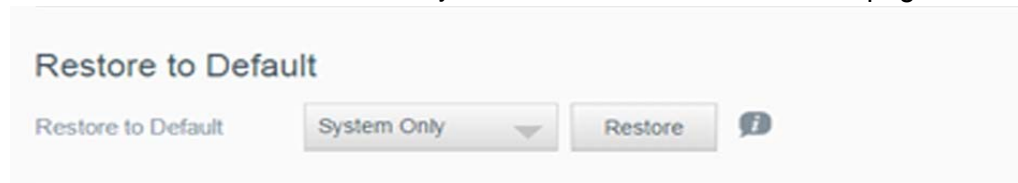

1. In the System Restore area, click **System Restore**.
2. Review the confirmation message, and then click **OK**.

The device reboots. Don't unplug the device during this rebooting process. Once the reboot is complete, launch the dashboard.

### System Configuration

The system configuration area allows you to save a configuration file or import an existing configuration file. This is useful if you perform a system restore and want to maintain your current configurations.

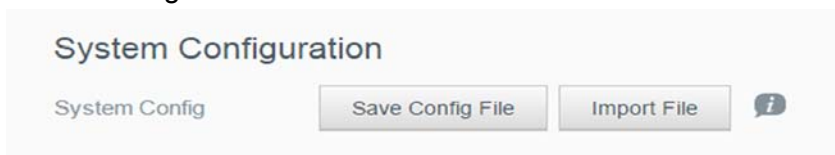

## Saving a Configuration File

Use the following steps to save a configuration file.

1. In the System Configuration area, click **Save Config File**.
2. The configuration file saves to your desktop.

## Importing a Configuration File

Use the following steps to save a configuration file.

1. In the System Configuration area, click **Import File**.
2. Navigate to the location of your saved configuration file and select it. The configuration file is loaded. The device will reboot. Don't unplug the device during this rebooting process. Once the reboot is complete, launch the dashboard.

## Device Maintenance

The Device Maintenance area allows you to reboot or hibernate your My Cloud EX2 Ultra device. This area also displays the amount of time the device has been up and running.

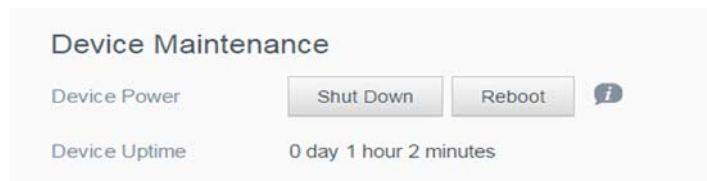

### Setting Device to Hibernate

Use the following steps to safely set your My Cloud EX2 Ultra device to hibernate.

1. In the top menu, click **Settings**.
2. In the left menu, click **Utilities**.
3. In the Device Maintenance area, click **Hibernate**.
4. Review the confirmation message, and then click **OK**. Your My Cloud EX2 Ultra safely shuts down.

### Rebooting the Device

1. In the top menu, click **Settings**.
2. In the left menu, click **Utilities**.
3. In the Device Maintenance area, click **Reboot**.
4. Review the confirmation message, and then click **OK**. Your My Cloud EX2 Ultra safely reboots.

## Scan Disk

The Scan Disk area allows you to scan your device's hard disks for any errors.



### Scanning Your Disk

Use the following steps to run a disk scan on your My Cloud EX2 Ultra device.

1. In the Scan Disk area, select the volume you'd like to scan from the drop-down menu.
2. Click **Scan Disk**.
3. Review the confirmation message, and then click **OK**. Your My Cloud EX2 Ultra is scanned for disk errors.

## Format Disk

The Format Disk area allows you to format your device's hard disks.

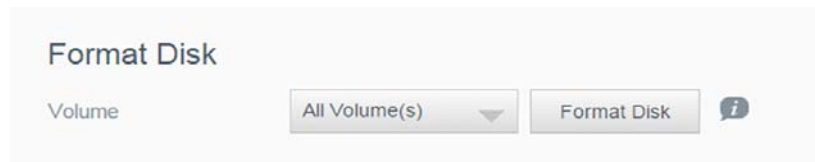

---

**WARNING!** The **Format Disk** option erases all of the user data and shares permanently, retaining default shares. Data recovery programs cannot be used to restore data; all user data and shares are permanently deleted.

**Formatting your disk will take several hours to complete.**

---

## Formatting Your Disk

Use the following steps to format the disks on your My Cloud EX2 Ultra device.

1. In the Format Disk area, select the volume you'd like to format from the drop-down menu.
2. Click **Format Disk**.
3. Review the confirmation message, select the check box, and then click **OK**. Your My Cloud EX2 Ultra is formatted.

## Notifications

The My Cloud EX2 Ultra device provides notifications about various events, such as firmware updates, the success of firmware installations, and system shutdowns. Notifications display in the Alert area at the top of the screen and are also available by email, depending on how your device is configured (for additional information on Alerts, see “Managing Alerts” on page 33).

The Notification section of the page allows you to set up email addresses for up to five users who will receive notifications, set up SMS alert messages for mobile devices, and set the level of alert for which you will be notified.

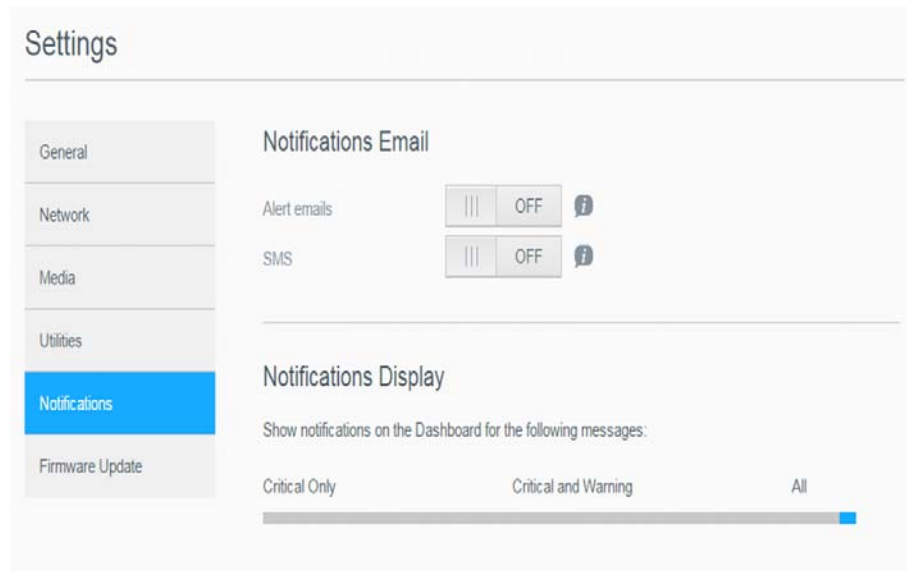

## Notifications Email

The Notification Email area allows you to set up email alerts and SMS notifications for specified users.



### Enabling Email Alerts

1. On the Navigation bar, click the **Settings** icon, and then click **Notifications** on the left pane.
2. To enable Alert emails, click the toggle button  to on.
3. Click **Configure**.
4. On the Alert Notification screen, use the slider bar to select the level of alerts you'd like to receive by email.
  - **Critical Only:** Send only critical alerts to the specified email address.
  - **Critical and Warning:** Send both critical and warning alerts to the specified email address.
  - **All:** Send all alerts (Informational, Critical, Warning) to the specified email address.
5. Click **New Email**.
6. Enter the email address where you'd like to receive alert emails, and then click **Apply**.
7. Repeat steps 5 - 6 to enter up to 5 email addresses.
8. Click **Send Test Email** to validate the email addresses you entered.
9. Click **OK**, and then check your email for a validation email.

## Enabling SMS Notifications

**Note:** Check with your SMS service provider to obtain their requirements for sending SMS messages. Certain carriers may require you to send SMS/text messages by email.

1. On the Navigation bar, click the **Settings** icon, and then click **Notifications** from the left pane.
2. To enable SMS, click the toggle button .
3. Click **Configure**.
4. On the SMS Settings screen, enter the name of your SMS provider.
5. Enter the SMS URL with the message content set to be “Hello world”

*Note:* This SMS URL is used only for setup. No SMS message will be sent after setup is completed. Obtain the URL format requirements from your SMS service provider. They should contain the following parameters: username, password, destination phone, and message content.

6. Click **Next**.
7. Select the corresponding category for each SMS parameter from the drop-down menu.
8. Click **Finish**. Your SMS notification is now set up.

## Notification Display

The Notification Display allows you to select the type of notifications that are sent to you.



1. On the Notification Display screen, using the slider bar, select the level of notifications you'd like to view.
  - **Critical Only:** Send only critical alerts.
  - **Critical and Warning:** Send both critical and warning alerts.
  - **All:** Send all alerts (Informational, Critical, Warning).

The system automatically updates with your selection.

## Firmware Update

The Firmware Update page allows you to set up the device to update the My Cloud EX2 Ultra firmware automatically or to manually check for an update file. The current version number and the date of last update of the firmware also display on this screen.

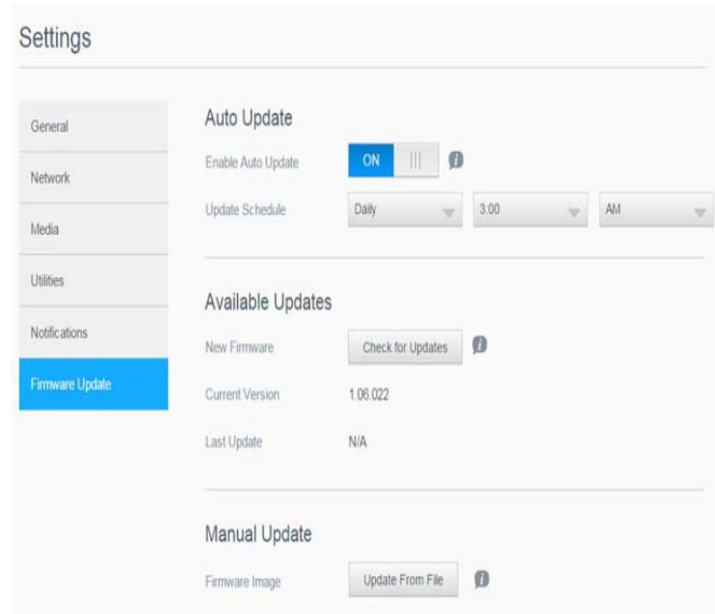

## Auto Update

Auto Update allows you to schedule your My Cloud EX2 Ultra device to conveniently check for available software updates and install them automatically. This is the easiest way of ensuring the My Cloud EX2 Ultra firmware is current.

**Note:** After a firmware update installs, the My Cloud EX2 Ultra device reboots. Since a reboot affects users' ability to access the cloud, schedule the updates to occur at times when the likelihood of users accessing the cloud are minimal. If you enable Auto Update, you are asked to manually reboot your system when the update is complete.

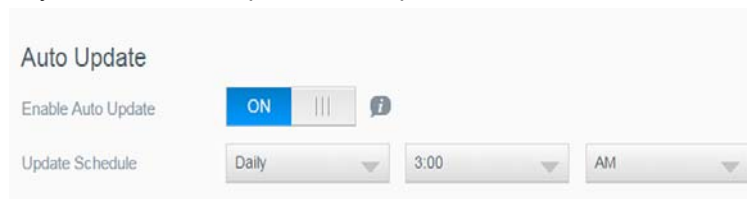

## Updating Firmware Automatically

1. To enable Auto Update, click the toggle button  to ON.
2. In the Update Schedule field, from the drop-down lists, specify the frequency (e.g., daily) and the time at which the device should look for an update on the WD website.
3. Click **Apply**.

Once saved, your device will check for firmware updates at the specified time and day. If an update is available, it will automatically install and prompt you for a reboot.

## Available Updates

You can check for available updates at any time in the Available Updates area. This area also displays the current version of the firmware and indicates when the last firmware update was made.

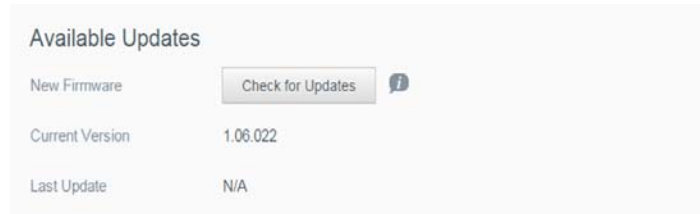

### Checking for Updates

1. In the New Firmware field, click **Check for Updates**.
2. Review the Update Firmware screen and click **OK**.
  - If an update is available, click **Install and Reboot**.

## Manual Update

Follow this procedure to perform a manual update.

*Note:* Ensure that you've downloaded the firmware file you need to install on your device from the WD Tech Support Downloads page at <http://support.wd.com/product/download.asp>.

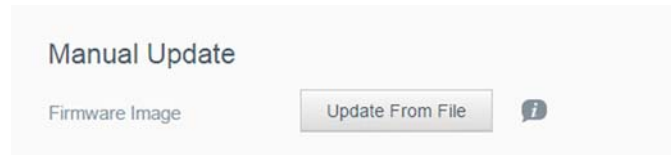

### Manually Installing an Update

1. In the Manual Update section, click **Update from File**.
2. Navigate to the firmware update file, and then click **Open**.
3. Review the confirmation message, and then click **OK**.  
The update installs on your device. When the update is complete, your My Cloud EX2 Ultra device reboots.



## 12

# Replacing a Drive

[Identifying a Faulty Hard Drive](#)  
[Replacing a Drive](#)  
[Returning a WD Drive](#)

The My Cloud EX2 Ultra device is a limited user-serviceable product that allows you to replace the hard drives in the enclosure. You can use WD hard drives or another brand's hard drive.

*Note:* For a complete list of compatible drives, visit [wd.com/mycloudex2Ultra](http://wd.com/mycloudex2Ultra)

---

**Important:** For best performance, WD recommends inserting WD Red™ hard drive assemblies into the unit's enclosure. Visit [support.wdc.com](http://support.wdc.com) and search the knowledge base for Knowledge Base Answer ID 8 to get detailed instructions on obtaining a replacement drive for this product.

---

Following are instructions for replacing a faulty drive or, if your My Cloud EX2 Ultra model did not come with drives, for inserting drives.

## Identifying a Faulty Hard Drive

If the LEDs on the unit are flashing or you have received an alert, a hard drive may be faulty. To determine which drive is faulty, do the following:

1. On the dashboard's navigation panel, click **Storage**, and then click **Disk Status**.

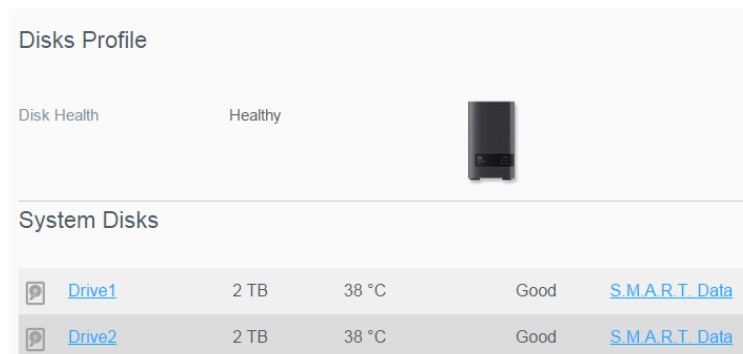

2. If one of the drives is Bad or has Failed, select it and view detailed information on the Hard Drive Information dialog box:

*Note:* The drive number corresponds to the 1 or 2 decal on the drive.

In the event a fault occurs, and you would like to service the device yourself, visit WD Technical Support at [support.wdc.com](http://support.wdc.com) and search for Knowledge Base Answer ID 8 to obtain detailed instructions on obtaining a replacement drive. When contacting Technical Support, have the following information ready: the My Cloud EX2 Ultra device's serial number, date of purchase, and the serial number of the internal hard drive(s) requiring replacement.

## Replacing a Drive

If you bought a My Cloud EX2 Ultra device without hard drives, or if you are replacing an existing drive, you may use a drive made by another company. For a list of compatible drives, go to [support.wdc.com](http://support.wdc.com).

---

**Important:** If you are adding two 8TB capacity and above HDD, the 36W power adapter should be replaced with a 48W power adapter. To purchase, visit [store.wdc.com](http://store.wdc.com).

---

## Removing a Drive

---

**Important:** Before getting started, power off the unit and disconnect all of its cables. Place the unit on a clean and stable surface.

---

If the My Cloud EX2 Ultra still contains the faulty (drive) you must first remove it before you can insert the new one.

1. Reveal the hard drives by pressing the indented button on the top of the device and pulling up the door.
2. Remove the bracket used for holding drives in.
3. Pull the plastic tab at the back of the drive and with your other hand, guide the drive up and out of the enclosure.

## Inserting a Drive

---

**Important:** To avoid electrostatic discharge (ESD) problems, ground yourself by touching metal before handling the device.

---

## Preparing a Drive

The My Cloud EX2 Ultra comes with a bag holding the screws, tabs, and labels needed for inserting the new drive. For WD replacement drives, you can reuse the parts attached to the faulty drive.

*Note:* A standard phillips-head screwdriver is all you need.

1. Using a screw from the bag, attach a plastic tab to the top hole in the drive's side (on the right if the green board is facing you).
2. Attach a screw to the corresponding hole on the other side of the drive.
3. Attach label 1 or 2 to the top of the drive. Label 1 is on the left and label 2 is on the right, when looking down on the top of the unit. There are corresponding numbers on the cross brace label.

## Inserting One or Both Drives

1. Press the indent on the top of the unit to open the door, and then remove the bracket that holds the drives in.
2. When looking down on the top of the unit with the front panel towards you, if you are inserting two drives, arrange them so that the connectors at the bottom face in. (The

- green boards should face each other.) If inserting one drive, the green board faces the middle of the unit.
3. Gently slip a drive into the slot. Make sure the plastic tab is sticking up at the back of the unit. Repeat with the other drive, if applicable.
  4. Screw the bracket over the tops of the drives. Close the door and firmly push down until it locks into place.
  5. Reconnect the network and power cables to the device.

*Note:* For information about rebuilding the replacement drive, visit <http://support.wdc.com> and search the knowledge base for Knowledge Base Answer ID 11007,

---

**Important:** Do not attempt to use the device during the rebuild process.

---

## Returning a WD Drive

---

**Important:** Do not disassemble the internal drive and attached assembly components. Return the entire internal drive assembly intact to WD.

---

Return the faulty drive following the instructions provided in the WD Knowledge Base Answer ID 8.

## 13

# Regulatory and Warranty Information

Regulatory Compliance

Warranty Information (All Regions Except Australia/New Zealand)

Warranty Information (Australia/New Zealand only)

## Regulatory Compliance

### Federal Communications Commission (FCC) Class B Information

Operation of this device is subject to the following two conditions:

1. This device may not cause harmful interference.
2. This device must accept any interference received, including interference that may cause undesired operation.

Changes or modifications not expressly approved by the party responsible for compliance could void the user's authority to operate the equipment.

### FCC Requirements, Part 15

This equipment has been tested and found to comply with the limits for a Class B digital device pursuant to Part 15 of the FCC Rules. These limits are designed to provide reasonable protection against harmful interference in a residential installation. This equipment generates, uses, and can radiate radio frequency energy and, if not installed and used in accordance with the manufacturer's instruction manual, may cause interference with radio communications. However, there is no guarantee that interference will not occur in a particular installation. If this equipment does cause harmful interference to radio or television reception, which can be determined by turning the equipment off and on, you are encouraged to try to correct the interference by one or more of the following measures:

- Reorient or relocate the receiving antenna.
- Increase the separation between the equipment and the receiver.
- Connect the equipment into an outlet on a circuit different from that to which the receiver is connected.
- Consult the retailer or an experienced radio/television technician for help.

Any changes or modifications not expressly approved by WD could void the user's authority to operate the equipment.

### ICES/NMB-003 Compliance

Cet appareil DE la classe B est conform à la norm NMB-003 dew Canada.

This device complies with Canadian ICES-003 Class B.

### Safety Compliance

Approved for US and Canada. CAN/CSA-C22.2 No. 60950-1, UL 60950-1: Safety of Information Technology Equipment.

Approuver pour els Etas-Units et el Canada. CAN/CSA-C22.2 No. 60950-1: Secret equipment DE technologie de l'information.

This product is intended to be supplied by a listed limited power source, double insulated, or direct plug-in power unit marked "Class 2."

### CE Compliance for Europe

Verified to comply with EN55022 for RF emission; EN-55024 for Generic Immunity, as applicable; and EN-60950 for Safety.

### GS Mark (Germany only)

Machine noise - regulation 3. GPSGV: Unless declared otherwise, the highest level of sound pressure from this product is 70db(A) or less, per EN ISO 7779. Maschinenlärminformations-Verordnung 3. GPSGV: Der

höchste Schalldruckpegel beträgt 70 db(A) oder weniger gemäß EN ISO 7779, falls nicht anders gekennzeichnet oder spezifiziert.

## KC Notice (Republic of Korea only)

기종별	사용자 안내문
B 급기기 (가정용방송통신기자재)	이 기기는 가정용(B 급) 전자파적합기기로서 주로 가정에서 사용하는 것을 목적으로 하며, 모든 지역에서 사용할 수 있습니다.

Class B Device Please note that this device has been approved for non-business purposes and may be used in any environment, including residential areas.

Korean KCC certification ID: MSIP-REM-WDT-D8C

## VCCI Statement

この装置は、クラスB情報技術装置です。この装置は、家庭環境で使用することを目的としていますが、この装置がラジオやテレビジョン受信機に近接して使用されると、受信障害を引き起こすことがあります。

取扱説明書に従って正しい取り扱いをして下さい。

VCCI-B

## Environmental Compliance (China)

部件编号	铅 (Pb)	Mercury (Hg)	Cadmium (Cd)	六价铬 (Cr (VI))	多溴联苯(PBB)	多溴联苯醚(PBDE)
PCBA	X	○	○	○	○	○
适配器主体	X	○	○	○	○	○
电缆	○	○	○	○	○	○
螺丝	○	○	○	○	○	○
脚垫	○	○	○	○	○	○
金属	○	○	○	○	○	○
塑料	○	○	○	○	○	○
木箱	○	○	○	○	○	○
标签	○	○	○	○	○	○

○：表示元件构成同种材料不含有杂质或所含杂质符合 SJ/T 11363-2006 规范所规定的最大允许掺杂范围。

X：表示元件所含物质超出 SJ/T 11363-2006 规范

## Warranty Information (All Regions Except Australia/New Zealand)

### Obtaining Service

WD values your business and always attempts to provide you the very best of service. If this Product requires maintenance, either contact the dealer from whom you originally purchased the Product or visit our product support Web site at <http://support.wd.com> for information on how to obtain service or a Return Material Authorization (RMA). If it is determined that the Product may be defective, you will be given an RMA number and instructions for Product return. An unauthorized return (i.e., one for which an RMA number has not been issued) will be returned to you at your expense. Authorized returns must be shipped in an approved shipping container, prepaid and insured, to the address provided on your return paperwork. Your original box and packaging materials should be kept for storing or shipping your WD product. To conclusively establish the period of warranty, check the warranty expiration (serial number required) via <http://support.wd.com>. WD shall have no liability for lost data regardless of the cause, recovery of lost data, or data contained in any Product placed in its possession.

### Limited Warranty

WD warrants that the Product, in the course of its normal use, will for the term defined below, be free from defects in material and workmanship and will conform to WD's specification therefor. The term of your limited

warranty depends on the country in which your Product was purchased. If the Product you purchased is a 2-Bay or 4-Bay Product that is pre-populated with WD hard disk drives preinstalled, the term of your limited warranty for such Product shall be 3 years in the North, South, and Central America region, 3 years in the Europe, the Middle East, and Africa region, and 3 years in the Asia Pacific region, unless otherwise required by law. If the Product you purchased is a 1-Bay Product that is prepopulated with a WD hard disk drive pre-installed or comes bare (i.e. it does not have any WD hard disk drives preinstalled by WD), the term of your limited warranty for such Product shall be 2 years in the North, South, and Central America region, 2 years in the Europe, the Middle East, and Africa region, and 2 years in the Asia Pacific region, unless otherwise required by law. The term of your limited warranty period shall commence on the purchase date appearing on your purchase receipt. WD may at its discretion make extended warranties available for purchase. WD shall have no liability for any Product returned if WD determines that the Product was stolen from WD or that the asserted defect a) is not present, b) cannot reasonably be rectified because of damage occurring before WD receives the Product, or c) is attributable to misuse, improper installation, alteration (including removing or obliterating labels and opening or removing external enclosures, including the mounting frame, unless the product is on the list of limited user-serviceable products and the specific alteration is within the scope of the applicable instructions, as found at <http://support.wd.com>), accident or mishandling while in the possession of someone other than WD. Subject to the limitations specified above, your sole and exclusive warranty shall be, during the period of warranty specified above and at WD's option, the repair or replacement of the Product with an equivalent or better Product. The foregoing warranty of WD shall extend to repaired or replaced Products for the balance of the applicable period of the original warranty or ninety (90) days from the date of shipment of a repaired or replaced Product, whichever is longer.

The foregoing limited warranty is WD's sole warranty and is applicable only to products sold as new. The remedies provided herein are in lieu of a) any and all other remedies and warranties, whether expressed, implied or statutory, including but not limited to, any implied warranty of merchantability or fitness for a particular purpose, and b) any and all obligations and liabilities of WD for damages including, but not limited to accidental, consequential, or special damages, or any financial loss, lost profits or expenses, or lost data arising out of or in connection with the purchase, use, or performance of the Product, even if WD has been advised of the possibility of such damages. In the United States, some states do not allow exclusion or limitations of incidental or consequential damages, so the limitations above may not apply to you. This warranty gives you specific legal rights, and you may also have other rights which vary from state to state.

## Warranty Information (Australia/New Zealand only)

**For consumers purchasing products in Australia and New Zealand, please refer to this warranty information.**

Nothing in this warranty modifies or excludes your legal rights under the Australian Competition and Consumer Act or the New Zealand Consumer Guarantees Act. This warranty identifies WD's preferred approach to resolving warranty claims which is likely to be quick and simple for all parties.

No other warranties either express or implied by law, including but not limited to those contained in the Sale of Goods Act, are made with respect to the Product. If you purchased your Product in New Zealand for the purposes of a business, you acknowledge and agree that the New Zealand Consumer Guarantees Act does not apply.

In Australia, our goods come with guarantees that cannot be excluded under the Australian Consumer Law. You are entitled to a replacement or refund for a major failure and compensation for any other reasonably foreseeable loss or damage. You are also entitled to have the goods repaired or replaced if goods fail to be of acceptable quality and the failure does not amount to a major failure. What constitutes a major failure is set out in the Australian Consumer Law.

## Warranty

WD warrants that the Product, in the course of its normal use, will for the period defined below be free from defects in material and workmanship and will conform to WD's specifications. If the Product you purchased is a 2-Bay or 4-Bay Product that is prepopulated with WD hard disk drives preinstalled, the term of your limited warranty for such Product shall be 3 years in the North, South, and Central America region, 3 years in the Europe, the Middle East, and Africa region, and 3 years in the Asia Pacific region, unless otherwise required by law. If the Product you purchased is a 1-Bay Product that is prepopulated with a WD hard disk drive pre-installed or comes bare (i.e. it does not have any WD hard disk drives preinstalled by WD), the term of your limited warranty for such Product shall be 2 years in the North, South, and Central America region, 2 years in the Europe, the Middle East, and Africa region, and 2 years in the Asia Pacific region, unless otherwise required by law. The term of your warranty period shall commence on the purchase date appearing on your purchase receipt from an authorized distributor or authorized reseller. Proof of purchase shall be required to be eligible for this warranty and to establish the commencement date of this warranty. Warranty service will not be provided unless the Product is returned to an authorized distributor, authorized reseller or regional WD return center where the Product was first shipped by WD. WD may at its discretion make extended warranties available for purchase. WD shall have no liability for any Product returned if WD determines that the Product was (i) not purchased from an authorized distributor or authorized reseller, (ii) not used in accordance with WD specifications and instructions, (iii) not used for its intended function, or (iv) stolen from WD, or that the asserted defect a) is not present, b) cannot reasonably be rectified because of damage occurring before WD receives the Product, or c) is attributable to misuse, improper installation, alteration (including removing or obliterating labels and opening or removing external enclosures, including the mounting frame, unless the product is on the list of limited user-serviceable products and the specific alteration is within the scope of the

applicable instructions, as found at <http://support.wd.com>, accident or mishandling while in the possession of someone other than WD.

**PRODUCTS ARE COMPLEX AND FRAGILE ITEMS THAT MAY OCCASSIONALLY FAIL DUE TO (A) EXTERNAL CAUSES, INCLUDING WITHOUT LIMITATION, MISHANDLING, EXPOSURE TO HEAT, COLD, AND HUMIDITY, AND POWER FAILURES, OR (B) INTERNAL FAULTS. SUCH FAILURES CAN RESULT IN THE LOSS, CORRUPTION, DELETION OR ALTERATION OF DATA. NOTE THAT YOU SHALL BE RESPONSIBLE FOR THE LOSS, CORRUPTION, DELETION OR ALTERATION OF DATA HOWSOEVER CAUSED, AND FOR BACKING UP AND PROTECTING DATA AGAINST LOSS, CORRUPTION, DELETION OR ALTERATION. YOU AGREE TO CONTINUALLY BACK UP ALL DATA ON THE PRODUCT, AND TO COMPLETE A BACKUP PRIOR TO SEEKING ANY GENERAL SERVICE AND TECHNICAL SUPPORT FROM WD.**

In Australia, if the Product is not of a kind ordinarily acquired for personal, domestic or household use or consumption, provided it is fair and reasonable to do so, WD limits its liability to replacement of the Product or supply of equivalent or better Product.

This warranty shall extend to repaired or replaced Products for the balance of the applicable period of the original warranty or ninety (90) days from the date of shipment of a repaired or replaced Product, whichever is longer. This warranty is WD's sole manufacturer's warranty and is applicable only to Products sold as new.

## Obtaining Service

WD values your business and always attempts to provide you the very best of service. Should you encounter any problem, please give us an opportunity to address it before returning this Product. Most technical support questions can be answered through our knowledge base or email support service at <http://support.wd.com>. If the answer is not available or, if you prefer, please contact WD at the applicable telephone number shown in the front of this document.

If you wish to make a claim, you should initially contact the dealer from whom you originally purchased the Product. If you are unable to contact the dealer from whom you originally purchased the Product, please visit our product support Web site at <http://support.wd.com> for information on how to obtain service or a Return Material Authorization (RMA). If it is determined that the Product may be defective, you will be given an RMA number and instructions for Product return. An unauthorized return (i.e., one for which an RMA number has not been issued) will be returned to you at your expense. Authorized returns must be shipped in an approved shipping container, prepaid and insured, to the address provided with your RMA number. If following receipt of a qualifying claim under this warranty, WD or the dealer from whom you originally purchased the Product determines that your claim is valid, WD or such dealer shall, at its discretion, either repair or replace the Product with an equivalent or better Product or refund the cost of the Product to you. You are responsible for any expenses associated with a claim under this warranty. The benefits provided to you under this warranty are in addition to other rights and remedies available to you under the Australian Competition and Consumer Act or the New Zealand Consumer Guarantees Act.

Your original box and packaging materials should be kept for storing or shipping your WD product. To conclusively establish the period of warranty, check the warranty expiration (serial number required) via <http://support.wd.com>.

Western Digital Technologies, Inc.  
3355 Michelson Drive, Suite 100  
Irvine, California 92612  
Phone: 949-672-7000  
Email: [support@wd.com](mailto:support@wd.com)

## 12

## Appendices

[Appendix A: My Cloud EX2 Ultra Quick User Guide](#)

[Appendix B: Joomla!® Setup Guide](#)

[Appendix C: phpBB Setup Guide](#)

[Appendix D: Supported RAID Modes](#)

[Appendix E: RAID Migrations](#)

[Appendix F: Safe Mode Firmware Update Procedures](#)

Once your device has completed the reboot, we recommend that you do a system restore (“System Restore” on page 93).

### Appendix A: My Cloud EX2 Ultra Quick User Guide

This guide is primarily for My Cloud EX2 Ultra users, rather than the administrator.

#### Logging into My Cloud EX2 Ultra

1. Enter the name of your My Cloud EX2 Ultra device (default name: MyCloudEX2Ultra) in the browser’s address field:
  - **http://<device name>** (Windows) (Example: http://MyCloudEX2Ultra)
  - **https://<device name>.local** (Mac) (Example: https://MyCloudEX2Ultra.local)
2. Click **Go**.

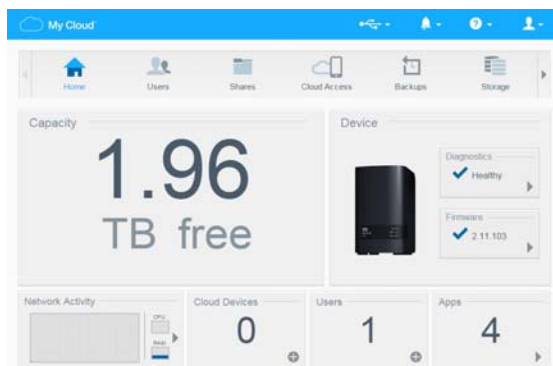

3. On the My Cloud EX2 Ultra Login page, enter your User name and Password.
4. Click **Login**. The My Cloud EX2 Ultra dashboard displays.



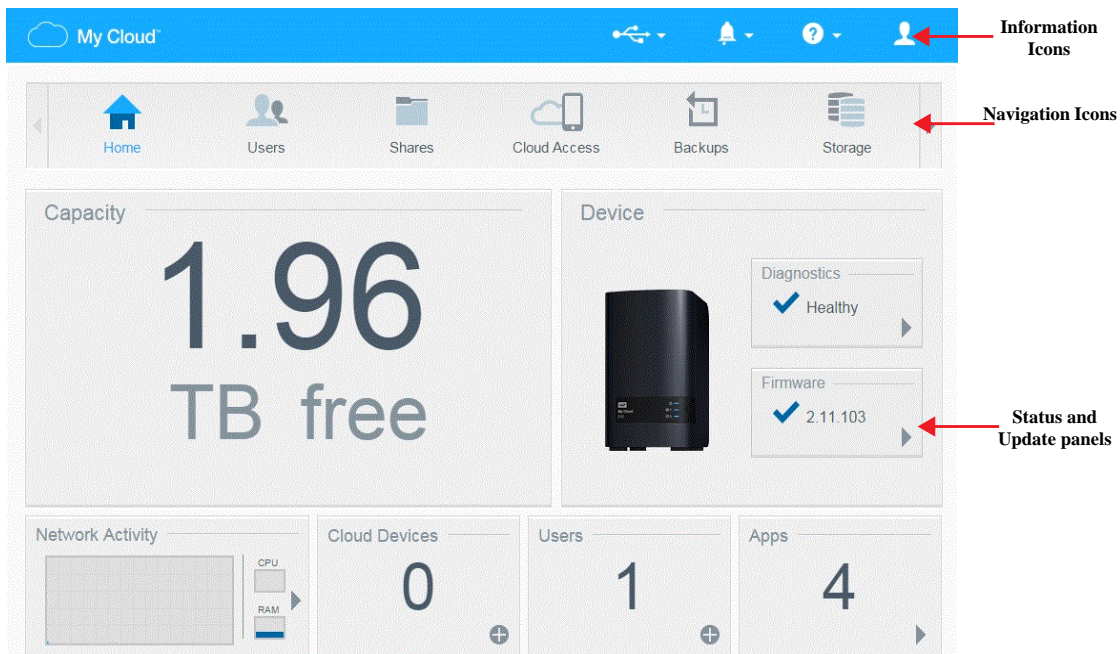

## The Dashboard Home Page

The My Cloud EX2 Ultra Home page has an information bar at the top right, a navigation icon bar across the page, an instant overview of the status of the device's main functions and links for updating settings.

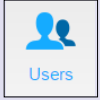
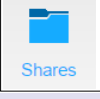

### Navigation Icons

Icon	Name	Actions
	Home	The dashboard displays an instant overview of the status of the device's main functions and links for updating settings.
	Users	Create, change, and delete users and grant them full or limited access to particular shares.
	Shares	Create, change, and delete shares (folders) and grant specific users full, limited, or no access to particular shares.
	Cloud Access	Set up, change, and remove remote cloud access to particular shares. Monitor remote access status.
	Backups	Create backups to: <ul style="list-style-type: none"> <li>• A USB drive</li> <li>• Another My Cloud EX2 Ultra or a My Cloud device on your local network or on a remote network</li> <li>• A Cloud backup site</li> </ul>

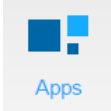
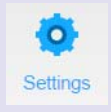
Icon	Name	Actions
	Storage	Select the way your My Cloud EX2 Ultra device stores your data.
	Apps	Add or remove various apps that allow you to use your device more productively.
	Settings	Customize settings for: <ul style="list-style-type: none"> <li>• Language &amp; Clock</li> <li>• Network services</li> <li>• Media sharing</li> <li>• Firmware downloads</li> </ul>

### Viewing the Home Page

The Home is your gateway to the My Cloud EX2 Ultra device. From this page you can find:

- The capacity of the device
- Quick status and links to download information
- Links to desktop and mobile apps
- Built-in apps to make your device more productive

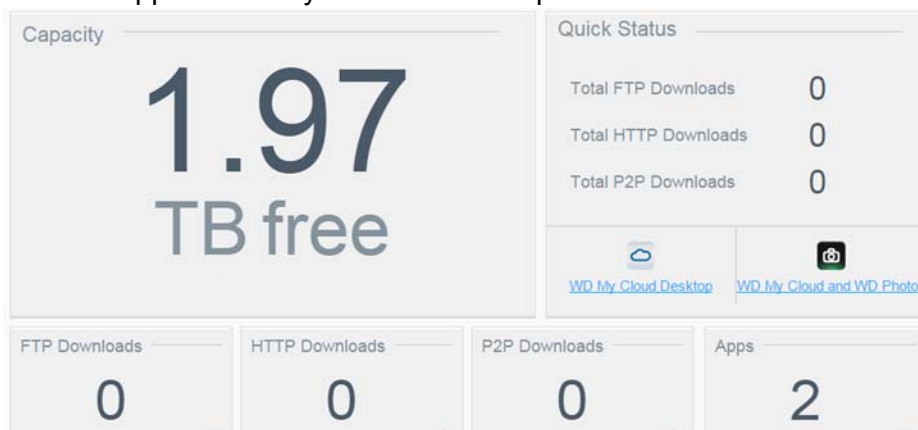

### Capacity

The Capacity panel displays the amount of free storage left on your My Cloud EX2 Ultra device.

1. To see detailed information, click the arrow in the lower right to display the current usage of the drive's capacity:



2. To return to the Home page, click **Close**.

### Quick Status

The Quick Status area displays the total number of FTP, HTTP, and P2P downloads performed.



### Cloud Access Links

The Cloud Access Links allow you to access the software necessary to gain access to the My Cloud EX2 device from your desktop and mobile apps.

### Downloads and Apps Information

The Downloads and Applications area displays information on the number of downloads and apps available on your device.

- To access the page associated with each download and applications page, click the plus sign .

## Downloads

The Downloads page allows you to download files using the following methods:

- HTTP (Hypertext Transfer Protocol)
- FTP (File Transfer Protocol)
- P2P (Peer-to-Peer)

1. In the left pane, click a download method.
2. To download files to your location, enter the information required for each download method.

## Apps

The Apps page provides access to the various apps available for your use on the My Cloud EX2 Ultra device. Available apps vary depending on what your administrator has implemented.

## Appendix B: Joomla!® Setup Guide

Joomla! is an award-winning content management system (CMS) that allows you to build Web sites and powerful online apps. For additional information on Joomla!, visit <http://www.joomla.org/>

Joomla! is one of the many apps available for use from your My Cloud EX2 Ultra device. Provided in this section are the steps you'll need to set up Joomla!.

### Requirements

- Database (e.g., MySQL, FireBird, MS SQL server, Oracle, PostgreSQL, SQLite)
- If you're using phpMyAdmin as your SQL database, ensure that you've added the phpMyAdmin app to you My WD Cloud EX2 Ultra.

### Setting Up Joomla!

1. Add the Joomla! app to your My Cloud EX2 Ultra device (see "Adding an App" on page 67 for information on adding an app to your device).
2. On the App screen, click **Joomla!** in the left pane.
3. In the Configuration URL field, click the configuration URL link. The Joomla! Installation page displays.
4. Select a language from the scrolling window. This is the language that will be used during Joomla! installation.
5. Click **Next**.
6. Review the Joomla! Pre-installation check to ensure that all items passed, and then click **Next**.
7. Read the Joomla! license declaration, and then click **Next**.
8. Complete the Database Configuration screen with the following information, and then click **Next**.
  - **Database Type:** Select **MySQL** if not already selected.
  - **Host Name:** Enter **localhost**.
  - **Username:** Enter your MySQL account user name.
    - If you're using the phpMyAdmin app, enter **admin**.
  - **Password:** Enter your MySQL password.
    - If you're using the phpMyAdmin app, enter **admin**.
  - **Database Name:** Enter a name for your database to be used for Joomla!.
  - **Table Prefix:** Enter a table prefix. The prefix should be three - four characters long, contain only alphanumeric characters, and **MUST** end in an underscore. Make sure that the prefix chosen is not used by other tables.
    - You can also use the randomly generated table prefix pre-loaded into this field.
  - **Old Database Process:** Select one of the following options:
    - **Backup:** Backs up the old database.
    - **Remove:** Removes the old database
9. Keep the FTP Configuration screen default settings as they are and click **Next**.
10. Complete the Database Configuration screen with the following information:
  - **Site Name:** Enter a name for your Joomla! site.

- **Your Email:** Enter the email address of the individual that will act as the administrator for the Joomla! site.
  - **Admin Username:** Enter the user name you'll use to log into your Joomla! site.
  - **Admin Password:** Enter the password you'll use to log into your Joomla! site.
  - **Confirm Admin Password:** Reenter the password you entered in the Admin Password field.
11. Click **Install Sample Data**.
  12. Click **Next**.
  13. Review the information on the screen, and then click **Remove installation folder**.
  14. At the top of this page, click **Site**. Your Joomla! site has been created and installed on your My Cloud EX2 Ultra device.

## Appendix C: phpBB Setup Guide

phpBB™ is a popular Internet forum package written in the PHP scripting language. You can use phpBB to create your own customized forum that can be accessed and commented on from any Internet connection.

phpBB is one of the many apps available for use from your My Cloud EX2 Ultra device. Provided in this section are the steps you'll need to set up phpBB.

### Requirements

- MySQL database

### Setting Up phpBB

1. Add the phpBB app to your My Cloud EX2 Ultra device (see “Adding an App” on page 67).
2. On the App screen, click **phpBB** in the left pane.
3. In the Configuration URL field, click the configuration URL link. The phpBB Installation page displays.
4. Review the phpBB introduction, and then click the Install tab.



5. Review the Welcome to Installation information on your screen, and then click **Proceed to next step**.
6. Review the Installation compatibility information, and then click **Start Install**.
7. On the Database configuration screen, enter the following information, and then click **Proceed to Next Step**.
  - **Database Type:** Select **MySQL** if not already selected.

- **Database server hostname or DSN:** Enter **localhost**.
- **Database server port:** Leave this field blank.
- **Database name:** Enter a name for your database to be used for phpBB.
- **Database username:** Enter your MySQL account user name.
  - If you're using the phpMyAdmin app, enter **admin**.
- **Database password:** Enter your MySQL password.
  - If you're using the phpMyAdmin app, enter **admin**.
- **Table Prefix:** Enter a table prefix. The prefix must start with a letter and must only contain letters, numbers and underscores. Make sure that the prefix chosen is not used by other tables.

You can also use the randomly generated table prefix pre-loaded into this field.

8. Review the Database connection screen to ensure that it was performed successfully, and then click **Proceed to next step**.
9. Complete the Administrator Configuration screen with the following information, and then click **Proceed to next step**.
  - **Default board language:** Select the language for your bulletin board from the drop-down menu.
  - **Administrator username:** Enter the user name you'll use to log into your bulletin board.
  - **Administrator password:** Enter the password you'll use to log into your bulletin board.
  - **Confirm administrator password:** Reenter the password you entered in the Administrator password field.
  - **Contact e-mail address:** Enter the email address of the individual administering the board.
  - **Confirm contact e-mail:** Reenter the email address you entered in the Contact e-mail address field.
10. Review the Administrator details screen to ensure that the administrator configuration was successful, and then click **Proceed to next step**.
11. Review the screen, and then click **Proceed to next step**.
12. Review the information on the screen, and then click **Proceed to next step**.
 

**Note:** Keep the default settings on this screen for now. If you find that you need to update this information in the future, you can do so on the Administration Control Panel after phpBB is installed.
13. Review the information on the screen, and then click **Proceed to next step**.
14. Review the information on the screen. phpBB is now installed.

## Appendix D: Supported RAID Modes

The chart below identifies those modes that are supported for RAID storage.

Supported RAID Modes	1 Disk	2 Disks
Spanning	No	Yes
RAID 0	No	Yes
RAID 1	No	Yes
JBOD	Yes	Yes

## Appendix E: RAID Migrations

The chart below identifies the RAID migration path allowed on your My Cloud EX2 Ultra device.

From	To
JBOD (1 disk)	RAID 1 (2 disks)



## Appendix F: Safe Mode Firmware Update Procedures

If you see the following screen, use the steps outlined below to recover your device from safe mode.

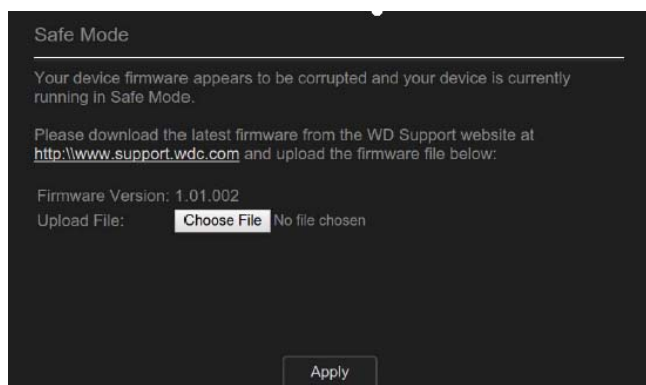

**Note:** Before performing these steps, download My Cloud EX2 Ultra firmware from the WD support website (<http://support.wd.com>) and save it to a location to which you can browse from your computer. Make sure to unzip the firmware file.

1. Log on to your router's DHCP LAN/Device Client Table to obtain the IP address for your device.
2. Type device IP address in a browser window. The Safe Mode UI appears.
3. Browse to the location where you saved the downloaded firmware.
4. Click **Apply** to load the firmware.
5. On the dialog box, click **OK**. The device reboots.
6. Once your reboot is completed, ensure that you clear your browser's cache. Check your browser's help to determine the best way to clear the cache.
7. Once your device has completed the reboot, we recommend that you do a system restore ("System Restore" on page 93).

## Appendix G: Technical Specifications

<b>Ethernet</b>	High performance (100/1000) Gigabit Ethernet connection
<b>Internal hard drives</b>	2 WD Red 3.5-inch SATA hard drives
<b>Supported protocols</b>	CIFS/SMB, NFS, FTP, AFP
<b>I/O ports</b> <b>Data transfer rate</b>	Gigabit Ethernet (RJ-45) port USB 3.0 up to 5 Gb/s  <i>*A USB 3.0 host and USB 3.0 certified cable are required to obtain USB 3.0 performance.</i>
<b>Compatibility</b>  <i>Note: Compatibility may vary depending on user's hardware configuration and operating system.</i>	<p>Operating systems:</p> <ul style="list-style-type: none"> <li>• Windows 10 (all versions)</li> <li>• Windows 8 (all versions)</li> <li>• Windows 7 (all versions)</li> <li>• Windows Vista (all versions including 64-bit)</li> <li>• Mac OS 10.11 El Capitan</li> <li>• Mac OS 10.10 Mavericks</li> <li>• Mac OS 10.9 Mountain Lion</li> <li>• Mac OS 10.8 Lion</li> </ul> <p>Browsers:</p> <ul style="list-style-type: none"> <li>• Internet Explorer 10 and higher</li> <li>• Safari 6.0 or higher on supported Windows and Mac computers</li> <li>• Firefox 30 or higher on supported Windows and Mac computers</li> <li>• Google Chrome 31 or higher on supported Windows and Mac computers</li> </ul>
<b>Physical dimensions</b>	
<b>Width</b>	3.90 in (99.06 mm)
<b>Length</b>	6.10 in (154.94 mm)
<b>Height</b>	6.75 in (171.45 mm)
<b>Power supply</b> <b>AC input voltage (AC adapter)</b> <b>AC input frequency</b> <b>DC output</b>	<p>Input voltage: 100V to 240V AC</p> <p>Input frequency: 50 to 60 Hz</p> <p>Output voltage: 12 VDC</p> <p>Power supply: 36W for 4TB, 8TB, 12TB capacity 48W for 0TB, 16TB capacity and above</p>
<b>Temperature</b>	<p>Operating temperature: 5°C to 35°C (41°F to 95 °F)</p> <p>Non-operating temperature: -20°C to 65°C (-4°F to 149 °F)</p>
<b>RoHs compliant</b>	Yes

PRELIMINARY

---

Information furnished by WD is believed to be accurate and reliable; however, no responsibility is assumed by WD for its use nor for any infringement of patents or other rights of third parties which may result from its use. No license is granted by implication or otherwise under any patent or patent rights of WD. WD reserves the right to change specifications at any time without notice.

Western Digital, WD, the WD logo, My Book, My Passport, and WD TV are registered trademarks in the U.S. and other countries; and WD My Cloud, WD Red, WD SmartWare, WD GreenPower, WD Photos, and WD TV Live are trademarks of Western Digital Technologies, Inc. Other marks may be mentioned herein that belong to other companies.

© 2016 Western Digital Technologies, Inc. All rights reserved.

Western Digital  
3355 Michelson Drive, Suite 100  
Irvine, California 92612 U.S.A.

4779-705148-A00 Jan 2016