

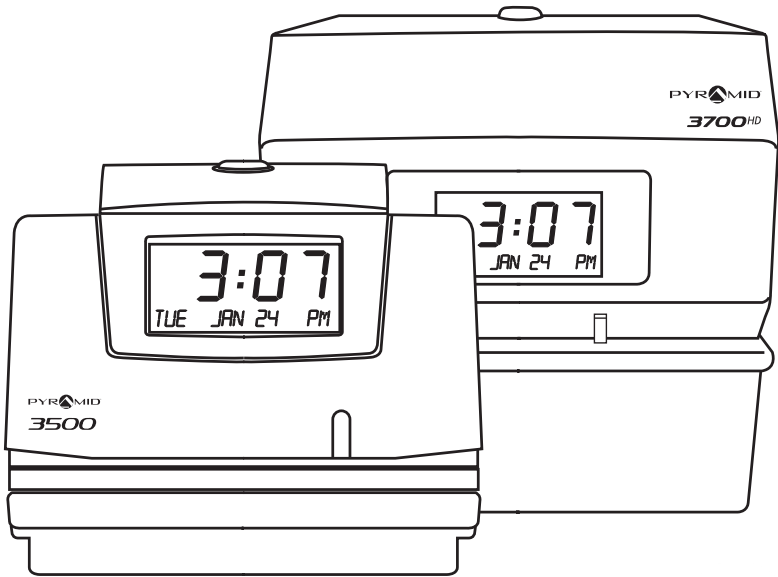

# ***3500/3700***

Time Clock & Document Stamp

## User Guide



Spanish and French user guide available at [pyramidthimesystems.com](http://pyramidthimesystems.com)

---

**Copyright Information**

© 2018 Pyramid Time Systems, LLC. All rights reserved.

Reproduction, adaptation or translation without prior written permission is prohibited, except as allowed under copyright laws.

The information contained herein is subject to change without notice. The only warranties for Pyramid Time Systems products are set forth in the express warranty statements accompanying such products. Nothing herein should be construed as constituting an additional warranty. Pyramid Time Systems shall not be liable for technical or editorial errors or omissions contained herein.

---

**TABLE OF CONTENTS**

PRODUCT OVERVIEW . . . . . 2

FEATURES . . . . . 2

CONTENTS . . . . . 3

SET UP & PROGRAMMING . . . . . 4

FEATURES SET UP . . . . . 5

PREPROGRAMMED MESSAGES . . . . . 6

TIME CARDS & PRINT FORMAT . . . . . 7

USING TIME CLOCK . . . . . 8

REPLACING RIBBON CARTRIDGE . . . . . 9

MASTER RESET . . . . . 10

FREQUENTLY ASKED QUESTIONS . . . . . 10

ACCESSORIES . . . . . 10

WARRANTY & CUSTOMER SUPPORT . . . . . 11

SPECIFICATIONS . . . . . 12

3500 MOUNTING TEMPLATE . . . . . 13

3700 MOUNTING TEMPLATE . . . . . 14

**PRODUCT OVERVIEW**

Thank you for choosing the **3500/3700** Time Clock & Document Stamp! The 3500/3700 is a versatile time clock, ready to perform employee time tracking, document stamping, & preset message stamping.

The 3500/3700 is able to punch employees In & Out & stamp time sensitive documents using one of 14 preset messages. Simple set-up & simple operation make this time clock a favorite with small business!

Please read through this User Guide for simple set-up & operation.

**TIME CLOCK & DOCUMENT STAMP : FEATURES**

Employee Capacity	Unlimited
Alignment	Manual Side
Preset Messages	14 Preset Messages for stamping time sensitive documents
Loading	Side
Ribbon Ink	Black
Language Printing	English, Spanish & French
Printing	Semi-automatic or manual
Display	Time, date & day of week (AM/PM or Military Time Format)
Printing Format	Date & Time (AM/PM, Military, Military Hundredths, Military Tenths)
Printing	Dot matrix
Automatic Time Reset	Short months, Leap Year & Daylight Saving Time
Battery Back-Up	Safeguards data & settings for up to 7 days without power
Tamper-Proof	Security lock protects against costly time theft
Warranty	1-Year manufacturer's limited warranty

CONTENTS

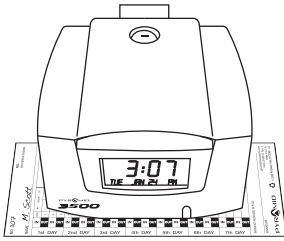

3500/3700 Time Clock & Document Stamp

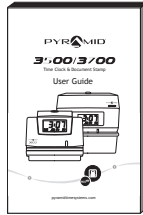

3500/3700 User Guide



35100-10 Time Card (25)



Security Keys (2)

WHAT YOU WILL NEED

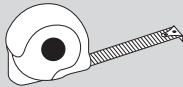

Tape Measure



Pencil



Philips Head Screw Driver



Power Drill (Optional)

KNOW YOUR SERIAL #

**IMPORTANT:**

Please write down serial # located on back of time clock before mounting.



Write your serial # here: 

--	--	--	--	--	--	--	--	--	--	--	--	--	--	--	--	--	--	--	--

## SET UP

- 1 Remove time clock from carton & place on a flat, level surface.

## WALL MOUNTING

- 1 Select a location convenient to employees clocking IN & OUT. Be sure power outlet is within 5 feet of mounting location.
- 2 Use masking tape to hold mounting template (page 13 & 14) on wall, making certain template is positioned so bottom of time clock is approximately 45 inches from floor.
- 3 Drill holes using template as a guide.
- 4 Remove template from wall & install #10 screws (not included), leaving approximately 3/16 inch of screws exposed. For sheetrock walls, use plastic anchors.
- 5 Hang time clock on wall, aligning key-holes on the rear with screw heads. Press downward on time clock until it lowers onto screws.
- 6 Plug unit into AC wall outlet.

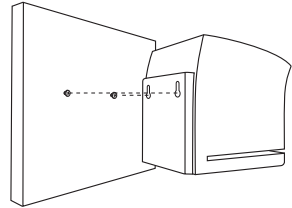

## PROGRAMMING

- 1 Use key to unlock and remove top/front cover. Locate programming buttons labeled SELECT, ▲(UP) & ▼(DOWN).
- 2 Press SELECT until desired feature is displayed (see chart on page 5).
- 3 Press ▲(UP) & ▼(DOWN) to scroll through feature options.
- 4 Press SELECT to save option setting & move to next feature.

**3500**

**SET-UP INSTRUCTIONS**

- 1 To change or set feature, press SELECT button until desired feature is displayed.
- 2 Use ▲ or ▼ button to change feature.
- 3 After display feature is changed, press SELECT button to change other features & to return to main display.

**PYRAMID**

888.479.7264  
pyramdtimesystems.com

SELECT   ▲   ▼

4-1072 Rev E

3500/3700 TIME CLOCK & DOCUMENT STAMP : FEATURES SET UP

FEATURE (SELECT)	DISPLAY	OPTIONS (SCROLL ▲▼)
Set Language	LANG = ENGLISH	ENGLISH, French (FRANCAIS), Spanish (ESPANOL)
Set Date Format	DATE FMT = MMDDYY	MM/DD/YR (USA), DD/MM/YR (EURO), YY/MM/DD
Set Year	SET YEAR = 2010	DISPLAYED YEAR +/- 1 Year
Set Month	SET MONTH = JAN	DISPLAYED MONTH +/- 1 Month
Set Date	SET DAY = 1	DISPLAYED DATE +/- 1 Day
Set Daylight Savings Time (DST) Rule	DAYLT SAV = USA	USA: USA DST: Begins 2nd SUN of MAR, Ends 1st SUN of NOV EURO: European DST: Begins Last SUN of MAR, Ends Last Sun of OCT OTHER: Set a custom DST Rule. <sup>1</sup> OFF: No adjustment for DST.
Set Format	DSPLY FMT = AM/PM	AM/PM: 12 Hour, MIL: Military, 24 Hour
Set Printed Time Format	PRINT FMT = AM/PM	AM/PM: 12 Hour (e.g. 3:30PM) MIL: Military, 24 Hour (e.g. 15:30) ATAAP: Military, 24 Hour, Minutes expressed in hundredths of one hour (e.g. 15.50) 24H.1: Military, 24 Hour, Minutes expressed in tenths of one hour (e.g. 15.5)
Set Print Direction	PRINT DIR = RIGHT	Right = Print on the right side of time card. Left = Print on the left side of time card.
Set Format	FMT = DATE TIME	SEE PRINTING FORMAT PAGE 6
Set Hour	SET HOUR = 12AM	DISPLAYED HOUR +/- 1 Hour
Set Minutes	SET MINUTES = 0	DISPLAYED MINUTE +/- 1 Minute

<sup>1</sup> SELECT DAYLT SAV=OTHER. SCROLL & SELECT START & END SUNDAY (Available options are the 1<sup>st</sup>, 2<sup>nd</sup>, 3<sup>rd</sup>, 4<sup>th</sup> and last Sunday of each month). Remember: The number of weeks in a given month changes each year. You will have to reprogram your custom DST if either the START or END date falls on the last day of the month.

MESSAGES & FORMAT

The 3500/3700 functions as a document stamp and is preprogrammed with 14 common message formats.

PREPROGRAMMED MESSAGES

- 1 In the SET FMT MSGS menu, press ▲(UP) or ▼(DOWN) to choose “YES”.
- 2 Press SELECT.
- 3 Press ▲(UP) or ▼(DOWN) to scroll through preprogrammed messages. (see chart below)<sup>1</sup>
- 4 Press SELECT to choose desired message<sup>2</sup> & advance to next menu.

SET FORMAT MESSAGES (SET FMT MSGS)

DISPLAY	EXAMPLE
FMT=DATE TIME(Default Settings)	JUL12 07:46PM
FMT=DATE YR TIME	JUL12'15 07:46PM
FMT=DATE YR APVD	JUL 12' 15 APVD
FMT=DATE YR FAXD	JUL 12' 15 FAXD
FMT=DATE YR FILE	JUL 12' 15 FILE
FMT=DATE YR IN	JUL 12' 15 IN
FMT=DATE YR OUT	JUL 12' 15 OUT
FMT=DATE YR PAID	JUL 12' 15 PAID
FMT=DATE YR RCVD	JUL 12' 15 RCVD
FMT=DATE YR SENT	JUL 12' 15 SENT
FMT=DATE YR ORIG	JUL 12' 15 ORIG
FMT=DATE YR VOID	JUL 12' 15 VOID
FMT=DATE YR USED	JUL 12' 15 USED
FMT=DATE YR Cmpl	JUL 12' 15 Cmpl



<sup>1</sup>By default, clock will print DATE TIME format if no message is selected.

<sup>2</sup>Selected preprogrammed message will print first (date stamp).



**TIME CARDS**

NAME		NO. PAY PERIOD ENDING	
DATE	HR	MIN	OT
1st DAY	7:00 AM		
	8:00 AM		
	9:00 AM		
	10:00 AM		
	11:00 AM		
	12:00 PM		
	1:00 PM		
2nd DAY	7:00 AM		
	8:00 AM		
	9:00 AM		
	10:00 AM		
	11:00 AM		
	12:00 PM		
	1:00 PM		
3rd DAY	7:00 AM		
	8:00 AM		
	9:00 AM		
	10:00 AM		
	11:00 AM		
	12:00 PM		
	1:00 PM		
4th DAY	7:00 AM		
	8:00 AM		
	9:00 AM		
	10:00 AM		
	11:00 AM		
	12:00 PM		
	1:00 PM		
5th DAY	7:00 AM		
	8:00 AM		
	9:00 AM		
	10:00 AM		
	11:00 AM		
	12:00 PM		
	1:00 PM		
6th DAY	7:00 AM		
	8:00 AM		
	9:00 AM		
	10:00 AM		
	11:00 AM		
	12:00 PM		
	1:00 PM		
7th DAY	7:00 AM		
	8:00 AM		
	9:00 AM		
	10:00 AM		
	11:00 AM		
	12:00 PM		
	1:00 PM		
TOTAL			
BASE			
AMOUNT			
TOTAL EARNINGS			
TOTAL DEDUCTIONS			
BALANCE DUE			
NO. OF EMPLOYEES			
SICK			
FEDERAL			
INSURANCE			
GEN. FUND			
SCHOOL LEAVE			
SICKLEAVE			
DUES			
BONUS			
MISC.			
PAYMENT RECEIVED IN FULL			
SIGNATURE		<small>                 WWW.PYRAMIDTIMESYSTEMS.COM                  FORM 3500/3700 Rev. C                  MADE IN U.S.A.                  © 2002 PYRAMID TIME SYSTEMS, LLC             </small>	

Time card #35100-10, 35100-10S, or 35100-10F

**TIME CARD PRINT FORMAT**

The time card (#35100-10, 35100-10S, or 35100-10F) is used for weekly pay periods. Printing will appear as follows:

PUNCH IN                      JUL 12    7:00AM  
Prints Month, Date & Punch Time

PUNCH OUT                    JUL 12    3:00PM  
Prints Month, Date & Punch Time

USING TIME CLOCK

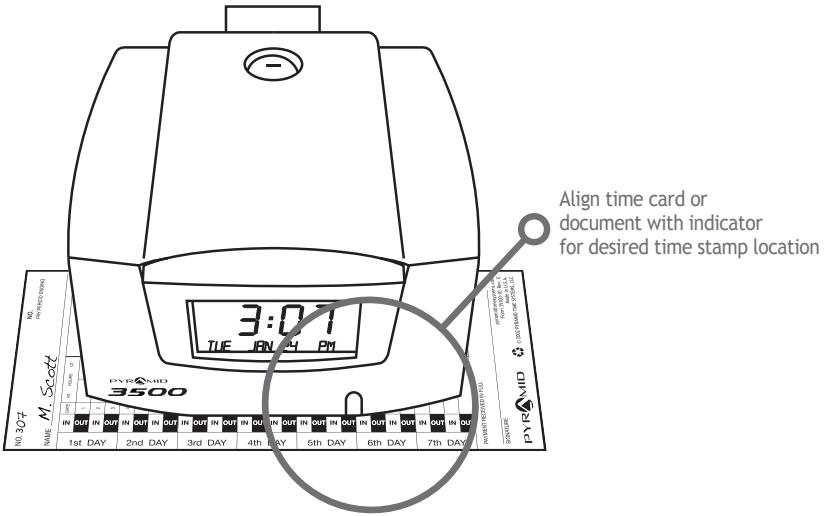

- ① To punch time card or stamp document, gently feed time card (35100-10, 35100-10S, or 35100-10F) or document into slot at base of time clock. Use indicator to align time card or document to desired time stamp location.
- ② Continue to feed time card or document until the print actuator is activated.

## REPLACING RIBBON CARTRIDGE

- ① Unplug time clock **\*IMPORTANT\***.
- ② Unlock and remove cover.
- ③ Turn clock on its side so ribbon cartridge & holder are on top.
- ④ Manually slide ribbon cartridge carriage to far right (see diagram).
- ⑤ Remove old ribbon cartridge. Gently push the ribbon tab away from the ribbon cartridge and remove the cartridge.
- ⑥ Snap in new cartridge while turning the ribbon advance knob. Make certain the ribbon and the clear plastic protector slide completely over print head.
- ⑦ Replace cover, lock unit & plug in.
- ⑧ Test time card or document for print quality.

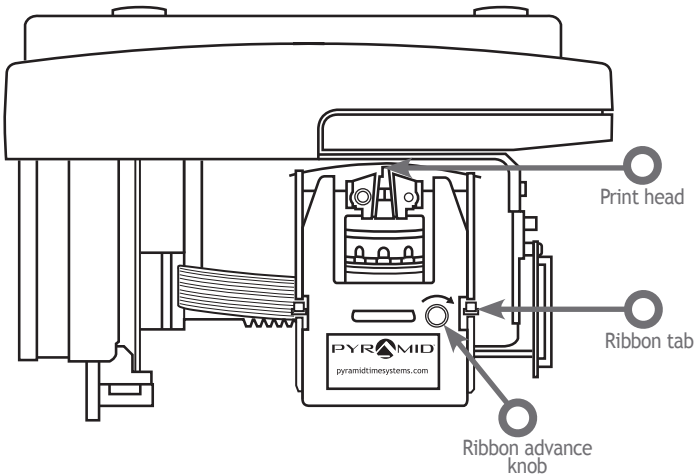

If ribbon is not completely over print head the resulting print will show incomplete characters. If ribbon cartridge is not completely snapped in holder, the resulting print will be increasingly lighter.

## MASTER RESET

- ① Unplug time clock.
- ② Press & hold ▲(UP) button while plugging unit back in.
- ③ Release ▲(UP) button when “TIME NOT SET” appears on display screen.
- ④ Re-program time clock.

## FAQS

**Q:** Do I have to use special cards?

**A:** Pyramid 35100-10 or 35100-10F (French) cards are designed for use with the 3500/3700 when it is used for payroll, but you can use it to stamp other documents.

**Q:** What does ATAAP mean?

**A:** ATAAP is the acronym used by the U.S. government that describes how time is accounted for using hundredths of hour (i.e. one and a quarter hours equal 1.25 hours).

## ACCESSORIES

### 3500/3700 : ACCESSORIES

PART #	DESCRIPTION
4000R	Replacement Ink Ribbon Cartridge
35100-10	Time Cards (100pk)
35100-10M	Time Cards (1000pk)
35100-10S	Time Cards (100pk) Spanish
35100-10F	Time Cards (100pk) English/French
35100-10FM	Time Cards (1000pk) English/French
400-3	25 Capacity Adjustable Time Card Rack
400-X	25 Capacity Expanding Time Card Rack
300-1	Heavy Duty Metal Time Card Rack

### LIMITED HARDWARE WARRANTY

- Pyramid Time System warrants its equipment to original user against defective material or workmanship for a period of 1-year from date of purchase. Proof of purchase & purchase date are required for warranty service on this product.
- Please remember to register your product at [pyramidtimesystems.com/ProductRegistration/](http://pyramidtimesystems.com/ProductRegistration/).
- Pyramid Time Systems' responsibility under this warranty is limited to replacement of defective part(s). Replacement is the sole discretion of Pyramid Time Systems.
- For Return Shipments to Pyramid Time Systems, product must be shipped in its original carton or equivalent. The cost & method of return freight for warranteed product is the sole responsibility of the customer. Pyramid Time Systems will not assume any responsibility for loss or damage incurred in shipping.
- Pyramid Time Systems reserves the right to determine whether parts failed because of defective material, workmanship or other causes.
- Failure caused by accident, alteration, misuse or improper packaging of returned unit is not covered by this warranty.
- Any repair done by the customer without the consent from Pyramid Time Systems will automatically void the warranty.
- Users in countries other than Canada and USA should contact the Dealer from whom the unit was purchased.
- The rights under this warranty are limited to the original user and may not be transferred to subsequent users.

### CONTACT US:

For more information, visit [pyramidtimesystems.com](http://pyramidtimesystems.com) or call our technical support team at **888.479.7264 ext 1** during regular business hours: **8am-5pm EST, M-F**, or email [customersupport@ptitime.com](mailto:customersupport@ptitime.com)

SPECIFICATIONS

3500/3700 : SPECIFICATIONS

OPERATING CONDITIONS	
Temperature	0° C - 50° C, 32° F - 122° F
Humidity	10-95% RH, non condensing
POWER	
	100-240VAC, 50/60 Hz
POWER FAILURE	
Battery Back-Up	7 Days, Data & Time
Battery Life	10 Years
CALENDAR	
	Automatic Leap Year & Daylight Savings Time, Year up to 2099
CLOCK ACCURACY	
	Less than 30 seconds/year
WEIGHT	
3500	2.6 lbs (1.17 kg)
3700	7 lbs (3.175 kg)
DIMENSIONS	
3500	6.3125 in x 5.75 in x 7 in (16.03 cm x 14.6 cm x 17.78 cm)
3700	8.25 in x 8 in x 6.8125 in (20.95 cm x 20.32 cm x 17.30 cm)
CERTIFICATIONS	
	UL and CUL (power supply)
MOUNTING	
	Desktop or Wall mountable

Screw Guide Template Below Is Actual Size

4.375"



UP 



Level Line Marker

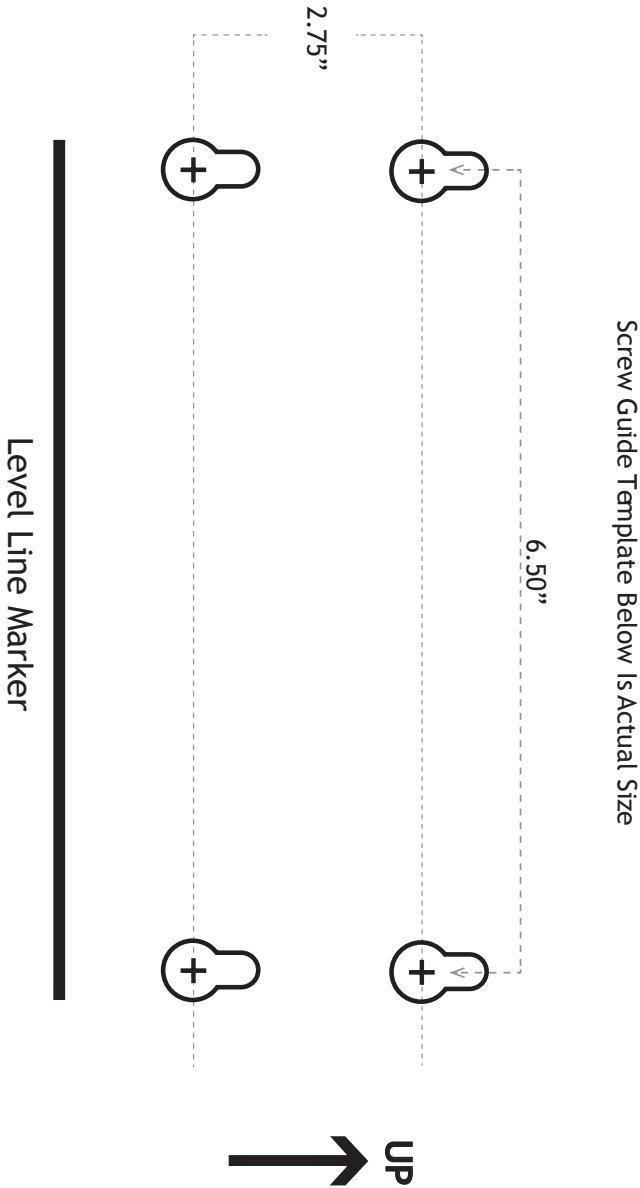



# SIMPLE : SMART<sup>®</sup>



## CONTACT US:

For more information, visit [pyramidthimesystems.com](http://pyramidthimesystems.com)  
or call our technical support team at **888.479.7264**  
during regular business hours: **8am-5pm EST,**  
**Monday-Friday.**

Copyright © 2018 Pyramid Time Systems, LLC. All rights reserved.