











A  Cam Lock 1 Pc + 2 extra Pcs	B  Klix Cam 1 Pc + 2 extra Pcs	C  Dowel 1 Pc + 2 extra Pcs	D  Adjustable Glide 2 Pcs	E  Cam Cover 1 Pc + 2 extra Pcs	F  Cam Cover for Insert 3 Pcs + 2 extra Pcs	G  Cam Cover for Dowel 2 Pcs + 2 extra Pcs	H  6 Hole L-Bracket 1 Pc	I  Screw #4*5/8" 12 Pcs + 2 extra Pcs	J  Cam Cover 1 Pc + 2 extra Pcs
K  Flat Bracket 1Pc									

STEP 1



STEP 2

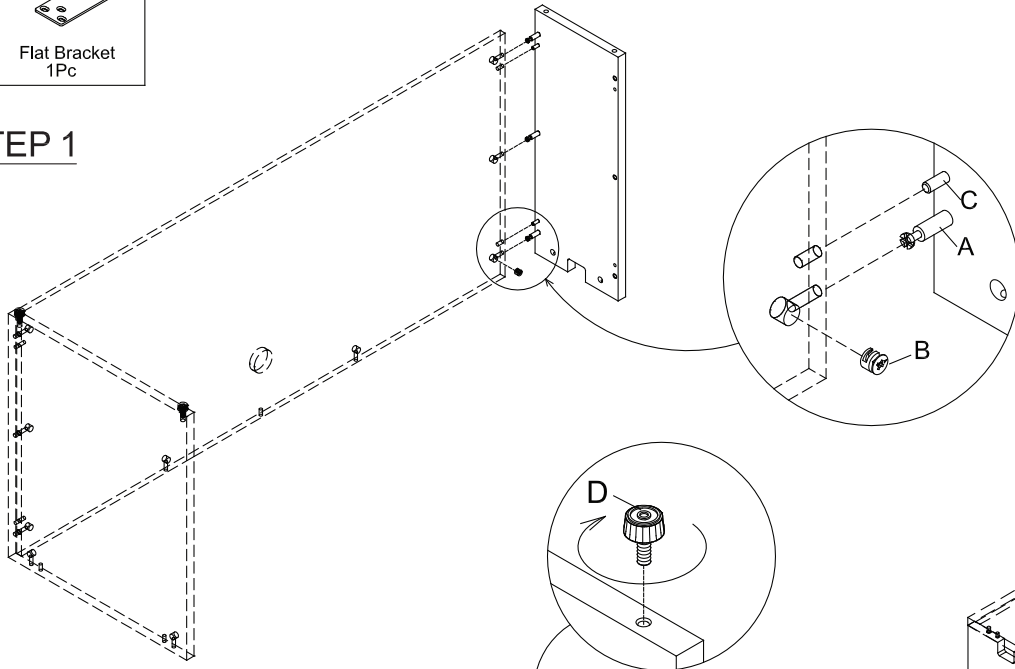
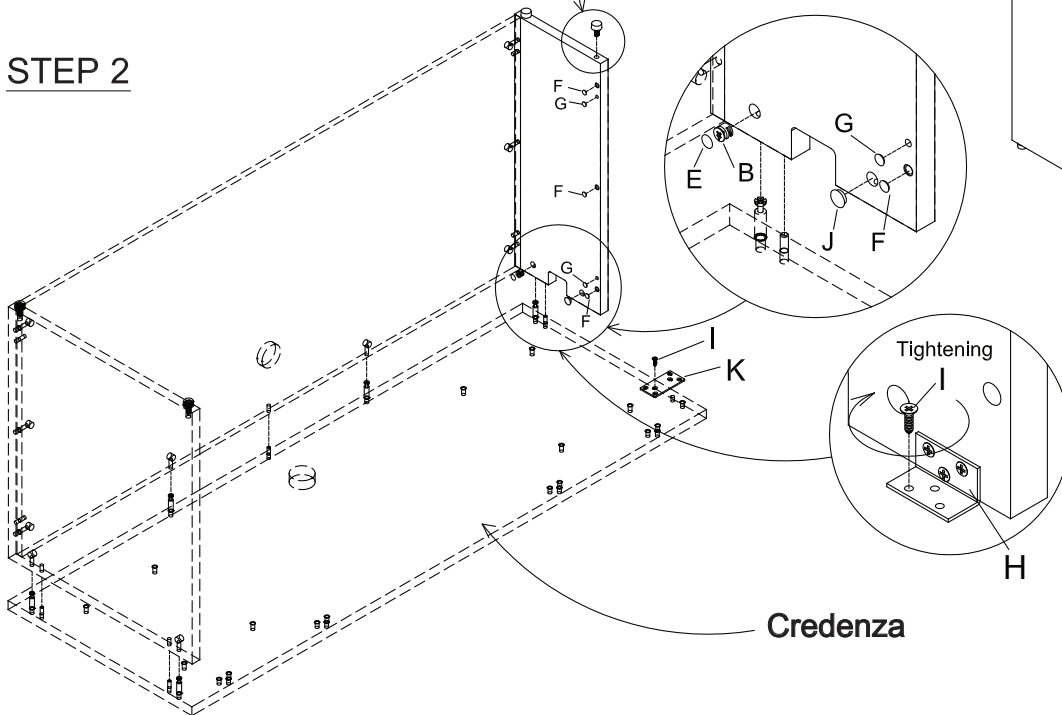



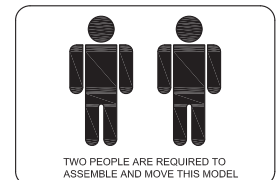







COMPLETED ASSEMBLY



IMPORTANT NOTE:

- Place all laminated parts on a clean and smooth surface such as a rug or carpet to avoid the parts from being scratched.
- Check to make sure that you have all parts and hardware.
- Remove all wrapping materials, including staples and packaging straps before your start to assemble.
- Do not tighten all screws/bolts until pieces are completely assembled.
- Keep all hardware parts out of children's reach.
- It is recommended for 2 persons to complete this assembly.

A  Camme de verrouillage 1 pc + 2 pcs supplémentaires	B  Camme Klix 1 pc + 2 pcs supplémentaires	C  Goujon 1 pc + 2 pcs supplémentaires	D  Glisseur réglable 2 pcs	E  Capuchon de came 1 pc + 2 pcs supplémentaires	F  Capuchon de came pour insert 3 pcs + 2 pcs supplémentaires	G  Capuchon de came pour douille 2 pcs + 2 pcs supplémentaires	H  Support en L à six trous 1 pc	I  Vis #4 x 1/2" 12 pcs + 2 pcs supplémentaires	J  Capuchon de came 1 pc + 2 pcs supplémentaires
---	--	--	--	--	--	--	--	---	--

K  Support plat 1 pcs

ÉTAPE 1

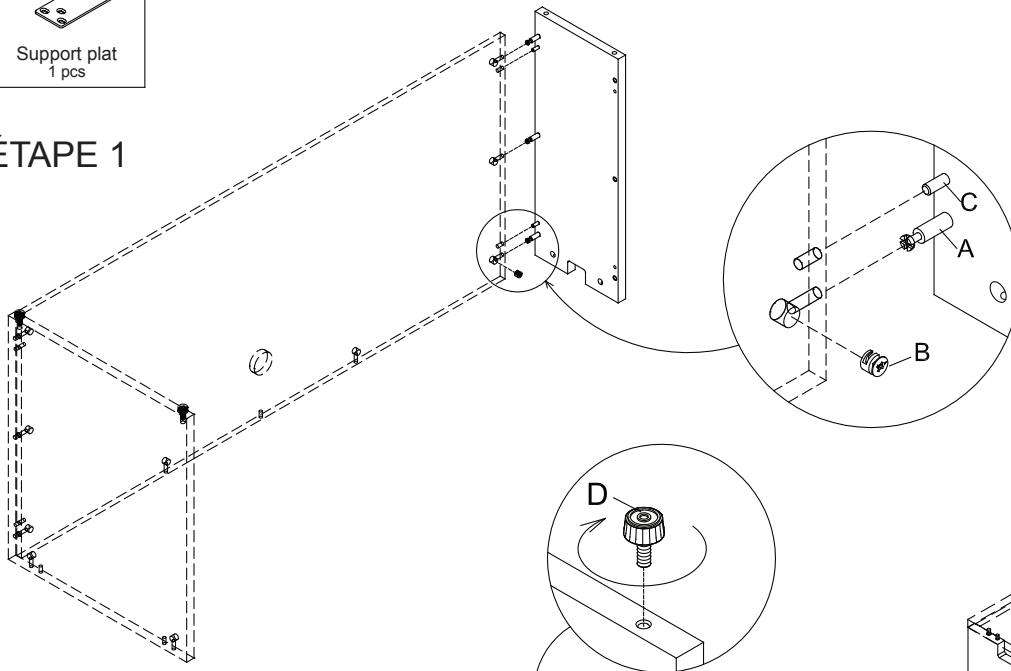

ÉTAPE 2

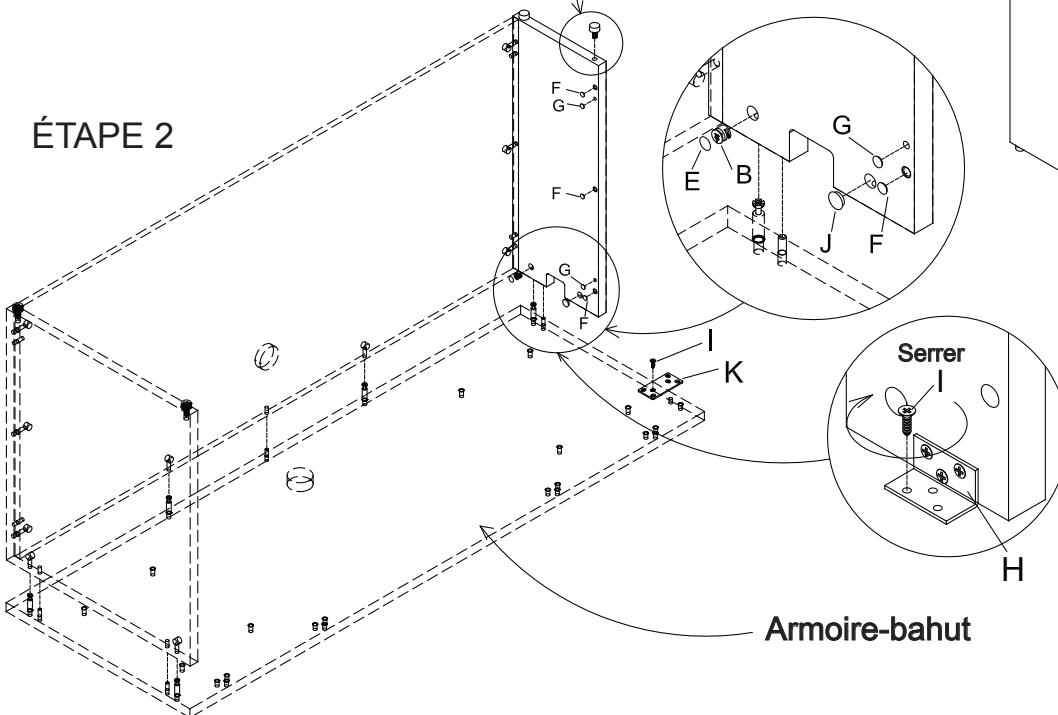



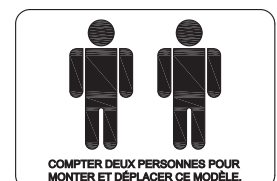





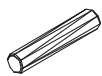
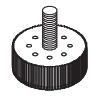

ASSEMBLAGE TERMINÉ



REMARQUE IMPORTANTE :

- Placer toutes les pièces contrecollées sur une surface propre et lisse, comme de la moquette ou un tapis, pour éviter qu'elles soient éraflées.
- S'assurer d'être en possession de toutes les pièces et de toute la quincaillerie
- Retirer tout matériau d'emballage, y compris agrafes et sangles, avant de commencer le montage.
- Ne pas serrer toutes les vis/tous les boulons avant que l'ensemble ne soit terminé
- Toute la quincaillerie doit rester hors de portée des enfants.
- Il est recommandé de travailler à 2 pour effectuer ce montage.

A  Seguro de ajuste 1 pza. + 2 pzas. extras	B  Leva 1 pza. + 2 pzas. extras	C  Espiga 1 pza. + 2 pzas. extras	D  Pata ajustable 2 pzas.	E  Cubierta de Leva 1 pza. + 2 pzas. extras	F  Cubierta de leva para insertar 3 pzas. + 2 pzas. extras	G  Cubierta de leva para espiga 2 pzas. + 2 pzas. extras	H  Escuadra de 6 orificios 1 pza.	I  Tornillo #4 x 1/4" 12 pzas. + 2 pzas. extras	J  Cubierta de Leva 1 pza. + 2 pzas. extras
---	---	---	--	---	--	---	---	---	---

K  Ménsula plana 1 pza.
--

PASO 1

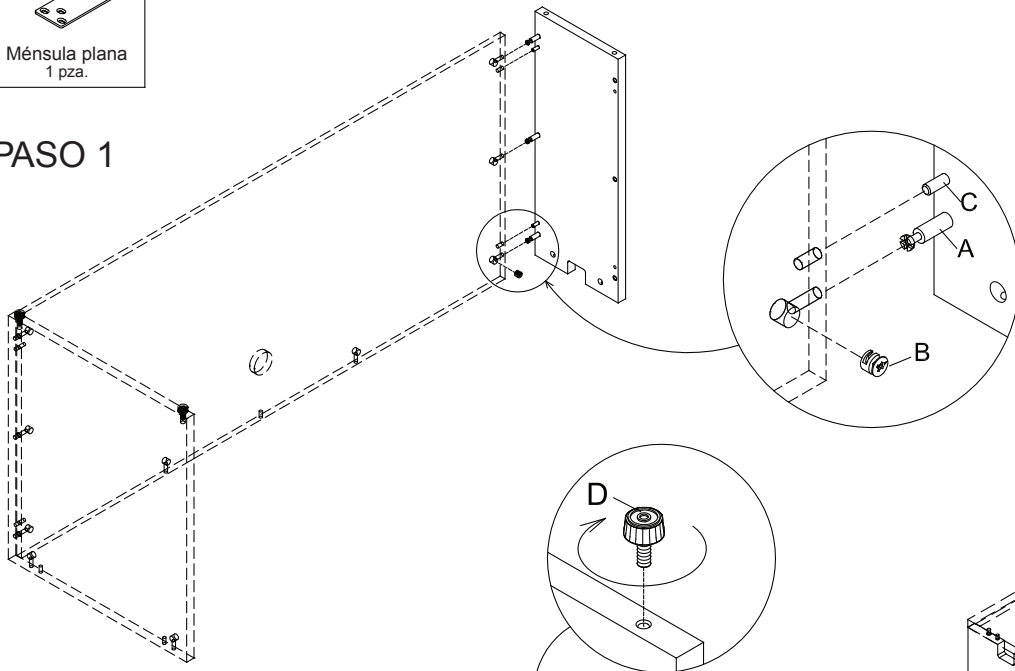

PASO 2

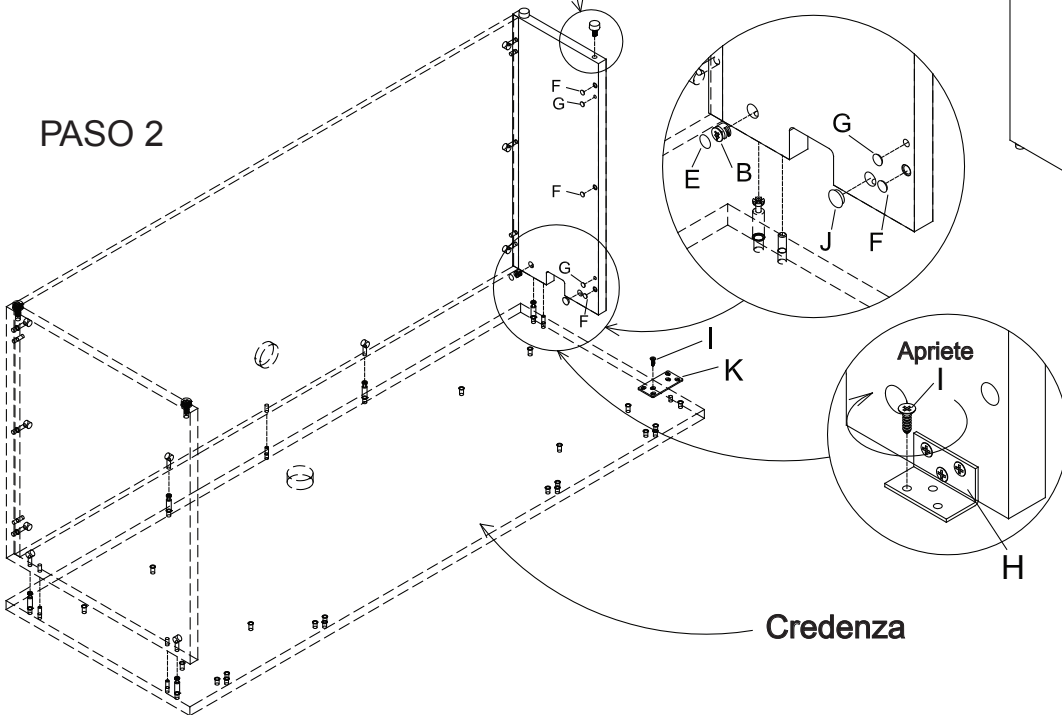

ENSAMBLE COMPLETO

Credenza



NOTA IMPORTANTE:

- Coloque todas las partes laminadas sobre una superficie limpia y uniforme (como un tapete o la alfombra) para evitar que se rayen.
- Asegúrese de tener todas las partes y la ferretería.
- Antes de empezar a ensamblar, retire todos los materiales de empaque, incluyendo grapas y cintas.
- No apriete todos los tornillos y pernos sino hasta haber ensamblado todas las piezas.
- Mantenga toda la ferretería fuera del alcance de los niños.
- Se recomienda que dos personas realicen el ensamble.

Instructions

CALL US FIRST! DO NOT RETURN TO STORE.

For immediate help with assembly or product information call our toll-free number: **1-888-598-7316** Mon. - Fri. 7am to 7 pm CST
Our staff is ready to provide assistance. Damaged or missing parts ship from our facility in 1-2 business days.

Please provide the following information:

1. Full Name
2. Physical Address – do not include P.O. Box as our carriers cannot deliver to P.O. Boxes
3. Phone Number
4. Model Number
5. Part Number
6. Invoice #
7. Date of Purchase

Note: Our policy is to send all parts requests via normal ground transportation. If your requirements are to have these parts via overnight/next day, please provide your designated carrier and account number. Replacement panels are not available. If any damage has occurred during shipment please return the entire unit to place of purchase for credit and replacement. Original invoice may be required.

Before you begin:

Open, identify and count all parts prior to assembly. Lay out the parts on a non-abrasive surface such as carpet or blanket.

Instructions

APPELEZ-NOUS D'ABORD! NE REVENEZ PAS AU MAGASIN.

Pour obtenir une aide immédiate concernant l'assemblage ou des informations sur les produits, appelez notre numéro sans frais :
1-888-598-7316 Lun. - vend. 7h à 19 h CST Notre personnel vous attend pour vous offrir son aide.
Les pièces endommagées ou manquantes sont expédiées de nos locaux sous 1 à 2 jours ouvrables.

Veillez inclure les informations suivantes :

1. Nom complet
2. Adresse physique – ne pas inclure de boîte postale, car nos porteurs ne peuvent pas livrer à ces boîtes.
3. Numéro de téléphone
4. Numéro de modèle
5. Numéro de pièce
6. Numéro de facture
7. Date d'achat

Remarque : Notre politique est d'envoyer toutes les pièces demandées par transport terrestre normal. Si vous voulez recevoir ces pièces le jour suivant, indiquez votre porteur désigné ainsi qu'un numéro de compte. Nous ne fournissons pas de panneaux de rechange. En cas d'endommagement en cours de transport, renvoyez l'unité entière au lieu d'achat pour recevoir un crédit ou un échange. La facture originale vous sera peut-être demandée.

Avant de commencer:

Ouvrez, identifiez et comptez toutes les pièces avant l'assemblage. Disposez à plat les pièces sur une surface non abrasive comme un tapis ou une couverture.

Instrucciones

¡LLÁMENOS PRIMERO! NO DEVUELVA EL PRODUCTO A LA TIENDA.

Para recibir ayuda inmediata con el ensamble o información del producto, llame a nuestro número gratuito: **1-888-598-7316**
De lunes a viernes de 7 a.m. a 7 p.m., hora del Centro. Nuestro personal está preparado para brindarle asistencia.
Las partes dañadas o faltantes saldrán de nuestras instalaciones en el transcurso de 1 a 2 días hábiles.

Recuerde proporcionar la siguiente información:

1. Nombre completo
2. Domicilio físico – No incluya apartados postales debido a que no podemos realizar entregas en un apartado postal.
3. Número telefónico
4. Número de modelo
5. Número de parte
6. Número de factura
7. Fecha de compra

Nota: Nuestra política es enviar todas las solicitudes de partes por transporte terrestre regular. Si usted solicitó el envío de estas partes durante la noche o con entrega al día siguiente, proporcione el nombre de su compañía de mensajería y su número de cuenta. Los paneles de repuesto no están disponibles. Si ocurrió algún daño durante el envío, devuelva la unidad completa al lugar de compra para su devolución o reposición. Es posible que le pidan la factura original.

Antes de iniciar:

Abra, identifique y cuente todas las partes antes del ensamble. Coloque todas las partes en una superficie no abrasiva, como una alfombra o sábana.