

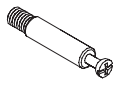





TUN010CL	TUN011KC		TUN021AG	TUN013LB	TUN014SC	TUN015BG
A 	B 	C 	D 	E 	F 	G 
Cam Lock 12Pcs + 2 extra Pcs	Klix Cam 12Pcs + 2 extra Pcs	Dowel 10Pcs + 2 extra Pcs	Adjustable Glide 4Pcs	I-Bracket 2Pcs	Screw M6 x 15 12Pcs + 2 extra Pcs	Cam Cover 12Pcs + 2 extra Pcs

### STEP 1

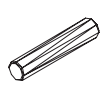

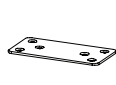
COMPLETED ASSEMBLY

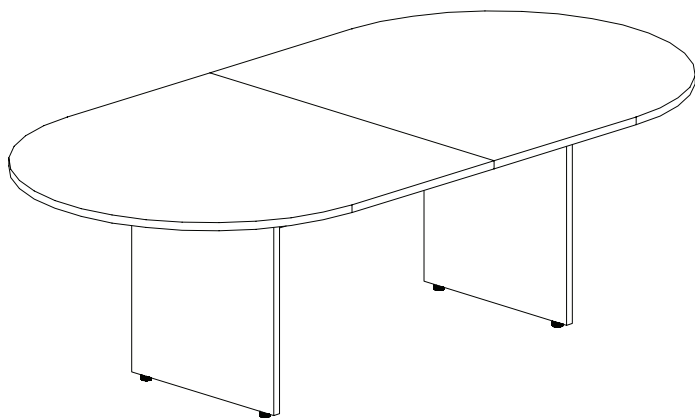
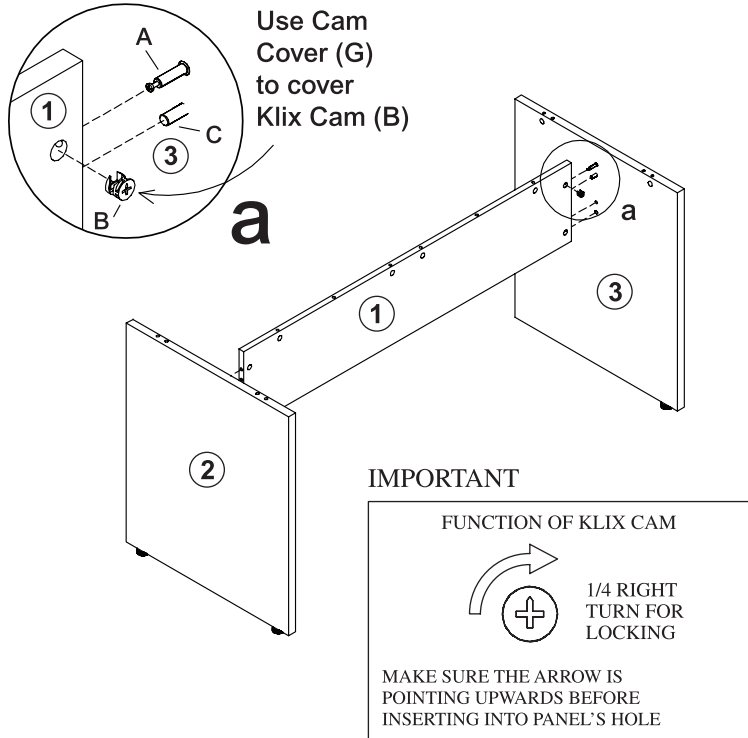

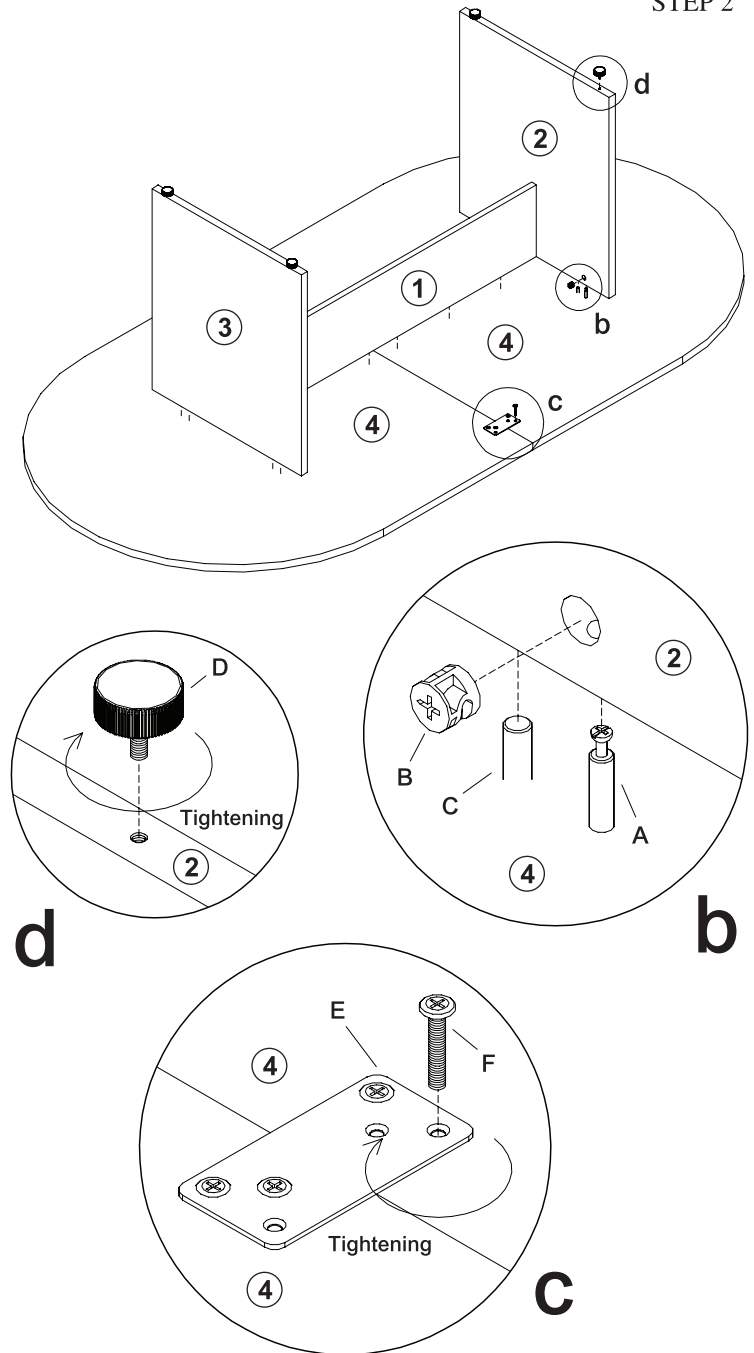



### STEP 2

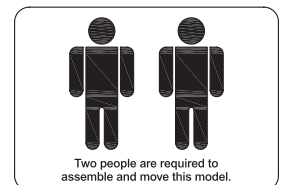

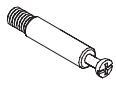
### IMPORTANT NOTE:

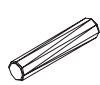
- Place all laminated parts on a clean and smooth surface such as a rug or carpet to avoid the parts from being scratched.
- Check to be sure that you have all parts and hardware.
- Remove all wrapping materials, including staples and packing straps before you start to assemble.
- Don't tighten all screws/bolts until all completely assembled.
- Keep all hardware parts out of reach of children.
- It is recommended for 2 persons to complete this assembly.

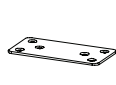

TUN010CL	TUN011KC		TUN021AG	TUN013LB	TUN014SC	TUN015BG
A 	B 	C 	D 	E 	F 	G 
Verrou à came 12mcx + 2 mcx supplémentaires	Came Klix 12mcx + 2 mcx supplémentaires	Cheville 10mcx + 2 mcx supplémentaires	Patin ajustable 4mcx	I-Support 2mcx	Vis M6 x 15 12mcx + 2 mcx supplémentaires	Couvercle de came 12mcx + 2 mcx supplémentaires

### ÉTAPE 1

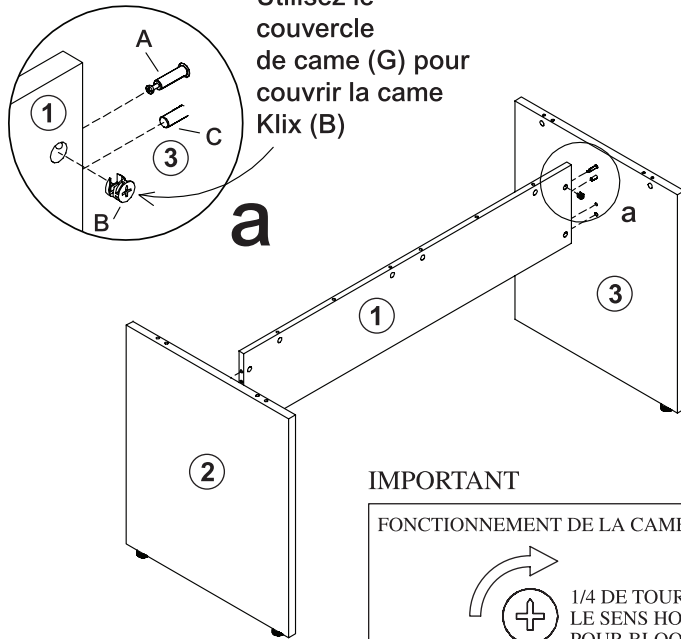

### IMPORTANT

#### FONCTIONNEMENT DE LA CAME KLIX



1/4 DE TOUR DANS LE SENS HORAIRE POUR BLOQUER

ASSUREZ-VOUS QUE LA FLÈCHE PENTE VERS LE HAUT AVANT L'INSERTION DANS LE TROU DU PANNEAU.

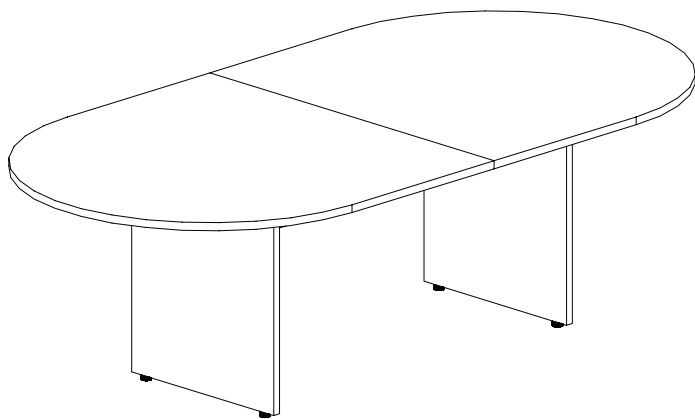

ASSEMBLAGE COMPLÉTÉ

### ÉTAPE 2

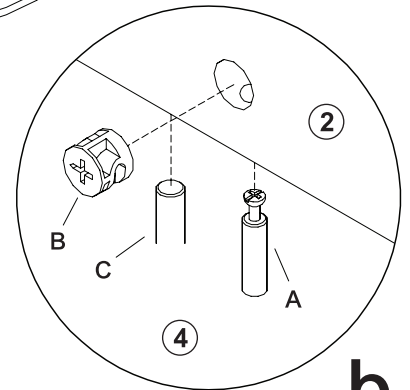
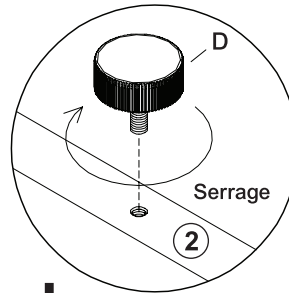
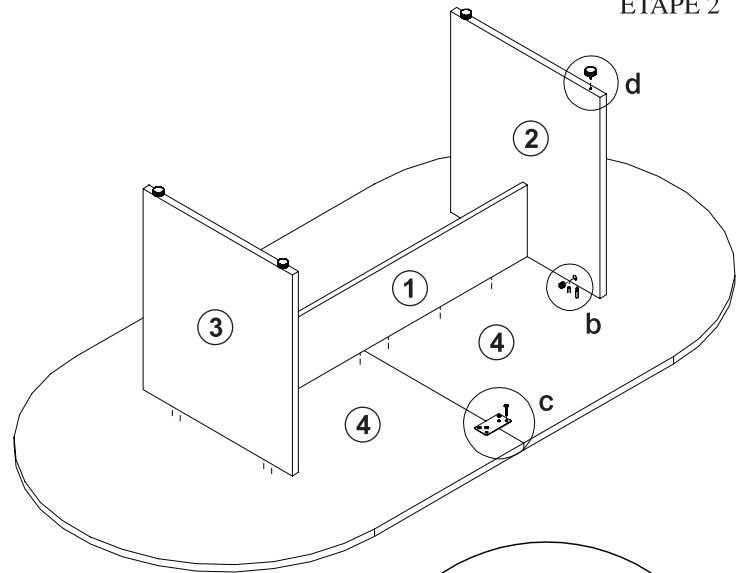

d

b

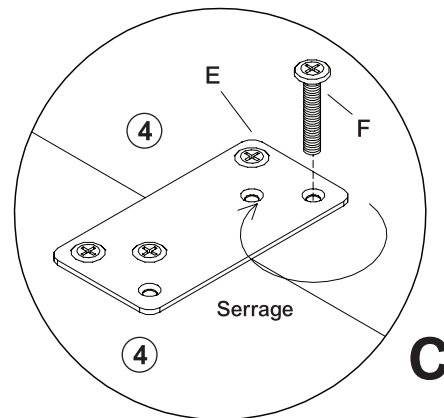





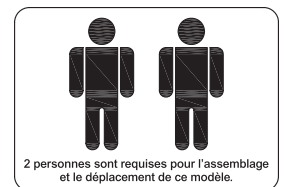

C

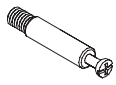
### NOTE IMPORTANTE :

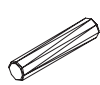
- Déposez toutes les pièces laminées sur une surface propre et douce comme sur une carpe ou un tapis afin d'éviter l'éraflure des pièces.
- Vérifiez pour vous assurer que vous avez toutes les pièces et toute la quincaillerie.
- Enlevez tout le matériel d'emballage, incluant les agrafes et les courroies d'emballage avant de débuter l'assemblage.
- Ne serrez pas aucun des boulons/vis avant d'avoir assemblé toutes les pièces.
- Gardez toutes les pièces de quincaillerie hors de portée des enfants.
- Il est recommandé que 2 personnes effectuent cet assemblage.



TUN010CL	TUN011KC		TUN021AG		TUN014SC	TUN015BG
A 	B 		D 	E 	F 	G 
Seguro de ajuste 12 pzas. + 2 pzas. extras	Leva 12 pzas. + 2 pzas. extras	Taquete 10 pzas. + 2 pzas. extras	Riel ajustable 4 pzas.	Soporte I 2 pzas.	Tornillo M6 x 15 12 pzas. + 2 pzas. extras	Cubierta de levas 12 pzas. + 2 pzas. extras

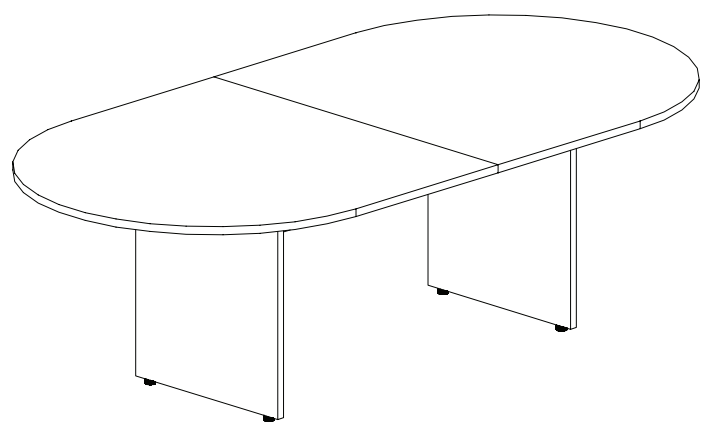
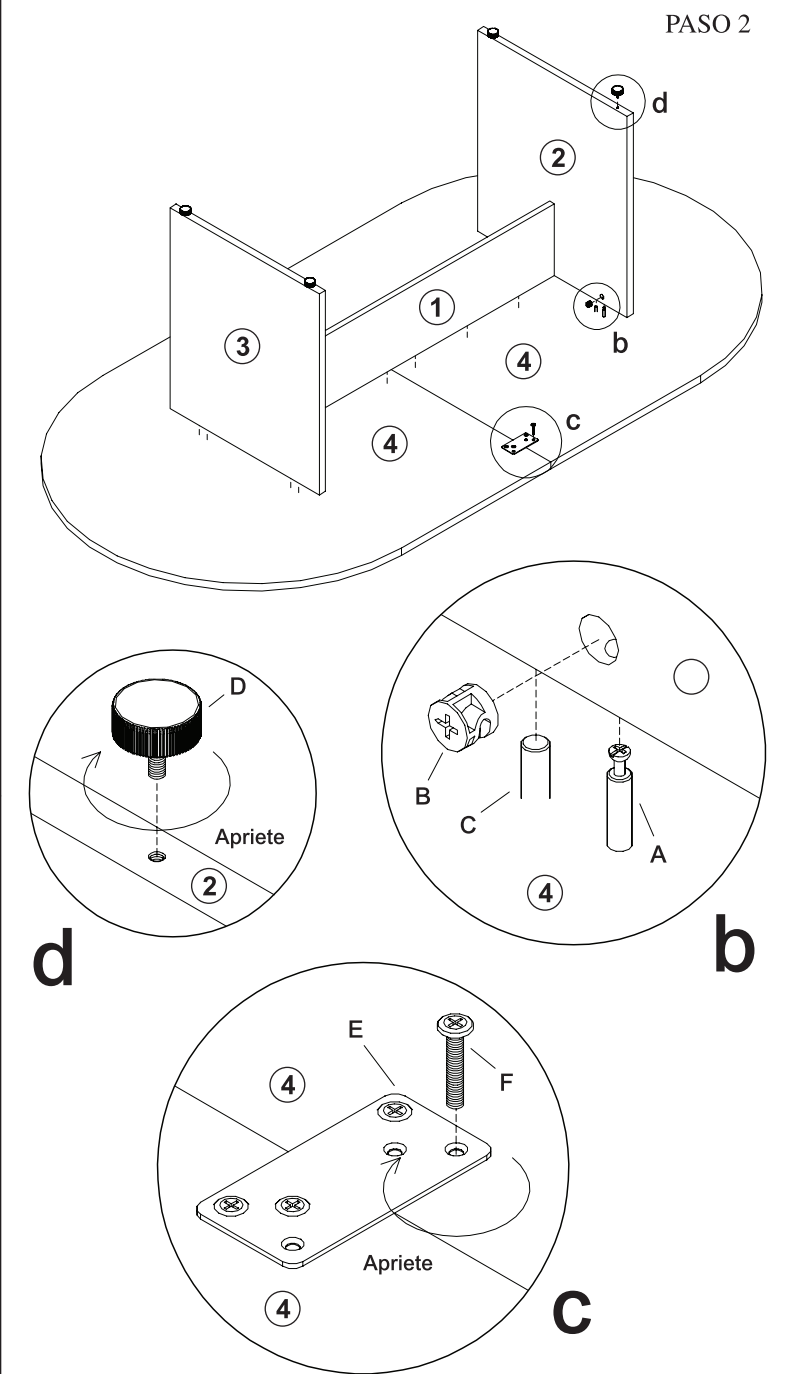
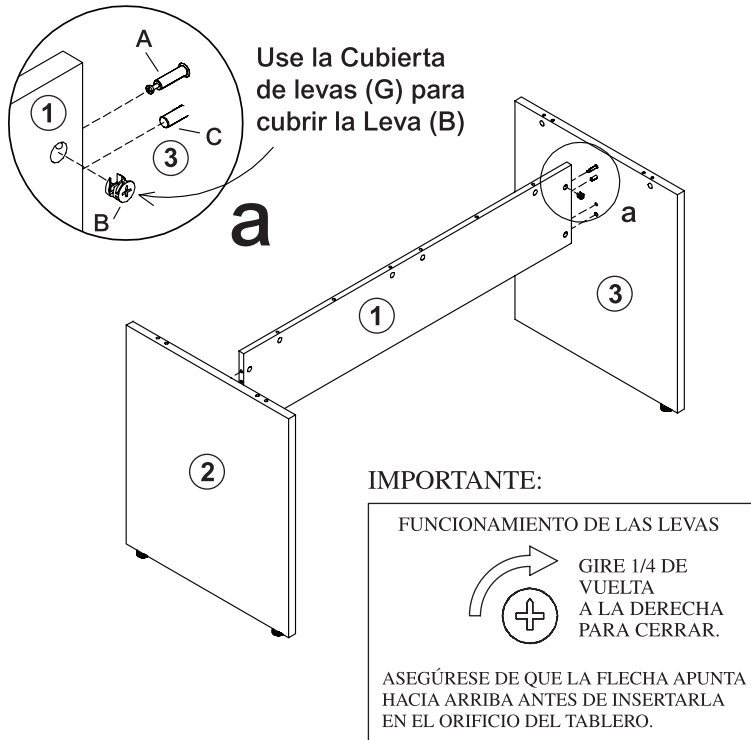

ENSAMBLE COMPLETO

**NOTA IMPORTANTE:**

- Coloque todas las partes laminadas sobre una superficie limpia y uniforme (como un tapete o la alfombra) para evitar que se rayen.
- Asegúrese de tener todas las partes y la ferretería.
- Antes de empezar a ensamblar remueva todos los materiales de empaque, incluyendo grapas y cintas.
- No apriete todos los tornillos o pernos hasta haber ensamblado todas las piezas.
- Mantenga toda la ferretería fuera del alcance de los niños.
- Se recomienda que dos personas realicen este ensamble.



## Instructions

### **CALL US FIRST! DO NOT RETURN TO STORE.**

For immediate help with assembly or product information call our toll-free number: **1-888-598-7316** Mon. - Fri. 7am to 7 pm CST  
Our staff is ready to provide assistance. Damaged or missing parts ship from our facility in 1-2 business days.

Please provide the following information:

1. Full Name
2. Physical Address – do not include P.O. Box as our carriers cannot deliver to P.O. Boxes
3. Phone Number
4. Model Number
5. Part Number
6. Invoice #
7. Date of Purchase

Note: Our policy is to send all parts requests via normal ground transportation. If your requirements are to have these parts via overnight/next day, please provide your designated carrier and account number. Replacement panels are not available. If any damage has occurred during shipment please return the entire unit to place of purchase for credit and replacement. Original invoice may be required.

Before you begin:

Open, identify and count all parts prior to assembly. Lay out the parts on a non-abrasive surface such as carpet or blanket.

## Instructions

### **APPELEZ-NOUS D'ABORD! NE REVENEZ PAS AU MAGASIN.**

Pour obtenir une aide immédiate concernant l'assemblage ou des informations sur les produits, appelez notre numéro sans frais :  
**1-888-598-7316** Lun. - vend. 7h à 19 h CST Notre personnel vous attend pour vous offrir son aide.  
Les pièces endommagées ou manquantes sont expédiées de nos locaux sous 1 à 2 jours ouvrables.

Veillez inclure les informations suivantes :

1. Nom complet
2. Adresse physique – ne pas inclure de boîte postale, car nos porteurs ne peuvent pas livrer à ces boîtes.
3. Numéro de téléphone
4. Numéro de modèle
5. Numéro de pièce
6. Numéro de facture
7. Date d'achat

Remarque : Notre politique est d'envoyer toutes les pièces demandées par transport terrestre normal. Si vous voulez recevoir ces pièces le jour suivant, indiquez votre porteur désigné ainsi qu'un numéro de compte. Nous ne fournissons pas de panneaux de rechange. En cas d'endommagement en cours de transport, renvoyez l'unité entière au lieu d'achat pour recevoir un crédit ou un échange. La facture originale vous sera peut-être demandée.

Avant de commencer:

Ouvrez, identifiez et comptez toutes les pièces avant l'assemblage. Disposez à plat les pièces sur une surface non abrasive comme un tapis ou une couverture.

## Instrucciones

### **¡LLÁMENOS PRIMERO! NO DEVUELVA EL PRODUCTO A LA TIENDA.**

Para recibir ayuda inmediata con el ensamble o información del producto, llame a nuestro número gratuito: **1-888-598-7316**  
De lunes a viernes de 7 a.m. a 7 p.m., hora del Centro. Nuestro personal está preparado para brindarle asistencia.  
Las partes dañadas o faltantes saldrán de nuestras instalaciones en el transcurso de 1 a 2 días hábiles.

Recuerde proporcionar la siguiente información:

1. Nombre completo
2. Domicilio físico – No incluya apartados postales debido a que no podemos realizar entregas en un apartado postal.
3. Número telefónico
4. Número de modelo
5. Número de parte
6. Número de factura
7. Fecha de compra

Nota: Nuestra política es enviar todas las solicitudes de partes por transporte terrestre regular. Si usted solicitó el envío de estas partes durante la noche o con entrega al día siguiente, proporcione el nombre de su compañía de mensajería y su número de cuenta. Los paneles de repuesto no están disponibles. Si ocurrió algún daño durante el envío, devuelva la unidad completa al lugar de compra para su devolución o reposición. Es posible que le pidan la factura original.

Antes de iniciar:

Abra, identifique y cuente todas las partes antes del ensamble. Coloque todas las partes en una superficie no abrasiva, como una alfombra o sábana.