

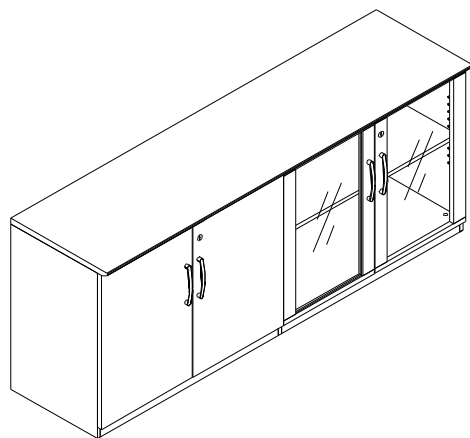

Model No.VLCC/VLCD













**Low Wall Cabinet w/o Doors/
Doors for Low Wall Cabinet**









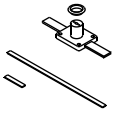

ASSEMBLY INSTRUCTIONS

CALL 1-800-822-8037 FOR ASSISTANCE









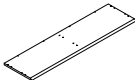

PARTS LIST

Name	Part	Qty.	Spare Qty.	Name	Part	Qty.	Spare Qty.
A		34	1	F		36	2
B		26	2	G		8	1
C		34	2	H		8	1
D		34	2	J₁		4	
E		6		J₂		4	

PARTS LIST

Name	Part	Qty.	Spare Qty.	Name	Part	Qty.	Spare Qty.
K		8	1	Q		6	
L		2		R		6	
M		8	1	S		36	2
N		4		T		4	
P		32	2	U		4	

PARTS LIST

Name	Part	Qty.	Name	Part	Qty.
V		2	a		1
W		2	b		2
X		2	d₁		1
Y₁		1	d₂		1
Y₂		1	e₁		1
Z		1	e₂		1

PARTS LIST

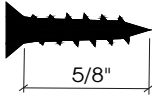
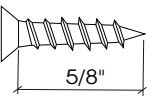
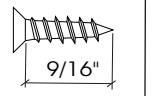
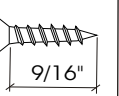
Name	F	M	P	S
Size	5/32"*5/8"	5/32"*5/8"	5/32"*9/16"	1/8"*9/16"
Part				
Color	Black	Silver	Silver	Silver

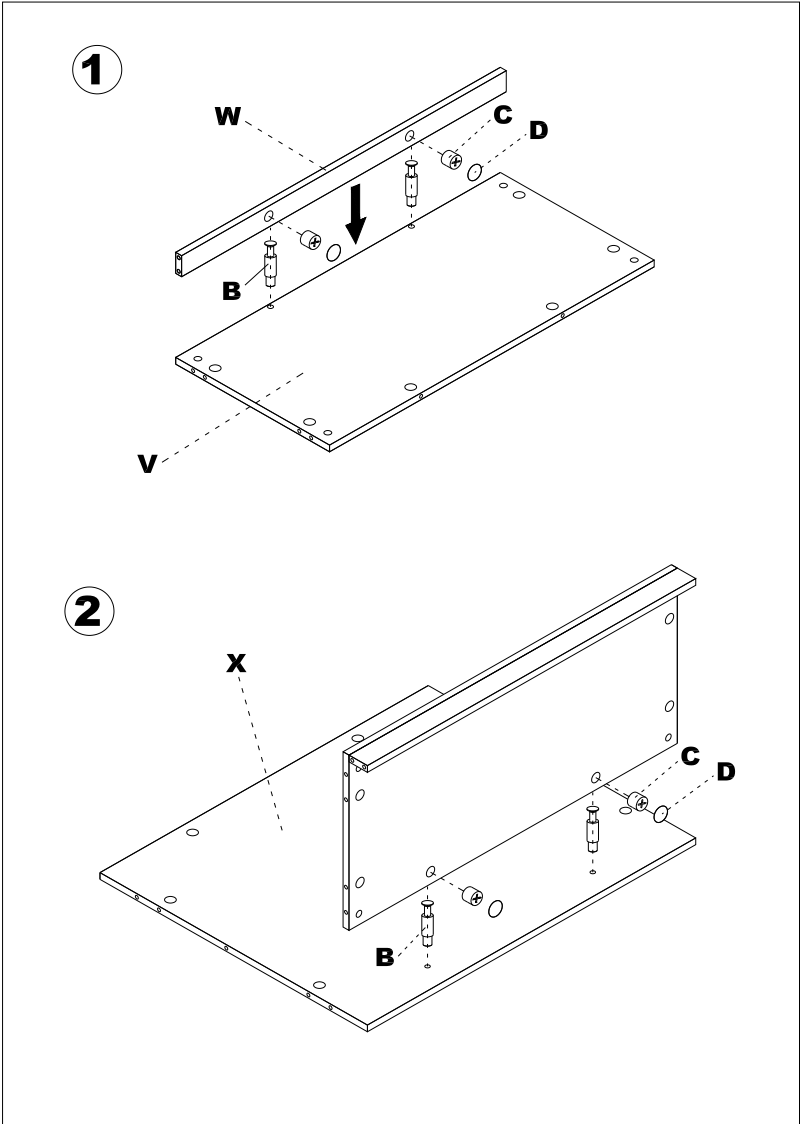

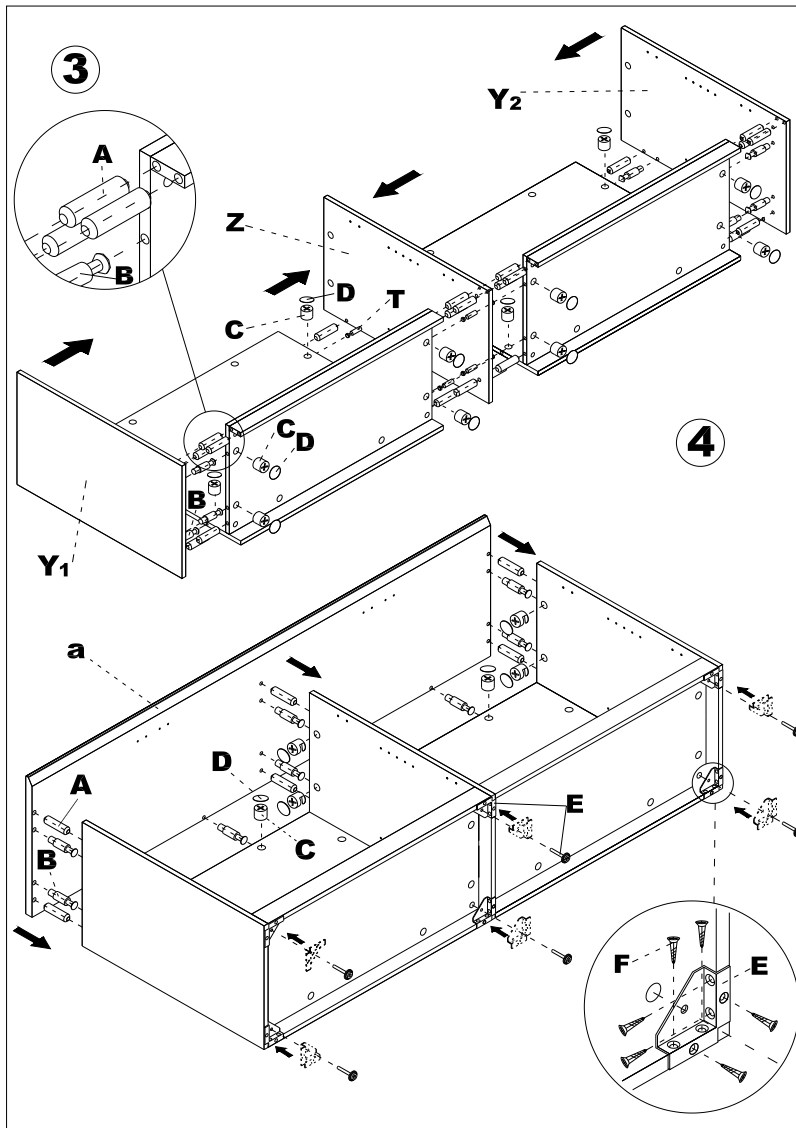

6

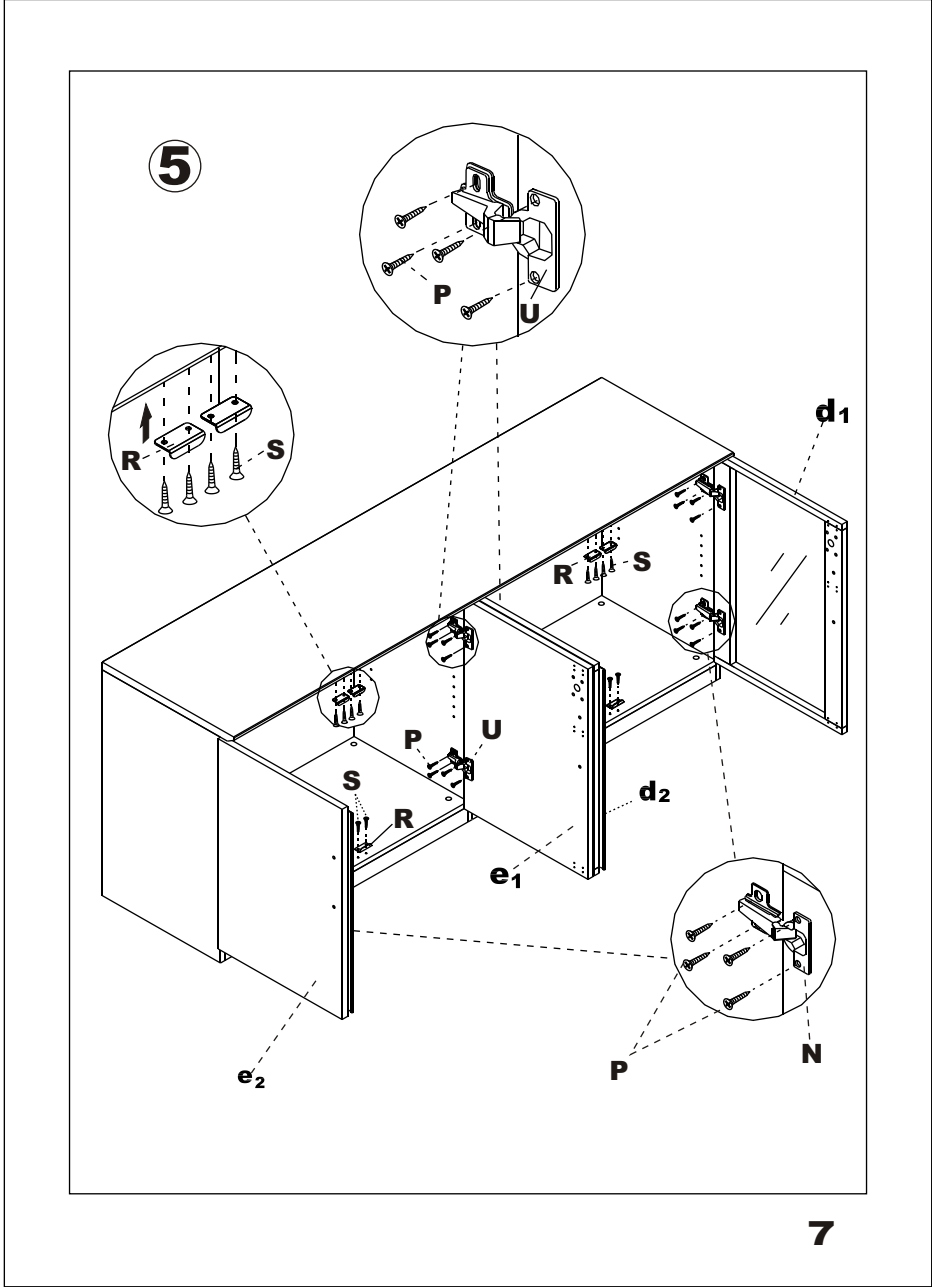

6

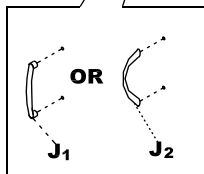
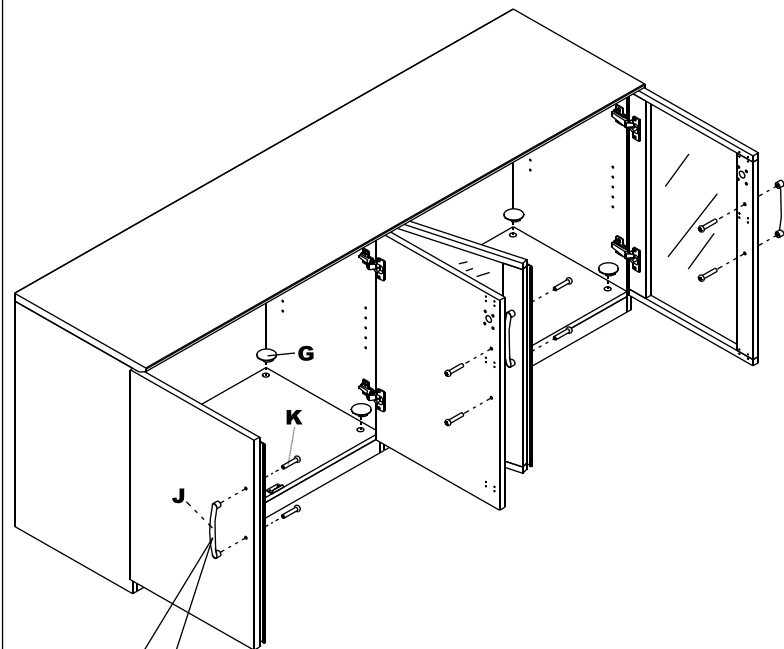

7

7

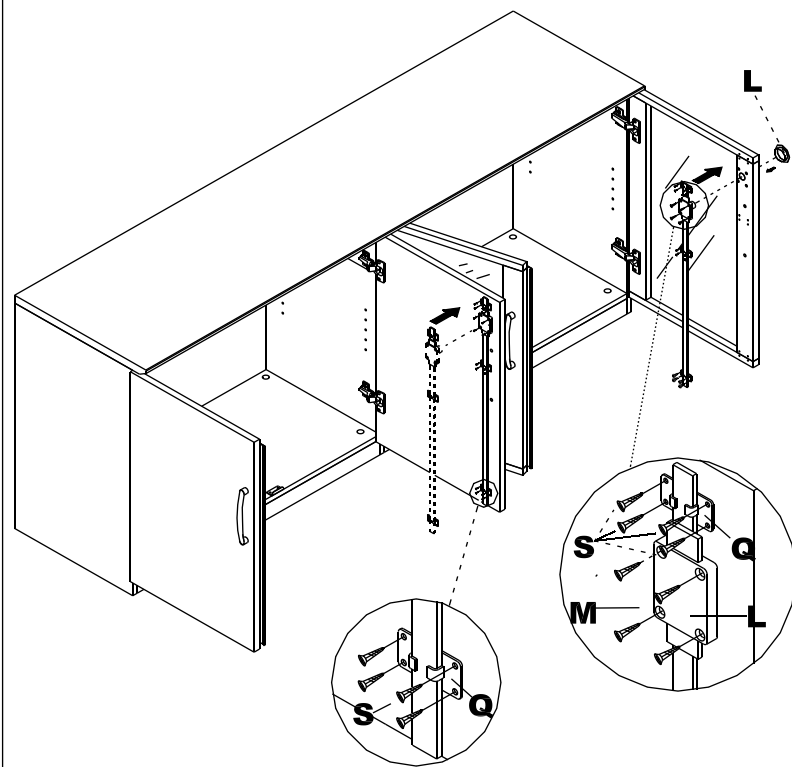

9

8

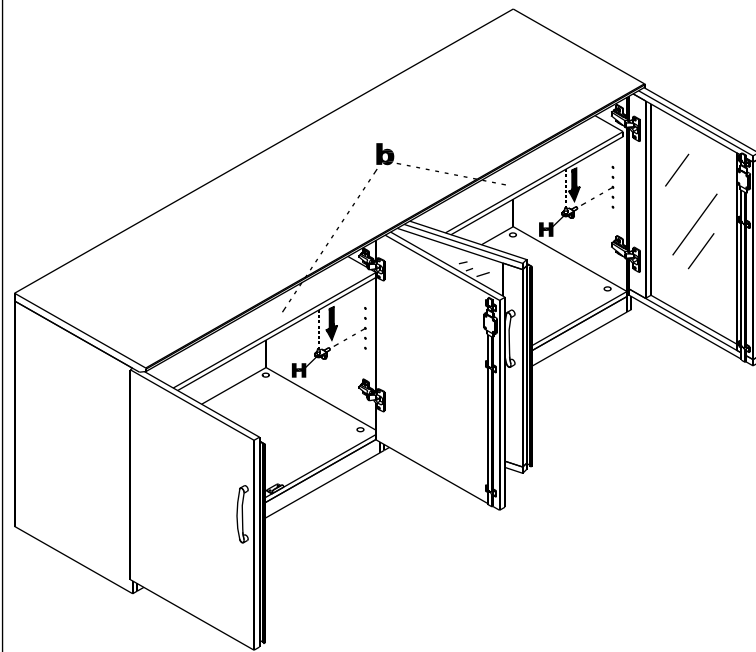

9

9

